

SP-DS5160 CUSTOM DOUBLE LIPPED STRIKE
 FOR 1-3/4" CENTER HUNG DOOR, MORTISE LOCK W/DEADBOLT, 9-1/4" FRAME

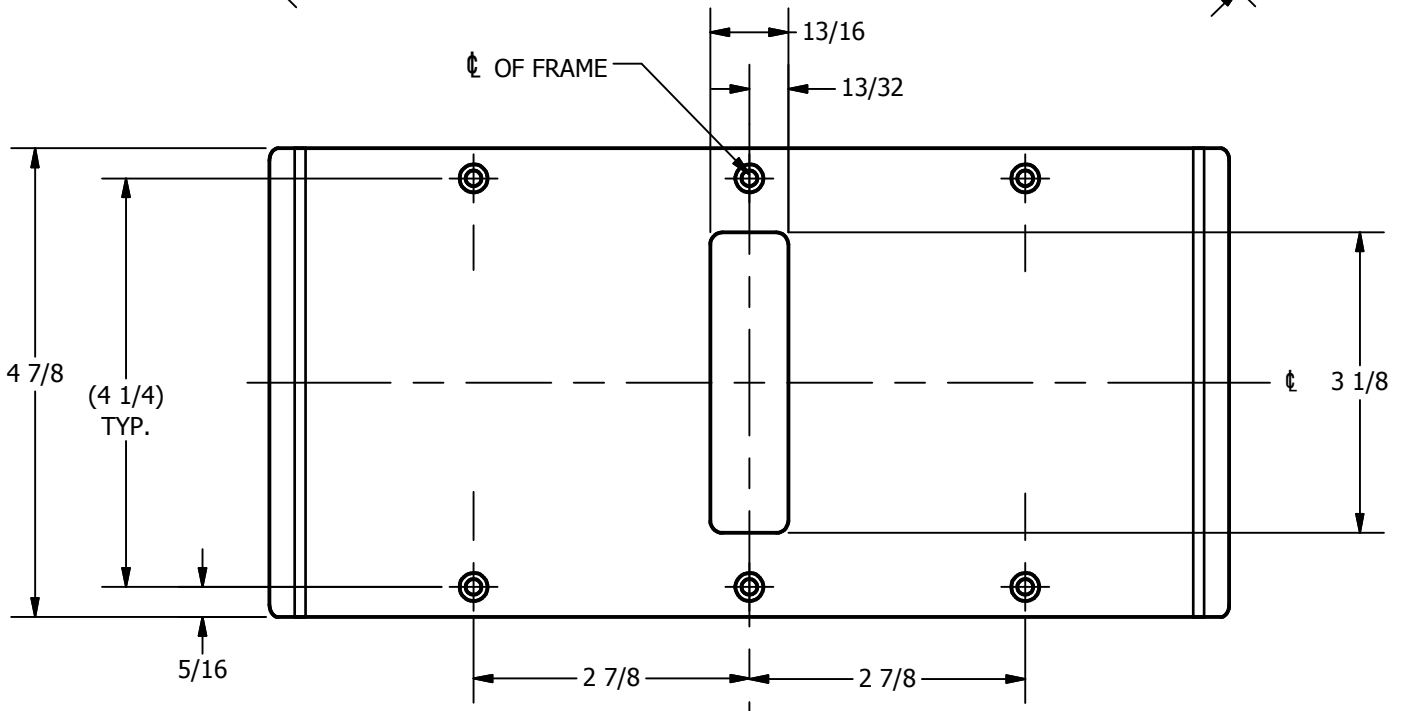

REINFORCEMENT:
 WHEN INSTALLING IN METAL FRAME, REINFORCEMENT IS **NEEDED**
 WITH THIS PRODUCT, CUSTOMER OR MANUFACTURER TO SUPPLY
 FRAME REINFORCEMENT WITH LATCH BOLT CLEARANCE

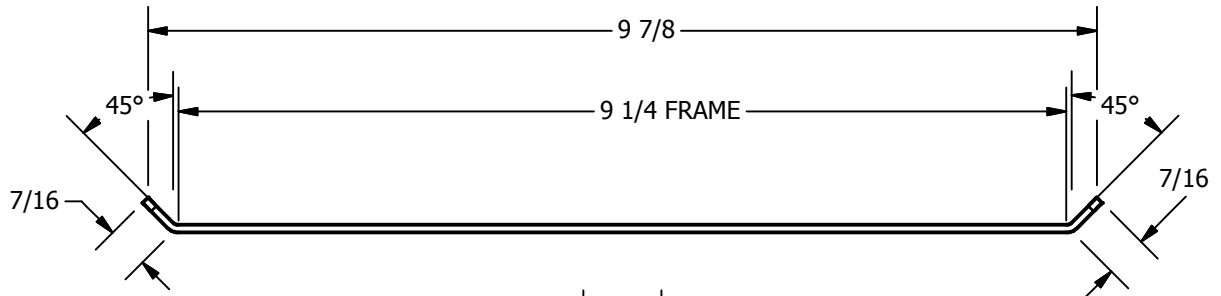
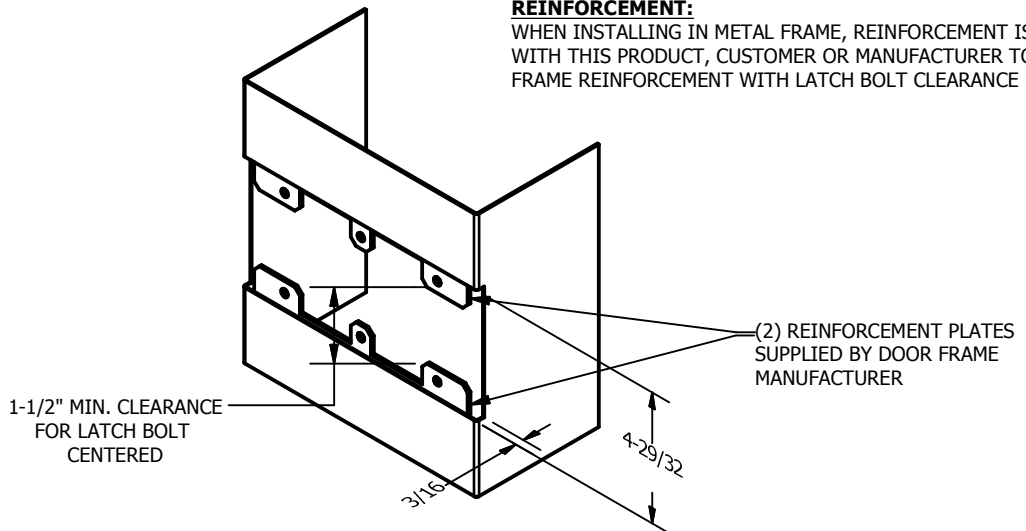

**CUT-OUT FOR
 METAL JAMB**

- NOTE:**
1. HORIZONTAL CENTERLINE OF PLATE TO MATCH HORIZONTAL CENTERLINE OF CUTOUT.
 2. SCREWS 8-32 X 3/8" UNDERCUT F.H.M.S.
 3. R.H. DOOR SHOWN, L.H. OPPOSITE

ORDER #: _____
 ORDER DATE: _____
 CUSTOMER: _____
 CUSTOMER PO#: _____
 MATERIAL: _____
 QUANTITY: _____

Architectural Builders Hardware Mfg., Inc.

1222 Ardmore Ave., Itasca, IL 60143
 630.875.9900; FAX 800.9FAXABH (932.9224)
 www.abhmfg.com
 Email: abhinfo@abhmfg.com