

# SP-CR1186 CUSTOM 4590 TYPE DOUBLE LIPPED STRIKE AND RESCUE STOP

FOR 1-3/4" THICK, 1/8" INSET DOOR, MORTISE LOCK W/DEAD BOLT, 8-1/4" FRAME

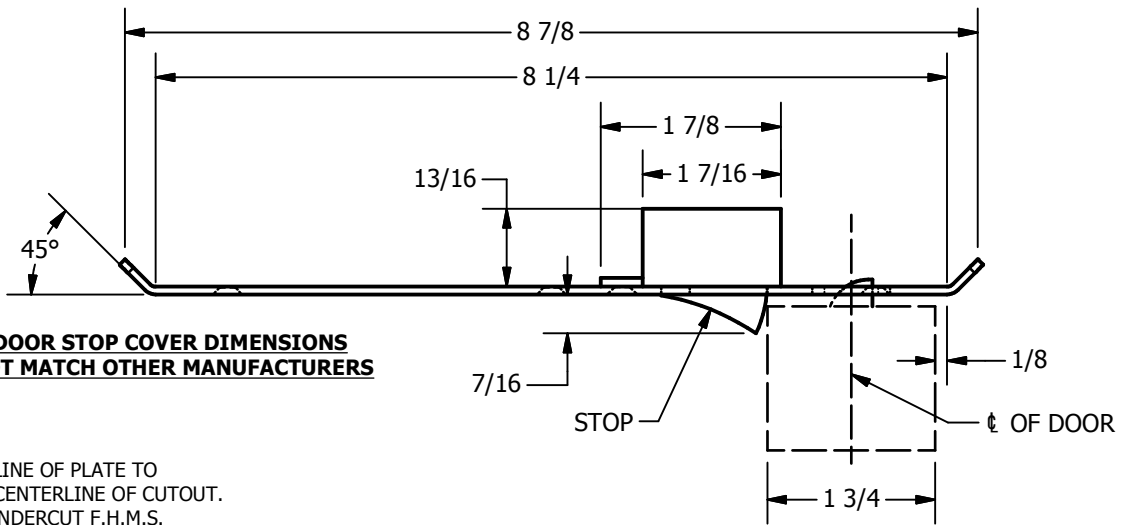

**ABH DOOR STOP COVER DIMENSIONS  
MAY NOT MATCH OTHER MANUFACTURERS**

**NOTE:**

1. HORIZONTAL CENTERLINE OF PLATE TO MATCH HORIZONTAL CENTERLINE OF CUTOUT.
2. SCREWS 8-32 X 3/8" UNDERCUT F.H.M.S.
3. R.H. DOOR SHOWN, L.H. OPPOSITE

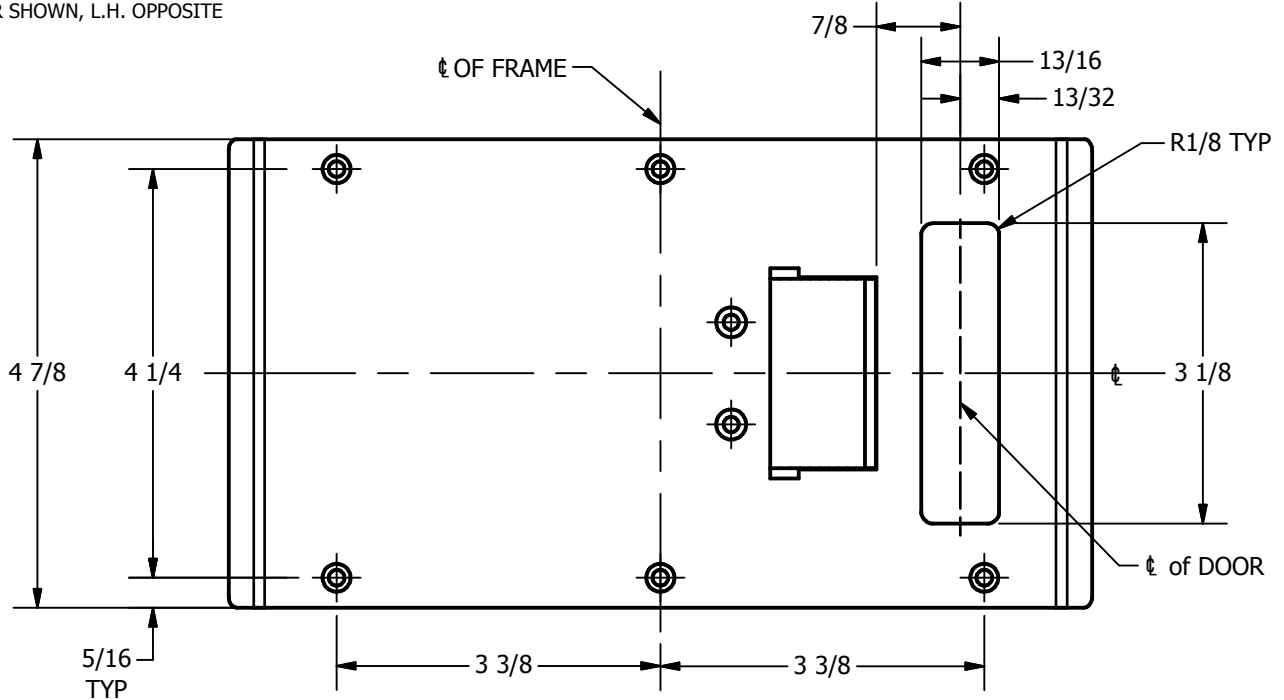

**REINFORCEMENT:**

WHEN INSTALLING IN METAL FRAME, REINFORCEMENT IS **NEEDED** WITH THIS PRODUCT, CUSTOMER OR FRAME MANUFACTURER TO SUPPLY FRAME REINFORCEMENT WITH LATCH BOLT CLEARANCE

2-5/16  
MIN. CLEARANCE  
FOR DOOR STOP COVER  
CENTERED

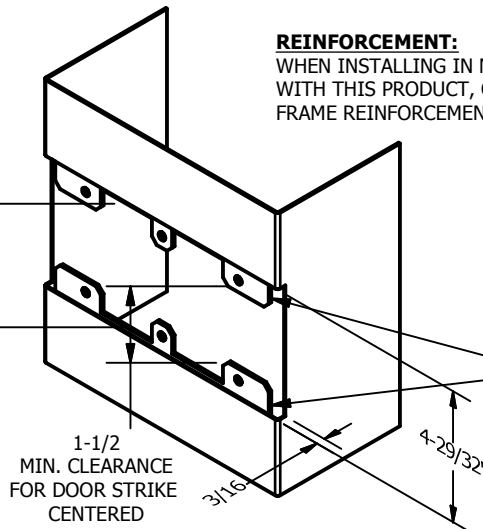

(2) REINFORCEMENT PLATES  
SUPPLIED BY DOOR FRAME  
MANUFACTURER

ORDER #: \_\_\_\_\_  
 ORDER DATE: \_\_\_\_\_  
 CUSTOMER: \_\_\_\_\_  
 CUSTOMER PO#: \_\_\_\_\_  
 MATERIAL: \_\_\_\_\_  
 QUANTITY: \_\_\_\_\_

**CUT-OUT FOR  
METAL JAMB**

**Architectural Builders Hardware Mfg., Inc.**

1222 Ardmore Ave., Itasca, IL 60143  
 630.875.9900; FAX 800.9FAXABH (932.9224)  
 www.abhmfg.com  
 Email: abhinfo@abhmfg.com