

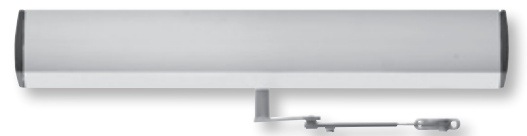

LCN®

Price book 7

Effective May 4, 2019 - Rev. 5/19



This price list supersedes and cancels all previous price lists. Prices shown are subject to change without notice.

Administrative Offices

Allegion Administrative Office
11819 N. Pennsylvania St.
Carmel, IN 46032
allegion.com/us

Placing orders

You can place orders with Allegion via the fax number or email listed below:

Fax#: 1-800-248-1460
Email: Order_LcnClosers@allegion.com

Customer Care

Our Customer Care Representatives are available for questions or assistance.
You can reach them at **877-671-7011** (Press 1 for Sales Support | Press 2 for Product Support | Press 3 for RSO) or through the email addresses listed below:

Sales Support

support@allegion.com

Technical Product Support

Closers

Closers_TechProdSupport@allegion.com

Request for Quote

Carolinas

(North Carolina, South Carolina, Virginia)
Carolinas.Quotes@allegion.com

Central

(Arkansas, Illinois, Iowa, Kansas, Missouri, Nebraska, Oklahoma)
Central.Quotes@allegion.com

Chicago

(Illinois-Northern, Wisconsin)
Chicago.Quotes@allegion.com

Florida

Florida.Quotes@allegion.com

Great Lakes

(New York, Pennsylvania)
GreatLakes.Quotes@allegion.com

Metro New York

Metro.Quotes@allegion.com

Michigan

Michigan.Quotes@allegion.com

Mid Atlantic North

(New York, Pennsylvania)
Mid.Atlantics.north.quotes@allegion.com

Mid Atlantic South

(Delaware, Maryland, New Jersey)
Mid.Atlantics.south.quotes@allegion.com

Midwest

(Indiana, Kentucky, Ohio, West Virginia)
Midwest.Quotes@allegion.com

Mountain States

(Colorado, Idaho, Montana, Nevada, Utah, Wyoming)
Mtn.States.Quotes@allegion.com

New England

(Connecticut, Main, Massachusetts, New Hampshire, Rhode Island, Vermont)
NewEngland.Quotes@allegion.com

North Central

(Minnesota, North Dakota, South Dakota)
NorthCentral.Quotes@allegion.com

Northern California

NoCal.Quotes@allegion.com

Northwest

(Alaska, Oregon, Washington)
Northwest.Quotes@allegion.com

South

(Alabama, Georgia, Louisiana, Mississippi, Tennessee)
South.Quotes@allegion.com

Southern California

(California-Southern, Hawaii)
SoCal.Quotes@allegion.com

Southwest

(Arizona, New Mexico)
Southwest.Quotes@allegion.com

Texas

Texas.Quotes@allegion.com

TABLE OF CONTENTS

Contact Information	2	Control Box Components.....	28-29
Table of Contents/How to Order	3	Actuator/Sensors Quick Find Guide.....	30-31
Available Finishes/SRI.....	4	Actuators, Sensors and Accessories.....	32--49
Order Form.....	5	Parts & Accessories	50-63
General Terms.....	6-9	Senior Swing Diagram	64
Door Closer Specialists	10	Benchmark Diagram.....	65
Complete Door Closers	11-23	Glossary of Abbreviations.....	66
Magnets.....	24	Wiring Diagrams.....	67
Specialty Products, Fasteners.....	25	Wiring Diagram Request Form.....	69
Control Boxes.....	26-27	LCN Warranty.....	71

HOW TO ORDER CLOSERS, COMPONENTS, PARTS & ACCESSORIES

1. **Identify** the closer series; 1460, 2030, 4040XP, 4210T, 4310ME, 4640, 6030, etc.
2. Determine if any **additional information** is required, such as: handing, finish, spring size, voltage, etc.
3. Order the material using suffix number with the description and include all necessary information.
Examples: 4111 Closer x RH x CUSH x AL or 4040SE Closer x 24v x DKBRZ
4. For additional information on how to order specific closers, please see the 'How to Order' page in each individual closer section of the **LCN General Catalog** or call **LCN Customer Care**.

SPECIAL NOTES

1. All **RAL** custom finishes will be powder coated and metal covers (**list add \$10 for most series, list add \$30 for 1450 and 4050 series**) will be substituted for standard covers for all closers except the 1460 series. 1460 series closers may be custom finished but a **DS** cover (**list add \$32**) must be selected.
2. **LCN** offers more than 180 **RAL** custom finishes. There is a list add of (**\$40**) per closer for an **RAL** finish. Most series require a metal cover (**MC**) (**\$10 add**). **LCN** also offers a Brite Metallic (**MTLPC**) powder coat finish. There is a list add of (**\$60**) per closer for the **MTLPC** finish.
3. **LCN** plated list prices already include -72MC (1460 includes -72DS). Disregard the additional list add for metal cover (**MC**).
4. **LCN** powder finishes exceed **ANSI/BHMA standard A156.4** for corrosion resistance by at least a factor of four. **LCN** powder coat finishes combined with the **LCN Special Rust Inhibitor (SRI)** pre-treatment exceed this standard even further.
5. **Special Rust Inhibitor (SRI)** is a pretreatment that is applied prior to the **LCN** powder coat finish and greatly exceeds **ANSI/BHMA Standard A156.4** for corrosion resistance. **LCN** requires an additional (**list add \$40**) charge per closer, component or part.
6. **LCN** plated finishes exceed **ANSI/BHMA standard A156.4** for corrosion resistance.
7. Optional **TORX** security screw packs can be substituted for standard screw packs on most closers. See '**Add for TORX Screw Pack**' for additional charge. In some cases, not all fasteners can be provided as **TORX**, consult factory for details.
8. **LCN** can mark individual closer boxes with door or opening #'s. Please specify 'itemized' when ordering. Markings (e.g., door number, stock reference numbers) on individual product cartons will be provided with no charge.
9. **Special Template (ST)** pricing is available by contacting **LCN Technical/Product Support or LCN Customer Care**.
10. All closers conform to standards **UL10C** and **UBC 7-2** (1997).
11. If an item or price is not listed in the **LCN July 9, 2018 Price List**, consult factory for availability & pricing.
12. Prices listed in the **LCN July 9, 2018 Price List** are subject to change without notice. The current '**Terms of Sale**' applies. All prices listed in the **LCN July 9, 2018** are in US dollars.

Powder Coated Finishes

LCN closers can be specified in six standard or over 180 custom powder coated finishes. Powder coating provides superior protection against the effects of weathering and provides a durable, chip resistant finish. For information about custom finishes, plated finishes and a special rust inhibiting (SRI) process, see the LCN General Catalog.

Standard Powder Coated Finishes

See LCN General Catalog, page 5 for exact colors.

- **AL (BHMA 689) - Aluminum**
- **DKBRZ (BHMA 695) - Dark Bronze**
- **BRASS (BHMA 696) - Brass**
- **LTBRZ (BHMA 691) - Light Bronze**
- **STAT (BHMA 690) - Statuary**
- **BLACK (BHMA 693) - Black**

Optional Custom Powder Coated Finishes

- **180 Custom Finishes (contact customer service for availability)**
- **Superior Appearance**
- **Environmentally Friendly Process**
- **Durable and Chip Resistant**
- **Corrosion Resistant**
- **Match Doors, Frames, and Hardware**

Optional SRI

When powder coated closers are installed in high humidity or potentially corrosive installations like swimming pools, water treatment facilities or near large bodies of water, specify LCN SRI Pretreatment. This optional process extends the corrosion protection offered by powder coat finishes.

Optional Plated Finishes

LCN offers 7 plated finishes at additional cost: US 3, US 4, US 10, US 11, US 15, US 26 and US 26D

For a list of available BAA/ARRA compliant products please contact your local RSO or sales representative to see the BAA/ARRA catalog.

ORDER FORM

Sold To: _____ Purchase Order # _____
 _____ Purchase Order Date _____
 _____ Requested Ship Date _____
 _____ Project Name _____
 _____ Shipping Instructions _____

Ship To: _____

THIS SPACE FOR FACTORY USE ONLY

Acct # _____	WOG - Y/N _____
Quantity _____	PL _____
Ship Date _____	Inv # _____
Itemize Code 1_2_3 _____	Verify _____

QTY	Closer Series	Arm Type or Part #	Description As Listed in Catalog or Parts List	Hand		Finish	
				RH	LH	Painted	Plated

Orders can be faxed to (800) 248-1460 or emailed to Order_LCNClosers@allegion.com

Terms and Conditions

Allegion General Terms and Conditions of Sale and Service

1. GENERAL/ACCEPTANCE. (a) This Agreement contains the only terms and conditions by which Company will quote and sell Deliverables to Customer; (b) The terms "purchase order" or "order" for the purposes of this Agreement include the term "request for quotation," as appropriate; (c) This Agreement supersedes all pre-printed or boilerplate terms and conditions set forth in any purchase order issued by Customer; (d) No reference herein to Customer's purchase order will in any way incorporate different or additional terms and conditions, all of which Company hereby expressly objects to; (e) **ANY ACCEPTANCE BY COMPANY OF CUSTOMER'S PURCHASE ORDER IS EXPRESSLY CONDITIONED ON THE CUSTOMER'S ASSENT TO AND ACCEPTANCE OF THE TERMS AND CONDITIONS CONTAINED IN THIS AGREEMENT;** (f) Company reserves the right to decline any order, in whole or in part, for any reason.

2. ORDERS.

a. **Order Processing.** When Customer wishes to place an order for Deliverables, it will deliver to Company a purchase order. All such purchase orders must (i) be in a written format acceptable to Company, (ii) be legible, (iii) include a purchase order number, (iv) include Customer's account number, invoice address, ship to address, shipping method, shipper's letter of instruction for international shipments, part number, pricing, and designated contact information, (v) include, if applicable, any special configuration ID numbers, necessary programming information, special factory instructions, and requested specifications regarding a particular finish, handling, design, backset, or strike, (vi) reference any applicable pricing discounts under an ongoing buying program or based on a written quote from Company, along with the applicable buying program number or quotation number, and (vii) not combine buying program and quoted product on the same order.

b. **Minimum Orders.** In the event the order value does not meet any required minimum net Deliverable value, Company may, at its sole discretion, (i) increase the quantity of items in the order to meet the minimum net Deliverable value requirement; (ii) apply a minimum order charge; (iii) reject the order, or (iv) waive the requirement, provided that the waiver of a requirement for one order shall not constitute a waiver of the requirement for any future orders.

c. **Acceptance of Purchase Orders.** Company will endeavor to (i) acknowledge receipt of each purchase order issued in accordance with this Agreement, and (ii) notify Customer whether Company accepts or rejects the purchase order. If Customer fails to accept or reject a purchase order within a reasonable time period, such failure to respond will be deemed a rejection of the entire order. Orders that combine buying program and quoted product on the same order will be routed back to your local RSO office in order to review subject purchase order.

d. **Changes to Order/ Cancellation of Orders.** Additional terms and conditions regarding order changes and cancellations are available on the Allegion customer website. **WHICH TERMS ARE EXPRESSLY INCORPORATED HEREIN BY REFERENCE.** Unless otherwise provided herein, Customer acknowledges that (i) requesting a Change Order may cause a delay in the scheduled shipment date, a longer lead time or result in a new scheduled shipment date; (ii) Orders may not be changed after 48 hours of Company's order acknowledgment; (iii) After 48 hours of Company's order acknowledgment, all changes to an accepted purchase order will be subject to a Change Order charge of 25% of the net Deliverable value, plus the cost of labor and fabrication or raw material that Company incurred prior to the receipt of the Change Order from Customer, or that may be required due to the Change Order; (iv) the requested change may result in additional charges for labor, fabrication, and raw material, and (v) if Customer cancels an order or portion of an order that includes Deliverables that have been manufactured and prepped for shipping, a 45% restocking fee will apply. Notwithstanding the foregoing, Customer cannot change or cancel credential orders, reader orders, biometrics orders or any non-cataloged, special, custom or nonstandard items once they have been placed. All cancelled orders for a Non Recurring Expense (NRE), credential orders, reader orders, biometrics orders, and/or Custom orders will be subject to a cancellation charge of 100% of the acknowledged price.

e. **Add-ons.** Add-on orders will not be accepted. Additions to orders will be entered as separate stand-alone orders and must qualify for all terms of sale, including discounts, on an individual basis.

f. **Fast-Track Orders.** No changes or cancellations will be accepted on the 24-Hour Fast Track Program. For 3-day Fast Track orders, changes and cancellations may only be requested by Customer within 24 hours of Company's order acknowledgment if the order has not shipped. For 5-Day Fast Track orders, changes and cancellations may only be requested by Customer if the order has not shipped and if the request is made to Company within 48 hours of Company's order acknowledgment. Return Material Authorization (RMA) for Deliverables must be processed through Fast Track Customer Service.

g. **Steelcraft Orders.** For all Steelcraft orders, changes or cancellations are allowed without penalty only if made within 48 hours of Company's order acknowledgment, and provided that the order has not shipped. Some exceptions do apply – please consult the factory. Changes are not allowed on Rapid Program orders after the order has been entered and acknowledged. After 48 hours of Company's order acknowledgment, all changes or cancellations are subject to a charge of 25% of the order. Unless otherwise specified by Company in writing, any changes to orders acknowledged by Company that affect the delivery date will be deemed a new order and will require acknowledgement by Company as provided in this Section. Additional products, features, terms and conditions regarding the Rapid Program are available on the Allegion customer website, **WHICH TERMS ARE EXPRESSLY INCORPORATED HEREIN BY REFERENCE.**

3. PRICES, INVOICES AND PAYMENT.

a. **Prices.** The prices in Company's Price Book are subject to change at any time, without notice to Customer. Company may charge Customer additional amounts if Customer requests special packing, marking, shipment, product modification, or engineering services. Oral prices specified by Company are null and void. Quote numbers must be referenced on Customer's purchase order in order for the Company's quoted pricing to apply. Orders that do not reference a quote number will receive buy program pricing or book net pricing. Quoted prices are for those specific products quoted for a specified job, and are subject to the Price Book in effect at the time Company receives the order.

b. **Taxes.** Prices do not include any present or future federal, state or local property, license, privilege, sales, use, excise, gross receipts or other like taxes or assessments which may result from transactions or any services performed in connection therewith. Any taxes, charges, or duties imposed by any governmental authority on the sale of Deliverables will be paid by Customer, in addition to the selling price specified by Company. Credits for U.S. sales tax applied to invoices will only be granted if valid exemption documentation is provided within 30-days of the invoice date and a case is initiated by customer service. Exemption documentation may be emailed to sales.tax.certificates@allegion.com, this e-mail address cannot be used to request a credit for sales tax charged all such requests must be made with customer service. All certificates sent to the e-mail address must include the following information: (1) Customer account number(s); (2) Customer name; and (3) Allegion brand(s) the certificate should be applied to.

c. **Payment Terms.** Company will deliver to Customer an invoice with each shipment of Deliverables hereunder. Customer will pay all invoiced amounts within 35 days of the invoice date (subject to any early pay discounts that may be offered to Customer by Company in its sole discretion). Customer will make all payments in United States dollars. Past due invoices will be subject to a late payment service charge of 1.5% per month on any overdue unpaid balance, equivalent to 18% per annum, or the maximum rate permitted by law, whichever is less. Customer shall reimburse Company for all costs of collection, including, without limitation, reasonable attorneys' fees, for any overdue amount owed by Customer to Company, and such collection costs shall also be subject to interest charges.

4. QUOTATIONS.

a. **Project Quotations.** Project or new construction quotes are restricted to the specific project quoted for the quantities, finishes, and series of Deliverables referenced on the quote. Company reserves the right to require proof of sale of Company products for any quoted project.

b. **Stock Quotations.** Deliverables fulfilling stock quotations may only be used for the following: i) Stocking of the Customer's shelves for small, quick-turn, discretionary projects, or ii) Sale to a general contractor or installer for new construction. Stock quotations may not be used for any project containing any Company no-substitution, specified products. Deliverables purchased under Stock Quotations cannot be redistributed to other Customer branch locations or re-sold to other resellers or used for aftermarket sales, end-user annual contracts or sold over the counter to any walk in trade.

c. **General.** All quotes are subject to this Agreement, unless otherwise specified by Company, and are subject to change at any time prior to Company's acceptance of a purchase order referencing the applicable quote number. Company, its representatives and employees reserve the right, in their sole discretion and for any reason, to refuse a Customer's request to quote a price other than the standard list price, regardless of whether Company or its representatives or employees have previously quoted discounted prices to the Customer on some or all of its orders. Customer's failure to comply with this Section 4 will be considered a material breach of this Agreement, and will entitle Company to immediately terminate any purchase orders and/or Customer's ability to distribute Company's products.

5. SECURITY INTEREST. Customer grants Company, and Company retains, a purchase money security interest and lien on any and all of Customer's rights, title and interest in each Deliverable sold by Company to Customer, wherever located, until the invoice for the applicable Deliverable(s) is paid in full, including any late charges and costs of collection. Customer authorizes Company to, and will assist Company in, taking all necessary steps to perfect and maintain Company's interest in such Deliverables.

6. CREDIT TERMS. Unless Customer pre-pays all of its purchase orders in advance, its purchase orders will be subject to the credit limit and other terms of credit ("Credit Terms") set forth in Company's credit application, which Credit Terms Customer acknowledges are subject to change by Company at any time. Company reserves the right to request payment in advance of shipment or any order or to request adequate assurances for Customer's payment of an order and may withhold or stop shipment, without any liability to Company, until Customer submits payment or adequate assurance of payment.

7. RE-SALE OF DELIVERABLES. Customer agrees and warrants that it will offer Company products in support of Company-written specifications and will maintain sufficient inventory to adequately support End Users, installers, and/or general contractors' needs. Company may implement an MSRP or a resale pricing programs at any time in its sole discretion. Failure to comply with such program(s) will be considered a material breach of this Agreement, and will entitle Company to immediately terminate any purchase order and/or Customer's ability to distribute Company's products. Customer shall, at its own expense, gain and maintain sufficient knowledge of the industry and products competitive with Deliverables so as to be able to (a) explain in detail to End Users, installers, and/or general contractors the differences between the Deliverables and competing products, (b) ensure that an adequate number of trained, capable and qualified technical personnel with sufficient knowledge of the Deliverables and who have obtained all necessary licenses and permits are available to assist End Users, installers, and/or general contractors, and (c) respond to such End Users, installers, and/or general contractors with respect to the general operation and use of the Deliverables including, but not limited to, (1) acting as a liaison between the End Users, installers and/or general contractors and Company in matters requiring Company participation, (2) providing general product information and configuration support on standard protocols and features, (3) collecting relevant technical problem identification information, and (4) posting and distributing any warranty information concerning the Products in accordance with Company's instructions. Customer is responsible for all service and support resulting from the re-sale of any Deliverable to End-Users, installers and/or general contractors, examples of which may include, but are not limited to, support activities such as installation, initialization, software set-up, training, trouble-shooting, technical support and field service. In the event Customer is unwilling or unable to perform said support activities, Company reserves the right to recover from Customer any and all expenses incurred by Company to resolve the afore-mentioned End-User, installer and/or general contractor issues. Technical product training is recommended for Customer in order to fully service and support Deliverables purchased from Company that are resold to End-Users, installers and/or general contractors.

8. DEFAULT. If Customer is in default of payment or otherwise with respect to any purchase order or other contract with Company, Company shall have the right, in addition to all other legal remedies and without prejudice to any of its right hereunder, to defer further shipments under that or any other purchase order until such default is corrected and to declare all outstanding bills of Customer to be immediately due and payable.

9. INSPECTION AND DELIVERY.

a. **Inspection.** Customer will inspect all Deliverables immediately after receiving them. Customer will be deemed to have accepted the Deliverables unless Customer notifies Company in writing of any nonconformance within 10 days of delivery and provides Company written evidence reasonably documenting that nonconformance. Inspection of Deliverables at Company's facility is not permitted.

b. **Delivery.** Delivery schedules for Deliverables are based upon current production capacities, material or component availability, and inventory, and may be changed by Company as conditions require. Delivery schedules for services are based upon Company's prompt receipt of, and prompt access to, Customer's equipment and all information necessary to complete the services. In no event will any delivery date be construed as falling within the meaning of "time is of the essence." Partial delivery shall be accepted by Customer and paid for at the price and on the terms stated herein. Any partial delivery shall constitute a separate sale, and payment shall be separately made when due. If any part of a delivery hereunder is not delivered by Company in accordance with Customer's purchase order, this Agreement shall not be affected thereby.

10. TITLE & RISK OF LOSS. Unless otherwise specified by Company, (i) where the Customer is located in the United States, all Deliverables will be sold "Uniform Commercial Code, FOB Origin, Company's factory"; and (ii) where the Customer is located outside of the United States, all Products will be sold "Ex-works, Company's factory (Incoterms 2010)." In either instance, title and risk of loss will pass to Customer upon delivery to the carrier at Company's factory, provided, however, as set forth herein, Company shall retain a security interest in the Deliverables until full payment has been made therefore, and Customer agrees, upon request, to do all things and acts necessary to protect Company's interest by adequately insuring the Deliverables against loss or damage from any cause and to have Company named as an additional insured. Customer will promptly provide Company with a copy of the relevant certificate of insurance upon Company's request.

11. SHIPPING.

- a. **Freight Charges.** Company will ship all Deliverables in accordance with Company's freight shipment guidelines, which are set forth on the My Allegion Portal ("Freight Shipping Guidelines"), **WHICH TERMS ARE EXPRESSLY INCORPORATED HEREIN.**
- b. **Rush Charges.** Expedited order options are available as set forth in Company's Freight Shipping Guidelines.
- c. **Packing and Marking.** Company will pack, mark, and ship Deliverables according to its standard procedures for shipment, unless the parties agree, in writing, that Company will comply with any special instructions provided by Customer. Special instructions may result in an increased price.
- d. **International Shipments.** For all international orders, a Shipper's letter of instruction must be submitted in writing with the order. Failure to do so will result in the order being rejected. Complete adherence to this order requirement will be strictly enforced. Company will not be held liable for any charges resulting from delays due to lack of complete required information being supplied.
- e. Once received by the Company, a purchase order cannot be combined with any other order to increase average order size as it relates to Company's Freight Shipping Guidelines. However, for orders placed under Company's FastTrack 24 Hour/5 Day Program (available for Schlage, Von Duprin, LCN and Glynn-Johnson products); ii) FastTrack 24 Hour/3 Day Program (available for Ives products); or ProExpress (available for specific product lines stated in the ProExpress price book for Falcon, Ives, Glynn Johnson, LCN, Schlage and Von Duprin products), the applicable brands or product categories may, subject to certain order requirements identified by Company, be combined on a single order to increase average order size used in Company's Freight Shipping Guidelines.

12. CLAIMS. All claims must be submitted in writing to Company as follows: (i) All claims for prices must be submitted within thirty (30) days from the date of invoice; (ii) All claims regarding Deliverable quantity or incorrect orders must be submitted within ten (10) days from the date of delivery; (iii) All claims for damage to Deliverables (while in the care, custody, and control of Company) must be submitted within thirty (30) days from the date of invoice; (iv) All claims for loss or damage to Deliverables while in the care, custody, and/or control of a carrier will be the responsibility of Customer, unless otherwise agreed by the parties.

13. PRODUCT CHANGES. Company's product policy is one of ongoing update and revision, and accordingly, Company reserves the right to change, without notice, the design of, or the process of manufacturing, the Deliverables covered by this Agreement.

14. PRODUCT USAGE LIMITATION. Customer agrees: (i) not to sell or use a Deliverable in any manner contrary to the manner in which the Deliverable is intended to be used; and/or (ii) not to modify the design of any Deliverable for use with another product without the prior written consent of Company.

15. PRODUCT RETURNS. Unless otherwise agreed by the parties in writing, Deliverables that are correctly furnished by Company per the purchase order may not be returned unless Customer receives written authorization from Company. If returns are authorized by Company, a return merchandise authorization ("RMA") number must be provided by Company. Deliverables identified under such RMA must be returned to Company within 90 days of issuance of the RMA. Such RMA number and any accompanying RMA documents, the original invoice number, and a written explanation for the return must be included with the returned Deliverables in order for Company to inspect and approve a credit for the return. **For warranty returns,** a credit in the amount of the original purchase price will only be issued if, after Company's receipt and inspection of the returned Deliverables, Company confirms, in its sole discretion, the defect is valid and approves the return. **For non-warranty returns/convenience returns,** in the event Company approves such a return, in its sole discretion, the following shall apply: (a) the total amount of Deliverables requested to be returned shall be a minimum of \$250.00; (b) a credit will be made to Customer's account in the amount of the original purchase price less freight and a handling charge of 45% of the net material on the original invoice; and (c) only Deliverables that are new, current, standard, non-obsolete, non-specially manufactured, unused, in their original condition as at the time of sale by Company to Customer, in their original packaging and in Customer's inventory less than 180 days from the date of shipment by the Company, and not ordered as part of a master key solution may be considered by Company for return. Such credit will only be issued if, after Company's receipt and inspection of Deliverables, Company approves the return. The amount of final credit will be determined upon receipt at the factory and following Company's inspection and analysis of the condition of the returned material. Company retains the right to deny credit to anyone for any reason.

16. CONFIDENTIAL INFORMATION.

- a. **Non-Use And Non-Disclosure.** Customer shall not use the Confidential Information of the Company except for the purpose of performing its obligations under this Agreement or exercising the rights granted herein (the "Purpose"). Customer shall protect Confidential Information of the Company from disclosure and unauthorized use in the same manner that it protects its own Confidential Information, but in no event shall such standard of care be less than reasonable care. Customer may disclose Confidential Information of the Company only to its employees who require such information for the Purpose and who are subject to confidentiality obligations at least as protective as those set forth herein.
- b. **Proprietary Information and Advice.** (a) All designs, data, and specifications provided by Company are proprietary and may not be disclosed or reused by Customer without the prior written consent of Company; (b) Company assumes no obligation or liability for any advice given by Company, the results obtained, or damages incurred as a result of such advice, and all such advice is given and accepted at Customer's risk.
- c. **Return.** Upon the termination or expiration of a purchase order or this Agreement or upon the request of the Company, the Customer agrees to end all further use of, to immediately return to the Company the original version of, and to delete or destroy all copies of, any and all Confidential Information of the Company.

17. TRADEMARKS. Except as agreed to by Company in writing, Customer agrees not to (a) use Company's name in any form of publicity; or (b) use, create, register or market, directly or indirectly, in whole or in part, Company's names, logos, brands, or any other trademarks, or names that are now or may hereafter be owned by Company, as part of Customer's corporate or business name, as part of an internet domain name, uniform resource locator (URL), or in any way connected with Customer's business, trade address or other designations. Upon termination of this Agreement or upon the request of company for any reason, any use of Company's trademarks or names will be immediately discontinued.

18. LIMITED WARRANTY.

COMPANY MAKES NO OTHER WARRANTIES EXCEPT THOSE STATED IN COMPANY'S LIMITED WARRANTY IN EFFECT ON THE DATE COMPANY ACCEPTS EACH APPLICABLE PURCHASE ORDER ("LIMITED WARRANTY"). THE LIMITED WARRANTY MAY BE FOUND IN THE APPLICABLE PRICE BOOK AND ON THE ALLEGION CUSTOMER WEBSITE, WHICH TERMS ARE EXPRESSLY INCORPORATED HEREIN BY REFERENCE. COMPANY WILL MAIL CUSTOMER A HARD COPY OF THIS WARRANTY UPON CUSTOMER'S WRITTEN REQUEST. IN THE EVENT THAT CERTAIN DELIVERABLE WARRANTIES ARE NOT FURNISHED BY THE COMPANY TO CUSTOMER, COMPANY WARRANTS ONLY TO CUSTOMER THAT THE DELIVERABLES WILL BE FREE FROM DEFECTS IN MATERIAL AND WORKMANSHIP FOR A PERIOD OF 12 MONTHS FROM THE DATE OF SHIPMENT OF THE DELIVERABLES. COMPANY'S SOLE OBLIGATION UNDER THIS WARRANTY IS LIMITED TO REPAIRING OR REPLACING, AT COMPANY'S OPTION, THE DEFECTIVE DELIVERABLE, PROVIDED WRITTEN NOTICE OF THE DEFECT OR NONCONFORMANCE IS PROVIDED BY CUSTOMER WITHIN 30 DAYS OF DISCOVERY OF THE DEFECT OR NONCONFORMANCE. COMPANY DISCLAIMS ALL OTHER WARRANTIES, EXPRESS OR IMPLIED, WITH RESPECT TO THE DELIVERABLES, INCLUDING BUT NOT LIMITED TO, ANY IMPLIED WARRANTIES OF NON-INFRINGEMENT, MERCHANTABILITY, OR FITNESS FOR A PARTICULAR PURPOSE.

- a. **Exclusions.** The provisions of this Limited Warranty do not apply to Deliverables that: (A) are not the proper size for the application; (B) are not installed in accordance with Company's published installation instructions; (C) are installed with improper or incorrect parts and/or are used for purposes for which they are not designed or intended; (D) have been repaired or altered without the Company's prior written consent; (E) have been subjected to misuse, abuse, negligence or accident; (F) have been improperly stored, installed, maintained or operated; (G) have been used in violation of written instructions provided by Company to Customer; (H) have been subjected to improper temperature, humidity, or other environmental conditions, or (I) have been affected by normal wear and tear. In addition, the provisions of this Limited Warranty do not apply to any defects or issues with the design or performance of equipment or products not manufactured by Company, nor does it apply to any code compliance or permit requirements for the assembly, installation, erection or construction of any goods. Company is not responsible for loss or damage resulting from use of Deliverables in conjunction with parts or systems not manufactured by Company. Accessories or products furnished by the Company, but manufactured by others, shall carry whatever warranty the manufacturers have conveyed to the Company and which can be passed to Customer.
 - b. **Services.** Company warrants that its services will be free from defects in material and workmanship for a period of 12 months from the date of completion of the particular items of service. Company's sole obligation under this service warranty is limited to repair or reperformance, at its option of the service, provided however, if repair or reperformance is either impractical or impossible, the Company will refund to Customer that portion of the price paid to Company for any defective service, provided written notice of the defect or nonconformance is provided by Customer within 30 days of discovery of the nonconformance.
 - c. **Notification.** Customer agrees to immediately notify Company in writing if any claim is made against Customer for any damages caused by any modules, parts, products, service or other Deliverables which may be the direct result of any defect in the manufacture of such aforementioned products. Customer agrees to cooperate with Company and its counsel in the defense of such claim and Customer agrees not to settle such claim without Company's written consent. If Customer fails to notify Company of such claim or fails to cooperate in such defense as aforesaid, then Company shall be discharged from any obligations under this Section and shall have no further liability to Customer.
 - d. **Exceptions.** The following costs and expenses are not covered by the provisions of these limited warranties: (i) labor costs for the removal and reinstallation of Deliverables or other manufacturer's products; (ii) shipping and freight expenses required to return Deliverables to Company; (iii) normal maintenance; and (iv) economic losses. In addition, the provisions of this warranty are not applicable to anything other than defects in Company's material (products only) or workmanship.
- 19. LIMITATION OF REMEDIES.**
CUSTOMER'S EXCLUSIVE AND SOLE REMEDY ON ACCOUNT OF, OR IN RESPECT OF, THE FURNISHING OF NON-CONFORMING DELIVERABLES, SHALL BE TO (A) SECURE REPAIR OR REPLACEMENT OF THE PRODUCTS; OR (B) SECURE REPAIR OR RE-PERFORMANCE OF THE SERVICES OR TO OBTAIN A REFUND OF THE PRICE PAID FOR THE DEFECTIVE SERVICE, ALL AT COMPANY'S OPTION. IN NO EVENT WILL THE COMPANY'S MAXIMUM LIABILITY EXCEED THE SELLING PRICE FOR THE DELIVERABLE. THE WARRANTY, OBLIGATIONS AND LIABILITIES OF COMPANY (INCLUDING ITS SUPPLIERS) AND THE RIGHTS AND REMEDIES OF CUSTOMER ARE EXCLUSIVE AND ARE IN LIEU OF AND CUSTOMER HEREBY WAIVES AND RELEASES ALL OTHER WARRANTIES, OBLIGATIONS, REPRESENTATIONS OR LIABILITIES EXPRESS OR IMPLIED ARISING BY LAW, IN CONTRACT, TORT (INCLUDING NEGLIGENCE OR STRICT LIABILITY) OR OTHERWISE, INCLUDING BUT NOT LIMITED TO (I) ANY IMPLIED WARRANTY OF MERCHANTABILITY OR FITNESS FOR A PARTICULAR PURPOSE OR ANY WARRANTY IMPLIED THROUGH COURSE OF PERFORMANCE, COURSE OF DEALING, OR USAGE OF TRADE OR (II) CLAIMS ARISING OUT OF THE NEGLIGENCE OF COMPANY OR COMPANY'S SUPPLIERS OR (III) ANY OTHER CLAIM ARISING OUT OF, CONNECTED WITH, OR RESULTING FROM THE PERFORMANCE OF COMPANY OR FROM THE DESIGN, MANUFACTURE, SALE, REPAIR, LEASE OR USE OF THE DELIVERABLE, OR ANY COMPONENT THEREOF, DELIVERED OR RENDERED HEREUNDER OR OTHERWISE.
- 20. INDEMNIFICATION AND LIMITATION OF LIABILITY.** a. Customer shall indemnify, defend and hold Company, and its officers, directors, employees, customers, Affiliates, suppliers, users and agents, (collectively the "Indemnitees") harmless from and against any and all damages, claims, losses, expenses, costs, obligations, liabilities, including without limiting the generality of the foregoing, liabilities for court costs and attorneys' fees, suffered directly or indirectly by an Indemnitee by reason of, or arising out of any injury, death or loss to any person, or injury to any property (collectively, "Damages"), received or sustained by any person(s) or property, arising out of, occasioned by, attributable or related to i) any breach of any representation or warranty made by Customer, its officers, directors, employees, affiliates, users, agents, representatives or customers to Company or any third party, (ii) any failure by

Terms and Conditions

Customer to perform or fulfill any of its covenants, acts and/or omissions to Company or to any third party, or (iii) any litigation, proceeding or claim by any third party relating in any way to the obligations of Customer and/or the Deliverables sold by Company to Customer hereunder. Customer shall not consummate any settlement of any indemnified claim without the Indemnitees' prior written consent. Customer's obligation to indemnify Indemnitees will continue in full force and effect notwithstanding the termination or expiration of any order under this Agreement. In any claim against an Indemnitee by an employee of Customer or any subcontractor or anyone directly or indirectly employed by any of them or anyone for whose acts they may be liable, the indemnification obligations set forth in this Section shall not be limited in any way by or for Customer or any subcontractor under any applicable worker's compensation act, disability or other employee benefit act, or insurance coverage. This provision shall survive termination of any order or Agreement. **IN NO EVENT WILL COMPANY, ITS OFFICERS, DIRECTORS, EMPLOYEES, CUSTOMERS, AFFILIATES, USERS AND AGENTS, (NOR COMPANY'S SUPPLIERS) BE LIABLE FOR ANY INCIDENTAL, CONSEQUENTIAL, INDIRECT, SPECIAL, OR PUNITIVE DAMAGES OF ANY KIND OR NATURE UNDER ANY CIRCUMSTANCES INCLUDING, BUT NOT LIMITED TO, LOSS OF USE OF THE PRODUCTS, SERVICE INTERRUPTION, LOSS OF PROFITS, LOSS OF REVENUE, LOSS OF INTEREST, LOST GOODWILL, LOSS OF DATA, WORK STOPPAGE, IMPAIRMENT OF OTHER GOODS, LOSS BY REASON OF SHUTDOWN OR NON-OPERATION, INCREASED EXPENSES OF OPERATION, OR CLAIMS OF CUSTOMER'S CUSTOMERS, OR ANY OTHER LOSSES OR DAMAGES ARISING OUT OF ANY LACK OR LOSS OF USE OF THE DELIVERABLES WHETHER BASED ON CONTRACT, WARRANTY, TORT (INCLUDING, BUT NOT LIMITED TO, STRICT LIABILITY OR NEGLIGENCE), PATENT INFRINGEMENT, OR OTHERWISE, EVEN IF ADVISED OF THE POSSIBILITY OF SUCH DAMAGES.**

b) **INTELLECTUAL PROPERTY INDEMNITY.** Company makes no representation or warranty to the Customer that the Deliverables shall not infringe any intellectual property rights including, without limitations, claims arising from patent, copyright, trademark, trade secret, or other intellectual property infringement. Customer agrees to hold Company harmless from and defend the Company against any such claim of intellectual property infringement, including any Damages resulting from that claim, the cost of complying with any preliminary or permanent injunction, and all other costs of defense (including the attorneys' fees and costs), in connection with the foregoing.

c) To the extent that applicable law does not permit any limitations set out in this Agreement, such limitation shall not be applied or invoked. Nothing in this Agreement will be interpreted to disclaim liability of Company or the Indemnitees for gross negligence or willful misconduct. The limitations of remedy and liability herein shall not be interpreted to affect Company's obligations, if any, for claims for (i) property damage, (ii) personal injury, or (iii) wrongful death asserted by persons who are not parties to or beneficiaries of this Agreement. Further, the limitations of remedy and liability herein shall not be interpreted to limit Company's or Customer's right, if permitted by applicable law, to assert a claim for contribution among joint tortfeasors in connection with a claim by a person who is not a party to this Agreement.

21. CERTIFICATIONS. Certification of Deliverables for compliance with UL and ANSI standards are tested and performed by third-party independent laboratories. Any field modification or alteration of certified Deliverables will void certification and Company is not liable to Customer to certify any modified or altered Deliverable.

22. TERM FOR CLAIMS. NO ACTION ARISING OUT OF ANY CLAIMED BREACH OF THIS AGREEMENT BY COMPANY MAY BE BROUGHT BY CUSTOMER MORE THAN ONE (1) YEAR AFTER THE CAUSE OF ACTION HAS ARISEN.

23. CONSUMER PRODUCTS

WITH RESPECT TO "CONSUMER PRODUCTS" AS DEFINED UNDER THE MAGNUSON-MOSS WARRANTY ACT ("MMWA"), THE FOLLOWING STATEMENTS ARE MADE. (A) SOME STATES OR LOCAL LAWS DO NOT ALLOW LIMITATIONS ON HOW LONG AN IMPLIED WARRANTY LASTS, SO THE ABOVE LIMITATION MAY NOT APPLY TO YOU; (B) IF ANY IMPLIED WARRANTY IS PROVIDED UNDER THE MMWA, IT IS LIMITED TO THE DURATION OF THE WARRANTY PROVIDED IN SECTION 18 ABOVE. (C) SOME STATES OR LOCAL LAWS DO NOT ALLOW THE EXCLUSION OR LIMITATION OF INCIDENTAL OR CONSEQUENTIAL DAMAGES, SO THE ABOVE LIMITATION OR EXCLUSION MAY NOT APPLY TO YOU; AND (D) THIS WARRANTY GIVES YOU SPECIFIC LEGAL RIGHTS AND YOU MAY ALSO HAVE OTHER RIGHTS WHICH VARY FROM STATE TO STATE OR LOCATION TO LOCATION.

24. FORCE MAJEURE/EXCUSABLE DELAY. Any delay or failure of Company to perform its obligations hereunder will be excused to the extent that it is caused by an event or occurrence beyond Company's control such as, by way of example and not by way of limitation, acts of God, acts by any governmental authority (whether valid or invalid), governmental laws and regulations not presently in effect, fires, floods, windstorms, explosions, riots, natural disasters, wars, sabotage, accidents, labor problems (including, without limitation, lockouts, strikes, and slowdowns) at Company's facility, its source plant or their suppliers, inability to obtain power, material, labor equipment, or transportation, or court injunction or order. The delivery date will be extended for a time equal to that of the delay and the schedule for Company's performance will be deemed adjusted to that effect.

25. ENTIRE AGREEMENT AND AMENDMENT. This Agreement, together with the attachments, exhibits, webpages, or supplements specifically referenced and incorporated herein, constitute the entire agreement between Company and Customer with respect to the matters contained herein and supersede all previous communications, representations, or agreements, either oral or written between Company and Customer. No agreement or understanding varying or expanding this Agreement will be binding upon either party unless it is in writing and signed by a duly authorized representative of each party hereto.

26. CONFLICTS. In the event of any conflict or inconsistency between the terms of any agreement, or any part of an agreement or the various documents (including, but not limited to, electronic documents) between Company and Customer, unless the parties agree otherwise in writing, the various components of the agreements shall be given the following precedence (in descending order of precedence): a) any master agreement or long term agreement between Company and Customer; b) any specific terms, conditions and/or warranties of the individual products or Deliverables; c) the terms and conditions of this Agreement, and d) any purchase order.

27. UNSATISFACTORY CREDIT/TERMINATION FOR INSOLVENCY OR DEFAULT.

Customer shall furnish Company with statements evidencing Customer's financial condition as Company may, from time to time, reasonably request, and shall notify Company immediately of any and all events that may have a material adverse effect on Customer's business or financial

condition. If Company determines, in its sole discretion, that Customer's financial condition or creditworthiness is inadequate or unsatisfactory, then in addition to Company's other rights, Company may without liability or penalty, take any of the following actions: (i) modify the payment terms for any outstanding and/or future purchases; (ii) cancel any previously accepted orders; (iii) delay any further shipment of Deliverables to Customer; or (iv) any combination of the above.

Company may immediately terminate an order from Customer by giving written notice to Customer in the event of the happening of any of the following or any other comparable event: (i) insolvency of the Customer; (ii) filing of a petition in bankruptcy by or against the Customer; (iii) appointment of a receiver or trustee for the Customer; (iv) execution of an assignment for the benefit of creditors by the Customer, all of which will allow Company to demand reclamation of all affected orders; (v) Customer ceases or threatens to cease to trade; (vi) Company determines that Customer does not meet or no longer meets the credit requirements of Company or Customer's credit account is closed; (vii) any Customer violation of law, specifically including, without limitation, those laws set forth in this Agreement.

In the event of termination in accordance with this section, Company will not be obligated to accept any existing or additional orders from Customer and Company will be released from its obligation to deliver under orders accepted prior to such termination. The rejection or termination of any order by Company will not entitle Customer to any termination or severance compensation, or to any payment in respect to any goodwill established by Customer, or render Company liable for damages on account of the loss of prospective profits, or on account of any loss, expenditure, investment or obligation incurred or made by Customer.

No action taken under this Section 27 by Company (nor any failure of Company to act under this Section 27) will constitute a waiver by Company of any of its rights to enforce Customer's obligations, including the obligation of Customer to make payments as required under this Agreement. Upon termination of any order, all amounts owed by Customer to Company will become immediately due and payable, whether or not otherwise then due or payable.

28. CREDIT RISK ON RESALE OF DELIVERABLES. Customer is responsible for all credit risks with respect to, and for collecting payment for, all Deliverables sold to third parties (including End Users, installers, and/or general contractors) whether or not Customer has made full payment to Company for such Deliverables. The inability of Customer to collect payment for any Deliverable shall not affect Customer's obligation to pay Company for any Deliverable.

29. GOVERNING LAW; VENUE; AND EXPENSES. Any dispute or claim relating to this Agreement shall be governed by and construed according to the laws of the State of Indiana (excluding its conflict of laws principles); and not by the provisions of the 1980 United Nations Convention on the International Sale of Goods. Any disputes or claims shall be instituted and maintained in the courts of the State of Indiana. Customer consents to the exercise of jurisdiction over it by such courts and agrees that Indiana is not an inconvenient forum for any action arising from or relating to this Agreement. Customer agrees to pay for all expenses (including, but not limited to, collection costs, court costs and attorneys' fees) incurred by Company in enforcing the obligations of Customer under this Agreement.

30. RELATIONSHIP OF THE PARTIES. Nothing in this Agreement or any other document creates an employment, partnership, joint venture, or agency relationship between Company and Customer, including that of franchisee/franchisor. No party will have any power or authority to enter into any commitment on behalf of or otherwise bind the any other party on any matter. No employee of Customer will be deemed to be an employee of Company. If any provision of this Agreement is deemed to create a franchise relationship or business opportunity between the Parties, then Company may terminate any purchase order or this Agreement or the Parties shall negotiate in good faith to modify this Agreement so as to effect the original intent of the Parties as closely as possible in a mutually acceptable manner in order that the transactions contemplated hereby are consummated as a reseller agreement and not a franchise or business opportunity agreement.

31. SETOFF. Customer does not have the right to setoff or to back charge against any amounts which become payable to Company under this Agreement or otherwise. Company will not accept responsibility for backcharges for the cost of material or labor by Customer or any third party.

32. ELECTRONIC COMMUNICATIONS AND ELECTRONIC SIGNATURES. Both parties expressly agree to electronic transactions and acknowledge that documents they sign electronically will bind them to the same extent as a paper signature. Customer represents and warrants to Company that only employees authorized to bind Customer legally shall electronically sign any document under this Agreement. Customer shall comply with any method of electronic communication/payment processing specified by Company, including electronic funds transfer, pay-on-receipt processes/systems, order transmission, releases, electronic signature, and electronic communication systems, including, without limitation, the use of electronic data interchange ("EDI") portals. Notwithstanding the foregoing, e-mails, even those containing a signature block of one of Company's representatives, shall not constitute a signed writing.

33. COMPLIANCE WITH APPLICABLE LAWS.

a. General. Company and Customer will comply with all applicable federal, state and municipal laws, regulations, codes, ordinances and orders that pertain to the Deliverables, including but not limited to full compliance with any applicable provisions of The Health Insurance Portability and Accountability Act. Where the Customer is located outside the United States, or where the customer intends to ship the product outside the United States, the Customer shall be responsible for compliance with all U.S. export laws, and for filing all U.S. Electronic Export Information, as applicable.

b. The Customer acknowledges and agrees that: (i) it shall not violate applicable laws and regulations in performing its duties under this Agreement; (ii) it does not and shall not engage in any conduct that shall violate any applicable anti-bribery or anti-corruption laws or regulations; (iii) it (and its owners, officers, directors, employees and agents) shall not pay, offer, promise or authorize the payment of, either directly or indirectly, anything of value (including but not limited to cash, gifts and entertainment) to (a) any government official or employee of any government; (b) any official or employee of any department, agency, or instrumentality of a government; (c) any employee of any corporation or entity owned or controlled by a government; (d) any family member of such officials or employees; (e) any political party, party official, or political candidate; or (f) any other persons, owners, officers, directors, employees and agents of any corporation or entity; to improperly or illegally assist in obtaining or retaining business (including but not limited to any contracts, avoidance of duties or reduction of tariffs, reduction of taxes or

to obtain money owed, or to obtain regulatory approval) or for the purpose of causing, soliciting or inducing the sale and purchase of the Deliverables by any party, and (iv) it has full knowledge of and will comply with the Company's Code of Conduct for Business Partners as set forth on the Allegion customer website. **WHICH IS HEREBY INCORPORATED BY REFERENCE.**

c. The Customer shall indemnify and hold the Company harmless from any claim, demand, expense or cost arising from any breach of this Article.

d. The Customer shall permit the Company to conduct an audit or review of the Customer's financial books and records and business operations at such other times that the Company considers it necessary to confirm compliance with this provision. Such audit may be conducted by representatives of the Company or, at the Company's sole discretion, by a certified public accounting firm selected by the Company. The Customer shall cooperate with any inquiries from the Company's Ethics & Compliance Group.

e. A violation of this provision constitutes a material breach of this Agreement and the Company may terminate any purchase order or this Agreement immediately, with no opportunity to cure, in accordance with Section 27 of this Agreement.

f. Notwithstanding the foregoing provisions of this Section 33, (i) Company is not responsible for obtaining or maintaining any permits for the performance of services or the verification or compliance with any code requirements relative to the performance of services, (ii) to the extent any sale of Deliverables pursuant to this Agreement may require approval of the U.S. Government, Company's obligations under this Agreement are conditioned upon the grant of such approval and upon compliance by Customer with any restrictions imposed by the U.S. Government in connection with such approval, and (iii) in the event the Deliverables are to be used in a nuclear facility, the Customer shall, prior to such use, arrange for insurance or governmental indemnity protecting Company against liability. The Customer hereby releases and agrees to indemnify Company and its suppliers for any nuclear damage including, but not limited to, loss of use, in any manner arising out of the nuclear incident, whether alleged to be due, in whole or in part by Company or its suppliers.

g. **No Inducements.** Each party represents to each other that neither it nor any person acting on its behalf has, in contravention of any applicable law, given or offered to give or will give or offer to give, any sum of money or other material consideration to any person, directly or indirectly, as an inducement to obtain business hereunder or to influence the granting of licenses or other governmental permissions to enter into this Agreement or perform obligations hereunder.

h. **Equal Employment Opportunity.** Company is a U.S. federal contractor that complies with Executive Order 11246, as amended, and applicable regulations in 41 CFR Parts 60-1 through 60-60, 29 U.S.C. § 793 and applicable regulations in 41 CFR § 60-741; and 38 U.S.C. § 4212 and applicable regulations in 41 CFR Part 60-250 and 60-300. **THE FOLLOWING PROVISIONS ARE INCORPORATED HEREIN BY REFERENCE:** Executive Order 11246, as amended by Executive Order 13672, and 41 CFR § 60-4.3(a); Executive Order 11701 and 41 CFR §§ 60-250.5(a), 60-300.5; Executive Order 11758 and 41 CFR § 60-741.5(a); U.S. immigration laws, including the L-1 Visa Reform Act of 2004 and the H-1B Visa Reform Act of 2004; and Executive Order 13496.

i. **Ethical Business Conduct.** Customer shall adopt and comply with Company's Business Partner Code of Conduct which is **EXPRESSLY INCORPORATED HEREIN BY REFERENCE.**

34. REPRESENTATIONS AND WARRANTIES. Customer represents, warrants and covenants to Company that: (a) it has the right, power, and authority to enter into this Agreement and fully perform its obligations hereunder; (b) it has all necessary rights in and to its respective Content and Marks for use within the scope of this Agreement, including the licenses granted herein; and (c) it complies, and at all times shall comply, with all laws, rules, and regulations in effect that are applicable to its performance under this Agreement, including obtaining all such approvals and/or permits as may be required hereunder.

35. NO THIRD-PARTY BENEFICIARY. Each party is entering into this Agreement solely based on the representations contained herein for its own purposes and not for the benefit of any third party.

36. NOTICES AND CHANGE OF ADDRESS. All notices or other communications under this Agreement shall be in writing and delivered in person, or sent by receipted courier, express mail, e-mail, or postage prepaid certified or registered mail, addressed to the party for whom it is intended, at the addresses set forth in this Agreement. Either party may change its address for notice by giving written notice to the other party. Any notice or other communication shall be deemed given no later than the date actually received. Notice by courier, express mail, certified mail, or registered mail shall be deemed given on the date it is officially recorded as delivered and, in the absence of such record of delivery, it shall be rebuttably presumed to have been delivered on the third Business Day after it was deposited. Notices sent by e-mail require tangible confirmation of receipt from addressee.

37. ASSIGNMENT. Customer may not assign this Agreement without the prior written consent of Company. Company may assign its rights and delegate its duties under this Agreement, without the prior consent of Customer, to an Affiliate, or to a third party in the event of a spin-off, merger, business combination, consolidation or sale of all, or substantially all, of its assets or business that are related to this Agreement. The rights and duties in this Agreement shall bind and inure to the benefit of any such assignee.

38. SEVERABILITY. If any provision of this Agreement is held to be invalid, illegal, or unenforceable under any statute, regulation, ordinance, executive order, or other rule of law, that provision will be deemed severed to the extent necessary to comply with such statute, regulation, ordinance, order, or rule. In the event such provision is deemed severed, the parties will negotiate in good faith to arrive at an alternative arrangement approximating the original business objective of the parties. The remaining terms and conditions of this Agreement will remain in effect.

39. NO IMPLIED WAIVER. The failure of either party at any time to require performance by the other party of any provision of this Agreement will in no way affect the right to require such performance at any time thereafter, nor will the waiver of either party of a breach of any provision of this Agreement constitute a waiver of any succeeding breach of the same or any other provision.

40. MISCELLANEOUS. (a) This Agreement does not make either party the agent or legal representative of the other party. Neither party is authorized to create any obligation on behalf of the other party including, but not limited to, the obligation for payment of any service or warranty obligation hereunder; (b) The rights and remedies herein reserved to Company are cumulative and additional to any other rights and remedies provided at law or equity; (c) The official text of this Agreement is in the English language. If this Agreement is translated into another language, the English text will govern any question with respect to interpretation;

(d) The headings in this Agreement are for convenience of reference only and do not affect the meaning of this Agreement in any manner.

DEFINITIONS.

Capitalized terms have the meanings set forth in this Section, or in the Section in which they first appear in this Agreement.

"Agreement" means these Allegion Terms and Conditions of Sale and Service, together with any applicable Country Supplement or Region Supplement provided by Company, and all of the documents referenced herein or therein.

"Affiliate" means any Person that directly or indirectly, through one or more intermediaries, controls, is controlled by, or is under common control with, the Company. The term "control" (including the terms "controlled by" and "under common control with") means the possession, directly or indirectly, of the power to direct or cause the direction of the management and policies of a Person, whether through the ownership of voting securities, by contract or otherwise.

"Business Day" means any day except Saturday, Sunday or any other day on which commercial banks located in the United States are authorized or required by Law to be closed for business.

"Company" means Schlage Lock Company, LLC or any subsidiary or affiliate thereof selling products that are part of the Allegion product portfolio. Schlage Lock Company and/or its subsidiary or affiliates will be severally but not jointly liable under the Agreement.

"Company Marks" refers to the Marks of Company.

"Confidential Information" shall mean any and all information provided by either party to the other party pertaining to the disclosing party's business. Confidential Information shall include, but not be limited to, any bidding lists, formulae for products, manufacturing processes, production techniques, packaging processes, methods, research materials, ideas, marketing plans and related materials, quality standards, test results and data, apparatus, engineering drawings, contract documents, computer software, hardware, or firmware, business activities information such as financial information, reports, projections, books and records, customer and supplier information, and operations, customer and supplier lists and data, specifications, know how, and other Proprietary Information or Trade Secrets (as defined herein) that either party may furnish to the other party. Confidential Information shall not include information that: (a) is or becomes publicly known if such public knowledge or disclosure is not the result of any act or failure to act on the part of the receiving party; (b) is, at the time of disclosure, already known to the Receiving Party without utilizing the Confidential Information; (c) is information disclosed to the Receiving Party by a third party which is not to the Receiving Party's knowledge, after inquiry of the third party, under a duty of confidentiality to the Disclosing Party; or (d) is independently developed by the Receiving Party without the use of Confidential Information. The Receiving Party shall have the burden of proof as to prior knowledge and absence of breach. Confidential Information may be furnished in any tangible or intangible form including, but not limited to, writings, drawings, computer and other electronic media, logic diagrams, component specifications, graphs, prototypes, samples, or verbal communications and regardless of whether such information is marked or designated as "confidential." For the avoidance of doubt, all information, knowledge or data disclosed by Company to Customer, regardless of whether disclosed in written, tangible, oral, visual or other form, including, without limitation, sample products, equipment, software, or other objects or material, provided by Company to Customer, and all information, knowledge or data which was obtained by Customer from visits to Company's facilities, shall be considered "Confidential Information" under this Agreement.

"Content" means all information (including without limitation any text, music, sound, photographs, video, graphics, data or software), in any medium, on a particular Company Web page or Website or in Marketing Materials.

"Customer" means the purchaser of Deliverables from Company.

"Deliverables" means any good or service or both purchased by Customer from Company under these General Terms and Conditions of Sale and Service.

"End Users" means the purchaser that (a) has acquired a Deliverable from Customer for (i) its own and its Affiliate's/Affiliates' internal use and not for resale, remarketing or distribution or (ii) incorporation into its own products and (b) is an individual or entity, other than any federal, state or local agency, office or division.

"IP" means all intellectual property and industrial property rights comprising or relating to/ of the following: (a) Patents; (b) Trademarks; (c) internet domain names, whether or not Trademarks, registered by any authorized private registrar or Governmental Authority, web addresses, web pages, website and URLs; (d) works of authorship, expressions, designs and design registrations, whether or not copyrightable, including copyrights and copyrightable works, software and firmware, application programming interfaces, architecture, files, records, schematics, data, data files, and databases and other specifications and documentation; (e) Trade Secrets; and (f) all other intellectual property and industrial property rights, and all rights, interests and protections that are associated with, equivalent or similar to, or required for the exercise of, any of the foregoing, however arising, in each case whether registered or unregistered and including all registrations and applications for, and renewals or extensions of, such rights or forms of protection pursuant to the Laws of any jurisdiction throughout in any part of the world.

"Marketing Materials" means all marketing brochures, buckslips, pamphlets, emails, text, call scripts or other material, whether in printed format, audio or audiovisual format, or in any other format, that contain any (i) Content relating to the Company Deliverables or (ii) Company Marks.

"Marks" means collectively the domain names, trademarks, trade names, service marks, trade dress, logos, and the like used or provided by either party for use in connection with this Agreement.

"Patents" means all patents (including all reissues, divisionals, provisionals, continuations and continuations-in-part, re-examinations, renewals, substitutions and extensions thereof), patent applications, and other patent rights and any other Governmental Authority-issued indicia of invention ownership (including inventor's certificates, petty patents and patent utility models).

"Person" means a person or entity.

"Price Books" mean Company's current Price Book in effect for the applicable Deliverable being purchased by Customer.

"Trade Secrets" means and includes business or technical information of either party, including processes, formulas, devices, techniques, compilations and other material that a party attempts to maintain in secret and that derive commercial value for such party from not being generally known to the public or readily ascertainable through independent development or reverse engineering.

DOOR CLOSER SPECIALISTS

Since its founding in 1926, LCN has specialized in solving door control problems through the use of high quality, innovative door control products. By adhering to high standards of performance, LCN has earned a leadership role within the industry and is committed to meeting door control challenges of the future. With representatives located throughout the world, LCN provides the products and services necessary to solve your door control problems.

The LCN formula for success



Materials

LCN is committed to providing the best door closers in the world. In addition to the mechanical advantages derived from proven designs, much of the durability of the closer and arm system is related to the materials used in their manufacturing.



Extensive Abuse Test

Why do some hardware professionals claim that LCN stands for "Last Closer Needed?" LCN closers are put through grueling tests in which they exceed industry requirements.



Forged Steel Arms

The closing power and control generated within LCN closers is transferred to the door through forged steel arms. Forged steel arms have greater strength, better appearance and less bulk.

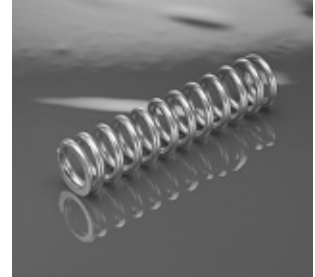

Chrome Silicon

Many closer manufacturers use less expensive oil-tempered springs, but LCN engineers know that such a spring loses up to 20% of its power after a few thousand cycles.



Heat-Treated

LCN steel pinions have larger, stronger teeth and are double heat-treated for the greatest possible strength on the shaft. Heat-treating makes the pinion harder, better able to resist wear after years of service and results in less stress on the cylinder.



Special Templates

When a standard door closer won't do the job, there is only one proven, reliable source for special solutions — LCN. With over 3,000 special templates on file, LCN can provide a door control solution for one-of-a-kind doors such as vault, balanced, over-sized and arch doors.



Hydraulic Fluid

LCN uses a special formula hydraulic fluid with special lubrication properties to keep closer components working smoothly. This unique all-weather hydraulic fluid eliminates the need for seasonal adjustments.



Customer Service

At a time when machines are picking up more and more customer calls, real people are answering the phones at LCN. Every member of our customer service staff is trained and qualified to assist you with orders, closer selection and special applications.

United State Minimum Advertised Pricing Policy (MAP) for LCN

Allegion through its Schlage Lock Company, LLC entity ("Allegion") has determined that certain advertising practices undermine Allegion's trade reputation, brands, and premium image within the target consumer population and discourage Allegion's Resellers (as hereinafter defined) from investing in the Allegion product lines and providing the best possible service and support to consumers. Accordingly, to protect the integrity of the Allegion brands, Allegion has adopted this unilateral Minimum Advertised Price Policy ("MAP Policy"), which applies to all distributors, wholesalers, retailers, and other resellers who are recognized as Authorized Sellers, Authorized Resellers or Authorized Retailers by Allegion (collectively, "Resellers") of Allegion products in the United States of America.

The MAP Policy applies to all products listed on the Allegion MAP Schedule ("Covered Products"). Allegion is solely responsible for establishing the minimum advertised price ("MAP") for each Covered Product and will communicate the MAP for each Covered Product to all Resellers through the Allegion MAP Schedule.

Commercial Product MAP Schedule

- The MAP for the "covered products" for LCN® 4000 and 1460 series offered by Allegion for resale in the United States of America shall be 43% off the list price identified in the most current price book issued by Allegion USA for use in the United States of America.

Manufacturer Suggested Retail Price:

- MSRP will provide guidance to sellers to accurately position our product pricing in the market which represents our brand, quality, and value the products bring to our end customer.
- MSRP will be 23% off list price for LCN 4000's series door closers and LCN 1460's series door closers.

COMPLETE DOOR CLOSERS

PRICE LIST

CLOSER SERIES		STANDARD POWDER COAT FINISHES	PLATED FINISHES			S H E E T P I N G	 May 2019
SERIES NUMBER	ARM TYPE	AL (689) DKBRZ (695) BRASS (696) LTBRZ (691) STAT (690) BLACK (693)	US26D	US 3 US 4 US 10	US 11 US 15 US 26		

1250 Series - Surface Mount

1250	Rw/PA*	\$205	N/A	N/A	8
1250	Rw/62A	220	N/A	N/A	7
1250	LONG	205	N/A	N/A	7
1250	Hw/PA*	235	N/A	N/A	10
1250	HLONG	235	N/A	N/A	10
1250	EDA	255	N/A	N/A	8
1250	HEDA (Handed)	290	N/A	N/A	8
1250	CUSH	290	N/A	N/A	9
1250	HCUSH	350	N/A	N/A	9
1250	SCUSH	350	N/A	N/A	9
1250	SHCUSH	410	N/A	N/A	9

Add for; Slim Cover (**SLIM**) (\$15), TORX Fasteners (**TORX**) (\$15), Special Rust Inhibitor (**SRI**) (\$40)

*Note - When BAA (Buy American Act) is required for 1250 Rw/PA and Hw/PA in AL or DKBRZ please designate BAA when ordering.

Buy American Act (BAA) (\$30) for 1250 Rw/PA and Hw/PA in AL or DKBRZ.

For parts & accessories, see page 50

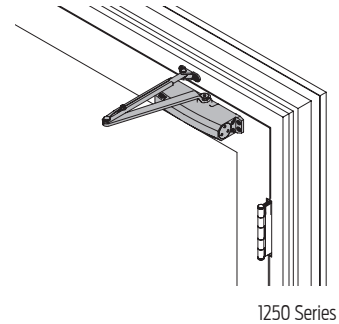

1260 Series - Surface Mount

1261	REG	\$274	N/A	N/A	11
1261	Rw/PA	280	N/A	N/A	12
1261	Rw/62A	296	N/A	N/A	12
1261	LONG	280	N/A	N/A	11
1261	H	307	N/A	N/A	11
1261	Hw/PA	313	N/A	N/A	12
1261	HLONG	313	N/A	N/A	11
1261	EDA	334	N/A	N/A	13
1261	EDA w/62G	340	N/A	N/A	13
1261	HEDA (Handed)	367	N/A	N/A	13
1261	HEDA w/62G (Handed)	373	N/A	N/A	13
1261	CUSH	367	N/A	N/A	12
1261	HCUSH	428	N/A	N/A	12

Add for; Slim Cover (**SLIM**) (\$16), TORX Fasteners (**TORX**) (\$15), Special Rust Inhibitor (**SRI**) (\$40)

For parts & accessories, see page 50.

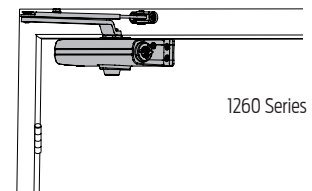

COMPLETE DOOR CLOSERS

PRICE LIST

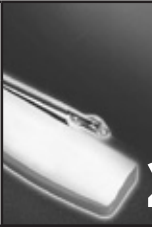
CLOSER SERIES		STANDARD POWDER COAT FINISHES	PLATED FINISHES			S H E I P H I G H T	 May 2019
SERIES NUMBER	ARM TYPE	AL (689) DKBRZ (695) BRASS (696) LTBRZ (691) STAT (690) BLACK (693)	US26D	US 3 US 4 US 10	US 11 US 15 US 26		

1450 Series - Surface Mount

1450	Rw/PA*	\$275	N/A	N/A	9
1450	Rw/62A	290	N/A	N/A	9
1450	LONG	275	N/A	N/A	8
1450	Hw/PA*	305	N/A	N/A	11
1450	HLONG	305	N/A	N/A	11
1450	EDA	325	N/A	N/A	9
1450	EDA w/62G	330	N/A	N/A	9
1450	HEDA	360	N/A	N/A	9
1450	CUSH	360	N/A	N/A	9
1450	HCUSH	420	N/A	N/A	10
1450	SCUSH	420	N/A	N/A	10
1450	SHCUSH	480	N/A	N/A	10

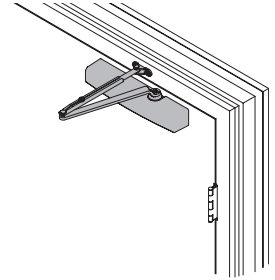

1450 Series

Add for; Delay Action (**DEL**) (\$40), Full Metal Cover (**MC**) (\$30), Full Plastic Cover (**FC**) (\$10), TORX Fasteners (**TORX**) (\$15), Custom Powder Finish (**RAL**) (\$40), Brite Metallic (**MTLPC**) (\$60), Special Rust Inhibitor (**SRI**) (\$40)

*Note - When BAA (Buy American Act) is required for 1450 Rw/PA and Hw/PA in AL or DKBRZ please designate BAA when ordering.
Buy American Act (**BAA**) (\$30) for 1450 Rw/PA and Hw/PA in AL or DKBRZ.

For parts & accessories, see page 50.

1450T Series - Surface Mount (Coming Soon)

1450T	STD	\$360	NA	NA	12
1450T	H	382	NA	NA	12
1450T	BUMPER	370	NA	NA	12
1450T	H BUMPER	390	NA	NA	12

Add for; Full Metal Cover (**MC**) (\$30), Full Plastic Cover (**FC**) (\$10), TORX Fasteners (**TORX**) (\$15), Special Rust Inhibitor (**SRI**) (\$40), Custom Powder Finish (**RAL**) (\$40), Brite Metallic (**MTLPC**) (\$60)

1460 Series - Surface Mount

1461	REG	\$350	\$630	\$704	9
1461	Rw/PA	356	687	777	11
1461	Rw/62A	372	705	792	11
1461	LONG	356	634	710	9
1461	H	383	661	743	10
1461	Hw/PA	389	724	799	11
1461	HLONG	389	649	733	10
1461	HD	383	661	743	9
1461	HD/PA	389	724	799	11
1461	HDw/62A	405	744	833	11
1461	HD/LONG	389	724	799	10
1461	EDA	410	771	849	12
1461	EDA w/62G	416	777	853	12
1461	HEDA (Handed)	443	804	885	12
1461	HEDA w/62G (Handed)	449	815	881	12
1461	CUSH	449	815	881	11
1461	HCUSH	504	853	951	11
1461	SCUSH	504	853	951	11
1461	SHCUSH	565	914	1002	11

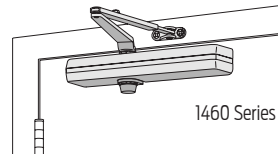

1460 Series

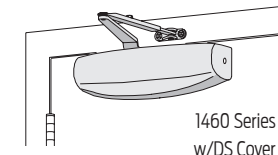

1460 Series
w/DS Cover

Add for; Delay Action (**DEL**) (\$45), Designer Series Cover (**DS**) (\$33), Full Cover (**FC**) (\$12), TORX Fasteners (**TORX**) (\$15), Special Rust Inhibitor (**SRI**) (\$40), Custom Powder Finish (**RAL**) (\$40), Brite Metallic (**MTLPC**) (\$60)

For parts & accessories, see page 51.

1460T Series - Surface Mount

1460T, 1461T	STD	439	712	788	12
1460T, 1461T	H	460	733	809	12
1460T, 1461T	BUMPER	449	722	798	12
1460T, 1461T	H BUMPER	472	745	821	12

Add for; Designer Series Cover (**DS**) (\$33), Full Cover (**FC**) (\$13), TORX Fasteners (**TORX**) (\$15), Special Rust Inhibitor (**SRI**) (\$40), Custom Powder Finish (**RAL**) (\$40), Brite Metallic (**MTLPC**) (\$60)

For parts & accessories, see page 51.

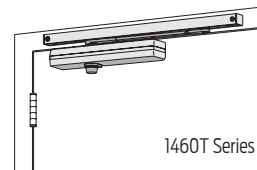

1460T Series

Indicates products that have EPD documentation available and meet LEED v4.

COMPLETE DOOR CLOSERS

PRICE LIST

CLOSER SERIES		STANDARD POWDER COAT FINISHES	PLATED FINISHES			S H E E T P I N G	 May 2019
SERIES NUMBER	ARM TYPE	AL (689) DKBRZ (695) BRASS (696) LTBRZ (691) STAT (690) BLACK (693)	US26D	US 3 US 4 US 10	US 11 US 15 US 26		

2010 Series - Concealed (Requires Handing)

2011, 2013-2016 STD	\$661	\$1,130	\$1,292	13
2011, 2013-2016 H	682	1151	1313	14
2011, 2013-2016 BUMPER	671	1140	1302	13
2011, 2013-2016 H BUMPER	694	1163	1325	14

Add for; TORX Fasteners (**TORX**) (\$15), Special Rust Inhibitor (**SRI**) (\$40), Custom Powder Finish (**RAL__**) (\$40), Brite Metallic (**MTLPC**)* (\$60)

For parts & accessories, see page 52.

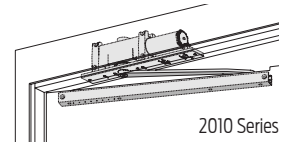

2030 Series - Concealed (Requires Handing)

2031-2035 STD	\$1,100	\$1,551	\$1,689	14
2031-2035 H	1121	1,572	1,710	14
2031-2035 BUMPER	1110	1,561	1,699	14
2031-2035 H BUMPER	1133	1,584	1,722	14

Add for; TORX Fasteners (**TORX**) (\$15), Special Rust Inhibitor (**SRI**) (\$40), Custom Powder Finish (**RAL__**) (\$40), Brite Metallic (**MTLPC**)* (\$60)

For parts & accessories, see page 52.

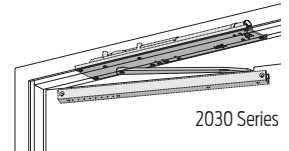

2210 Series - Concealed (Requires Handing)

2213-2215 STD	\$914	\$1,300	\$1,382	17
2213DPS-2215DPS STD	1,025	1,411	1,493	17

Add for; Advanced Variable Backcheck (**AVB**) (\$23), Special Rust Inhibitor (N/A with DPS) (**SRI**) (\$40), Custom Powder Finish (**RAL__**) (\$40), Brite Metallic (**MTLPC**) (\$60)

For parts & accessories, see page 52.

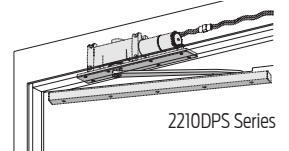

2310ME Series - Concealed (Requires Handing & Voltage)

2314ME STD	\$1,229	\$1,566	\$1,665	17
------------------	----------------	---------	---------	----

Add for; Bypass Cylinder (**B80**) or (**B140**) (\$88), TORX Fasteners (**TORX**) (\$15), Custom Powder Finish (**RAL__**)* (\$40), Brite Metallic (**MTLPC**)* (\$60)

For parts & accessories, see page 52.

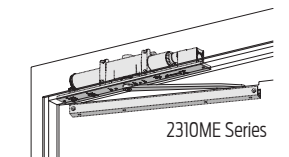

2610 Series - Concealed (Requires Handing)

2613-2614 STD	\$2,217	\$2,619	\$2,736	22
2613DPS-2614DPS STD	2,429	2831	2949	22

Add for; Custom Powder Finish (**RAL__**)* (\$40), Brite Metallic (**MTLPC**)* (\$60)

See pages 20-21 for control boxes and compressors. Also, see pages 26-43 for actuators, tubing, & accessories.

For parts & accessories, see page 53.

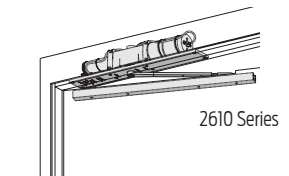

COMPLETE DOOR CLOSERS

PRICE LIST

CLOSER SERIES		STANDARD POWDER COAT FINISHES	PLATED FINISHES		S H E E P I N G	 May 2019
SERIES NUMBER	ARM TYPE	ANCLR ANDKB	N/A	N/A		



2810 Series - Concealed (Requires Handing)

2811.....STD/CP	\$4,729	ANCLR or ANDKB	78
2811.....STD/OP	4,746	ANCLR or ANDKB	78

Header lengths available 33" to 48" on operators without **POS** or **BKY** (please specify).
 Header lengths available 36" to 48" on operators with **POS** or **BKY** (please specify).
 STD/CP arm has 2 3/4" spindle center, STD/OP arm has 3 3/4" spindle center.
 Add for; Double Door Header (49" to 98" – please specify) (**DD**) (**\$242**),
 Positive Mechanical Stop (STD/CP arm only) (**POS**) (**\$26**), Breakaway Stop (STD/CP arm only) (**BKY**) (**\$95**)
 Manual Prep (requires DD header and STD/OP arm) (49" to 98" - please specify) (**MPDD**) (**\$658**)
 See pages 30-47 for actuators & accessories.
 For parts & accessories, see page 53.

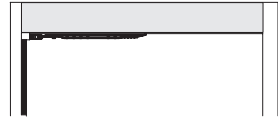

2810 Series



2850 Series - Concealed/Simultaneous Pair

2853.....STD/CP	\$7,636	ANCLR or ANDKB	155
2853.....STD/OP	7,664	ANCLR or ANDKB	155

Header lengths available 52" to 98" on operators without **POS** or **BKY** (please specify).
 Header lengths available 70" to 98" on operators with **POS** or **BKY** (please specify).
 STD/CP arm has 2 3/4" spindle center, STD/OP arm has 3 3/4" spindle center.
 Add for; Positive Mechanical Stop (STD/CP arm only) (**POS**) (**\$52**), Breakaway Stop (STD/CP arm only) (**BKY**) (**\$190**)
 See pages 30-47 for actuators & accessories.
 For parts & accessories, see page 53.

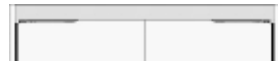

2850 Series



2860 Series - Concealed/Independent Pair

2863.....STD/CP	\$9,406	ANCLR or ANDKB	155
2863.....STD/OP	9,386	ANCLR or ANDKB	155

Header lengths available 65" to 98" on operators without **POS** or **BKY** (please specify).
 Header lengths available 70" to 98" on operators with **POS** or **BKY** (please specify).
 STD/CP arm has 2 3/4" spindle center, STD/OP arm has 3 3/4" spindle center.
 Add for; Positive Mechanical Stop (STD/CP arm only) (**POS**) (**\$52**), Breakaway Stop (STD/CP arm only) (**BKY**) (**\$190**)
 See pages 30-47 for actuators & accessories.
 For parts & accessories, see page 53.

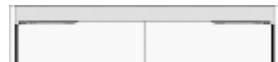

2860 Series



CLOSER SERIES		STANDARD POWDER COAT FINISHES	PLATED FINISHES			S H E E T P I N C H T
SERIES NUMBER	ARM TYPE	AL (689) DKBRZ (695) BRASS (696) LTBRZ (691) STAT (690) BLACK (693)	US26D	US 3 US 4 US 10	US 11 US 15 US 26	

3030 Series - Concealed (Requires Handing)

3031-3034..... REG	\$474	\$682	\$736	6
3031-3034..... H	506	714	768	6

Add for; TORX Fasteners (**TORX**) (\$15), Special Rust Inhibitor (**SRI**) (\$40), Custom Powder Finish (**RAL**___)* (\$40), Brite Metallic (**MTLPC**)* (\$60)
For parts & accessories, see page 54.

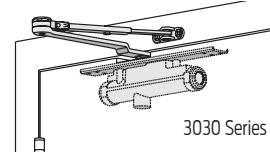

3130 Series - Concealed (Requires Handing)

3131-3133..... STD	\$555	\$755	\$813	8
3131-3133..... H	576	776	834	8
3131-3133..... BUMPER	565	765	823	8
3131-3133..... H BUMPER	588	788	846	8

Add for; TORX Fasteners (**TORX**) (\$15), Special Rust Inhibitor (**SRI**) (\$40), Custom Powder Finish (**RAL**___)* (\$40), Brite Metallic (**MTLPC**)* (\$60)
For parts & accessories, see page 54.

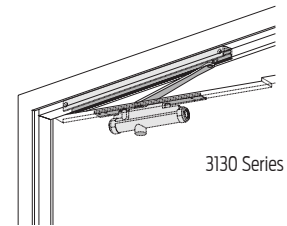

3130SE Series - Concealed (Requires Handing & Voltage)

3133SE-3134SE STD	\$874	\$1,074	\$1,132	8
3133SE-3134SE LONG	879	1,101	1,159	8

Add for; TORX Fasteners (**TORX**) (\$15), Custom Powder Finish (**RAL**___)* (\$40), Brite Metallic (**MTLPC**)* (\$60)
For parts & accessories, see page 54.

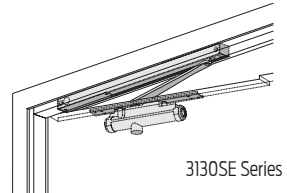

4000T Series - Wall Pocket (SEM7800 Series Available Separately)

4003T-4004T STD	\$552	\$873	\$977	15
-----------------------	--------------	-------	-------	----

Add for; Metal Cover (**MC**) (\$10), TORX Fasteners (**TORX**) (\$15), Special Rust Inhibitor (**SRI**) (\$40), Custom Powder Finish (**RAL**___)* (\$40), Brite Metallic (**MTLPC**)* (\$60)
For parts & accessories, see page 54.

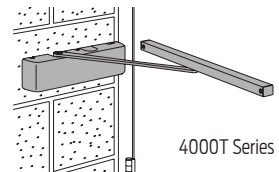

4010 Series - Surface Mount (Requires Handing)

4011 or 4016 REG	\$490	\$924	\$1,067	11
4011 or 4016 H	517	951	1,094	12
4011 or 4016 FL	625	NA	NA	15

Add for; Delay Action (**DEL**) (\$43) (4011 only), Telephone Cylinder (**TEL**) (\$43), Metal Cover (**MC**) (\$10), TORX Fasteners (**TORX**) (\$15), Special Rust Inhibitor (**SRI**) (\$40), Custom Powder Finish (**RAL**___)* (\$40), Brite Metallic (**MTLPC**)* (\$60)

Note - 4010 Series is available as 4011 (Adjustable 1-5) or 4016 (Size 6 Only - Not ADA Compliant).
For parts & accessories, see page 54.

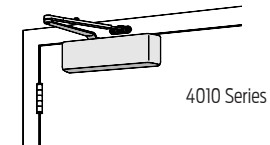

4010T Series - Surface Mount (Requires Handing)

4011T, 4013T-4014T STD	\$546	\$856	\$948	16
4011T, 4013T-4014T H	567	877	969	16
4011T, 4013T-4014T BUMPER	556	866	958	16
4011T, 4013T-4014T H BUMPER	579	889	981	16
4011T, 4013T-4014T DE	592	902	994	16
4011T, 4013T-4014T DE HO	613	923	1015	16
4011T, 4013T-4014T DE BUMPER	602	912	1004	16
4011T, 4013T-4014T DE H BUMPER	625	935	1027	16

Add for; Metal Cover (**MC**) (\$10), TORX Fasteners (**TORX**) (\$15), Special Rust Inhibitor (**SRI**) (\$40), Custom Powder Finish (**RAL**___)* (\$40), Brite Metallic (**MTLPC**)* (\$60)

For parts & accessories, see page 55.

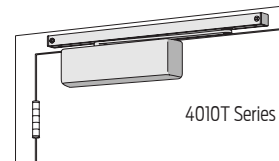

Indicates products that have EPD documentation available and meet LEED v4.

COMPLETE DOOR CLOSERS

PRICE LIST

CLOSER SERIES		STANDARD POWDER COAT FINISHES	PLATED FINISHES			S H E E T P I N G	 <div style="font-size: 2em; font-weight: bold; margin-top: 5px;">May 2019</div>
SERIES NUMBER	ARM TYPE	AL (689) DKBRZ (695) BRASS (696) LTBRZ (691) STAT (690) BLACK (693)	US26D	US 3 US 4 US 10	US 11 US 15 US 26		



4020 Series - Surface Mount (Requires Handing)

4021 or 4026..... REG	\$490	\$913	\$1,064	11
4021 or 4026..... LONG	491	912	1,058	11
4021 or 4026..... H	503	910	1,050	12
4021 or 4026..... FL	617	NA	NA	12

Add for; Delay Action (**DEL**) (\$43) (4021 only), Telephone Cylinder (**TEL**) (\$43), Metal Cover (**MC**) (\$10), TORX Fasteners (**TORX**) (\$15), Special Rust Inhibitor (**SRI**) (\$40), Custom Powder Finish (**RAL**___)* (\$40), Brite Metallic (**MTLPC**)* (\$60)

Note - 4020 Series is available as 4021 (Adjustable 1-5) or 4026 (Size 6 Only - Not ADA Compliant).
For parts & accessories, see page 55.

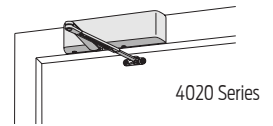

4020T Series - Surface Mount (Requires Handing)

4021T, 4023T-4024T STD	\$546	\$856	\$948	15
4021T, 4023T-4024T H	567	877	969	16
4021T, 4023T-4024T BUMPER	556	866	958	15
4021T, 4023T-4024T H BUMPER	579	889	981	16

Add for; Metal Cover (**MC**) (\$10), TORX Fasteners (**TORX**) (\$15), Special Rust Inhibitor (**SRI**) (\$40), Custom Powder Finish (**RAL**___)* (\$40), Brite Metallic (**MTLPC**)* (\$60)

For parts & accessories, see page 55.

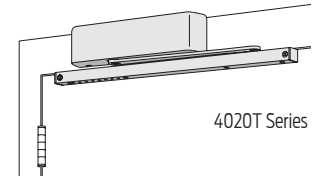

4030 Series - Surface Mount

4031..... REG	\$419	\$742	\$853	8
4031.....Rw/PA	424	802	931	9
4031.....Rw/62A	441	820	948	8
4031.....LD	396	700	793	8
4031.....LD/PA	402	760	871	8
4031.....LD/62A	418	779	890	8
4031.....LONG	424	747	860	8
4031.....H	452	766	876	8
4031.....Hw/PA	457	825	947	9
4031.....HLONG	457	771	881	8
4031.....EDA	457	771	881	9
4031.....HEDA (Handed)	490	884	981	9
4031.....CUSH	490	884	981	9
4031.....HCUSH	550	966	1,039	9
4031.....SCUSH	550	966	1,039	9
4031.....SHCUSH	611	1024	1,096	9

Add for; Special Rust Inhibitor (**SRI**) (\$40), Custom Powder Finish (**RAL**___)* (\$40), Brite Metallic (**MTLPC**)* (\$60)

For parts & accessories, see page 56.

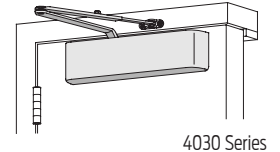

4030T Series - Surface Mount

4031T..... STD	\$489	\$794	\$882	9
4031T..... H	510	815	903	9

Add for; Special Rust Inhibitor (**SRI**) (\$40), Custom Powder Finish (**RAL**___)* (\$40), Brite Metallic (**MTLPC**)* (\$60)

For parts & accessories, see page 56.

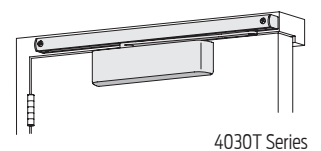

Indicates products that have EPD documentation available and meet LEED v4.

COMPLETE DOOR CLOSERS

PRICE LIST

CLOSER SERIES		STANDARD POWDER COAT FINISHES	PLATED FINISHES			S H E E T P I N G S	 May 2019
SERIES NUMBER	ARM TYPE	AL (689) DKBRZ (695) BRASS (696) LTBRZ (691) STAT (690) BLACK (693)	US26D	US 3 US 4 US 10	US 11 US 15 US 26		



4040XP Series - Surface Mount

4040XP.....REG	\$507	\$956	\$1,109	13
4040XP.....Rw/PA	512	1,016	1,182	13
4040XP.....LONG	512	962	1,116	14
4040XP.....XLONG	545	995	1,143	14
4040XP.....Rw/62A	535	1,035	1,202	12
4040XP.....H	568	1000	1,156	13
4040XP.....Hw/PA	573	1,069	1,245	12
4040XP.....HLONG	573	1007	1,160	12
4040XP.....EDA	556	990	1,144	14
4040XP.....EDA w/62G	561	995	1,149	13
4040XP.....HEDA (Handed)	589	1023	1,171	14
4040XP.....HEDA w/62G (Handed)	594	1,028	1,176	13
4040XP.....CUSH	589	1,028	1,177	14
4040XP.....HCUSH	644	1,088	1,237	14
4040XP.....SCUSH	644	1,088	1,237	15
4040XP.....SHCUSH	698	1,142	1,291	15

Add for; Delay Action (**DEL**) (**\$43**) (Standard 4041 Cylinder - Not XP), Metal Cover (Handed) (**MC**) (**\$10**), TORX Fasteners (**TORX**) (**\$15**), Special Rust Inhibitor (**SRI**) (**\$40**), Custom Powder Finish (RAL___)* (**\$40**), Brite Metallic (**MTLPC**)* (**\$60**)
 For parts & accessories, see page 56.

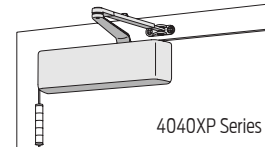

4040XPT Series - Surface Mount

4040XPT.....STD	\$566	\$870	\$960	15
4040XPT.....H	587	891	981	16
4040XPT.....BUMPER	576	880	970	15
4040XPT.....H BUMPER	599	903	993	16
4040XPT.....DE (Handed)	610	921	1,009	16
4040XPT.....DE H (Handed)	631	942	1,030	16
4040XPT.....DE BUMPER (Handed)	620	931	1,019	16
4040XPT.....DE H BUMPER (Handed)	643	954	1,042	16

Add for; Metal Cover (Handed) (**MC**) (**\$10**), TORX Fasteners (**TORX**) (**\$15**), Special Rust Inhibitor (**SRI**) (**\$40**), Custom Powder Finish (RAL___)* (**\$40**), Brite Metallic (**MTLPC**)* (**\$60**)
 For parts & accessories, see page 57.

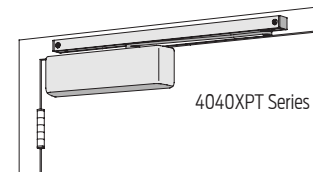

4040SE Series - Surface Mount (Requires Voltage)

4040SE.....STD	\$899	\$1,219	\$1,324	12
4040SE.....LONG	899	1,219	1,324	12
4040SE.....DE (Handed)	947	1,266	1,371	12

Add for; Metal Cover (Handed) (**MC**) (**\$10**), TORX Fasteners (**TORX**) (**\$15**), Custom Powder Finish (RAL___)* (**\$40**), Brite Metallic (**MTLPC**)* (**\$60**)
 For parts & accessories, see page 57.

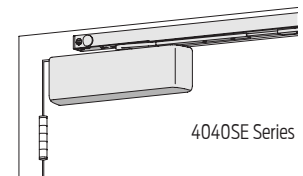

4040SEH Series - Surface Mount Arm & Track Only (Requires Voltage) (Closer Available Separately)

4040SEH.....4040SEH-3038 w/Arm	\$568	\$752	\$792	8
--------------------------------	--------------	-------	-------	---

Add for; TORX Fasteners (**TORX**) (**\$15**)
 Note - Includes 4040SEH Track & 4040SEH Arm Only.
 For parts & accessories, see page 57.

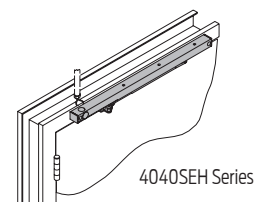

Indicates products that have EPD documentation available and meet LEED v4.

COMPLETE DOOR CLOSERS

PRICE LIST

CLOSER SERIES		STANDARD POWDER COAT FINISHES	PLATED FINISHES			S H E E T P I N G S	 May 2019
SERIES NUMBER	ARM TYPE	AL (689) DKBRZ (695) BRASS (696) LTBRZ (691) STAT (690) BLACK (693)	US26D	US 3 US 4 US 10	US 11 US 15 US 26		

4050 Series - Surface Mount

4050.....Rw/PA	\$448	N/A	N/A	13
4050.....LONG	448	N/A	N/A	14
4050.....Rw/62A	468	N/A	N/A	13
4050.....Hw/PA	489	N/A	N/A	12
4050.....HLONG	489	N/A	N/A	12
4050.....EDA	479	N/A	N/A	14
4050.....EDA w/62G	484	N/A	N/A	13
4050.....HEDA (handed)	510	N/A	N/A	14
4050.....HEDA w/62G (handed)	515	N/A	N/A	13
4050.....CUSH	510	N/A	N/A	14
4050.....HCUSH	571	N/A	N/A	14
4050.....SCUSH	571	N/A	N/A	15
4050.....SHCUSH	633	N/A	N/A	15

Add for; Delay Action (**DEL**) (\$43), Metal Cover (**MC**) (\$10), TORX Fasteners (**TORX**) (\$15), Custom Powder Finish (**RAL**___) (\$40), Brite Metallic (**MTLPC**) (\$60), Special Rust Inhibitor (**SRI**) (\$40).
For parts & accessories, see page 57.

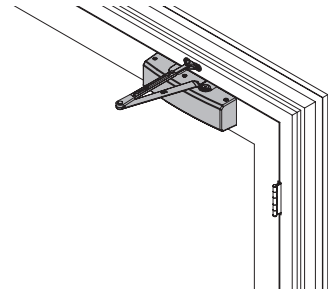

4050 Series

4050T Series - Surface Mount

4050T.....STD	505	N/A	N/A	15
4050T.....H	531	N/A	N/A	16
4050T.....BUMPER	515	N/A	N/A	15
4050T.....H BUMPER	541	N/A	N/A	16
4050T.....DE (Handed)	551	N/A	N/A	16
4050T.....DE H (Handed)	577	N/A	N/A	16
4050T.....DE BUMPER (Handed)	561	N/A	N/A	16
4050T.....DE H BUMPER (Handed)	587	N/A	N/A	16

Add for; Metal Cover (**MC**) (\$10), TORX Fasteners (**TORX**) (\$15), Special Rust Inhibitor (**SRI**) (\$40), Custom Powder Finish (**RAL**___) (\$40), Brite Metallic (**MTLPC**) (\$60).
For parts & accessories, see page 58.

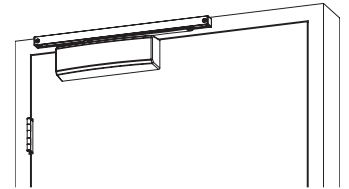

4050T Series

4110 Series - Surface Mount (Requires Handing)

4111 or 4116.....EDA	\$490	\$919	\$1,069	13
4111 or 4116.....EDA w/62G	495	924	1,074	13
4111 or 4116.....HEDA	523	948	1,074	13
4111 or 4116.....HEDA w/62G	523	948	1,100	13
4111 or 4116.....FL	630	NA	NA	15
4111 or 4116.....CUSH	523	948	1,100	13
4111.....HCUSH	582	1005	1,163	14
4111 or 4116.....SCUSH	582	1005	1,163	15
4111.....SHCUSH	637	1,060	1,208	15

Add for; Delay Action (**DEL**) (\$43) (4111 only), Advanced Variable Backcheck (**AVB**) (\$21), Telephone Cylinder (**TEL**) (\$43), Metal Cover (**MC**) (\$10), TORX Fasteners (**TORX**) (\$15), Special Rust Inhibitor (**SRI**) (\$40), Custom Powder Finish (**RAL**___)* (\$40), Brite Metallic (**MTLPC**)* (\$60)
Note - 4110 Series is available as 4111 (Adjustable 1-5) or 4116 (Size 6 Only - Not ADA Compliant).
For parts & accessories, see page 58.

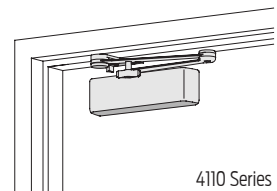

4110 Series

4110T Series - Surface Mount (Requires Handing)

4111T, 4113T-4114T.....STD	\$545	\$854	\$948	15
4111T, 4113T-4114T.....H	566	875	969	16
4111T, 4113T-4114T.....BUMPER	555	864	958	15
4111T, 4113T-4114T.....H BUMPER	578	887	981	16

Add for; Metal Cover (**MC**) (\$10), TORX Fasteners (**TORX**) (\$15), Special Rust Inhibitor (**SRI**) (\$40), Custom Powder Finish (**RAL**___)* (\$40), Brite Metallic (**MTLPC**)* (\$60)
For parts & accessories, see page 58.

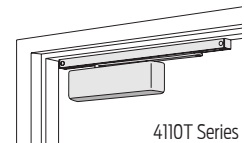

4110T Series

COMPLETE DOOR CLOSERS

PRICE LIST

CLOSER SERIES		STANDARD POWDER COAT FINISHES	PLATED FINISHES			S H E E T P I P H T G	 May 2019
SERIES NUMBER	ARM TYPE	AL (689) DKBRZ (695) BRASS (696) LTBRZ (691) STAT (690) BLACK (693)	US26D	US 3 US 4 US 10	US 11 US 15 US 26		



4210 Series - Surface Mount (Requires Handing)

4211 or 4216EDA	\$541	\$899	\$1,113	14
4211 or 4216CUSH	574	959	1,141	14
4211.....HCUSH	633	1,046	1,194	15

Add for; Delay Action (**DEL**) (**\$43**) (4211 only), Advanced Variable Backcheck (**AVB**) (**\$21**), Special Rust Inhibitor (**SRI**) (**\$40**), Custom Powder Finish (**RAL__**)* (**\$40**), Brite Metallic (**MTLPC**)* (**\$60**)
 Note - 4210 Series is available as 4211 (Adjustable 1-5) or 4216 (Size 6 Only - Not ADA Compliant).
 For parts & accessories, see page 59.

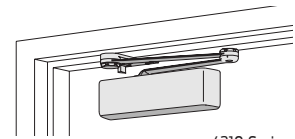

4210 Series



4210T Series - Surface Mount (Requires Handing)

4211T, 4213T-4214T.....STD	\$662	\$974	\$1,064	15
----------------------------	--------------	-------	---------	----

Add for; Advanced Variable Backcheck (**AVB**) (**\$23**), Special Rust Inhibitor (**SRI**) (**\$40**), Custom Powder Finish (**RAL__**)* (**\$40**), Brite Metallic (**MTLPC**)* (**\$60**)
 For parts & accessories, see page 59.

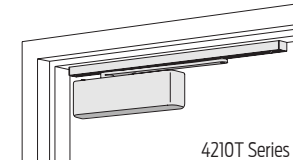

4210T Series



4310HSA Series - Surface Mount (Requires Handing & Voltage)

4311HSA.....STD	\$1,313	\$1,674	\$1,777	22
4311HSA.....DE	1,359	1,720	1,823	22

Add for; Custom Powder Finish (**RAL__**)* (**\$40**), Brite Metallic (**MTLPC**)* (**\$60**)
 For parts & accessories, see page 59.



4310HSA Series



4310ME Series - Surface Mount (Requires Handing & Voltage)

4314MESF	\$1,257	\$1,629	\$1,731	17
4314MEDE	1,302	1,674	1,776	17

Add for; Bypass Cylinder (**B80**) or (**B140**) (**\$88**), TORX Fasteners (**TORX**) (**\$15**), Custom Powder Finish (**RAL__**)* (**\$40**), Brite Metallic (**MTLPC**)* (**\$60**)
 For parts & accessories, see page 59.

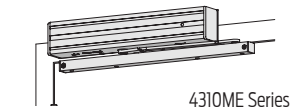

4310ME Series

 Indicates products that have EPD documentation available and meet LEED v4.

COMPLETE DOOR CLOSERS

PRICE LIST



CLOSER SERIES		STANDARD POWDER COAT FINISHES	PLATED FINISHES			S H E E T P I N G
SERIES NUMBER	ARM TYPE	AL (689) DKBRZ (695) BRASS (696) LTBRZ (691) STAT (690) BLACK (693)	US26D	US 3 US 4 US 10	US 11 US 15 US 26	



4410HSA Series - Surface Mount (Requires Handing & Voltage)

4412HSA.....	REG	\$1,253	\$1,733	\$18,391	22
4412HSA.....	LONG	1,287	1,765	1,922	22

Add for; Custom Powder Finish (**RAL**___)* (**\$40**), Brite Metallic (**MTLPC**)* (**\$60**)
 Closer price includes 4410HSA-18 for regular mount or 4410HSA-18G (please specify) plate for flush mount application.)
 For parts & accessories, see page 60.

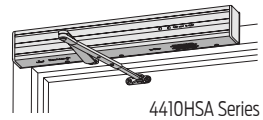

4410ME Series - Surface Mount (Requires Handing & Voltage)

4414ME.....	REG	\$1,166	\$1,646	\$1,803	17
4414ME.....	LONG	1200	1,678	1,835	17

Add for; Bypass Cylinder (**B80**) or (**B140**) (**\$87**), TORX Fasteners (**TORX**) (**\$15**), Custom Powder Finish (**RAL**___)* (**\$40**), Brite Metallic (**MTLPC**)* (**\$60**)
 Closer price includes 4410ME-18 for regular mount or 4410ME-18G (please specify) plate for flush mount application.
 For parts & accessories, see page 60.

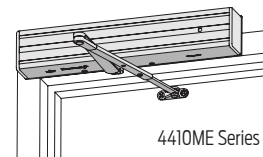

4510 Series - Surface Mount (Requires Handing)

4511 or 4516.....	EDA	\$553	\$956	\$1,100	14
-------------------	-----	--------------	-------	---------	----

Add for; Delay Action (**\$43**) (4511 only), Advanced Variable Backcheck (**AVB**) (**\$23**), Special Rust Inhibitor (**SRI**) (**\$40**), Custom Powder Finish (**RAL**___)* (**\$40**), Brite Metallic (**MTLPC**)* (**\$60**)
 Note - 4510 Series is available as 4511 (Adjustable 1-5) or 4516 (Size 6 Only - Not ADA Compliant)
 For parts & accessories, see page 60.

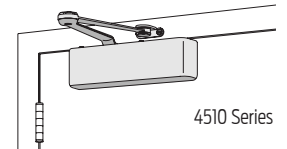

4510T Series - Surface Mount (Requires Handing)

4511T, 4513T-4514T.....	STD	\$642	\$940	\$1,028	15
-------------------------	-----	--------------	-------	---------	----

Add for; Advanced Variable Backcheck (**AVB**) (**\$23**), Special Rust Inhibitor (**SRI**) (**\$40**), Custom Powder Finish (**RAL**___)* (**\$40**), Brite Metallic (**MTLPC**)* (**\$60**)
 For parts & accessories, see page 60.

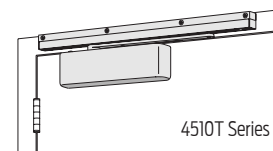

4630 Series - Surface Mount

4631.....	STD	\$5,682	\$6,060	\$6,174	40
-----------	-----	----------------	---------	---------	----

Add for; TORX Fasteners (**TORX**) (**\$15**), Custom Powder Finish (**RAL**___)* (**\$40**), Brite Metallic (**MTLPC**)* (**\$60**)
 Note - Optional Concealed On/Off Switch (**CS**) Available (**\$0**) - Please Specify.
 See pages 30-47 for actuators & accessories.
 For parts & accessories, see page 60.

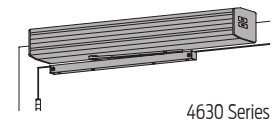

4640 Series - Surface Mount

4642.....	REG	\$5,585	\$6,090	\$6,246	40
4642.....	LONG	5,585	\$6,090	\$6,246	40

Add for; TORX Fasteners (**TORX**) (**\$15**), Custom Powder Finish (**RAL**___)* (**\$40**), Brite Metallic (**MTLPC**)* (**\$60**)
 Note - Optional Concealed On/Off Switch (**CS**) Available (**\$0**) - Please Specify.
 See pages 30-47 for actuators & accessories.
 For parts & accessories, see page 61.

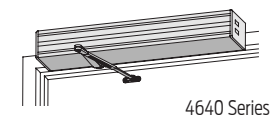

Indicates products that have EPD documentation available and meet LEED v4.

COMPLETE DOOR CLOSERS

PRICE LIST

CLOSER SERIES		STANDARD POWDER COAT FINISHES	PLATED FINISHES			S H E E P I N G	
SERIES NUMBER	ARM TYPE	AL (689) DKBRZ (695) BRASS (696) LTBRZ (691) STAT (690) BLACK (693)	US26D	US 3 US 4 US 10	US 11 US 15 US 26		



4810 Series - Surface Mount

4811STD	\$2,164	\$2,505	\$2,620	19
------	----------	----------------	---------	---------	----

Add for; Custom Powder Finish (RAL___)* (\$40), Brite Metallic (MTLPC)* (\$60)
For parts & accessories, see page 61.

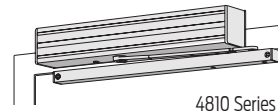

4820 Series - Surface Mount

4822REG	\$2,062	\$2,539	\$2,697	19
4822LONG	2,084	2,566	2,722	19

Add for; Custom Powder Finish (RAL___)* (\$40), Brite Metallic (MTLPC)* (\$60)
Closer price includes 4820-18 plate for regular mount or 4820-18G (please specify) plate for flush mount application.
For parts & accessories, see page 61.

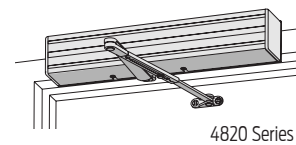

4840 Series - Surface Mount

4841EDA	\$2,106	\$2,568	\$2,729	20
4841CUSH	2,139	2,598	2,757	20
4841SCUSH	2,194	2,655	2,813	20

Add for; Custom Powder Finish (RAL___)* (\$40), Brite Metallic (MTLPC)* (\$60)
See pages 24-25 for control boxes and compressors. Also, see pages 30-47 for actuators, tubing, & accessories.
For parts & accessories, see page 61.

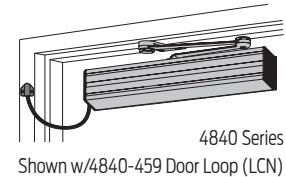

5010 Series - Concealed (Requires Handing)

5011-5016REG	\$611	\$1,012	\$1,165	12
5011-5016H	644	1,044	1,197	13

Add for; Delay Action (DEL) (\$43), TORX Fasteners (TORX) (\$15), Special Rust Inhibitor (SRI) (\$40), Custom Powder Finish (RAL___)* (\$40), Brite Metallic (MTLPC)* (\$60)
For parts & accessories, see page 61.

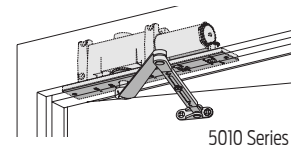

5030 Series - Concealed (Requires Handing)

5031, 5033-5036REG	\$1,026	\$1,540	\$1,726	14
5031, 5033-5036H	1,059	1,572	1,758	14

Add for; TORX Fasteners (TORX) (\$15), Special Rust Inhibitor (SRI) (\$40), Custom Powder Finish (RAL___)* (\$40), Brite Metallic (MTLPC)* (\$60)
For parts & accessories, see page 62.

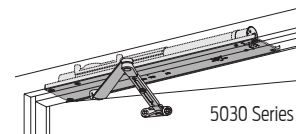

6030 Series - Concealed/Double Acting

6031-6035BUMPER	\$1,321	1721	1967	17
6031-6035H BUMPER	1,344	1,744	1,990	17

Add for; TORX Fasteners (TORX) (\$15), Special Rust Inhibitor (SRI) (\$40), Custom Powder Finish (RAL___)* (\$40), Brite Metallic (MTLPC)* (\$60)
For parts & accessories, see page 62.

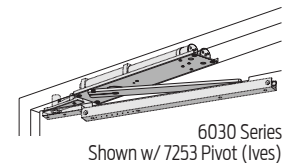

COMPLETE DOOR CLOSERS

PRICE LIST

CLOSER SERIES		STANDARD POWDER COAT FINISHES	PLATED FINISHES		S H E E T P R I N T	 May 2019
SERIES NUMBER	ARM TYPE	ANCLR ANDKB	N/A	N/A		



9130 Series - Surface Mount

9131.....STD (Pull) **\$3,805**

27" cover (MC) is standard - Optional 'Full Cover' (FC) (36") available (please specify)

Add for Full Cover (FC) (**\$100**)
See pages 30-47 for actuators & accessories.
For parts & accessories, see page 62.

Plated finish not available
ANCLR or ANDKB

38

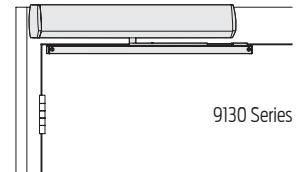

9130 Series



9140 Series - Surface Mount

9142.....REG (Push) **\$3,708**
9142.....LONG (Push) **3,713**

27" cover (MC) is standard - Optional 'Full Cover' (FC) (36") available (please specify)

Add for Full Cover (FC) (**\$103**)
See pages 30-47 for actuators & accessories.
For parts & accessories, see page 62.

Plated finish not available
ANCLR or ANDKB
ANCLR or ANDKB

38

38

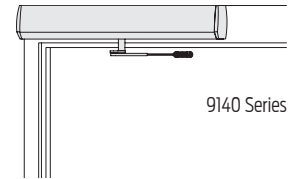

9140 Series



9150 Series - Surface Mount

9153.....REG2 (Push) **\$7,356**
9153.....LONG2 (Push) **7,366**

72" cover (MC) is standard. Additional lengths are not available.

See pages 30-47 for actuators & accessories.
For parts & accessories, see page 62.

Plated finish not available
ANCLR or ANDKB
ANCLR or ANDKB

85

85

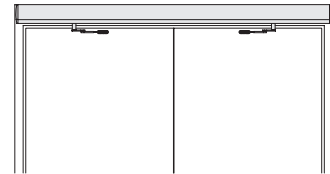

9150 Series

COMPLETE DOOR CLOSERS

PRICE LIST

CLOSER SERIES		STANDARD POWDER COAT FINISHES	PLATED FINISHES		S H E E T P I N T	
SERIES NUMBER	ARM TYPE	ANCLR ANDKB	N/A	N/A		



9530 Series - Surface Mount (Requires Handing)

9531.....STD (Pull) **\$4,854**

Header lengths available 33" to 48" (please specify).

Angle Brackets (**HL/B**) are standard, End Dress Plates (**HL/D**) are optional (please specify).

STD arm has 2 3/4" spindle center.

Add for; Double Door Header (49" to 98" – please specify) (**DD**) (**\$242**)

See pages 30-47 for actuators & accessories.

For parts & accessories, see page 62.

Plated finish not available
ANCLR or ANDKB

78

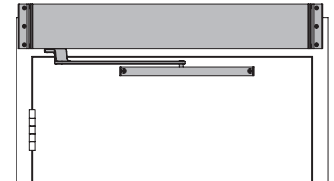

9530 Series



9540 Series - Surface Mount (Requires Handing)

9542REG (Push) **\$4,729**

9542LONG (Long Push) **4,735**

Header lengths available 33" to 48" (please specify).

Angle Brackets (**HL/B**) are standard, End Dress Plates (**HL/D**) are optional (please specify).

REG or LONG arm has 2 3/4" spindle center.

Optional 12 1/4" spindle available (requires minimum 43" header).

Add for; Double Door Header (49" to 98" – please specify) (**DD**) (**\$242**)

See pages 30-47 for actuators & accessories.

For parts & accessories, see page 63.

Plated finish not available

ANCLR or ANDKB

ANCLR or ANDKB

78

78

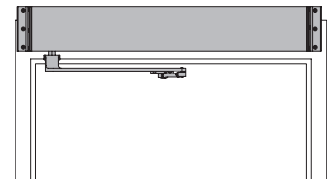

9540 Series



9550 Series - Surface Mount (DE Requires Handing) Plated finish not available

9553.....REG2 (Push Pair) **\$8,017**

9553.....LONG2 (Long Push Pair) **8,028**

9553.....STD2 (Pull Pair) **8,201**

9553.....REG/STD (Double Egress) **8,133**

Header lengths available 52" to 98" (please specify) on operators with REG or LONG (push) arms.

Header lengths available 60" to 98" (please specify) on operators with STD (pull) arms.

Header lengths available 60" to 98" (please specify) on operators with REG/STD (double egress) arms.

Angle Brackets (**HL/B**) are standard, End Dress Plates (**HL/D**) are optional (please specify).

REG, LONG, STD or REG/STD has 2 3/4" spindle center.

Optional 12 1/4" spindle available (requires minimum 71" header).

See pages 30-47 for actuators & accessories.

For parts & accessories, see page 63.

ANCLR or ANDKB

ANCLR or ANDKB

ANCLR or ANDKB

ANCLR or ANDKB

155

155

155

155

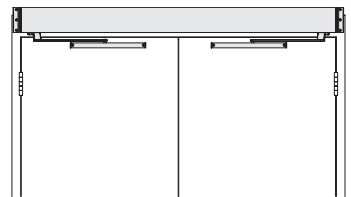

9550 Series



9560 Series - Surface Mount (DE Requires Handing) Plated finish not available

9563REG2 (Push Pair) **\$9,513**

9563LONG2 (Long Push Pair) **9,524**

9563STD2 (Pull Pair) **9,697**

9563REG/STD (Double Egress) **9,629**

Header lengths available 65" to 98" (please specify) on operators with REG or LONG (push) arms.

Header lengths available 65" to 98" (please specify) on operators with STD (pull) arms.

Header lengths available 65" to 98" (please specify) on operators with REG/STD (double egress) arms.

Angle Brackets (**HL/B**) are standard, End Dress Plates (**HL/D**) are optional (please specify).

REG, LONG, STD or REG/STD has 2 3/4" spindle center.

Optional 12 1/4" spindle available (requires minimum 84" header).

See pages 30-47 for actuators & accessories.

For parts & accessories, see page 63.

ANCLR or ANDKB

ANCLR or ANDKB

ANCLR or ANDKB

ANCLR or ANDKB

155

155

155

155

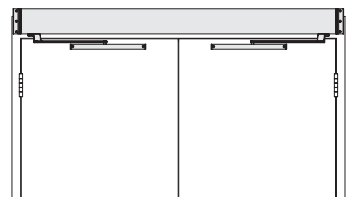

9560 Series

SEM SERIES MAGNETS PRICE LIST

SPECIALTY PRODUCTS	STANDARD POWDER COAT FINISHES	S H I P P I N G	
PRODUCT NUMBER	DESCRIPTION	AL (689) DKBRZ (695)	 <div style="font-size: 2em; font-weight: bold; margin-top: 10px;">May 2019</div>

SEM7800 Series Magnet Extension Kits

SEM7810-517..... SEM Extension Kit (55 pcs) **\$1,015** 8

Note - Extension Kit includes 1/2" extensions (10), 3/4" extensions (10), 1" extensions (10), 2" extensions (5) & ball pivot/connector links (20 ea). Individual extensions & ball pivot/connector links are available, please see page 50 in this price book for part number and list price.

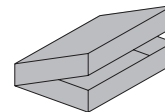

SEM7810



SEM7800 Series Magnets

SEM7820..... Floor Mount Magnet (Single Side) **\$693** 5

Low Profile Armature, Metal Housing,
Tri Voltage (12v/24v/120v) w/ 35lbs. holding force.

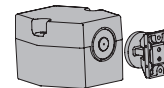

SEM7820

SEM7830..... Wall Mount Magnet **392** 4

Low Profile Armature, Metal Housing,
Tri Voltage (12v/24v/120v) w/ 35lbs. holding force.

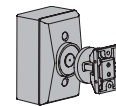

SEM7830

SEM7840..... Recessed Wall Mount Magnet **392** 4

Low Profile Armature, Metal Housing,
Tri Voltage (12v/24v/120v) w/ 35lbs. holding force.

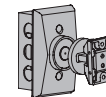

SEM7840

SEM7850..... Recessed Wall Mount Magnet **392** 4

Standard Profile Armature, Metal Housing,
Tri Voltage (12v/24v/120v) w/ 35lbs. holding force.
For parts & accessories, see page 50.

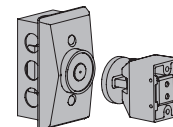

SEM7850

PAH60, PAINT AND FASTENERS

PRICE LIST

SPECIALTY PRODUCTS		STANDARD POWDER COAT FINISHES	PLATED FINISHES			S H E E T P I N G	
PRODUCT NUMBER	DESCRIPTION	AL (689) DKBRZ (695) BRASS (696) LTBRZ (691) STAT (690) BLACK (693)	US26D	US 3 US 4 US 10	US 11 US 15 US 26		

Parallel Arm Holder

PAH60 (Handed) Door Holder

\$138

\$361

\$421

3

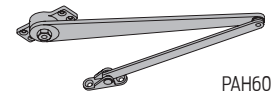

PAH60

Force Gauge

ADA/FG Force Gauge

\$61

1/2



ADA/FG

LCN Spray Paint - Available in single cans or cases of 6 (same color) cans

Can Spray Paint

\$29

Per can

1

Case Spray Paint

132

Per case (6 cans, same color)

4

Fasteners - Individual & Sets

SRT (1 ea.) SRT Screw (1 ea.)

\$1

Self reaming & tapping screw.
Size required. 1 ea.

SRT (Set of 4 ea.) SRT Screw (4 ea.)

3.1

Self reaming & tapping screw.
Size required. 4 ea.

MS (1 ea.) Machine Screw (1 ea.)

1

3

5

Machine screw. Size required. 1 ea.

MS (Set of 4 ea.) Machine Screw (4 ea.)

3.1

10

13

Machine screw. Size required. 4 ea.

WS (1 ea.) Wood Screw (1 ea.)

1

-

-

Wood screw. Size required. 1 ea.

WS (Set of 4 ea.) Wood Screw (4 ea.)

3.1

-

-

Wood screw. Size required. 4 ea.

TORX (1 ea.) TORX Screw (1 ea.)

2.1

6

9

TORX machine screw. Size required. 1 ea.

TORX (Set of 4 ea.) TORX Screw (4 ea.)

5

13

17

TORX machine screw. Size required. 4 ea.

TB 1 3/4" (1 ea.) Thru Bolt, Female

2.1

6

9

Through bolt. 1 3/4" length.

TB 1 3/8" (1 ea.) Thru Bolt, Female

2.1

6

9

Through bolt. 1 3/8" length

TB 1 5/8" (1 ea.) Thru Bolt, Female

2.1

6

9

Through bolt. 1 5/8" length

TB 1 3/4" (Set of 4 ea.) Thru Bolt, Female (4 ea.)

5

21

25

Through bolt. Set of 4 ea. Size required

TB 1 3/8" (Set of 4 ea.) Thru Bolt, Female (4 ea.)

5

21

25

Through bolt. Set of 4 ea. Size required.

TB 1 5/8" (Set of 4 ea.) Thru Bolt, Female (4 ea.)

5

21

25

Through bolt. Set of 4 ea. Size required.

TB/MS (1 ea.) TB(1) & MS(1)

2.1

7

9

TB & MS. Set of 1 ea.

TB/MS (Set of 4 ea.) TB(4) & MS(4)

6

23

33

Size and Series required.
TB & MS. Set of 4 ea.

Torx (Security) Driver Bits

T-10 TORX Bit Torx Bit, T-10

\$14

TORX driver bit, size T-10.

T-15 TORX Bit Torx Bit, T-15

14

TORX driver bit, size T-15.

T-20 TORX Bit Torx Bit, T-20

14

TORX driver bit, size T-20.

T-25 TORX Bit Torx Bit, T-25

14

TORX driver bit, size T-25.

T-27 TORX Bit Torx Bit, T-27

14

TORX driver bit, size T-27.

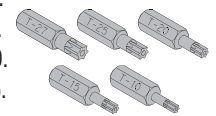

Adjustment Wrenches

T1157 Hold Open Wrench

\$4

Hold Open Adjustment Wrench

Green Hex Wrenches - NOW AVAILABLE!

One end has 3/32" hex for regulation valve adjustment and cover attachment. The other end has 5/32" hex for spring power adjustment.

Great for training seminars.

GHW1 Green Hex Wrench

\$9 Each

Green Hex Wrench. 1 Each.

GHW12 Green Hex Wrench

\$88 / Pack of 12

Green Hex Wrench. Pack of 12

GHW100 Green Hex Wrench

\$604 / Pack of 100

Green Hex Wrench. Pack of 100

CONTROL BOXES PRICE LIST

CONTROL BOXES & COMPRESSORS	PRODUCT DESCRIPTION	LIST PRICE	S H I P P I N G	<h2 style="margin: 0;">May 2019</h2>
PRODUCT NUMBER				

7980 Series Control Boxes

7981.....	Control Box, Pnuematic, Internal Compressor. Self-contained control box/compressor combination for single door application. Includes -3960 Compressor Assembly.	\$3,154	27
7981ES.....	Control Box, Pnuematic, Electric Strike (ES) Relay, Internal Compressor. Self-contained control box/compressor combination for single door application. Includes -3960 Compressor Assembly, -3390A Relay.	3,669	27
7982.....	Control Box, Pnuematic, Internal Compressor Self-contained control box/compressor combination for either independent or simultaneous operation of two (2) door leaves. Includes -3960 Compressor Assembly.	4,465	34
7982S.....	Control Box, Pnuematic, Sequential (S) Feature, Internal Compressor. Self-contained control box/compressor combination for independent, simultaneous or sequential operation of two (2) door leaves. Includes -3960 Compressor Assembly, -3426 Sequencer Card.	4,848	34
7982ES.....	Control Box, Pnuematic, Electric Strike (ES) Relays, Internal Compressor. Self-contained control box/compressor combination for independent or simultaneous operation of two (2) door leaves. Includes -3960 Compressor Assembly, -3390A & -3390B Relays.	5,364	34
7982SES.....	Control Box, Pnuematic, Sequential (S) Feature, Electric Strike (ES) Relays, Internal Compressor. Self-contained control box/compressor combination for independent, simultaneous or sequential operation of two (2) door leaves. Includes -3960 Compressor Assembly, -3390A & -3390B Relays, -3426 Sequencer Card.	5,704	34

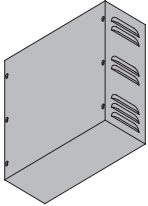

7980 Series Control Box
(15" x 15" x 6")

7900 Series Control Boxes

7901.....	Control Box, Pnuematic Single door application or independent control of single door in multiple door systems. Two door leaves can be operated, if activated simultaneously. Requires a separate 900 Series compressor.	\$2,161	14
7901ES.....	Control Box, Pnuematic Electric Strike (ES) Relay. Single door application or independent control of single door in multiple door systems. Two door leaves can be operated, if activated simultaneously. Includes -3390A Relay. Requires a separate 900 Series compressor.	2,677	14
7902.....	Control Box, Pnuematic Independent operation of two (2) door leaves or simultaneous and/or sequential operation of four (4) door leaves. Requires a separate 900 Series compressor.	2,962	15
7902S.....	Control Box, Pnuematic, Sequential (S) Feature Independent operation of two (2) door leaves or simultaneous operation and/or sequential operation of four (4) door leaves. Includes -3426 Sequencer Card. Requires a separate 900 Series compressor.	3,340	15
7902ES.....	Control Box, Pnuematic, Electric Strike (ES) Relays Independent operation of two (2) door leaves or simultaneous of four (4) door leaves. Includes -3390A & -3390B Relays. Requires a separate 900 Series compressor.	3,872	15
7902SES.....	Control Box, Pnuematic, Sequential (S), Electric Strike (ES) Relays Independent operation of two (2) door leaves or simultaneous and/or sequential operation of four (4) door leaves. Includes -3390A & -3390B Relays, -3426 Sequencer Card. Requires a separate 900 Series compressor.	4,239	15

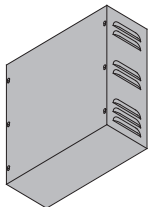

7900 Series Control Box
(15" x 15" x 6")

Note - Locate a 7980 Series Control Box within 50 linear tubing feet of the door. Locate a 7900 Series Control Box within 100 linear tubing feet of the door. Use -925 Pnuematic Tubing to connect operator and control box. 7900 Series Control Boxes require a separate air source, LCN 900 Series Compressors are recommended. For parts & accessories, see pages 28-29.

CONTROL BOXES AND COMPRESSORS

PRICE LIST

CONTROL BOXES & COMPRESSORS			S H I P P I N G	
PRODUCT NUMBER	PRODUCT DESCRIPTION	LIST PRICE		

7940 Series Control Boxes - (Requires LCN 900 series compressor)

7949	Control Box, Pneumatic, Auxiliary 'Blow-Open' Control box works with or without 7901/7902 Series Control Box and one or two pneumatic Auto Equalizers. Controlled by the smoke evacuation system, the 7949 Series Control Box will open the door(s) to allow fresh air into building.	\$1,801	14
7949ES	Control Box, Pneumatic, Auxiliary 'Blow-Open', Electric Strike (ES) Relay. Auxiliary 'blow-open' control box works with or without 7901ES/7902ES Series Control Box and one or two pneumatic Auto Equalizers. Controlled by the smoke evacuation system, the 7949 Series Control Box will unlock and open the door(s) to allow fresh air into building.	2,238	14

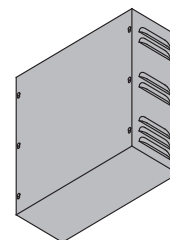

7940 Series Control Box
(15" x 15" x 6")

Note - A 'blow-open' system requires a separate air source. A 'blow-open' system that includes an automatic or power operator function also requires a separate air source and is limited to the operation of two (2) door leaves. In both cases, the LCN 900 Series Compressors are recommended. 7940 Series Control Boxes should be installed within 100 linear tubing feet of the automatic operator(s). For parts & accessories, see pages 28-29.

CONTROL BOX COMPONENTS PRICE LIST



CONTROL BOXES & COMPRESSORS		LIST PRICE	PRODUCT DESCRIPTION
PRODUCT NUMBER	DESCRIPTION		

Control Box Components

293G	Muffler	\$28	Exhaust muffler for 7901, 7902, 7981, or 7982 Series Control Boxes.
319	Fitting, "T"	3.3	"T" fitting to connect 925 pneumatic tubing.
320	Fitting, "Inline"	3.3	"Inline" fitting to connect 925 pneumatic tubing.
329	Air Filter Assembly	69	Replacement inlet air filter for the 7981 or 7982 Series Control Boxes.
329G	Air Filter Assembly	225	Replacement inlet air filter for the 7901 or 7902 Series Control Boxes. Includes -929 Air Filter Assembly.
900	Power Supply, 10T	516	Main power supply/input board for the 7901, 7902, 7981, & 7982 Series Control Boxes. Ten (10) terminals.
903	Timer Module	229	0-30 second timer module for 7901, 7902, 7981, & 7982 Series Control Box. Plugs into the -900 Power Supply Board.
925	Pneumatic Tubing	2.20/ft	Flexible pneumatic tubing with an 1/8" inner diameter & 1/4" outer diameter. Specify number of linear feet required when ordering.
929	Filter & Seal	30	Internal filter & seal component to the 329G Air Filter Assembly.
941	Valve Assembly	776	Regulator valve assembly for the 7901 series control box.
941C	Valve Assembly	776	Regulator valve assembly for the 7949 series control box.
942	Valve Assembly	1,498	Regulator valve assembly for the 7902 series control box.
962	Isolator	24	Rubber isolator for 7981 or 7982 compressor (-3960) assembly.

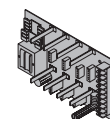

900



903

Control Box Components

3299A	Solenoid Assembly Valve 'A'	439	Air valve assembly for the 7981 Series Control Box or the 'A' circuit valve assembly in the 7982 Series Control Box.
3299B	Solenoid Assembly Valve 'B'	475	Air valve assembly for the 'B' circuit in the 7982 Series Control Box.
3328	Copper Coupler	25	Converts pneumatic tubing connection to copper.
3390A	'A' Relay Package	518	Electric strike (ES) relay for 7901 and 7982 Series Control Boxes or the 'A' circuit ES relay assembly used in the 7902 and 7982 Series Control Boxes. Can be added to a standard control box to convert to ES operation. Includes -390 Relay, relay base and wire harness. The 3390A is included when either a 7901ES, 7902ES, 7981ES or 7982ES is ordered.
3390B	'B' Relay Package	518	Electric strike (ES) relay for 'B' circuit in either the 7902 or 7982 Series Control Boxes. Can be added to a standard control box to convert to ES operation. Includes -390 Relay, relay base and wire harness. The 3390B is included when either a 7902ES or 7982ES is ordered.
3390C	'C' Relay Package	518	Electric strike (ES) relay assembly for the 7949 series 'blow-open' control box. Includes -390C Relay, relay base and wire harness. The 3390C is included when a 7949ES is ordered.
3426	Sequencer Card	347	Dual, 0-30 second timer module for 7902 or 7982 Series Control Box. Can be added to a standard 7902 or 7982 Series Control Box to convert box to sequential operation. -3426 Sequencer card is included when either a 7902S or 7982S Series Control Box is ordered.
3592	Compressor Service Kit	73	Service kit for air pressure adjustment in the either the 7981 or 7982 Series Control Box.
3960	Compressor Assembly	1,947	Internal air pump assembly for the 7981 or 7982 Series Control Box. -3960 Compressor Assembly includes starter capacitor, -962 Isolators and -329 Air Filter Assembly.

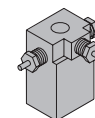

3299A

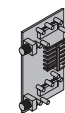

3426

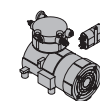

3960

CONTROL BOX COMPONENTS

Control Box Components



293G



329G



329

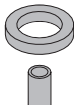

929



962

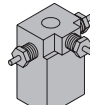

3299A



3299B



3390A

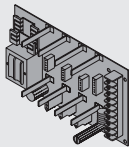

900

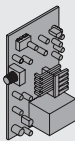

903

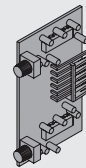

3426

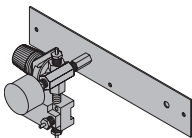

941

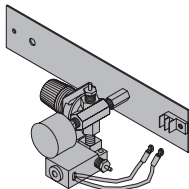

941C

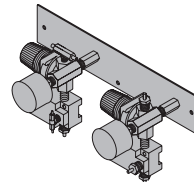

942



925

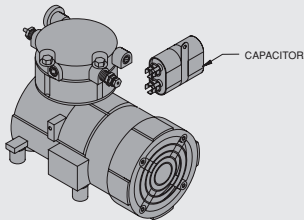

3960

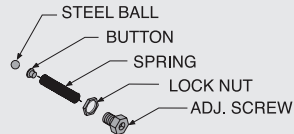

3592

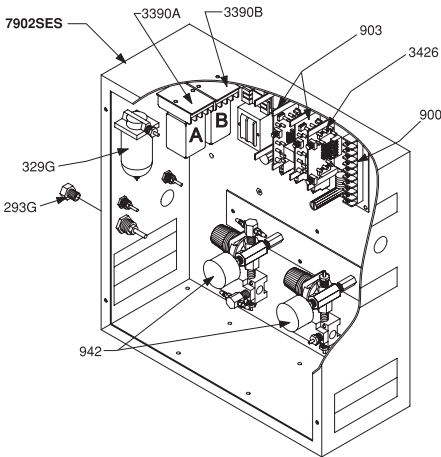

7902SES

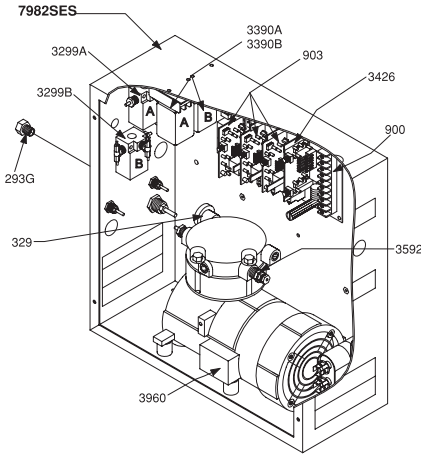

7982SES

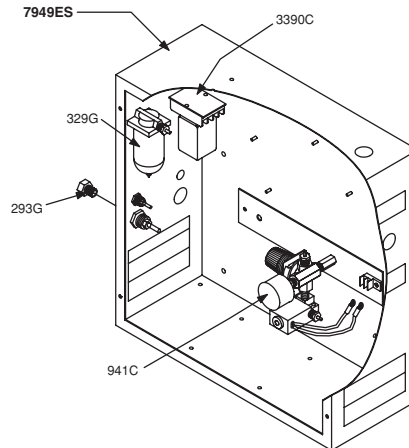

7949ES

Actuator/Sensor Quick Find PRICE LIST

ACTUATOR/SENSOR QUICK FIND GUIDE		LIST PRICE	PRODUCT DESCRIPTION
PRODUCT NUMBER	ITEM PAGE(S)		
8310-800	40	\$24	Ring, Weather, 4½" Round
8310-801	40	24	Ring, Weather, 4½" x 4½"
8310-802	40	24	Ring, Weather, 6" Round
8310-804-1	42	1,290	Sensor, Door Mount, Safety
8310-804-2	42	1,753	Sensor, Door Mount, Safety
8310-805	44	57	Switch, Door Position
8310-805C	44	57	Switch, Door Position
8310-806K	48	215	Switch, Key
8310-806R	48	215	Switch, Rocker
8310-807	48	215	Filter, Line
8310-813	34	946	Actuator, Wall Mount, 4¾" x 4¾"
8310-818	32	178	Actuator, Jamb Mount, Logo, 1½" x 4¾"
8310-818T	32	178	Actuator, Jamb Mount, Logo, Text, 1½" x 4¾"
8310-819F	40	39	Box Only, Jamb Mount, Flush Mount, 1½" x 4¾"
8310-819S	40	39	Box Only, Jamb Mount, Surface Mount, 1½" x 4¾"
8310-824	44	83	Transformer
8310-824P	44	83	Transformer
8310-836T	36	1,009	Actuator, Full Length, Logo, Text, 36" x 6"
8310-836TW	36	1,147	Actuator, Full Length, Logo, Text, Wireless, 36" x 6"
8310-844	46	202	Transmitter Kit, Wall Mount, 9v
8310-844J	46	202	Transmitter Kit, Jamb Mount, 3v
8310-845	48	330	Relay and Door Sequencer
8310-846	44	29	Harness, Header Mount
8310-847	44	116	Harness, Door Mount
8310-852	36	273	Actuator, Wall Mount, Logo, 6" Round
8310-852T	36	273	Actuator, Wall Mount, Logo, Text, 6" Round
8310-852TA	36	273	Actuator, Wall Mount, Active Logo, Text, 6" Round
8310-852TWP	36	710	Actuator, Wall Mount, Logo, Text, Wireless, Package, 6" Round
8310-852WP	36	710	Actuator, Wall Mount, Logo, Wireless, Package, 6" Round
8310-853	34	260	Actuator, Wall Mount, Logo, 4¾" x 4¾"
8310-853T	34	260	Actuator, Wall Mount, Logo, Text, 4¾" x 4¾"
8310-853TA	34	260	Actuator, Wall Mount, Active Logo, Text, 4¾" x 4¾"
8310-853TWP	34	710	Actuator, Wall Mount, Logo, Text, Wireless, Package, 4¾" x 4¾"
8310-853WP	34	710	Actuator, Wall Mount, Logo, Wireless, Package, 4¾" x 4¾"
8310-854	42	804	Sensor, Header Mount, Activation
8310-854ECA	44	208	Bracket, Drop Ceiling
8310-854ERA	44	141	Cover, Protective
8310-855	34	415	Actuator, Wall Mount, Logo, Dual Vestibule
8310-856	32	206	Actuator, Wall Mount, Logo
8310-856T	32	206	Actuator, Wall Mount, Logo, Text
8310-859	44	178	Remote, Handheld
8310-861	46	202	Transmitter, Handheld, 1 Channel
8310-862	46	202	Transmitter, Handheld, 2 Channel
8310-863	46	202	Transmitter, Handheld, 3 Channel
8310-864	46	202	Transmitter, Handheld, 4 Channel
8310-865	32, 34, 36, 46	212	Receiver
8310-866	46	930	Post, Bollard, Accommodates Bollard Actuator, 42" x 4" x 6"
8310-866FLA	46	930	Post, Bollard, Accommodates Full Length Actuator, 42" x 4" x 6"
8310-866CAP	46	152	Cap



Actuator/Sensor Quick Find PRICE LIST

ACTUATOR/SENSOR QUICK FIND GUIDE		LIST PRICE	PRODUCT DESCRIPTION
PRODUCT NUMBER	ITEM PAGE(S)		
8310-867F	40	\$170	Box, Flush Mount, 4¾" x 4¾"
8310-867S	40	170	Box, Surface Mount, 4¾" x 4¾"
8310-868F	40	153	Box, Flush Mount, 4½" Round
8310-868S	40	153	Box, Surface Mount, 4½" Round
8310-869F	40	165	Box, Flush Mount, 6" Round
8310-869S	40	165	Box, Surface Mount, 6" Round
8310-874	40	379	Escutcheon, 4½" Round
8310-876	40	379	Escutcheon, 6" Round
8310-877S	44	166	Spacer, Header Mount
8310-3803	44	587	Conversion Kit, Wireless, Jamb Mount
8310-3809	44	587	Conversion Kit, Wireless, Wall Mount
8310-3818TWF	32	398	Actuator, Jamb Mount, Logo, Text, Wireless, Flush, 1½" x 4¾"
8310-3818TWS	32	398	Actuator, Jamb Mount, Logo, Text, Wireless, Surface, 1½" x 4¾"
8310-3818WF	32	398	Actuator, Jamb Mount, Logo, Wireless, Flush, 1½" x 4¾"
8310-3818WS	32	398	Actuator, Jamb Mount, Logo, Wireless, Surface, 1½" x 4¾"
8310-3822T	38	411	Actuator Package, Logo, Text, 1½" x 4¾"
8310-3822TW	38	805	Actuator Package, Logo, Text, Wireless, 1½" x 4¾"
8310-3836T	46	1,843	Full Length Actuator / Bollard Package
8310-3836TW	46	2,023	Full Length Actuator / Bollard Package, Wireless
8310-3852TWF	36	629	Actuator, Wall Mount, Logo, Text, Wireless, Flush, 6" Round
8310-3852TWS	36	629	Actuator, Wall Mount, Logo, Text, Wireless, Surface, 6" Round
8310-3852WF	36	629	Actuator, Wall Mount, Logo, Wireless, Flush, 6" Round
8310-3852WS	36	629	Actuator, Wall Mount, Logo, Wireless, Surface, 6" Round
8310-3853TWB	46	439	Actuator, Bollard, Logo, Text, Wireless, 4¾" x 4¾"
8310-3853TWF	34	624	Actuator, Wall Mount, Logo, Text, Flush, 4¾" x 4¾"
8310-3853TWS	34	624	Actuator, Wall Mount, Logo, Text, Surface, 4¾" x 4¾"
8310-3853WB	46	439	Actuator, Bollard, Logo, Wireless, 4¾" x 4¾"
8310-3853WF	34	624	Actuator, Wall Mount, Logo, Wireless, Flush, 4¾" x 4¾"
8310-3853WS	34	624	Actuator, Wall Mount, Logo, Wireless, Surface, 4¾" x 4¾"
8310-3855WF	34	962	Actuator, Wall Mount, Logo, Wireless, Flush, Dual Vestibule, 4¾" x 4¾"
8310-3855WS	34	962	Actuator, Wall Mount, Logo, Wireless, Surface, Dual Vestibule, 4¾" x 4¾"
8310-3856TWF	32	555	Actuator, Wall Mount, Logo, Text, Wireless, Flush, 4½" Round
8310-3856TWS	32	555	Actuator, Wall Mount, Logo, Text, Wireless, Surface, 4½" Round
8310-3856WF	32	555	Actuator, Wall Mount, Logo, Wireless, Flush, 4½" Round
8310-3856WS	32	555	Actuator, Wall Mount, Logo, Wireless, Surface, 4½" Round
8310-3857T	38	820	Actuator Package, Logo, Text, 4¾" x 4¾"
8310-3857TW	38	1,449	Actuator Package, Logo, Text, Wireless, 4¾" x 4¾"
8310-3860T	38	683	Actuator Package, Logo, Text, 4½" Round
8310-878	42	4,383	Sensor Package
8310-879	42	8,332	Sensor Package
8310-3860TW	38	1,314	Actuator Package, Logo, Text, Wireless, 4½" Round
8310-3881	42	5,978	Sensor Package
8310-3882	42	9,999	Sensor Package
8310-3883	42	1,743	Sensor Package
8310-3888	44	37	Harness, Safety Module
8310-3889	44	524	Safety Module Kit
8310-3891	42	8,500	Sensor Package
8310-3892	42	9,999	Sensor Package



ACTUATORS & ACCESSORIES

PRICE LIST

ACTUATORS & ACCESSORIES		LIST PRICE	PRODUCT DESCRIPTION	
PRODUCT NUMBER	DESCRIPTION			

8310 Series Actuators - Jamb Mount - 1-1/2" x 4-3/4" Rectangle - Interior Installation Only

8310-818	Actuator, Jamb Mount	\$178	Actuator, 1-1/2" x 4-3/4" Rectangle, Logo
8310-818T	Actuator, Jamb Mount	178	Actuator, 1-1/2" x 4-3/4" Rectangle, Logo, Text
8310-3818WF	Actuator, Jamb Mount	398	Actuator, 1-1/2" x 4-3/4" Rectangle, Logo, Wireless, Flush Mount Includes 8310-818 Actuator, 8310-844J Transmitter Kit, 8310-819F Flush Box. Requires 8310-865 Receiver.
8310-3818WS	Actuator, Jamb Mount	398	Actuator, 1-1/2" x 4-3/4" Rectangle, Logo, Wireless, Surface Mount Includes 8310-818 Actuator, 8310-844J Transmitter Kit, 8310-819S Surface Box. Requires 8310-865 Receiver.
8310-3818TWF	Actuator, Jamb Mount	398	Actuator, 1-1/2" x 4-3/4" Rectangle, Logo, Text, Wireless, Flush Mount Includes 8310-818T Actuator, 8310-844J Transmitter Kit, 8310-819F Flush Box. Requires 8310-865 Receiver.
8310-3818TWS	Actuator, Jamb Mount	398	Actuator, 1-1/2" x 4-3/4" Rectangle, Logo, Text, Wireless, Surface Mount Includes 8310-818T Actuator, 8310-844J Transmitter Kit, 8310-819S Surface Box. Requires 8310-865 Receiver.
8310-865	Receiver	212	Receiver, Wireless, 1 Channel, Sequencing Feature Used in conjunction w/ Wireless Actuators & Transmitters



8310-818



8310-818T

8310 Series Actuators - Wall Mount - 4-1/2" Round

8310-856	Actuator, Wall Mount	\$206	Actuator, 4-1/2" Round, Logo
8310-856T	Actuator, Wall Mount	206	Actuator, 4-1/2" Round, Logo, Text
8310-3856WF	Actuator, Wall Mount	555	Actuator, 4-1/2" Round, Logo, Wireless, Flush Mount. Includes 8310-856 Actuator, 8310-844 Transmitter Kit, 8310-868F Flush Box, 8310-800 Weather Ring. Requires 8310-865 Receiver.
8310-3856WS	Actuator, Wall Mount	555	Actuator, 4-1/2" Round, Logo, Wireless, Surface Mount Includes 8310-856 Actuator, 8310-844 Transmitter Kit, 8310-868S Surface Box, 8310-800 Weather Ring. Requires 8310-865 Receiver.
8310-3856TWF	Actuator, Wall Mount	555	Actuator, 4-1/2" Round, Logo, Text, Wireless, Flush Mount Includes 8310-856T Actuator, 8310-844 Transmitter Kit, 8310-868F Flush Box, 8310-800 Weather Ring. Requires 8310-865 Receiver.
8310-3856TWS	Actuator, Wall Mount	555	Actuator, 4-1/2" Round, Logo, Text, Wireless, Surface Mount Includes 8310-856T Actuator, 8310-844 Transmitter Kit, 8310-868S Surface Box, 8310-800 Weather Ring. Requires 8310-865 Receiver.
8310-865	Receiver	212	Receiver, Wireless, 1 Channel, Sequencing Feature Used in conjunction w/ Wireless Actuators & Transmitters









8310-856

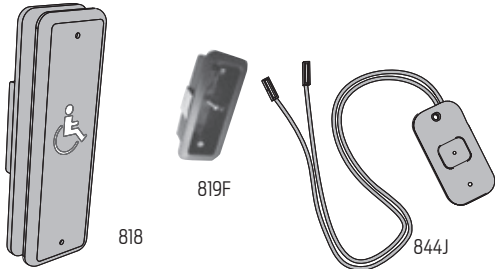
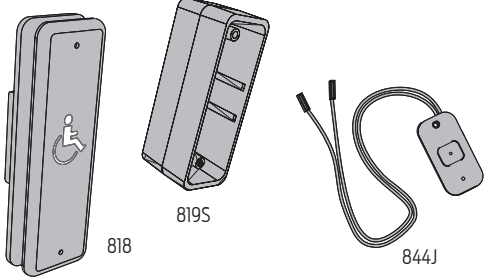

8310-856T

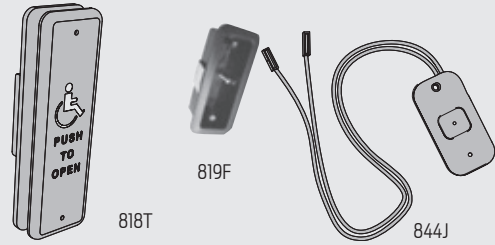
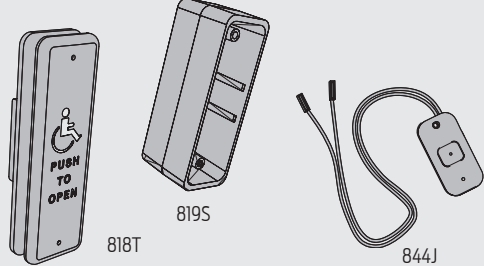
8310 Series Actuators

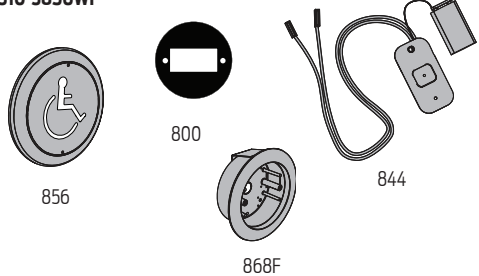
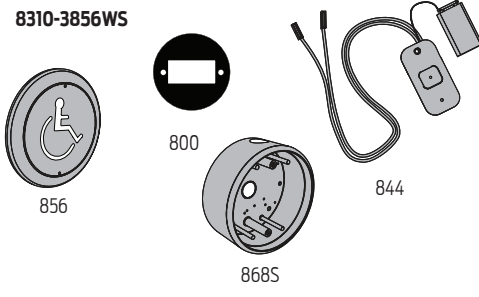

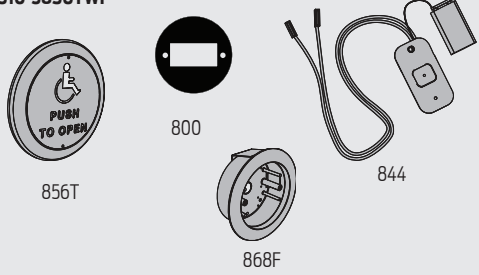
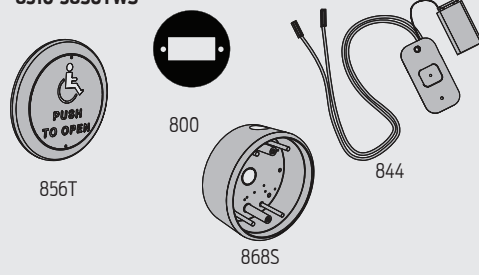
<p>8310-818</p> 	<p>8310-3818WF</p>  <p>819F 818 844J</p>	<p>8310-3818WS</p>  <p>819S 818 844J</p>
<p>8310-818T</p> 	<p>8310-3818TWF</p>  <p>819F 818T 844J</p>	<p>8310-3818TWS</p>  <p>819S 818T 844J</p>
<p>8310-856</p> 	<p>8310-3856WF</p>  <p>800 856 868F 844</p>	<p>8310-3856WS</p>  <p>800 856 868S 844</p>
<p>8310-856T</p> 	<p>8310-3856TWF</p>  <p>800 856T 868F 844</p>	<p>8310-3856TWS</p>  <p>800 856T 868S 844</p>

ACTUATORS & ACCESSORIES

PRICE LIST

ACTUATORS & ACCESSORIES		LIST PRICE	PRODUCT DESCRIPTION
PRODUCT NUMBER	DESCRIPTION		



8310 Series Actuators - Wall Mount - 4-3/4" Square

8310-853	Actuator, Wall Mount	\$260	Actuator, 4-3/4" Square, Logo
8310-853T	Actuator, Wall Mount	260	Actuator, 4-3/4" Square, Logo, Text
8310-853TA	Actuator, Wall Mount	260	Actuator, 4-3/4" Square, Active Logo, Text
8310-853WP	Actuator, Wall Mount	710	Actuator, 4-3/4" Square, Logo, Wireless, Surface Mount Easy mount, 'all in one', low profile, surface mount, wireless actuator. Requires 8310-865 Receiver
8310-853TWP	Actuator, Wall Mount	710	Actuator, 4-3/4" Square, Logo, Text, Wireless, Surface Mount Easy mount, 'all in one', low profile, surface mount, wireless actuator. Requires 8310-865 Receiver
8310-3853WF	Actuator, Wall Mount	624	Actuator, 4-3/4" Square, Logo, Wireless, Flush Mount Includes 8310-853, 8310-844 Transmitter Kit, 8310-867F Flush Box, 8310-801 Weather Ring. Requires 8310-865 Receiver
8310-3853WS	Actuator, Wall Mount	624	Actuator, 4-3/4" Square, Logo, Wireless, Surface Mount Includes 8310-853, 8310-844 Transmitter Kit, 8310-867S Surface Box, 8310-801 Weather Ring. Requires 8310-865 Receiver
8310-3853TWF	Actuator, Wall Mount	624	Actuator, 4-3/4" Square, Logo, Text, Wireless, Flush Mount Includes 8310-853T, 8310-844 Transmitter Kit, 8310-867F Flush Box, 8310-801 Weather Ring. Requires 8310-865 Receiver
8310-3853TWS	Actuator, Wall Mount	624	Actuator, 4-3/4" Square, Logo, Text, Wireless, Surface Mount Includes 8310-853T, 8310-844 Transmitter Kit, 8310-867S Surface Box, 8310-801 Weather Ring. Requires 8310-865 Receiver
8310-865	Receiver	212	Receiver, Wireless, 1 Channel, Sequencing Feature Used in conjunction w/ Wireless Actuators & Transmitters

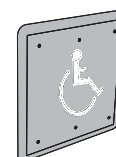

8310-853



8310-853T



8310-855

8310 Series Actuators - Wall Mount - 4-3/4" Square

8310-813	Actuator, Wall Mount	\$946	Actuator, 4-3/4" Square, Touchless, Wall Mount 'K' Band Technology 'Hands Free' operation, system is activated by movement near actuator face. Mounts in 4" x 4" electrical box - Includes black plexiglass cover
8310-855	Actuator, Wall Mount	415	Actuator, 4-3/4" Square, Logo, Dual Vestibule
8310-3855WF	Actuator, Wall Mount	962	Actuator, 4-3/4" Square, Logo, Dual Vestibule, Wireless, Flush Mount Includes 8310-855 Actuator, 8310-844 Transmitter (2), 8310-867F Flush Box, 8310-801 Weather Ring. Requires 8310-865 Receiver (2)
8310-3855WS	Actuator, Wall Mount	962	Actuator, 4-3/4" Square, Logo, Dual Vestibule, Wireless, Surface Mount Includes 8310-855 Actuator, 8310-844 Transmitter (2), 8310-867S Surface Box, 8310-801 Weather Ring. Requires 8310-865 Receiver (2)
8310-865	Receiver	212	Receiver, Wireless, 1 Channel, Sequencing Feature Used in conjunction w/ Wireless Actuators & Transmitters

8310 Series Actuators



8310-853

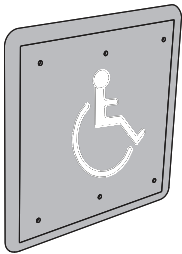

8310-3853WF



853

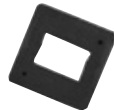

801

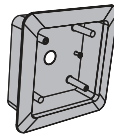

867F



844

8310-3853WS



853

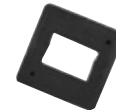

801

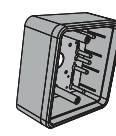

867S



844

8310-853T

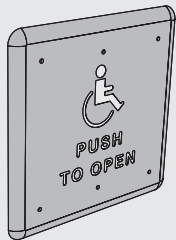

8310-3853TWF



853T

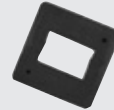

801

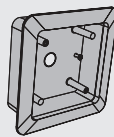

867F



844

8310-3853TWS



853T

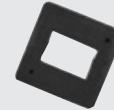

801

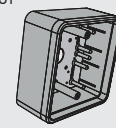

867S

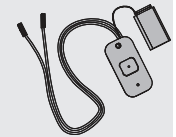

844

8310-853WP



8310-853TWP

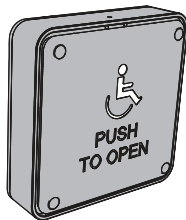

8310-813

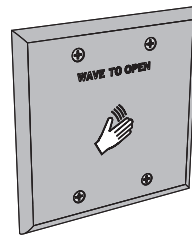

8310-865

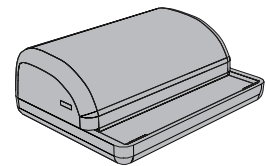

8310-855



8310-3855WF



855

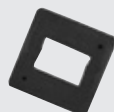

801

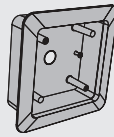

867F



844

8310-3855WS



855

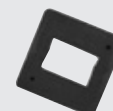

801

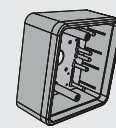

867S

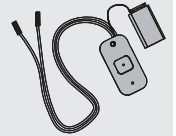





844

ACTUATORS & ACCESSORIES

PRICE LIST

ACTUATORS & ACCESSORIES		LIST PRICE	PRODUCT DESCRIPTION	
PRODUCT NUMBER	DESCRIPTION			

8310 Series Actuators - Wall Mount - 6" Round

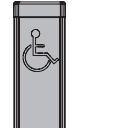
8310-852	Actuator, Wall Mount	\$273	Actuator, 6" Round, Logo	 8310-852
8310-852T	Actuator, Wall Mount	273	Actuator, 6" Round, Logo, Text	
8310-852TA	Actuator, Wall Mount	273	Actuator, 6" Round, Active Logo, Text	 8310-852T
8310-852WP	Actuator, Wall Mount	710	Actuator, 6" Round, Logo, Wireless, Surface Mount Easy mount, 'all in one', low profile, surface mount, wireless actuator. Requires 8310-865 Receiver.	
8310-852TWP	Actuator, Wall Mount	710	Actuator, 6" Round, Logo, Text, Wireless, Surface Mount Easy mount, 'all in one', low profile, surface mount, wireless actuator. Requires 8310-865 Receiver.	 8310-852WP
8310-3852WF	Actuator, Wall Mount	629	Actuator, 6" Round, Logo, Wireless, Flush Mount Includes 8310-852 Actuator, 8310-844 Transmitter Kit, 8310-869F Flush Box, 8310-802 Weather Ring. Requires 8310-865 Receiver.	
8310-3852WS	Actuator, Wall Mount	629	Actuator, 6" Round, Logo, Wireless, Surface Mount Includes 8310-852 Actuator, 8310-844 Transmitter Kit, 8310-869S Surface Box, 8310-802 Weather Ring. Requires 8310-865 Receiver.	 8310-852TWP
8310-3852TWF	Actuator, Wall Mount	629	Actuator, 6" Round, Logo, Text, Wireless, Flush Mount Includes 8310-852T Actuator, 8310-844 Transmitter Kit, 8310-869F Flush Box, 8310-802 Weather Ring. Requires 8310-865 Receiver.	
8310-3852TWS	Actuator, Wall Mount	629	Actuator, 6" Round, Logo, Text, Wireless, Surface Mount Includes 8310-852T Actuator, 8310-844 Transmitter Kit, 8310-869S Surface Box, 8310-802 Weather Ring. Requires 8310-865 Receiver.	 8310-852TWP
8310-865	Receiver	212	Receiver, Wireless, 1 Channel, Sequencing Feature Used in conjunction w/ Wireless Actuators & Transmitters	

8310 Series Actuators - Specialty

8310-836T	Actuator, Full Length	1,009	Actuator, 36" x 6" Full Length, Logo, Text	 8310-836T
8310-836TW	Actuator, Full Length	1,147	Actuator, 36" x 6" Full Length, Logo, Text, Wireless Requires 8310-865. Easy Mount, All-In-One, Low Profile Surface Mount, Wireless Actuator.	

8310 Series Actuators

May
2019

8310-852



3852WF

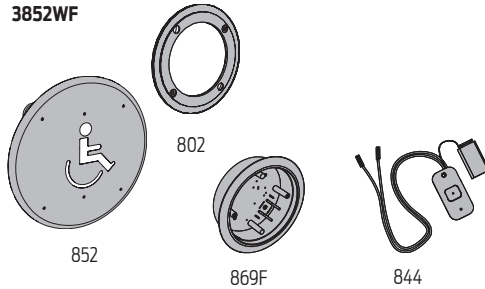

3852WS

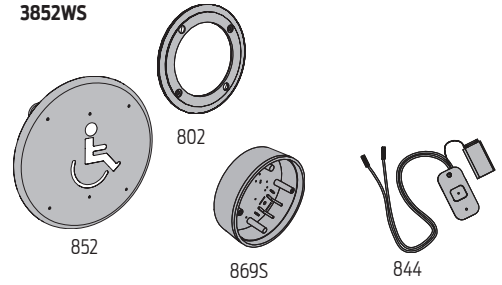

8310-852T



3852TWF

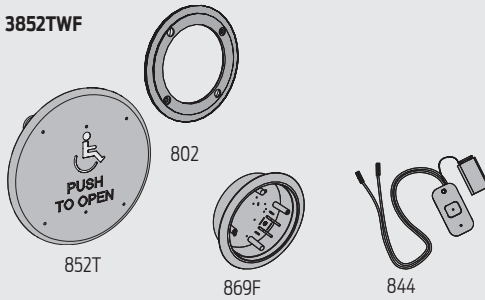

3852TWS

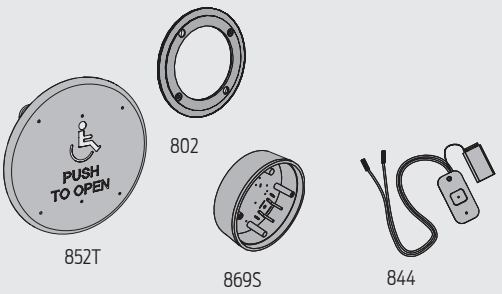

8310-852WP



8310-852TWP



8310-865

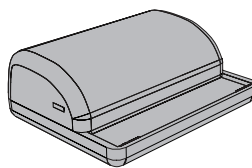

8310-836T



8310-836TW

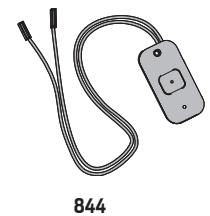
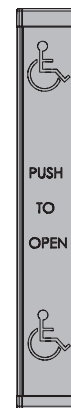

844

836T

ACTUATORS & ACCESSORIES

PRICE LIST

ACTUATORS & ACCESSORIES		LIST PRICE	PRODUCT DESCRIPTION
PRODUCT NUMBER	DESCRIPTION		



8310 Series Actuators - Wall Mount - 4-3/4" Square

8310-3822T	Actuator Package	\$411	Actuator Package, 1-1/2" x 4-3/4", Jamb Mount Includes 8310-818T (2) Jamb Mount Actuator, (2) 8310-819S Surface Mount Box. Recommended for interior use only.
8310-3822TW	Actuator Package	805	Actuator Package, 1-1/2" x 4-3/4", Wireless, Jamb Mount Includes 8310-818T (2) Jamb Mount Actuator, 8310-819S (2) Surface Mount Box, 8310-844J (2) Jamb Mount Transmitter, 8310-865 Receiver. Recommended for interior use only.
8310-3860T	Actuator Package	683	Actuator Package, 4-1/2" Round, Wall Mount. Includes 8310-856T (2) Wall Mount Actuator, 8310-868S (2) Surface Mount Box
8310-3860TW	Actuator Package	1,314	Actuator Package, 4-1/2" Round, Wireless, Wall Mount Includes 8310-856T (2) Wall Mount Actuator, 8310-868S (2) Surface Mount Box, 8310-800 (2) Weather Ring, 8310-844 (2) Transmitter, 8310-865 Receiver
8310-3857T	Actuator Package	820	Actuator Package, 4-3/4" Square, Wall Mount. Includes 8310-853T (2) Wall Mount Actuator, 8310-867S (2) Surface Mount Box
8310-3857TW	Actuator Package	1,449	Actuator Package, 4-3/4" Square, Wall Mount. Includes 8310-853T (2) Wall Mount Actuator, 8310-867S (2) Surface Mount Box, 8310-801 (2) Weather Ring, 8310-844 (2) Transmitter, 8310-865 Receiver

8310 Series Actuator Packages

May
2019

8310-3822T

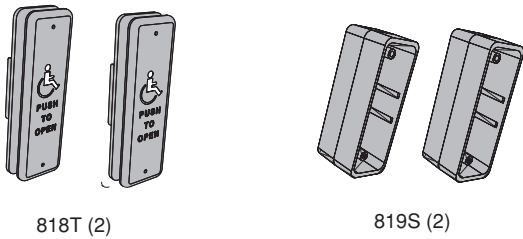

818T (2)

819S (2)

8310-3822TW

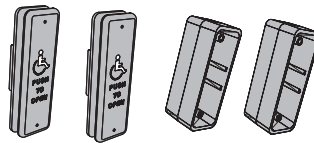

818T (2)

819S (2)

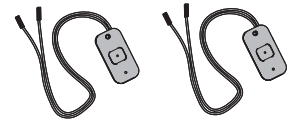

844J (2)

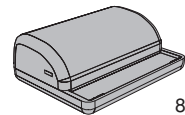

865

8310-3860T

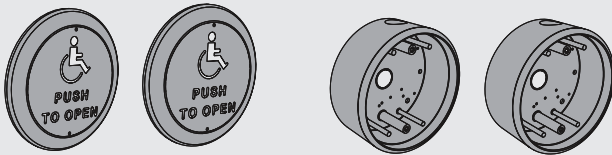

856T (2)

868S (2)

8310-3860TW

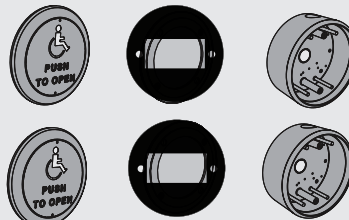

856T (2)

800 (2)

868S (2)



844 (2)

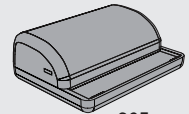

865

8310-3857T

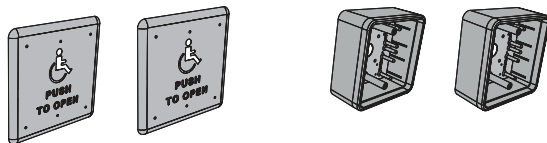

853T (2)

867S (2)

8310-3857TW

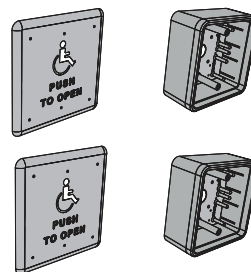

853T (2)

867S (2)



801 (2)



844 (2)

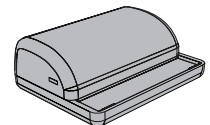



865

ACTUATORS & ACCESSORIES

PRICE LIST

ACTUATORS & ACCESSORIES		LIST PRICE	PRODUCT DESCRIPTION	
PRODUCT NUMBER	DESCRIPTION			

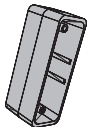
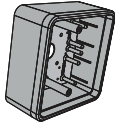
8310 Series Actuator Accessories

8310-800	Ring, Weather	\$24	Weather Ring, 4-1/2" Round Optional accessory. Can be used w/ any 4-1/2" round actuator	 8310-800
8310-801	Ring, Weather	24	Weather Ring, 4-1/2" Square Optional accessory. Can be used w/ any 4-1/2" square actuator	
8310-802	Ring, Weather	24	Weather Ring, 6" Round Optional accessory. Can be used w/ any 6" round actuator	
8310-819F	Box Only, Jamb Mount	39	Jamb Box Only, 1-1/2" x 4-3/4" Rectangle, Flush Mount Optional accessory. Should be used on an interior installation Can be used w/ any 1-1/2" x 4-3/4" jamb mount actuator	 8310-819S
8310-819S	Box Only, Jamb Mount	39	Jamb Box Only, 1-1/2" x 4-3/4", Rectangle, Surface Mount Optional accessory. Should be used on an interior installation only. Can be used w/ any 1-1/2" x 4-3/4" jamb mount actuator	
8310-867F	Box, Flush Mount	170	Box Only, 4-3/4" Square, Flush Mount Optional accessory. Can be used w/ any 4-3/4" square actuator	 8310-867S
8310-867S	Box, Surface Mount	170	Box Only, 4-3/4" Square, Surface Mount Optional accessory. Can be used w/ any 4-3/4" square actuator	
8310-868F	Box, Flush Mount	153	Box Only, 4-1/2" Round, Flush Mount Optional accessory. Can be used w/ any 4-1/2" round actuator	 8310-868S
8310-868S	Box, Surface Mount	153	Box Only, 4-1/2" Round, Surface Mount Optional accessory. Can be used w/ any 4-1/2" round actuator	
8310-869F	Box, Flush Mount	165	Box Only, 6" Round, Flush Mount Optional accessory. Can be used w/ any 6" round actuator	 8310-869S
8310-869S	Box, Surface Mount	165	Box Only, 6" Round, Surface Mount Optional accessory. Can be used w/ any 6" round actuator	
8310-874	Escutcheon	379	Escutcheon, 4-1/2" Round, Decorative, Protective Optional accessory. Can be used w/ any 4-1/2" round actuator	
8310-876	Escutcheon	379	Escutcheon, 6" Round, Decorative, Protective Optional accessory. Can be used w/ any 6" round actuator	

8310 Series Actuator Accessories



8310-800

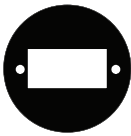

8310-801



8310-802

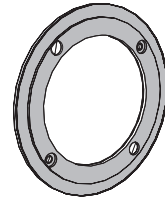

8310-819F



8310-819S

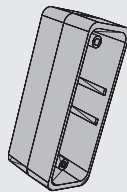

8310-867F

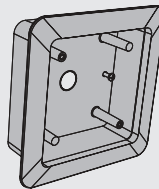

8310-867S

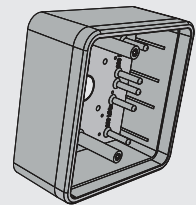

8310-868F

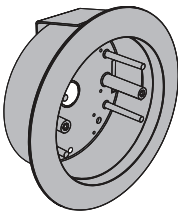

8310-868S

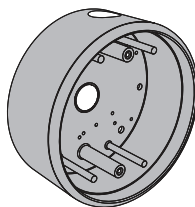

8310-869F

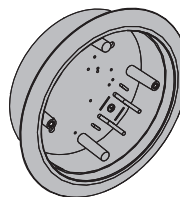

8310-869S

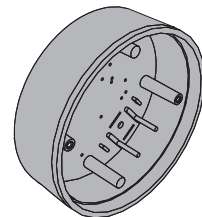

8310-874

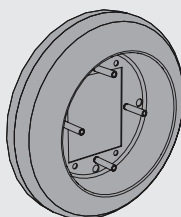

8310-876

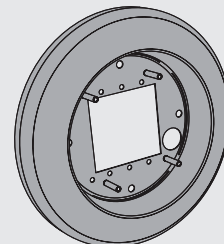

ACTUATORS & ACCESSORIES

PRICE LIST

ACTUATORS & ACCESSORIES		LIST PRICE	PRODUCT DESCRIPTION	
PRODUCT NUMBER	DESCRIPTION			

8310 Series Activation/Safety Sensors

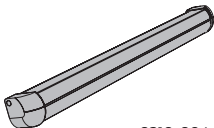
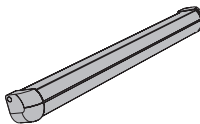
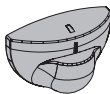
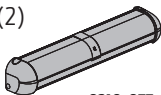
8310-804-1	Sensor, Door Mount, Safety	\$1,290	Door Mount Safety Sensor, Sensor with one element Used to sense obstruction(s) on leading edge of	
8310-804-2	Sensor, Door Mount, Safety	1,753	Door Mount Safety Sensor, Sensor with two elements Used to sense obstruction(s) on full face of door	
8310-854	Sensor, Header Mount, Activation	804	Header Mount Activation Sensor, 'K' Band Technology	
8310-877	Sensor, Header Mount, Safety	1,536	Header Mount Safety Sensor, 'Diffused Infrared' Technology Provides 'safety function' during door open & door closed position. Nine selectable/programmable patterns. Optional 8310-859 Handheld Remote Control can be used to program 8310-877 Sensor from a distance. Includes 8310-846 Harness.	

8310 Series Activation/Safety Sensor Packages

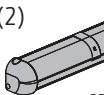
8310-878	Sensor Package	\$4,383	Monitored Safety Sensor Kit for single door applications. Contains two (2) door-mounted sensors and a control hub that perform the swing door safety functions and provides the sensor monitoring required by A156.10. All wire harnesses and mounting hardware included.	
8310-879	Sensor Package	8,332	Monitored Safety Sensor Kit for all double door applications. Contains four (4) door-mounted sensors and a control hub that perform the swing door safety functions and provides the sensor monitoring required by A156.10. All wire harnesses and mounting hardware included.	
8310-3881	Sensor Package	5,978	Safety Sensor Package. Includes 8310-854 (2) Header Mount Activation Sensor & 8310-878 Monitored Safety Sensor Kit (Used with Senior Swing Only)	
8310-3882	Sensor Package	9,999	Safety Sensor Package. Includes 8310-854 (2) Header Mount Activation Sensor & 8310-879 Monitored Safety Sensor Kit (Used with Senior Swing Only)	
8310-3883	Sensor Package	1,743	Activation/Safety Sensor Package, Low Energy Convenience, Single Door. Includes 8310-804-1 Door Mount Safety Sensor, 8310-805C Door Position Switch (Concealed), 8310-845 Programmable Relay Module	
8310-3891	Sensor Package	8,500	Activation/Safety Sensor Package, Health Care I, Simultaneous Pair Includes 8310-877 Header Mount Sensor, 8310-877S Header Mount Spacer, 8310-804-2 (4) Door Mount Sensor, 8310-847 (2) Harness.	
8310-3892	Sensor Package	9,999	Activation/Safety Sensor Package, Health Care II, Independent Pair Includes 8310-877 (2) Header Mount Sensor, 8310-877S (2) Header Mount Spacer, 8310-804-2 (4) Door Mount Sensor, 8310-847 (2) Harness	

8310 Series Activation/Safety Sensor Packages

May
2019

8310-804-1

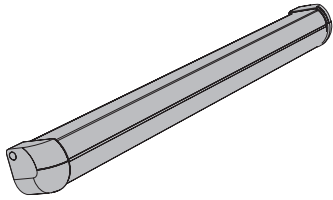

8310-804-2

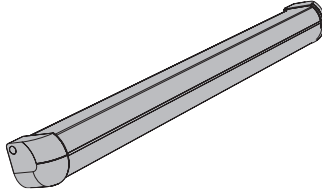

8310-854



8310-877

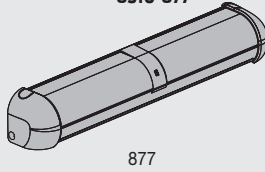

877

8310-3883



804-1

805C

845

8310-3891

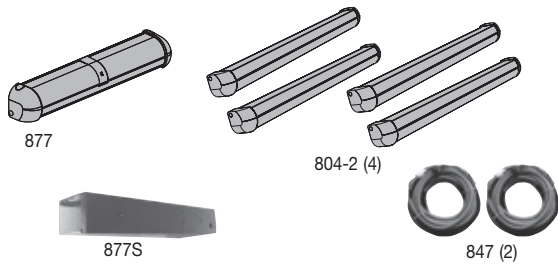

877

804-2 (4)

877S

847 (2)

8310-3892

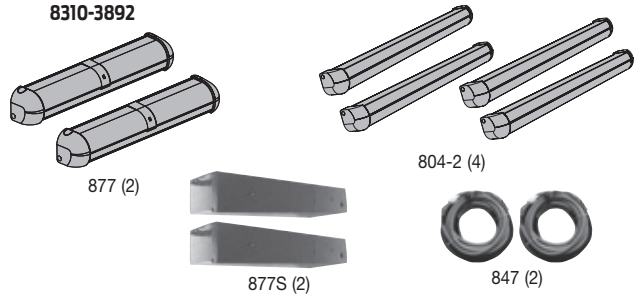

877 (2)

804-2 (4)

877S (2)

847 (2)

8310-3881

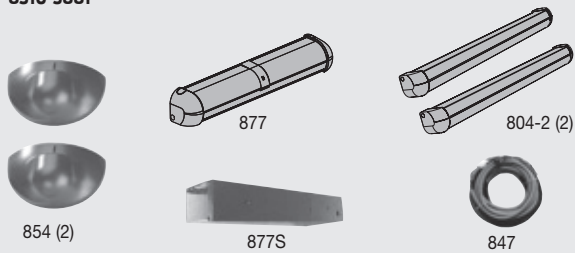

854 (2)

877

804-2 (2)

877S

847

8310-3882

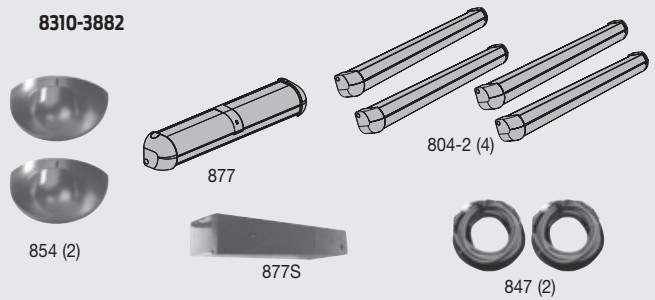

854 (2)

877

804-2 (4)

877S

847 (2)

8310-878

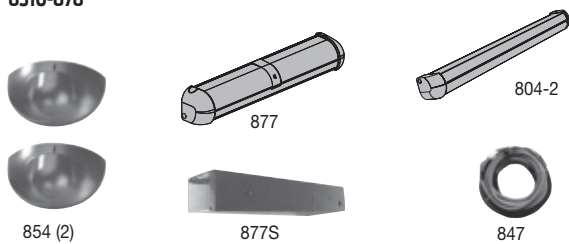

854 (2)

877

804-2

877S

847

8310-879

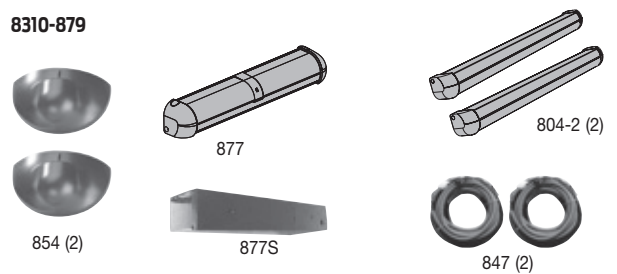

854 (2)

877

804-2 (2)

877S

847 (2)

ACTUATORS & ACCESSORIES

PRICE LIST

ACTUATORS & ACCESSORIES		LIST PRICE	PRODUCT DESCRIPTION
PRODUCT NUMBER	DESCRIPTION		



8310 Series Activation/Safety Sensor Accessories

8310-805	Switch, Door Position	\$57	Switch, Door Position, Surface Mount. Used when 8310-804-1 Surface Mount or 8310-804-2 Door Mounted Safety Sensor is installed in conjunction w/ either a 4630 or 4640 Series Automatic Operator. Disables approach side sensor when door is closed		8310-824
8310-805C	Switch, Door Position	57	Switch, Door Position, Concealed. Used when 8310-804-1 Concealed or 8310-804-2 Door Mounted Safety Sensor is installed in conjunction w/ either a 4630 or 4640 Series Automatic Operator. Disables approach side sensor when door is closed		8310-859
8310-824	Transformer	83	Transformer, 24v, Hardwired. Optional accessory - Used to remotely power any 24v sensor/receiver		8310-854ECA
8310-824P	Transformer	83	Transformer, 24v, Plug In. Optional accessory - Used to remotely power any 24v sensor/receiver		8310-854ERA
8310-846	Harness, Header Mount	29	Harness, Header Mount. Used w/ 8310-877 Header Mount Safety Sensor		8310-854ERA
8310-847	Harness, Door Mount	116	Harness, Door Mount. Used w/ 8310-804-1 or 8310-804-2 Door Mount Safety Sensor		8310-854ERA
8310-854ECA	Bracket, Drop Ceiling	208	Bracket, Drop Ceiling. Optional bracket used w/ 8310-854 Header Mount Activation Sensor		8310-854ERA
8310-854ERA	Cover, Protective	141	Cover, Protective Optional cover used w/ 8310-854 Header Mount Activation Sensor		8310-854ERA
8310-859	Remote, Handheld	178	Remote Control, Handheld. Optional handheld remote that can be used to program 8310-877 Header Mount Safety Sensor or 8310-854 Header Mount Motion Sensor		8310-854ERA
8310-877S	Spacer, Header Mount	166	Header Mount Safety Sensor Spacer. Required when 8310-804-1 or 8310-804-2 Door Mount Safety Sensors		8310-854ERA
8310-3803	Conversion Kit, Wireless, Jamb Mount	587	Wireless Conversion Kit, Jamb Mount, 3v Converts standard jamb actuator to wireless version Requires 8310-819 Jamb Box - Includes 8310-865 Receiver, 8310-844J (2) Jamb Mounted Transmitter Kit		8310-854ERA
8310-3809	Conversion Kit, Wireless, Wall Mount	587	Wireless Conversion Kit, Wall Mount, 9v Converts standard wall mount actuator to wireless version. Requires Surface Box & Weather Ring - Includes 8310-865 Receiver, 8310-844 (2) Wall Mount Transmitter Kit		8310-854ERA
8310-3888	Harness, Safety Module	37	Harness, Safety Module, Service Part. Safety Module Harness included in 8310-3889 Safety Module & Kit		8310-854ERA
8310-3889	Safety Module Kit	524	Safety Module & Kit Used w/ 7901, 7902, 7981, 7982 Control Boxes. Includes 8310-3888 Safety Module Harness, 8310-845 Time Delay Relay. Required when 8310-877 Header Mount Safety Sensor is used w/ Pneumatic Automatic Operators (2610, 4810, 4820 or 4840 Series)		8310-854ERA

8310 Series Activation/Safety Sensor Packages



8310-805



8310-805C



8310-824

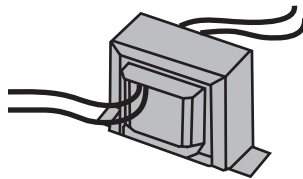

8310-824P

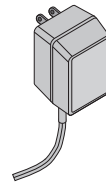

8310-846



8310-847



8310-854ECA

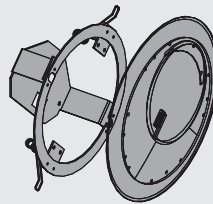

8310-854ERA

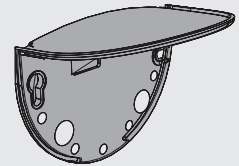

8310-859

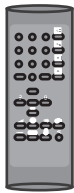

8310-8775



8310-3888



8310-3889



8310-3803

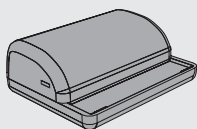

865

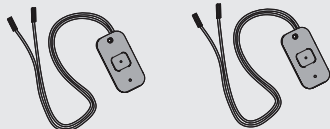

844J (2)

8310-3809

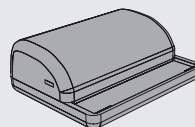

865

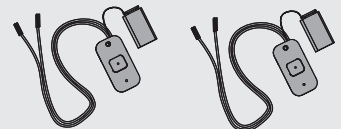

844 (2)

ACTUATORS & ACCESSORIES

PRICE LIST

ACTUATORS & ACCESSORIES		LIST PRICE	PRODUCT DESCRIPTION	
PRODUCT NUMBER	DESCRIPTION			

8310 Series Actuators, Sensors & Accessories

8310-844	Transmitter Kit, Wall Mount	\$202	Transmitter, Wireless, 1 Channel, Wall Mount, 9v Used to convert standard wall mount actuator to wireless. Requires 8310-865 Receiver
8310-844J	Transmitter Kit, Jamb Mount	202	Transmitter, Wireless, 1 Channel, Jamb Mount, 3v Used to convert standard jamb mount actuator to wireless. Requires 8310-865 Receiver
8310-861	Transmitter, Handheld	202	Transmitter, Wireless, 1 Channel, Handheld, 9v Requires 8310-865 Receiver
8310-862	Transmitter, Handheld	202	Transmitter, Wireless, 2 Channel, Handheld, 9v Requires at least one 8310-865 Receiver
8310-863	Transmitter, Handheld	202	Transmitter, Wireless, 3 Channel, Handheld, 9v Requires at least one 8310-865 Receiver
8310-864	Transmitter, Handheld	202	Transmitter, Wireless, 4 Channel, Handheld, 9v Requires at least one 8310-865 Receiver
8310-865	Receiver	212	Receiver, Wireless, 1 Channel, Sequencing Feature Used in conjunction w/ Wireless Actuators & Transmitters

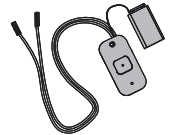

8310-844



8310-861

8310 Series Actuators, Sensors & Accessories

8310-866	Post, Bollard	\$930	42" x 4" x 6" Bollard Post, Mounting Base, Actuator Cut-Out Requires 8310-3853WB Bollard Actuator or 8310-3853TWB Bollard Actuator. Can be used w/ 8310-853 Wall Mount Actuator, 8310-853T Wall Mount Actuator or 8310-855 Wall Mount Actuator. Includes 8310-866CAP. Available in AL or DKBRZ (please specify).
8310-866FLA	Post, Bollard	930	42" x 4" x 6" Bollard Post, Mounting Base, Full Length Actuator Only Requires 8310-836T Full Length Actuator or 8310-836TW Full Length Actuator. Includes 8310-866CAP. Available in AL or DKBRZ (please specify).
8310-866CAP	Cap	152	Plastic Cap, Protective Cover, Service Part. Formed plastic cap for 8310-866 Bollard Post
8310-3853WB	Actuator, Bollard	439	4-3/4" Square w/ Logo, Wireless. For use w/ 8310 866 Bollard Post. Includes 8310-853 Actuator, 8310-844 Transmitter Kit. Requires 8310-865 Receiver.
8310-3853TWB	Actuator, Bollard	439	4-3/4" Square w/ Logo, Text, Wireless. For use w/ 8310-866 Bollard Post. Includes 8310-853T Actuator, 8310-844 Transmitter Kit. Requires 8310-865 Receiver.
8310-3836T	Actuator, Full Length	1,843	Actuator, 36" x 6" Full Length, Logo, Text Bollard Post Available In AL or DKBRZ (Please Specify). Includes 8310-866FLA Bollard Post and 8310-836T Full Length Actuator.
8310-3836TW	Actuator, Full Length	2,023	Actuator, 36" x 6" Full Length, Logo, Text, Wireless Includes 8310-844J. Requires 8310-865 Bollard Post Available In AL or DKBRZ (Please Specify). Includes 8310-866FLA Bollard Post, 8310-836T Full Length Actuator and 8310-844 Wireless Transmitter Kit.
8310-865	Receiver	212	Receiver, Wireless, 1 Channel, Sequencing Feature Used in conjunction w/ Wireless Actuators & Transmitters

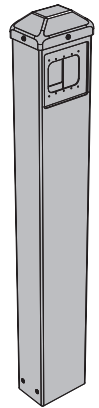

8310-866

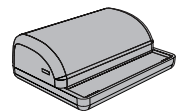

8310-865

8310 Series Actuators, Sensors & Accessories



8310-844

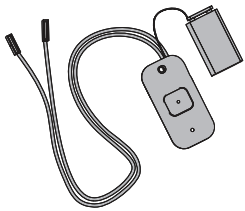

8310-844J

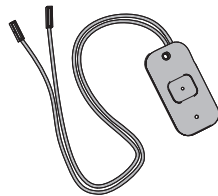

8310-865

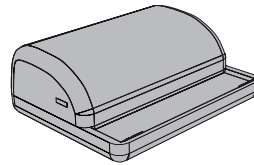

8310-866CAP

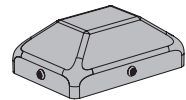

8310-3853WB

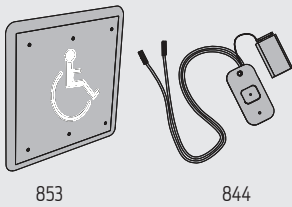

853

844

8310-866

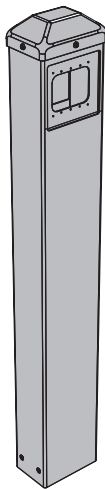

8310-866FLA

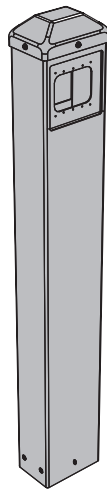

8310-3836T

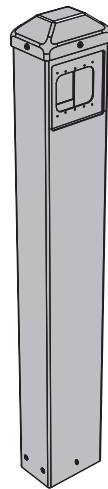

866FLA



836T

8310-3836TW

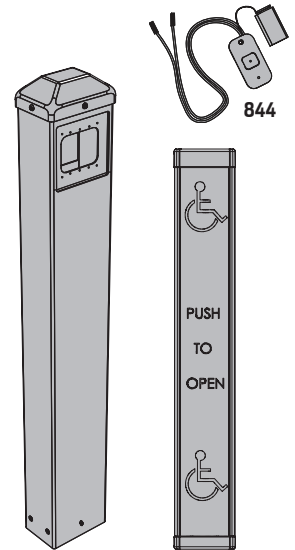

844

866FLA

836TW

8310-3853TWB

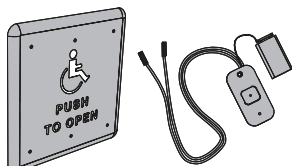

853T

844

8310-861

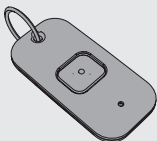

8310-862

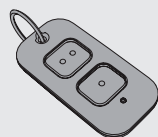

8310-863

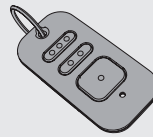

8310-864

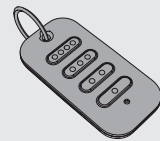

ACTUATORS & ACCESSORIES

PRICE LIST

ACTUATORS & ACCESSORIES		LIST PRICE	PRODUCT DESCRIPTION
PRODUCT NUMBER	DESCRIPTION		



8310 Series Accessories

8310-806K	Switch, Key	\$215	Switch, Key Type, 3 Position (On/Off/Hold-Open) Optional switch used w/ Senior Swing, Benchmark, or 4630/4640 Operators with (CS) option
8310-806R	Switch, Rocker	215	Switch, Rocker Type, 3 Position (On/Off/Hold-Open) Optional switch w/ Senior Swing or Benchmark Operators.
8310-807	Filter, Line	215	Line Filter, AC, 120v. Optional filter used w/ Senior Operators to reduce 'line noise'.
8310-845	Relay and Door Sequencer	330	Programmable Relay and Door Sequencer Used to coordinate electric locking Programmable device release for Senior Swing, also functions as door sequencer. Operator manufactured prior to 9/06. Also, is a component to the 8310-8337 Low Energy Convenience Package

8310 Series Accessories



8310-806K



8310-806R

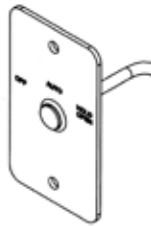

8310-807



8310-845



PARTS & ACCESSORIES

PRICE LIST

PARTS & ACCESSORIES	STANDARD POWDER COAT FINISHES	PLATED FINISHES		PARTS & ACCESSORIES	STANDARD POWDER COAT FINISHES	PLATED FINISHES		
	AL (689) DKBRZ (695) BRASS (696) LTBRZ (691) STAT (690) BLACK (693)				AL (689) DKBRZ (695) BRASS (696) LTBRZ (691) STAT (690) BLACK (693)	US26D	US 3 US 4 US 10	US 11 US 15 US 26

SEM7800 Series

SEM7810-E050.....Extension 1/2"	21.00
SEM7810-E075.....Extension 3/4"	28.00
SEM7810-E100.....Extension 1"	31.00
SEM7810-E200.....Extension 2"	37.00
SEM7810-E400.....Extension 4"	40.00
SEM7810-514.....Ball Pivot/Connection Link	31.00
SEM7820-515.....Fastener Kit	63.00
SEM7820-72.....Standard Cover & Base	474.00
SEM7820-825.....Door Armature	126.00
SEM7820-516.....Magnet Core Assembly	173.00
SEM7830-515.....Fastener Kit	23.00
SEM7830-72.....Standard Cover	95.00
SEM7830-268.....Surface Mount Box	35.00
SEM7830-516.....Magnet Core Assembly	159.00
SEM7830-825.....Door Armature	126.00
SEM7840-515.....Fastener Kit	23.00
SEM7840-72.....Standard Cover	95.00
SEM7840-516.....Magnet Core Assembly	159.00
SEM7840-825.....Door Armature	125.00
SEM7850-515.....Fastener Kit & Bracket	23.00
SEM7850-516.....Magnet Core Assembly	159.00
SEM7850-72.....Standard Cover	95.00
SEM7850-828.....Door Armature	181.00

1250 Series

1250-3071.....Std Cylinder Assy	135.00
1250-3077/PA.....Reg Arm w/62PA	70.00
1250-3077/62A.....Reg Arm w/62A	85.00
1250-3077L.....Long Arm	70.00
1250-3049/PA.....Hold Open Arm w/62PA	100.00
1250-3049L.....Hold Open Long Arm	100.00
1250-3077EDA.....EDA Arm	120.00
1250-3049EDA.....HEDA Arm	155.00
1250-3077CUSH.....CUSH Arm	155.00
1250-3049CUSH.....HCUSH Arm	215.00
1250-3077SCUSH.....S Cush Arm	215.00
1250-3049SCUSH.....Spring H Cush Arm	275.00
1250-UNIV.....Screw Pack	21.00
1250-TORX.....Screw Pack	36.00
1250-TBTRX.....Screw Pack	36.00
1250-72.....Slim Cover	15.00
1250-18.....Plate	42.00
1250-18PA.....Plate	42.00
1250-30.....Cush Shoe Support	21.00
1250-61.....Spacer	23.00
1250-62A.....Auxiliary Shoe	37.00
1250-62PA.....PA Shoe	14.00
1250-146.....Shaft Cover	4.00
1250-201.....Spacer	4.00
1250-419.....Panel Adapter	55.00
1250-3080.....Spring CUSH Block	55.00
1250-Flat Box.....Flat Box w/Label	4.00
1250-Instruction Sheet.....Instruction Sheet	3.00
1250-Rebox Kit.....Box & Instruction Sheet	5.00

1260 Series

1261-3071.....Std Cylinder Assy	192.00
1260-3077.....Reg Arm	82.00
1260-3077/PA.....Reg Arm w/62PA	88.00
1260-3077/62A.....Reg Arm w/62A	104.00
1260-3077L.....Long Arm	88.00

1260-3049.....Hold Open Arm	115.00
1260-3049/PA.....Hold Open Arm w/62PA	121.00
1260-3049L.....Hold Open Long Arm	121.00
1260-3077EDA.....EDA Arm	142.00
1260-3077EDA/G.....EDA Arm w/62G	148.00
1260-3049EDA.....HEDA Arm	175.00
1260-3049EDA/G.....HEDA Arm w/62G	181.00
1260-3077CUSH.....CUSH Arm	175.00
1260-3049CUSH.....HCUSH Arm	236.00
1260-72.....Slim Cover	16.00
1260-SRT.....Screw Pack	23.00
1260-TBSRT.....Screw Pack	23.00
1260-WMS.....Screw Pack	23.00
1260-TBWMS.....Screw Pack	23.00
1260-TORX.....Screw Pack	39.00
1260-TBTRX.....Screw Pack	39.00
1260-18.....Plate	46.00
1260-18PA.....Plate	46.00
1260-18QF.....Plate	46.00
1260-30.....Cush Shoe Support	23.00
1260-37.....Hold Open Stud	25.00
1260-41.....Hold Open Nut	6.00
1260-45.....Hold Open Shoe	23.00
1260-49.....Hold Open Main Arm	60.00
1260-61.....Spacer	25.00
1260-62A.....Auxiliary Shoe	39.00
1260-62PA.....PA Shoe	15.00
1260-77.....Arm & Forearm	80.00
1260-78H.....H Head & Tube	69.00
1260-78HL.....Head & Long Tube	74.00
1260-79.....Rod & Shoe	27.00
1260-79LR.....Long Rod & Shoe	29.00
1260-83.....Arm Screw	2.80
1260-83H.....H Arm Screw	2.80
1260-146.....Shaft Cover	4.40
1260-159.....Arm Screw	2.80
1260-201.....Spacer	4.40
1260-384.....Stop	21.00
1260-419.....Panel Adapter	61.00
1260-3048.....Head & Tube Assy	78.00
1260-3048L.....Head & Long Tube Assy	83.00
1260-Flat Box.....Flat Box w/Label	4.40
1260-Instruction Sheet.....Instruction Sheet	3.30
1260-Rebox Kit.....Box & Instruction Sheet	5.00

1450 Series

1450-3071.....Std Cylinder Assy	190.00	NA	NA
1450-3071DEL.....Del Action Cylinder Assy	230.00	NA	NA
1450-3077/PA.....Reg Arm w/62PA	70.00	NA	NA
1450-3077/62A.....Reg Arm w/62A	85.00	NA	NA
1450-3077L.....Long Arm	70.00	NA	NA
1450-3049/PA.....H Arm w/62PA	100.00	NA	NA
1450-3049L.....H Long Arm	100.00	NA	NA
1450-3077EDA.....EDA Arm	120.00	NA	NA
1450-3077EDA/G.....EDA Arm w/62G	125.00	NA	NA
1450-3049EDA.....H EDA Arm	155.00	NA	NA
1450-3077CNS.....Cush Arm	155.00	NA	NA
1450-3049CNS.....H Cush Arm	215.00	NA	NA
1450-3077SCNS.....S Cush Arm	215.00	NA	NA
1450-3049SCNS.....Spring H Cush Arm	275.00	NA	NA
1450-72.....Standard Cover	15.00	NA	NA
1450-72FC.....Full Plastic Cover	25.00	NA	NA

1450 Series continued on next page

PARTS & ACCESSORIES

PRICE LIST

PARTS & ACCESSORIES	STANDARD POWDER COAT FINISHES <i>AL (689) DKBRZ (695) BRASS (696) LTBRZ (691) STAT (690) BLACK (693)</i>	PLATED FINISHES			PARTS & ACCESSORIES	STANDARD POWDER COAT FINISHES <i>AL (689) DKBRZ (695) BRASS (696) LTBRZ (691) STAT (690) BLACK (693)</i>	PLATED FINISHES		
		US26D	US 3 US 4 US 10	US 11 US 15 US 26			US26D	US 3 US 4 US 10	US 11 US 15 US 26
<i>1450 Series continued</i>									
1450-72MC.....Full Metal Cover	45.00	NA		NA	1460-41.....Hold Open Nut	6.00			
1450-72ALT.....Alternate Cover	25.00	NA		NA	1460-45.....Hold Open Shoe	23.00			
1450-UNIV.....Screw Pack	21.00	NA		NA	1460-49.....Hold Open Main Arm	60.00			
1450-TORX.....Screw Pack	36.00	NA		NA	1460-61.....Spacer	25.00	68.00		
1450-TBTRX.....Screw Pack	36.00	NA		NA	1460-62A.....Auxiliary Shoe	40.00	100.00		
1450-18.....Plate	54.00	NA		NA	1460-62PA.....PA Shoe	15.00	90.00		
1450-18FC.....Plate	54.00	NA		NA	1460-77.....Arm & Forearm	80.00			
1450-18PA.....Plate	54.00	NA		NA	1460-77HD.....Heavy Duty Arm & Forearm	110.00			
1450-18PAFC.....Plate	54.00	NA		NA	1460-78H.....H Head & Tube	69.00			
1450-30.....Cush Shoe Support	21.00	NA		NA	1460-78HL.....Head & Long Tube	74.00			
1450-31.....Cover Screw	2.50	NA		NA	1460-79.....Rod & Shoe	27.00	85.00		
1450-61.....Spacer	23.00	NA		NA	1460-79LR.....Long Rod & Shoe	28.00	92.00		
1450-62A.....Auxiliary Shoe	37.00	NA		NA	1460-83.....Arm Screw	2.80			
1450-62PA.....PA Shoe	14.00	NA		NA	1460-83H.....H Arm Screw	2.80			
1450-146.....Shaft Cover	4.00	NA		NA	1460-124.....Plug	2.80			
1450-419.....Panel Adapter	55.00	NA		NA	1460-146.....Shaft Cover	4.40			
1450-3080.....Spring Cush Block	55.00	NA		NA	1460-159.....Arm Screw	2.80			
1450-Flat Box.....Flat Box w/Label	4.00	NA		NA	1460-163.....Arm Insert	2.80			
1450-Instruction Sheet.....Instruction Sheet	3.00	NA		NA	1460-201.....Spacer	4.40			
1450-Rebox Kit.....Box & Instruction Sheet	5.00	NA		NA	1460-384.....Stop	21.00			
1460 Series									
1461-3071.....Std Cylinder Assy	252.00				1460-419.....Panel Adapter	61.00	156.00		
1461-3071DEL.....Del Action Cylinder Assy	297.00				1460-3048.....Head & Tube Assy	78.00	158.00		
1460-3077.....Reg Arm	82.00	209.00	245.00		1460-3048L.....Head & Long Tube Assy	83.00	163.00		
1460-3077/PA.....Reg Arm w/62PA	88.00	266.00	318.00		1460-3080.....Spring Cush Block	61.00			
1460-3077/62A.....Reg Arm w/62A	104.00	284.00	333.00		1460-3373.....Adapter Kit	4.40			
1460-3077HD.....Heavy Duty Arm	115.00	240.00	284.00		1460-Flat Box.....Flat Box w/Label	4.40			
1460-3077HD/PA.....HD Arm w/62PA	121.00	303.00	340.00		1460-Instruction Sheet.....Instruction Sheet	3.30			
1460-3077HD/62A.....HD Arm w/62A	137.00	323.00	374.00		1460-Rebox Kit.....Box & Instruction Sheet	5.00			
1460-3077HD/L.....HD Long Arm	121.00	251.00	290.00		1460T Series				
1460-3077L.....Long Arm	88.00	213.00	251.00		1460T-3071.....Std Cylinder Assy	280.00			
1460-3049.....Hold Open Arm	115.00	240.00	284.00		1461T-3071.....Std Cylinder Assy	280.00			
1460-3049/PA.....H Arm w/62PA	121.00	303.00	340.00		1460T-3077T.....Standard Arm	82.00	202.00	240.00	
1460-3049L.....H Long Arm	121.00	303.00	340.00		1460T-3038.....Standard Track	61.00			
1460-3077EDA.....EDA Arm	142.00	350.00	390.00		1460T-3038B.....Track w/Bumper	71.00			
1460-3077EDA/G.....EDA Arm w/62G	148.00	356.00	394.00		1460T-3038H.....Track w/Hold Open	82.00			
1460-3049EDA.....H EDA Arm	175.00	383.00	426.00		1460T-3038HB.....Track w/Hold Open & Bumper	94.00			
1460-3049EDA/G.....H EDA Arm w/62G	181.00	394.00	422.00		1460T-72.....Standard Cover	16.00			
1460-3077CNS.....Cush Arm	175.00	383.00	426.00		1460T-72DS1.....Designer Series Cover	49.00	169.00	207.00	
1460-3049CNS.....H Cush Arm	236.00	432.00	482.00		1460T-72FC.....Full Cover	28.00			
1460-3077SCNS.....S Cush Arm	236.00	432.00	482.00		1460T-SRT.....Screw Pack (incl -3034)	50.00	72.00	85.00	
1460-3049SCNS.....Spring H Cush Arm	297.00	493.00	543.00		1460T-TBSRT.....Screw Pack (incl -3034)	50.00	72.00	85.00	
1460-72.....Standard Cover	16.00				1460T-WMS.....Screw Pack (incl -3034)	50.00	72.00	85.00	
1460-72DS1.....Designer Series Cover	49.00	169.00	207.00		1460T-TBWMS.....Screw Pack (incl -3034)	50.00	72.00	85.00	
1460-72FC.....Full Cover	28.00				1460T-TORX.....Screw Pack (incl -3034)	67.00	89.00	102.00	
1460-SRT.....Screw Pack	23.00	45.00	56.00		1460T-TBTRX.....Screw Pack (incl -3034)	67.00	89.00	102.00	
1460-TBSRT.....Screw Pack	23.00	45.00	56.00		1460T-HSRT.....HO Screw Pack (incl -3034H)	50.00	72.00	85.00	
1460-WMS.....Screw Pack	23.00	45.00	56.00		1460T-HTBSRT.....HO Screw Pack (incl -3034H)	50.00	72.00	85.00	
1460-TBWMS.....Screw Pack	23.00	45.00	56.00		1460T-HWMS.....HO Screw Pack (incl -3034H)	50.00	72.00	85.00	
1460-TORX.....Screw Pack	39.00	72.00	83.00		1460T-HTBWMS.....HO Screw Pack (incl -3034H)	50.00	72.00	85.00	
1460-TBTRX.....Screw Pack	39.00	72.00	83.00		1460T-HTORX.....HO Screw Pack (incl -3034H)	50.00	72.00	85.00	
1460-18.....Plate	60.00				1460T-HTBTRX.....HO Screw Pack (incl -3034H)	50.00	72.00	85.00	
1460-18DS.....Plate	60.00	203.00			1460T-18.....Plate	60.00			
1460-18FC.....Plate	60.00				1460T-18DS.....Plate	60.00	203.00		
1460-18PA.....Plate	60.00				1460T-18FC.....Plate	60.00			
1460-18PADS.....Plate	60.00	203.00			1460T-18GFC.....Plate	60.00			
1460-18PAFC.....Plate	60.00				1460T-18PA.....Plate	60.00			
1460-30.....Cush Shoe Support	23.00	66.00			1460T-18PADS.....Plate	60.00	203.00		
1460-30A.....Mounting Bracket	7.00				1460T-18PAFC.....Plate	60.00			
1460-37.....Hold Open Stud	25.00				1460T-30A.....Mounting Bracket	7.00			
					1460T-73.....End Cap	9.00			
					1460T-78.....Arm & Tube	71.00			

1460T Series continued on next page

PARTS & ACCESSORIES

PRICE LIST

PARTS & ACCESSORIES	STANDARD POWDER COAT FINISHES AL (689) DKBRZ (695) BRASS (696) LTBRZ (691) STAT (690) BLACK (693)	PLATED FINISHES			PARTS & ACCESSORIES	STANDARD POWDER COAT FINISHES ANCLR ANDKB	PLATED FINISHES		
		US26D	US 3 US 4 US 10	US 11 US 15 US 26			US26D	US 3 US 4 US 10	US 11 US 15 US 26
<i>1460T Series continued</i>									
1460T-82.....Rod	58.00				2030-3002..... Mounting/Finish Plate	147.00	286.00		
1460T-83H.....H Arm Screw	2.70				2030-3034..... Track Roller	28.00			
1460T-141-1.....Plug	2.70				2030-3034H..... Hold Open Track Roller	28.00			
1460T-141-2.....Plug	2.70				2030-3054..... Hold Open Clip	29.00			
1460T-146.....Shaft Cover	4.30				2030-SPL-3034..... P-1152 Roller	40.00			
1460T-159.....Arm Screw	2.70				2030-SPL-3038..... P-1224 Track	74.00			
1460T-163.....Arm Insert	2.70				2030-3064H.....HO Roller and Clip	56.00			
1460T-169.....Bumper Assy	20.00				2030-Flat Box.....Flat Box w/Label	4.40			
1460T-425.....Roller Lock Screw	4.30				2030-Instruction Sheet.....Instruction Sheet	3.30			
1460T-3034.....Track Roller	27.00				2030-Rebox Kit.....Box & Instruction Sheet	5.00			
1460T-3034H.....Hold Open Track Roller	27.00								
1460T-3054.....Hold Open Clip	28.00				2210 Series				
1460T-Flat Box.....Flat Box w/Label	4.30				2213(4,5)-3071.....Std Cylinder Assy	689.00			
1460T-Instruction Sheet.....Instruction Sheet	3.20				2213(4,5)-3071AVB.....AVB Cylinder Assy	711.00			
1460T-Rebox Kit.....Box & Instruction Sheet	5.00				2210-3077T.....Standard Arm	131.00	368.00	391.00	
					2210-72.....Finish Plate (11&12)				
2010 Series					2210-3038.....Standard Track	94.00			
2011(3,4,5,6)-3071.....Std Cylinder Assy	496.00				2210-TORX.....Screw Pack	39.00	72.00	83.00	
2010-3077T.....Standard Arm	104.00	284.00	328.00		2210-11.....Finish Plate	31.00	107.00		
2010-3038.....Standard Track	61.00				2210-12.....Short Finish Plate	29.00	104.00		
2010-3038B.....Track w/Bumper	71.00				2210-31.....Cover Screw	2.80			
2010-3038H.....Track w/Hold Open	82.00				2210-159.....Arm Screw	2.80			
2010-3038HB.....Track w/Hold Open & Bumper	94.00				2210-3034.....Track Roller	28.00			
2010-WMS.....Screw Pack (incl -3034)	50.00	72.00	85.00		2210-Flat Box.....Flat Box w/Label	4.40			
2010-TORX.....Screw Pack (incl -3034)	67.00	89.00	102.00		2210-Instruction Sheet.....Instruction Sheet	3.30			
2010-HWMS.....HO Screw Pack (incl -3034H)	50.00	72.00	85.00		2210-Rebox Kit.....Box & Instruction Sheet	5.00			
2010-HTORX.....HO Screw Pack (incl -3034H)	67.00	89.00	102.00						
2010-11.....Finish Plate	46.00	186.00			2210DPS Series				
2010-31.....Cover Screw	2.80				2213(4,5)DPS-3071.....Std Cylinder Assy	800.00	949.00	1,008.00	
2010-159.....Arm Screw	2.80				2213(4,5)DPS-3071AVB.....AVB Cylinder Assy	823.00	972.00	1,031.00	
2010-169.....Bumper Assy	21.00				2210DPS-3077T.....Standard Arm	131.00	368.00	391.00	
2010-420.....Fire Shield	61.00				2210DPS-72.....Finish Plate (11&12)	55.00	204.00	263.00	
2010-425.....Roller Lock Screw	4.40				2210DPS-3038.....Standard Track	94.00			
2010-3034.....Track Roller	28.00				2210DPS-TORX.....Screw Pack	39.00	72.00	83.00	
2010-3034H.....Hold Open Track Roller	28.00				2210DPS-11.....Finish Plate	31.00	107.00		
2010-3054.....Hold Open Clip	29.00				2210DPS-12.....Short Finish Plate	29.00	104.00		
2010-SPL-3034.....P-1152 Roller	40.00				2210DPS-31.....Cover Screw	2.80			
2010-SPL-3038.....P-1224 Track	74.00				2210DPS-159.....Arm Screw	2.80			
2010-3064H.....HO Roller and Clip	56.00				2210DPS-493.....DPS Test Kit	73.00			
2010-Flat Box.....Flat Box w/Label	4.40				2210DPS-3034.....Track Roller	28.00			
2010-Instruction Sheet.....Instruction Sheet	3.30				2210DPS-3340.....Wire Harness	73.00			
2010-Rebox Kit.....Box & Instruction Sheet	5.00				2210DPS-Flat Box.....Flat Box w/Label	4.40			
					2210DPS-Instruction Sheet.....Instruction Sheet	3.30			
					2210DPS-Rebox Kit.....Box & Instruction Sheet	5.00			
2030 Series					2310ME Series				
2031(2,3,4,5)-3071.....Std Cylinder Assy	929.00	1,189.00	1,277.00		2314ME-3071.....Std Cylinder Assy	1,069.00	1,218.00	1,277.00	
2031(2,3,4,5)-3971.....Cylinder Only	838.00				2314ME-3071B80.....B80 Cylinder Assy	1,157.00	1,306.00	1,365.00	
2030-3077T.....Standard Arm	110.00	301.00	351.00		2314ME-3071B140.....B140 Cylinder Assy	1,157.00	1,306.00	1,365.00	
2030-3038.....Standard Track	61.00				2314ME-3971.....Cylinder Only	1,069.00	1,218.00	1,277.00	
2030-3038B.....Track w/Bumper	71.00				2314ME-3971B80.....B80 Cylinder Only	1,048.00			
2030-3038H.....Track w/Hold Open	82.00				2314ME-3971B140.....B140 Cylinder Only	1,048.00			
2030-3038HB.....Track w/Hold Open & Bumper	94.00				2310ME-3077T.....Standard Arm	99.00	287.00	327.00	
2030-WMS.....Screw Pack (incl -3034)	50.00	72.00	85.00		2310ME-72.....Finish Plate (11&12)	55.00	204.00	263.00	
2030-TORX.....Screw Pack (incl -3034)	67.00	89.00	102.00		2310ME-3038.....Standard Track	61.00			
2030-HWMS.....HO Screw Pack (incl -3034H)	50.00	72.00	85.00		2310ME-WMS.....Screw Pack (incl -3034)	50.00	72.00	85.00	
2030-HTORX.....HO Screw Pack (incl -3034H)	67.00	89.00	102.00		2310ME-TORX.....Screw Pack (incl -3034)	67.00	89.00	102.00	
2030-159.....Arm Screw	2.80				2310ME-11.....Finish Plate	31.00	107.00		
2030-169.....Bumper Assy	21.00				2310ME-12.....Short Finish Plate	29.00	104.00		
2030-416.....Wood Clip Set	157.00	224.00			2310ME-31.....Cover Screw	2.80			
2030-417.....Wood Clip Set	157.00	224.00			2310ME-159.....Arm Screw	2.80			
2030-420.....Fire Shield	61.00				2310ME-172.....Wiring Cover	9.00			
2030-425.....Roller Lock Screw	4.40								

*Require length - please note when ordering

2310ME Series continued on next page

PARTS & ACCESSORIES

PRICE LIST

PARTS & ACCESSORIES	STANDARD POWDER COAT FINISHES	PLATED FINISHES			PARTS & ACCESSORIES	STANDARD POWDER COAT FINISHES	PLATED FINISHES		
	AL (689) DKBRZ (695) BRASS (696) LTBRZ (691) STAT (690) BLACK (693)	US26D	US 3 US 4 US 10	US 11 US 15 US 26		AL (689) DKBRZ (695) BRASS (696) LTBRZ (691) STAT (690) BLACK (693)	US26D	US 3 US 4 US 10	US 11 US 15 US 26

2310ME Series continued

2310ME-420.....Fire Shield	59.00			
2310ME-425.....Roller Lock Screw	4.30			
2310ME-3034.....Track Roller	27.00			
2310ME-3210.....Transformer	69.00			
2310ME-3431.....Input Jumper	6.00			
2310ME-3351.....ME Switch Assy	84.00			
2310ME-Flat Box.....Flat Box w/Label	4.30			
2310ME-Instruction Sheet.....Instruction Sheet	3.20			
2310ME-Rebox Kit.....Box & Instruction Sheet	5.00			

2610 Series

2613(4)-3071.....Std Cylinder Assy	2,049.00	2,261.00	2,319.00	
2613(4)-3071DPS.....DPS Cylinder Assy	2,261.00	2,473.00	2,532.00	
2613(4)-3971.....Cylinder Only	1,934.00			
2613(4)-3971DPS.....DPS Cylinder Only	2,145.00			
2610-3077T.....Standard Arm	107.00	297.00	356.00	
2610-3038.....Standard Track	61.00			
2610-WMS.....Screw Pack (incl -3034)	50.00	72.00	85.00	
2610-61.....Spacer	13.00			
2610-78.....Arm & Tube	71.00			
2610-82.....Rod	60.00			
2610-83H.....H Arm Screw	2.80			
2610-155-1.....Caution Decal	5.00			
2610-155-2.....Activation Decal	5.00			
2610-159.....Arm Screw	2.80			
2610-425.....Roller Lock Screw	4.40			
2610-3002.....Mounting/Finish Plate	147.00	286.00		
2610-3034.....Track Roller	28.00			
2610-Flat Box.....Flat Box w/Label	4.40			
2610-Instruction Sheet.....Instruction Sheet	3.30			
2610-Rebox Kit.....Box & Instruction Sheet	5.00			

2810 Series - (ANCLR or ANDKB only)

2810-3077CP.....Center Pivot Arm	258.00			
2810-3077OP.....Offset/Butt Hung Arm	214.00			
2810-3077OPCM*Offset Arm w/Track & Conc Channel	427.00			
2810-3572HL*.....Header Asy	345.00			
2810-3572HL/S*.....Header Asy w/Stop Prep	345.00			
2810-3572DD*.....Double Door Header Asy	587.00			
2810-3572DD/S*Double Door Header Asy w/Stop Prep	587.00			
2810-3572DD/MPDouble Door Header w/Manual Prep	1,245.00			
2810-MS.....Screw Pack	23.00			
2810-11A.....Spindle Plate - 2 3/4"	77.00			
2810-11B.....Spindle Plate - 3 3/4"	77.00			
2810-12*.....Blank Filler Plate	94.00			
2810-78.....Arm & Tube	204.00			
2810-82.....Rod	118.00			
2810-107.....Pivot Body	68.00			
2810-110.....Pivot Post	54.00			
2810-117.....Bottom Pivot Plate	54.00			
2810-168.....Slide	39.00			
2810-275.....Mounting Bracket - 2 3/4"	104.00			
2810-334.....Header Endcaps	45.00			
2810-334-2.....End Cap	77.00			
2810-375.....Mounting Bracket - 3 3/4"	103.00			
2810-384B.....Breakaway Door Stop	153.00			
2810-384F.....Fixed Door Stop	73.00			
2810-511*.....Dress Plate Extrusion Only	18.00 / ft			
2810-518.....Cable/Parts Bag	94.00			
2810-572*.....Header Extrusion Only	55.00 / ft			
2810-572HL*.....Header Only	221.00			

2810-572HL/S*.....Header Only w/Stop Prep	221.00
2810-572DD*.....Double Door Header Only	469.00
2810-572DD/S*Double Door Header Only w/Stop Prep	469.00
2810-3018.....Rear Mount Bracket	103.00
2810-3072*.....Concealing Channel	227.00
2810-3107.....Bottom Pivot Assembly	163.00
2810-3155.....Label Kit	28.00
2810-3454.....Motor Gearbox	2,304.00
2810-3462.....Controller	1,498.00

2850 Series - (ANCLR or ANDKB only)

2850-3077CP.....Center Pivot Arm	242.00
2850-3077OP.....Offset/Butt Hung Arm	201.00
2850-3077OPCM*Offset Arm w/Track & Conc Channel	427.00
2850-3572HL*.....Header Asy	587.00
2850-3572HL/S*.....Header Asy w/Stop Prep	587.00
2850-MS.....Screw Pack	23.00
2850-11A.....Spindle Plate - 2 3/4"	77.00
2850-11B.....Spindle Plate - 3 3/4"	77.00
2850-12*.....Blank Filler Plate	94.00
2850-78.....Arm & Tube	204.00
2850-82.....Rod	118.00
2850-107.....Pivot Body	68.00
2850-110.....Pivot Post	54.00
2850-117.....Bottom Pivot Plate	54.00
2850-168.....Slide	39.00
2850-275.....Mounting Bracket - 2 3/4"	104.00
2850-334.....Header Endcaps	45.00
2850-334-2.....End Cap	77.00
2850-375.....Mounting Bracket - 3 3/4"	103.00
2850-384B.....Breakaway Door Stop	153.00
2850-384F.....Fixed Door Stop	73.00
2850-511*.....Dress Plate Extrusion Only	18.00 / ft
2850-518.....Cable/Parts Bag	94.00
2850-572*.....Header Extrusion Only	55.00 / ft
2850-572HL*.....Header Only	469.00
2850-572HL/S*.....Header Only w/Stop Prep	469.00
2850-982.....Companion Cable	70.00
2850-3018.....Rear Mount Bracket	103.00
2810-3072MP.....Concealing Channel-Manual Prep	230.00
2850-3107.....Bottom Pivot Assembly	163.00
2850-3155.....Label Kit	28.00
2850-3454.....Motor Gearbox (Std Force)	2,304.00
2850-3462.....Controller	1,498.00

2860 Series - (ANCLR or ANDKB only)

2860-3077CP.....Center Pivot Arm	516.00
2860-3077OP.....Offset/Butt Hung Arm	427.00
2860-3077OPCM*Offset Arm w/Track & Conc Channel	427.00
2860-3572HL*.....Header Asy	587.00
2860-3572HL/S*.....Header Asy w/Stop Prep	587.00
2860-MS.....Screw Pack	23.00
2860-11A.....Spindle Plate - 2 3/4"	77.00
2860-11B.....Spindle Plate - 3 3/4"	77.00
2860-12*.....Blank Filler Plate	94.00
2860-78.....Arm & Tube	204.00
2860-82.....Rod	118.00
2860-107.....Pivot Body	68.00
2860-110.....Pivot Post	54.00
2860-117.....Bottom Pivot Plate	54.00
2860-168.....Slide	39.00
2860-275.....Mounting Bracket - 2 3/4"	104.00

*Require length - please note when ordering

2860 Series continued on next page

PARTS & ACCESSORIES

PRICE LIST

PARTS & ACCESSORIES	STANDARD POWDER COAT FINISHES	PLATED FINISHES			PARTS & ACCESSORIES	STANDARD POWDER COAT FINISHES	PLATED FINISHES		
	AL (689) DKBRZ (695) BRASS (696) LTBRZ (691) STAT (690) BLACK (693)	US26D	US 3 US 4 US 10	US 11 US 15 US 26		AL (689) DKBRZ (695) BRASS (696) LTBRZ (691) STAT (690) BLACK (693)	US26D	US 3 US 4 US 10	US 11 US 15 US 26

2860 Series continued

2860-334.....Header Endcaps	44.00
2860-334-2.....End Cap	75.00
2860-375.....Mounting Bracket - 3 3/4"	100.00
2860-384B.....Breakaway Door Stop	149.00
2860-384F.....Fixed Door Stop	71.00
2860-511*.....Dress Plate Extrusion Only	17.00 / ft
2860-518.....Cable/Parts Bag	91.00
2860-572*.....Header Extrusion Only	53.00 / ft
2860-572HL*.....Header Only	455.00
2860-572HL/S*.....Header Only w/Stop Prep	455.00
2860-3018.....Rear Mount Bracket	100.00
2860-3107.....Bottom Pivot Assembly	158.00
2860-3155.....Label Kit	27.00
2860-3454.....Motor Gearbox (Std Force)	2,237.00
2860-3462.....Control Box	1,454.00

3030 Series

3031(2,3,4)-3071.....Std Cylinder Assy	353.00
3030-3077.....Reg Arm	121.00
3030-3049.....Hold Open Arm	153.00
3030-WMS.....Screw Pack	23.00
3030-TORX.....Screw Pack	39.00
3030-37.....Hold Open Stud	25.00
3030-41.....Hold Open Nut	6.00
3030-48.....Hold Open Forearm	67.00
3030-49.....Hold Open Main Arm	60.00
3030-77.....Arm & Forearm	80.00
3030-79.....Rod & Shoe	27.00
3030-79H.....H Rod & Shoe	28.00
3030-83.....Arm Screw	2.80
3030-83H.....H Arm Screw	2.80
3030-159.....Arm Screw	2.80
3030-421.....Arm Stud	9.00
3030-Flat Box.....Flat Box w/Label	4.40
3030-Instruction Sheet.....Instruction Sheet	3.30
3030-Rebox Kit.....Box, Inst., & Screw Pk	5.00

3130 Series

3131(2,3)-3071.....Std Cylinder Assy	381.00
3130-3077T.....Standard Arm	113.00
3130-3038.....Standard Track	61.00
3130-3038B.....Track w/Bumper	71.00
3130-3038H.....Track w/Hold Open	82.00
3130-3038HB.....Track w/Hold Open & Bumper	94.00
3130-WMS.....Screw Pack (incl -3034)	50.00
3130-TORX.....Screw Pack (incl -3034)	67.00
3130-HWMS.....HO Screw Pack (incl -3034H)	50.00
3130-HTORX.....HO Screw Pack (incl -3034H)	67.00
3130-2.....Channel	10.00
3130-159.....Arm Screw	2.80
3130-169.....Bumper Assy	21.00
3130-425.....Roller Lock Screw	4.40
3130-3034.....Track Roller	28.00
3130-3034H.....Hold Open Track Roller	28.00
3130-3054.....Hold Open Clip	29.00
3130-Flat Box.....Flat Box w/Label	4.40
3130-Instruction Sheet.....Instruction Sheet	3.30
3130-Rebox Kit.....Box & Instruction Sheet	5.00

3130SE Series

3133(4)SE-3071.....Std Cylinder Assy	353.00
3130SE-3077T.....Standard Arm	113.00
3130SE-3077L.....Long Arm	118.00
3130SE-3038.....Standard Track	376.00
3130SEL-3038SEL.....Long Track	376.00
3130SE-WMS.....Screw Pack (incl. -81)	23.00
3130SE-TORX.....Screw Pack (incl. -81)	39.00
3130SE-59A.....Cover Plate	5.00
3130SE-60.....Cover Plate Screw	2.80
3130SE-73.....End Cap	9.00
3130SE-78.....Arm & Tube	71.00
3130SE-81.....Connector w/Ring	5.00
3130SE-82.....Rod	60.00
3130SE-83H.....H Arm Screw	2.80
3130SE-159.....Arm Screw	2.80
3130SE-3034SE.....Track Roller with Slider	33.00
3130SE-425.....Roller Lock Screw	4.40
3130SE-3210.....Transformer	71.00
3130SE-3436.....On/off Switch Assy	72.00
3130SE-Flat Box.....Flat Box w/Label	4.40
3130SE-Instruction Sheet.....Instruction Sheet	3.30
3130SE-Rebox Kit.....Box & Instruction Sheet	5.00

4000T Series

4003(4)T-3071.....Std Cylinder Assy	359.00
4000T-3077T.....Standard Arm	104.00
4000T-3038.....Standard Track	61.00
4000T-72.....Standard Cover	28.00
4000T-72MC.....Metal Cover	38.00
4000T-WMS.....Screw Pack (incl -3034)	50.00
4000T-TBWMS.....Screw Pack (incl -3034)	50.00
4000T-TORX.....Screw Pack (incl -3034)	67.00
4000T-TBTRX.....Screw Pack (incl -3034)	67.00
4000T-31.....Cover Screw	2.80
4000T-61.....Spacer	13.00
4000T-73.....End Cap	9.00
4000T-141-2.....Plug	2.80
4000T-159.....Arm Screw	2.80
4000T-425.....Roller Lock Screw	4.40
4000T-3034.....Track Roller	28.00
4000T-Flat Box.....Flat Box w/Label	4.40
4000T-Instruction Sheet.....Instruction Sheet	3.30
4000T-Rebox Kit.....Box & Instruction Sheet	5.00

4010 Series

4011(6)-3071.....Std Cylinder Assy	333.00
4011-3071DEL.....Del Act Cyl Assy	376.00
4011(6)-3071TEL.....TEL Cylinder Assy	376.00
4010-3077.....Reg Arm	129.00
4010-3049.....Hold Open Arm	156.00
4010-3049FL.....FL Arm	264.00
4010-72.....Standard Cover	28.00
4010-72MC.....Metal Cover	38.00
4010-SRT.....Screw Pack	23.00
4010-TBSRT.....Screw Pack	23.00
4010-WMS.....Screw Pack	23.00
4010-TBWMS.....Screw Pack	23.00
4010-TORX.....Screw Pack	39.00
4010-TBTRX.....Screw Pack	39.00
4010-18.....Plate	60.00
4010-28.....Fusible Link	11.00

4010 Series continued on next page

PARTS & ACCESSORIES

PRICE LIST

PARTS & ACCESSORIES	STANDARD POWDER COAT FINISHES	PLATED FINISHES			PARTS & ACCESSORIES	STANDARD POWDER COAT FINISHES	PLATED FINISHES		
	AL (689) DKBRZ (695) BRASS (696) LTBRZ (691) STAT (690) BLACK (693)	US26D	US 3 US 4 US 10	US 11 US 15 US 26		AL (689) DKBRZ (695) BRASS (696) LTBRZ (691) STAT (690) BLACK (693)	US26D	US 3 US 4 US 10	US 11 US 15 US 26

4010 Series continued

4010-31.....	Cover Screw	2.80		
4010-37.....	Hold Open Stud	25.00		
4010-37FL.....	FL Hold Open Stud	25.00		
4010-41.....	Hold Open Nut	6.00		
4010-48.....	Hold Open Forearm	67.00		
4010-49.....	Hold Open Main Arm	63.00		
4010-49FL.....	FL Main Arm & Rod	63.00		
4010-77.....	Arm & Forearm	117.00		
4010-79.....	Rod & Shoe	28.00	89.00	
4010-79H.....	H Rod & Shoe	28.00		
4010-79LR.....	Long Rod & Shoe	28.00	89.00	
4010-83.....	Arm Screw	2.80		
4010-83H.....	H Arm Screw	2.80		
4010-95.....	Arm Stud	13.00		
4010-107 REG.....	Metal Template	264.00		
4010-159.....	Arm Screw	2.80		
4010-Flat Box.....	Flat Box w/Label	4.40		
4010-Instruction Sheet.....	Instruction Sheet	3.30		
4010-Rebox Kit.....	Box & Instruction Sheet	5.00		

4010T Series

4011(3,4)T-3071.....	Std Cylinder Assy	349.00		
4010T-3077T.....	Standard Arm	95.00	223.00	263.00
4010T-3077DE.....	DE Arm	140.00	268.00	308.00
4010T-3038.....	Standard Track	59.00		
4010T-3038B.....	Track w/Bumper	69.00		
4010T-3038H.....	Track w/Hold Open	80.00		
4010T-3038HB.....	Track w/Hold Open & Bumper	91.00		
4010T-72.....	Standard Cover	27.00		
4010T-72MC.....	Metal Cover	37.00	202.00	250.00
4010T-SRT.....	Screw Pack (incl -3034)	49.00	71.00	83.00
4010T-TBSRT.....	Screw Pack (incl -3034)	49.00	71.00	83.00
4010T-WMS.....	Screw Pack (incl -3034)	49.00	71.00	83.00
4010T-TBWMS.....	Screw Pack (incl -3034)	49.00	71.00	83.00
4010T-TORX.....	Screw Pack (incl -3034)	65.00	87.00	99.00
4010T-TBTRX.....	Screw Pack (incl -3034)	65.00	87.00	99.00
4010T-HSRT.....	HO Screw Pack (incl -3034H)	49.00	71.00	83.00
4010T-HTBSRT.....	HO Screw Pack (incl -3034H)	49.00	71.00	83.00
4010T-HWMS.....	HO Screw Pack (incl -3034H)	49.00	71.00	83.00
4010T-HTBWMS.....	HO Screw Pack (incl -3034H)	49.00	71.00	83.00
4010T-HTORX.....	HO Screw Pack (incl -3034H)	65.00	87.00	99.00
4010T-HTBTRX.....	HO Screw Pack (incl -3034H)	65.00	87.00	99.00
4010T-18.....	Plate	58.00	197.00	237.00
4010T-31.....	Cover Screw	2.70		
4010T-73.....	End Cap	9.00		
4010T-78DE.....	Main Arm & Tube	96.00		
4010T-82.....	Rod	58.00		
4010T-83H.....	H Arm Screw	2.70		
4010T-141-2.....	Plug	2.70		
4010T-159.....	Arm Screw	2.70		
4010T-169.....	Bumper Assy	20.00		
4010T-425.....	Roller Lock Screw	4.30		
4010T-3034.....	Track Roller	27.00		
4010T-3034H.....	HO Track Roller	27.00		
4010T-3054.....	Hold Open Clip	28.00		
4010T-3064H.....	Hold open Clip and Roller	54.00		
4010T-Flat Box.....	Flat Box w/Label	4.30		
4010T-Instruction Sheet.....	Instruction Sheet	3.20		
4010T-Rebox Kit.....	Box & Instruction Sheet	5.00		

4020 Series

4021(6)-3071.....	Std Cylinder Assy	333.00		
4021-3071DEL.....	Del Act Cyl Assy	376.00		
4021(6)-3071TEL.....	TEL Cylinder Assy	376.00		
4020-3077.....	Reg Arm	129.00	373.00	474.00
4020-3077L.....	Long Arm	134.00	383.00	482.00
4020-3049.....	Hold Open Arm	156.00	405.00	504.00
4020-3049FL.....	FL Arm	264.00		
4020-72.....	Standard Cover	28.00		
4020-72MC.....	Metal Cover	38.00	207.00	257.00
4020-SRT.....	Screw Pack	23.00	45.00	56.00
4020-TBSRT.....	Screw Pack	23.00	45.00	56.00
4020-WMS.....	Screw Pack	23.00	45.00	56.00
4020-TBWMS.....	Screw Pack	23.00	45.00	56.00
4020-TORX.....	Screw Pack	39.00	72.00	83.00
4020-TBTRX.....	Screw Pack	39.00	72.00	83.00
4020-18.....	Plate	60.00	203.00	
4020-18G.....	Plate	60.00	203.00	
4020-28.....	Fusible Link	11.00		
4020-31.....	Cover Screw	2.80		
4020-37.....	Hold Open Stud	25.00		
4020-37FL.....	FL Hold Open Stud	25.00		
4020-41.....	Hold Open Nut	6.00		
4020-48.....	Hold Open Forearm	67.00		
4020-49.....	Hold Open Main Arm	63.00		
4020-49FL.....	FL Main Arm & Rod	63.00		
4020-77.....	Arm & Forearm	117.00		
4020-79.....	Rod & Shoe	28.00	89.00	
4020-79H.....	H Rod & Shoe	28.00	89.00	
4020-79LR.....	Long Rod & Shoe	28.00	89.00	
4020-83.....	Arm Screw	2.80		
4020-83H.....	H Arm Screw	2.80		
4020-159.....	Arm Screw	2.80		
4020-Flat Box.....	Flat Box w/Label	4.40		
4020-Instruction Sheet.....	Instruction Sheet	3.30		
4020-Rebox Kit.....	Box & Instruction Sheet	5.00		

4020T Series

4021(3,4)T-3071.....	Std Cylinder Assy	359.00		
4020T-3077T.....	Standard Arm	98.00	229.00	271.00
4020T-3038.....	Standard Track	61.00		
4020T-3038B.....	Track w/Bumper	71.00		
4020T-3038H.....	Track w/Hold Open	82.00		
4020T-3038HB.....	Track w/Hold Open & Bumper	94.00		
4020T-72.....	Standard Cover	28.00		
4020T-72MC.....	Metal Cover	38.00	207.00	257.00
4020T-SRT.....	Screw Pack (incl -3034)	50.00	72.00	85.00
4020T-TBSRT.....	Screw Pack (incl -3034)	50.00	72.00	85.00
4020T-WMS.....	Screw Pack (incl -3034)	50.00	72.00	85.00
4020T-TBWMS.....	Screw Pack (incl -3034)	50.00	72.00	85.00
4020T-TORX.....	Screw Pack (incl -3034)	67.00	89.00	102.00
4020T-TBTRX.....	Screw Pack (incl -3034)	67.00	89.00	102.00
4020T-HSRT.....	HO Screw Pack (incl -3034H)	50.00	72.00	85.00
4020T-HTBSRT.....	HO Screw Pack (incl -3034H)	50.00	72.00	85.00
4020T-HWMS.....	HO Screw Pack (incl -3034H)	50.00	72.00	85.00
4020T-HTBWMS.....	HO Screw Pack (incl -3034H)	50.00	72.00	85.00
4020T-HTORX.....	HO Screw Pack (incl -3034H)	67.00	89.00	102.00
4020T-HTBTRX.....	HO Screw Pack (incl -3034H)	67.00	89.00	102.00
4020T-18.....	Plate	60.00	203.00	
4020T-31.....	Cover Screw	2.80		
4020T-73.....	End Cap	9.00		
4020T-141-2.....	Plug	2.80		

4020T Series continued on next page

PARTS & ACCESSORIES

PRICE LIST

PARTS & ACCESSORIES	STANDARD POWDER COAT FINISHES	PLATED FINISHES			PARTS & ACCESSORIES	STANDARD POWDER COAT FINISHES	PLATED FINISHES			
	AL (689) DKBRZ (695) BRASS (696) LTBRZ (691) STAT (690) BLACK (693)	US26D	US 3 US 4 US 10	US 11 US 15 US 26		AL (689) DKBRZ (695) BRASS (696) LTBRZ (691) STAT (690) BLACK (693)	US26D	US 3 US 4 US 10	US 11 US 15 US 26	
<i>4020T Series continued</i>										
4020T-159.....Arm Screw	2.80				4030T-TBWMS.....Screw Pack	23.00			45.00	56.00
4020T-169.....Bumper Assy	21.00				4030T-73.....End Cup	23.00			45.00	56.00
4020T-425.....Roller Lock Screw	4.40				4030T-141-1.....Plug	2.80				
4020T-3034.....Track Roller	28.00				4030T-141-2.....Plug	2.80				
4020T-3034H.....Hold Open Track Roller	28.00				4030T-159.....Arm Screw	2.80				
4020T-3054.....Hold Open Clip	29.00				4030T-425.....Roller Lock Screw	4.40				
4020T-3064H.....HO Roller and Clip	56.00				4030T-3054.....Hold Open Clip	29.00				
4020T-Flat Box.....Flat Box w/Label	4.40				4030T-Flat Box.....Flat Box w/Label	4.40				
4020T-Instruction Sheet.....Instruction Sheet	3.30				4030T-Instruction Sheet.....Instruction Sheet	3.30				
4020T-Rebox Kit.....Box & Instruction Sheet	5.00				4030T-Rebox Kit.....Box & Instruction Sheet	5.00				
4030 Series										
4031-3071.....Std Cylinder Assy	279.00				4040XP Series					
4030-3077.....Reg Arm	112.00		333.00		4040XP-3071.....Std Cylinder Assy	345.00				
4030-3077/PA.....Reg Arm w/62PA	117.00	266.00	411.00		4041-3071DEL.....Std Cylinder Assy	388.00				
4030-3077/62A.....Reg Arm w/62A	134.00	344.00	428.00		4040XP-3077.....Reg Arm	134.00		404.00		507.00
4030-3077LD.....Light Duty Arm	89.00	224.00	273.00		4040XP-3077/PA.....Reg Arm w/62PA	139.00		464.00		580.00
4030-3077LD/PA.....Light Duty Arm w/PA	95.00	284.00	351.00		4040XP-3077/62A.....Reg Arm w/62A	162.00		483.00		600.00
4030-3077LD/62A.....Light Duty Arm w/62A	111.00	303.00	370.00		4040XP-3077L.....Long Arm	139.00		410.00		514.00
4030-3077L.....Long Arm	117.00	271.00	340.00		4040XP-3077XL.....XL Reg Arm	172.00		443.00		541.00
4030-3049.....H Arm	145.00	290.00	356.00		4040XP-3049.....Hold Open Arm	195.00		448.00		554.00
4030-3049/PA.....H Arm w/62PA	150.00	349.00	427.00		4040XP-3049/PA.....H Arm w/62PA	200.00		517.00		643.00
4030-3049/L.....H Long Arm	150.00	295.00	361.00		4040XP-3049L.....H Long Arm	200.00		455.00		558.00
4030-3077EDA.....EDA Arm	150.00	379.00	431.00		4040XP-3077EDA.....EDA Arm	183.00		438.00		542.00
4030-3049EDA.....H EDA Arm	183.00	408.00	461.00		4040XP-3077EDA/G.....EDA Arm w/62G	188.00		443.00		547.00
4030-3077CNS.....Cush Arm	183.00	408.00	461.00		4040XP-3049EDA.....H EDA Arm	216.00		471.00		569.00
4030-3049CNS.....HCush Arm	243.00	490.00	519.00		4040XP-3049EDA/G.....H EDA Arm w/62G	221.00		476.00		574.00
4030-3077SCNS.....SCush Arm	243.00	490.00	519.00		4040XP-3077CNS.....Cush Arm	216.00		476.00		575.00
4030-3049SCNS.....Spring HCush Arm	304.00	548.00	576.00		4040XP-3049CNS.....H Cush Arm	271.00		536.00		635.00
4030-72MC.....Metal Cover	28.00	197.00	241.00		4040XP-3077SCNS.....S Cush Arm	271.00		536.00		635.00
4030-WMS.....Screw Pack	23.00	45.00	56.00		4040XP-3049SCNS.....Spring H Cush Arm	325.00		590.00		689.00
4030-TBWMS.....Screw Pack	23.00	45.00	56.00		4040XP-72.....Standard Cover	28.00				
4030-18PA.....Plate	60.00	203.00			4040XP-72MC.....Metal Cover	38.00		207.00		257.00
4030-18TJ.....Plate	60.00	203.00			4040XP-SRT.....Screw Pack	23.00		45.00		56.00
4030-30.....Cush Shoe Support	23.00	66.00			4040XP-TBSRT.....Screw Pack	23.00		45.00		56.00
4030-31.....Cover Screw	2.80				4040XP-WMS.....Screw Pack	23.00		45.00		56.00
4030-61.....Spacer	25.00	68.00			4040XP-TBWMS.....Screw Pack	23.00		45.00		56.00
4030-62A.....Auxiliary Shoe	40.00	100.00			4040XP-TORX.....Screw Pack	39.00		72.00		83.00
4030-62PA.....PA Shoe	15.00	90.00			4040XP-TBTRX.....Screw Pack	39.00		72.00		83.00
4030-77.....Arm & Forearm	80.00				4040XP-18.....Plate	60.00		203.00		
4030-79.....Rod & Shoe	28.00	89.00			4040XP-18G.....Plate	60.00		203.00		
4030-79LR.....Long Rod & Shoe	28.00	89.00			4040XP-18PA.....Plate	60.00		203.00		
4030-83.....Arm Screw	2.80				4040XP-18TJ.....Plate	60.00		203.00		
4030-83H.....H Arm Screw	2.80				4040XP-30.....Cush Shoe Support	23.00		66.00		
4030-159.....Arm Screw	2.80				4040XP-31.....Cover Screw	2.80				
4030-201.....Spacer	4.40				4040XP-37.....Hold Open Stud	25.00				
4030-419.....Panel Adapter	61.00	156.00			4040XP-37EDA.....EDA Hold Open Stud	25.00				
4030-3045.....Hold Open Shoe	20.00				4040XP-41.....Hold Open Nut	6.00				
4030-3048.....Head & Tube Assy	78.00	158.00			4040XP-45.....Hold Open Shoe	23.00				
4030-3080.....Spring Cush Block	61.00				4040XP-48.....Hold Open Forearm	67.00				
4030-Flat Box.....Flat Box w/Label	4.40				4040XP-49.....Hold Open Main Arm	63.00				
4030-Instruction Sheet.....Instruction Sheet	3.30				4040XP-54.....Snap-On Cover Clip Only	10.00				
4030-Rebox Kit.....Box & Instruction Sheet	5.00				4040XP-58.....Spring & Screw (used with -80)	11.00				
4030T Series										
4031T-3071.....Std Cylinder Assy	279.00				4040XP-61.....Spacer	25.00		68.00		
4030T-3077T.....Standard Arm (includes 3034)	121.00	257.00	301.00		4040XP-62A.....Auxiliary Shoe	40.00		100.00		
4030T-3038.....Standard Track	61.00				4040XP-62PA.....PA Shoe	15.00		90.00		
4030T-3038H.....Track w/Hold Open	82.00				4040XP-77.....Arm & Forearm	126.00				
4030T-72MC.....Metal Cover	28.00	197.00	241.00		4040XP-78H.....H Head & Tube	71.00				
4030T-WMS.....Screw Pack	23.00	45.00	56.00		4040XP-78HL.....Head & Long Tube	77.00				
<i>4040XP Series continued on next page</i>										
					4040XP-79.....Rod & Shoe	28.00		89.00		
					4040XP-79LR.....Long Rod & Shoe	28.00		89.00		
					4040XP-79ELR.....XL Rod & Shoe	61.00		121.00		
					4040XP-80.....Block (used with -58)	50.00				

PARTS & ACCESSORIES

PRICE LIST

PARTS & ACCESSORIES	STANDARD POWDER COAT FINISHES AL (689) DKBRZ (695) BRASS (696) LTBRZ (691) STAT (690) BLACK (693)	PLATED FINISHES			PARTS & ACCESSORIES	STANDARD POWDER COAT FINISHES AL (689) DKBRZ (695) BRASS (696) LTBRZ (691) STAT (690) BLACK (693)	PLATED FINISHES		
		US26D	US 3 US 4 US 10	US 11 US 15 US 26			US26D	US 3 US 4 US 10	US 11 US 15 US 26

4040XP Series continued

4040XP-83.....Arm Screw	2.80		
4040XP-83H.....H Arm Screw	2.80		
4040XP-95.....Arm Stud	13.00		
4040XP-107CUSH.....Metal Template	264.00		
4040XP-107EDA.....Metal Template	264.00		
4040XP-107REG.....Metal Template	264.00		
4040XP-107PA.....Metal Template	264.00		
4040XP-124.....Plug	2.80		
4040XP-159.....Arm Screw	2.80		
4040XP-201.....Spacer	4.40		
4040XP-384.....Stop	21.00		
4040XP-419.....Panel Adapter	61.00	156.00	
4040XP-3048.....Head & Tube Assy	84.00		
4040XP-3048L.....Head & Long Tube Assy	84.00		
4040XP-3080Spring Cush Block Assy (incl -58 & -80)	61.00		
4040XP-3107.....Metal Template Set	1,053.00		
4040XP-Flat Box.....Flat Box w/Label	4.40		
4040XP-Instruction Sheet.....Instruction Sheet	3.30		
4040XP-Rebox Kit.....Box & Instruction Sheet	5.00		

4040XPT Series

4040XPT-3071.....Std Cylinder Assy	373.00		
4040XPT-3077T.....Standard Arm	104.00	229.00	269.00
4040XPT-3077DE.....DE Arm	148.00	280.00	318.00
4040XPT-3038.....Standard Track	61.00		
4040XPT-3038B.....Track w/Bumper	71.00		
4040XPT-3038H.....Track w/Hold Open	82.00		
4040XPT-3038HB.....Track w/Hold Open & Bumper	94.00		
4040XPT-72.....Standard Cover	28.00		
4040XPT-72MC.....Metal Cover	38.00	207.00	257.00
4040XPT-SRT.....Screw Pack (incl -3034)	50.00	72.00	85.00
4040XPT-TBSRT.....Screw Pack (incl -3034)	50.00	72.00	85.00
4040XPT-WMS.....Screw Pack (incl -3034)	50.00	72.00	85.00
4040XPT-TBWMS.....Screw Pack (incl -3034)	50.00	72.00	85.00
4040XPT-TORX.....Screw Pack (incl -3034)	67.00	89.00	102.00
4040XPT-TBTRX.....Screw Pack (incl -3034)	67.00	89.00	102.00
4040XPT-HSRT.....HO Screw Pack (incl -3034H)	50.00	72.00	85.00
4040XPT-HTBSRT.....HO Screw Pack (incl -3034H)	50.00	72.00	85.00
4040XPT-HWMS.....HO Screw Pack (incl -3034H)	50.00	72.00	85.00
4040XPT-HTBWMS.....HO Screw Pack (incl -3034H)	50.00	72.00	85.00
4040XPT-HTORX.....HO Screw Pack (incl -3034H)	67.00	89.00	102.00
4040XPT-HTBTRX.....HO Screw Pack (incl -3034H)	67.00	89.00	102.00
4040XPT-18.....Plate	60.00	203.00	
4040XPT-18TJ.....Plate	60.00	203.00	
4040XPT-31.....Cover Screw	2.80		
4040XPT-54.....Snap-On Cover Clip Only	10.00		
4040XPT-61.....Spacer	13.00		
4040XPT-73.....End Cap	9.00		
4040XPT-78DE.....Main Arm & Tube	99.00		
4040XPT-82.....Rod	60.00		
4040XPT-83H.....H Arm Set Screw	2.80		
4040XPT-141-1.....Plug	2.80		
4040XPT-141-2.....Plug	2.80		
4040XPT-159.....Arm Screw	2.80		
4040XPT-169.....Bumper Assy	21.00		
4040XPT-425.....Roller Lock Screw	4.40		
4040XPT-3034.....Track Roller	28.00		
4040XPT-3034H.....Hold OpenTrack Roller	28.00		
4040XPT-3054.....Hold Open Clip	29.00		
4040XPT-Flat Box.....Flat Box w/Label	4.40		
4040XPT-Instruction Sheet.....Instruction Sheet	3.30		
4040XPT-Rebox Kit.....Box & Instruction Sheet	5.00		

4040SE Series

4040SE-3071.....Std Cylinder Assy	345.00		
4040SE-3077T.....Standard Arm	148.00	289.00	344.00
4040SE-3077DE.....DE Arm	196.00	336.00	391.00
4040SE-3038.....Standard Track	378.00		
4040SEL-3038SEL.....Long Track	378.00		
4040SE-72.....Standard Cover	28.00		
4040SE-72MC.....Metal Cover	38.00	207.00	257.00
4040SE-WMS.....Screw Pack (incl. -81)	29.00	51.00	62.00
4040SE-TBWMS.....Screw Pack (incl. -81)	29.00	51.00	62.00
4040SE-TORX.....Screw Pack (incl. -81)	45.00	78.00	89.00
4040SE-TBTRX.....Screw Pack (incl. -81)	45.00	78.00	89.00
4040SE-18.....Plate	60.00	203.00	
4040SE-18PA.....Plate	60.00	203.00	
4040SE-31.....Cover Screw	2.80		
4040SE-59A.....Cover Plate	5.00		
4040SE-60.....Cover Plate Screw	2.80		
4040SE-61.....Spacer	13.00		
4040SE-73.....End Cap	9.00		
4040SE-78.....Arm & Tube	71.00		
4040SE-78DE.....Main Arm & Tube	99.00		
4040SE-81.....Connector w/Ring	5.00		
4040SE-82.....Rod	60.00		
4040SE-83H.....H Arm Screw	2.80		
4040SE-141.....Plug	2.80		
4040SE-141-1.....Plug	2.80		
4040SE-141-2.....Plug	2.80		
4040SE-159.....Arm Screw	2.80		
4040SE-425.....Roller Lock Screw	4.40		
4040SE-3034SE.....Track Roller with slider	33.00		
4040SE-3210.....SE Transformer	71.00		
4040SE-3436.....On/Off Switch Assy	72.00		
4040SE-Flat Box.....Flat Box w/Label	4.40		
4040SE-Instruction Sheet.....Instruction Sheet	3.30		
4040SE-Rebox Kit.....Box & Instruction Sheet	5.00		

4040SEH Series

4040SEH-3077SEH.....SEH Arm	190.00	374.00	414.00
4040SEH-3038.....Standard SEH Track	378.00		
4040SEH-59A.....Cover Plate	5.00		
4040SEH-78SEH.....Arm & Tube	134.00	262.00	
4040SEH-82SEH.....Rod	95.00	210.00	
4040SEH-83SEH.....Arm Screw	2.80		
4040SEH-3034SEH.....Track Roller and Slider	33.00		

4050 Series

4050-3071.....Std Cylinder Assy	288.00
4050-3071DEL.....Del Cylinder Assy	330.00
4050-3077/PA.....Reg Arm w/62PA	129.00
4050-3077/62A.....Reg Arm w/62A	149.00
4050-3077L.....Long Arm	129.00
4050-3049/PA.....H Arm w/62PA	170.00
4050-3049L.....H Long Arm	170.00
4050-3077EDA.....EDA Arm	160.00
4050-3077EDA/G.....EDA Arm w/62G	165.00
4050-3049EDA.....H EDA Arm	191.00
4050-3049EDA/G.....H EDA Arm w/62G	196.00
4050-3077CNS.....Cush Arm	191.00
4050-3049CNS.....H Cush Arm	252.00
4050-3077SCNS.....S Cush Arm	252.00

4050 Series continued on next page

PARTS & ACCESSORIES

PRICE LIST

PARTS & ACCESSORIES	STANDARD POWDER COAT FINISHES AL (689) DKBRZ (695) BRASS (696) LTBRZ (691) STAT (690) BLACK (693)	PLATED FINISHES			PARTS & ACCESSORIES	STANDARD POWDER COAT FINISHES AL (689) DKBRZ (695) BRASS (696) LTBRZ (691) STAT (690) BLACK (693)	PLATED FINISHES			
		US26D	US 3 US 4 US 10	US 11 US 15 US 26			US26D	US 3 US 4 US 10	US 11 US 15 US 26	
<i>4050 Series continued</i>										
4050-3049SCNS.....Spring H Cush Arm	314.00				4050T-480.....Shaft Extender	53.00				
4050-D Rw/pA.....Reg arm w/62PA for Delay	129.00				4050T-3034.....Track Roller	28.00				
4050-D Hw/PA.....H Arm w/62PA for Delay	170.00				4050T-3034H.....Hold Open Track Roller	28.00				
4050-62DAPA.....PA shoe for Delay	15.00				4050T-3054.....Hold Open Clip	29.00				
4050-31.....Cover Screw	2.80				4050T-Flat Box.....Flat Box w/Label	4.40				
4050-72.....Standard Cover	31.00				4050T-Instruction Sheet.....Instruction Sheet	3.30				
4050-72ALT.....Alternative cover	31.00				4050T-Rebox Kit.....Box & Instruction Sheet	5.00				
4050-72MC.....Metal Cover	41.00									
4050-SRT.....Screw Pack	23.00				4110 Series					
4050-TBSRT.....Screw Pack	23.00				4111(6)-3071.....Std Cylinder Assy	333.00				
4050-WMS.....Screw Pack	23.00				4111(6)-3071AVB.....AVB Cylinder Assy	354.00				
4050-TBWMS.....Screw Pack	23.00				4111-3071DEL.....Delay Action Cylinder Assy	376.00				
4050-TORX.....Screw Pack	39.00				4111(6)-3071TEL.....TEL Cylinder Assy	376.00				
4050-TBTRX.....Screw Pack	39.00				4110-3077EDA.....EDA Arm	129.00	379.00			
4050-18.....Plate	60.00				4110-3077EDA/G.....EDA Arm w/62G	134.00	384.00	484.00		
4050-18G.....Plate	60.00				4110-3049EDA.....H EDA Arm	162.00	408.00	510.00		
4050-18PA.....Plate	60.00				4110-3049EDA/G.....H EDA Arm w/62G	167.00	413.00	515.00		
4050-30.....Cush Shoe Support	23.00				4110-3077CNS.....Cush Arm	162.00	408.00	510.00		
4050-61.....Spacer	25.00				4110-3049CNS.....H Cush Arm	221.00	465.00	573.00		
4050-62A.....Auxiliary Shoe	40.00				4110-3077SCNS.....S Cush Arm	221.00	465.00	573.00		
4050-62PA.....PA Shoe	15.00				4110-3049SCNS.....Spring H Cush Arm	276.00	520.00	618.00		
4050-419.....Panel Adapter	61.00				4110-3049FL.....FL Arm	269.00				
4050-3080.....Spring Cush Block Assy (incl -58 & -80)	61.00				4110-72.....Standard Cover	28.00				
4050-Flat Box.....Flat Box w/Label	4.40				4110-72MC.....Metal Cover	38.00	207.00	257.00		
4050-Instruction Sheet.....Instruction Sheet	3.30				4110-SRT.....Screw Pack	23.00	45.00	56.00		
4050-Rebox Kit.....Box & Instruction Sheet	5.00				4110-TBSRT.....Screw Pack	23.00	45.00	56.00		
					4110-WMS.....Screw Pack	23.00	45.00	56.00		
					4110-TBWMS.....Screw Pack	23.00	45.00	56.00		
					4110-TORX.....Screw Pack	39.00	72.00	83.00		
					4110-TBTRX.....Screw Pack	39.00	72.00	83.00		
					4110-18.....Plate	60.00	203.00			
					4110-18CUSH.....Plate	60.00	203.00			
					4110-28.....Fusible Link	11.00				
					4110-30.....Cush Shoe Support	23.00	66.00			
					4110-31.....Cover Screw	2.80				
					4110-37.....Hold Open Stud	25.00				
					4110-41.....Hold Open Nut	6.00				
					4110-48.....Hold Open Forearm	67.00				
					4110-49FL.....FL Main Arm & Rod	63.00				
					4110-58.....Spring & Screw (used with -80)	11.00				
					4110-61.....Spacer	25.00	68.00			
					4110-62FL.....PA-FL Shoe	15.00				
					4110-77EDA.....Main Arm	117.00				
					4110-80.....Block (used with -58)	50.00				
					4110-107 EDA.....Metal Template	264.00				
					4110-107 CUSH.....Metal Template	264.00				
					4110-3107.....Metal Template	526.00				
					4110-159.....Arm Screw	2.80				
					4110-201.....Spacer	4.40				
					4110-3048.....FL Forearm					
					4110-3080.....Spring Cush Block (incl -58 & -80)	61.00				
					4110-419.....Panel Adapter	61.00	156.00			
					4110-Flat Box.....Flat Box w/Label	4.40				
					4110-Instruction Sheet.....Instruction Sheet	3.30				
					4110-Rebox Kit.....Box & Instruction Sheet	5.00				
					4110T Series					
					4111(3,4)T-3071.....Std Cylinder Assy	349.00				
					4110T-3077T.....Standard Arm	94.00	223.00	263.00		
					4110T-3038.....Standard Track	59.00				
					4110T-3038B.....Track w/Bumper	69.00				
					4110T-3038H.....Track w/Hold Open	80.00				

4110T Series continued on next page

PARTS & ACCESSORIES

PRICE LIST

PARTS & ACCESSORIES	STANDARD POWDER COAT FINISHES AL (689) DKBRZ (695) BRASS (696) LTBRZ (691) STAT (690) BLACK (693)	PLATED FINISHES			PARTS & ACCESSORIES	STANDARD POWDER COAT FINISHES AL (689) DKBRZ (695) BRASS (696) LTBRZ (691) STAT (690) BLACK (693)	PLATED FINISHES			
		US26D	US 3 US 4 US 10	US 11 US 15 US 26			US26D	US 3 US 4 US 10	US 11 US 15 US 26	
<i>4110T Series continued</i>										
4110T-3038HB..... Track w/Hold Open & Bumper	91.00				4210T-3034..... Track Roller	28.00				
4110T-72..... Standard Cover	27.00				4210T-Flat Box..... Flat Box w/Label	4.40				
4110T-72MC..... Metal Cover	37.00	202.00	250.00		4210T-Instruction Sheet..... Instruction Sheet	3.30				
4110T-SRT..... Screw Pack (incl -3034)	49.00	71.00	83.00		4210T-Rebox Kit..... Box & Instruction Sheet	5.00				
4110T-TBSRT..... Screw Pack (incl -3034)	49.00	71.00	83.00		4310HSA Series					
4110T-WMS..... Screw Pack (incl -3034)	49.00	71.00	83.00		4311HSA-3071..... Std Cylinder Assy	1,061.00				
4110T-TBWMS..... Screw Pack (incl -3034)	49.00	71.00	83.00		4311HSA-3971..... Cylinder Only	961.00				
4110T-TORX..... Screw Pack (incl -3034)	65.00	87.00	99.00		4310HSA-3077T..... Standard Arm	99.00	231.00	276.00		
4110T-TBTRX..... Screw Pack (incl -3034)	65.00	87.00	99.00		4310HSA-3077DE..... DE Arm	145.00	277.00	322.00		
4110T-HSRT..... HO Screw Pack (incl -3034H)	49.00	71.00	83.00		4310HSA-3038..... Standard Track	61.00				
4110T-HTBSRT..... HO Screw Pack (incl -3034H)	49.00	71.00	83.00		4310HSA-72MC..... Metal Cover	92.00	321.00	379.00		
4110T-HWMS..... HO Screw Pack (incl -3034H)	49.00	71.00	83.00		4310HSA-WMS..... Screw Pack (incl -3034)	50.00	72.00	85.00		
4110T-HTBWMS..... HO Screw Pack (incl -3034H)	49.00	71.00	83.00		4310HSA-TBWMS..... Screw Pack (incl -3034)	50.00	72.00	85.00		
4110T-HTORX..... HO Screw Pack (incl -3034H)	65.00	87.00	99.00		4310HSA-TORX..... Screw Pack (incl -3034)	67.00	89.00	102.00		
4110T-HTBTRX..... HO Screw Pack (incl -3034H)	65.00	87.00	99.00		4310HSA-TBTRX..... Screw Pack (incl -3034)	67.00	89.00	102.00		
4110T-18..... Plate	58.00	197.00	237.00		4310HSA-18..... Plate	181.00	311.00			
4110T-31..... Cover Screw	2.70				4310HSA-31..... Cover Screw	2.80				
4110T-73..... End Cap	9.00				4310HSA-61..... Spacer	13.00				
4110T-141-1..... Plug	2.70				4310HSA-73..... End Cap	9.00				
4110T-159..... Arm Screw	2.70				4310HSA-83..... Arm Screw	2.80				
4110T-169..... Bumper Assy	20.00				4310HSA-141-2..... Plug	2.80				
4110T-425..... Roller Lock Screw	4.30				4310HSA-159..... Arm Screw	2.80				
4110T-3034..... Track Roller	27.00				4310HSA-425..... Roller Lock Screw	4.40				
4110T-3034H..... Hold Open Track Roller	27.00				4310HSA-3034..... Track Roller	28.00				
4110T-3054..... Hold Open Clip	28.00				4310HSA-3210..... Transformer	71.00				
4110T-3064H..... HO Roller and Clip	54.00				4310HSA-3428..... Scanner Module	165.00				
4110T-Flat Box..... Flat Box w/Label	4.30				4410HSA-3430..... HSA Solenoid Harness	7.00				
4110T-Instruction Sheet..... Instruction Sheet	3.20				4310HSA-3431..... Input Harness	6.00				
4110T-Rebox Kit..... Box & Instruction Sheet	5.00				4410HSA-3448..... HSA PCB Module	24.00				
					4310HSA-Flat Box..... Flat Box w/Label	4.40				
					4310HSA-Instruction Sheet..... Instruction Sheet	3.30				
					4310HSA-Rebox Kit..... Box & Instruction Sheet	5.00				
4210 Series										
4211(6)-3071..... Std Cylinder Assy	373.00				4310ME Series					
4211(6)-3071AVB..... AVB Cylinder Assy	394.00				4314ME-3071..... Std Cylinder Assy	973.00				
4211-3071DEL..... Del Action Cylinder Assy	416.00				4314ME-3071B80..... B80 Cylinder Assy	1,061.00				
4210-3077EDA..... EDA Arm	130.00	319.00	483.00		4314ME-3071B140..... B140 Cylinder Assy	1,061.00				
4210-3077CNS..... Cush Arm	163.00	379.00	511.00		4314ME-3971..... Cylinder Only	873.00				
4210-3049CNS..... H Cush Arm	222.00	466.00	564.00		4314ME-3971B80..... B80 Cylinder Only	961.00				
4210-72MC..... Metal Cover	38.00	205.00	257.00		4314ME-3971B140..... B140 Cylinder Only	961.00				
4210-TORX..... Screw Pack	39.00	72.00	83.00		4310ME-3077SF..... Swing Free Arm	131.00	274.00	318.00		
4210-TBTRX..... Screw Pack	39.00	72.00	83.00		4310ME-3077DE..... DE Arm	176.00	319.00	363.00		
4210-18..... Plate	82.00	282.00			4310ME-3038..... Standard Track	61.00				
4210-18CUSH..... Plate	82.00	282.00			4310ME-72MC..... Metal Cover	92.00	321.00	379.00		
4210-30..... Cush Shoe Support	23.00	66.00			4310ME-WMS..... Screw Pack (incl -3034)	50.00	72.00	85.00		
4210-31..... Cover Screw	2.80				4310ME-TBWMS..... Screw Pack (incl -3034)	50.00	72.00	85.00		
4210-61..... Spacer	25.00	66.00			4310ME-TORX..... Screw Pack (incl -3034)	67.00	89.00	102.00		
4210-159..... Arm Screw	2.80				4310ME-TBTRX..... Screw Pack (incl -3034)	67.00	89.00	102.00		
4210-201..... Spacer	4.40				4310ME-18..... Plate	181.00	311.00			
4210-419..... Panel Adapter	61.00	156.00			4310ME-31..... Cover Screw	2.80				
4210-Flat Box..... Flat Box w/Label	4.40				4310ME-61..... Spacer	13.00				
4210-Instruction Sheet..... Instruction Sheet	3.30				4310ME-73..... End Cap	9.00				
4210-Rebox Kit..... Box & Instruction Sheet	5.00				4310ME-83..... Arm Screw	2.80				
					4310ME-141-2..... Plug	2.80				
					4310ME-159..... Arm Screw	2.80				
					4310ME-425..... Roller Lock Screw	4.40				
					4310ME-3034..... Track Roller	28.00				
					4310ME-3210..... Transformer	71.00				
					4310ME-3351..... ME Switch Assy	165.00				
					4310ME-3354..... ME Wire Harness	16.00				
					4310ME-3431..... Input Harness	6.00				
					4310ME-Flat Box..... Flat Box w/Label	4.40				
					4310ME-Instruction Sheet..... Instruction Sheet	3.30				
					4310ME-Rebox Kit..... Box & Instruction Sheet	5.00				

PARTS & ACCESSORIES

PRICE LIST

PARTS & ACCESSORIES	STANDARD POWDER COAT FINISHES AL (689) DKBRZ (695) BRASS (696) LTBRZ (691) STAT (690) BLACK (693)	PLATED FINISHES			PARTS & ACCESSORIES	STANDARD POWDER COAT FINISHES ANCLR ANDKB	PLATED FINISHES		
		US26D	US 3 US 4 US 10	US 11 US 15 US 26			US26D	US 3 US 4 US 10	US 11 US 15 US 26
4410HSA Series									
4414HSA-3071.....Std Cylinder Assy	1,033.00				4511-3071DEL.....Del Action Cylinder Assy	416.00			
4414HSA-3071/18G.....Std Cyl. Assy w/18G	1,033.00				4510-3077EDA.....EDA Arm	142.00	376.00		470.00
4414HSA-3971.....Cylinder Only	933.00				4510-72MC.....Metal Cover	38.00	207.00		257.00
4410HSA-3077.....Reg Arm	128.00	379.00	478.00		4510-TORX.....Screw Pack	39.00	72.00		83.00
4410HSA-3077L.....Long Arm	162.00	411.00	510.00		4510-TBTRX.....Screw Pack	39.00	72.00		83.00
4410HSA-72MC.....Metal Cover	92.00	321.00	379.00		4510-18.....Plate	82.00	282.00		
4410HSA-WMS.....Screw Pack	23.00	45.00	56.00		4510-31.....Cover Screw	2.80			
4410HSA-TBWMS.....Screw Pack	23.00	45.00	56.00		4510-159.....Arm Screw	2.80			
4410HSA-TORX.....Screw Pack	39.00	72.00	83.00		4510-Flat Box.....Flat Box w/Label	4.40			
4410HSA-TBTRX.....Screw Pack	39.00	72.00	83.00		4510-Instruction Sheet.....Instruction Sheet	3.30			
4410HSA-18.....Plate	181.00	311.00			4510-Rebox Kit.....Box & Instruction Sheet	5.00			
4410HSA-18G.....Mounting Plate	181.00	311.00			4510T Series				
4410HSA-31.....Cover Screw	2.80				4511(3,4)T-3071.....Std Cylinder Assy	362.00			
4410HSA-77.....Arm & Forearm	117.00				4511(3,4)T-3071AVB.....AVB Cylinder Assy	383.00			
4410HSA-77L.....Long Arm & Forearm	123.00				4510T-3077T.....Standard Arm	152.00	285.00		325.00
4410HSA-79.....Rod & Shoe	28.00	89.00			4510T-3038.....Standard Track	91.00			
4410HSA-79L.....Long Rod & Shoe	44.00	108.00			4510T-72MC.....Metal Cover	37.00	202.00		250.00
4410HSA-83H.....H Arm Screw	2.80				4510T-TORX.....Screw Pack	38.00	71.00		81.00
4410HSA-159.....Arm Screw	2.80				4510T-TBTRX.....Screw Pack	38.00	71.00		81.00
4410HSA-3210.....Transformer	71.00				4510T-18.....Plate	80.00	275.00		324.00
4410HSA-3428.....Scanner Module	165.00				4510T-31.....Cover Screw	2.70			
4410HSA-3430.....HSA Solenoid Harness	7.00				4510T-159.....Arm Screw	2.70			
4410HSA-3431.....Input Harness	6.00				4510T-3034.....Track Roller	27.00			
4410HSA-3448.....HSA PCB Module	24.00				4510T-Flat Box.....Flat Box w/Label	4.30			
4410HSA-Flat Box.....Flat Box w/Label	4.40				4510T-Instruction Sheet.....Instruction Sheet	3.20			
4410HSA-Instruction Sheet.....Instruction Sheet	3.30				4510T-Rebox Kit.....Box & Instruction Sheet	5.00			
4410HSA-Rebox Kit.....Box & Instruction Sheet	5.00				4630 Series				
4410ME Series									
4414ME-3071.....Std Cylinder Assy	946.00				4631-3071.....Std Cylinder Assy	5,343.00			
4414ME-3071/18G.....Std Cyl. Assy w/18G	946.00				4631-3071CS.....Cyl Assy w/Conc I/O Switch	5,343.00			
4414ME-3071B80.....B80 Cylinder Assy	1,033.00				4631-3971.....Cylinder Only	1,942.00			
4414ME-3071B80G.....B80 Cyl. Assy w/18G	1,033.00				4630-3077T.....Standard Arm	141.00	273.00		327.00
4414ME-3071B140.....B140 Cylinder Assy	1,033.00				4630-3038.....Standard Track	61.00			
4414ME-3071B140G.....B140 Cyl. Assy w/18G	1,033.00				4630-72MC.....Metal Cover	137.00	383.00		443.00
4414ME-3971.....Cylinder Only	846.00				4630-WMS.....Screw Pack (incl -3034)	77.00	98.00		108.00
4414ME-3971B80.....B80 Cylinder Only	933.00				4630-TBWMS.....Screw Pack (incl -3034)	77.00	98.00		108.00
4414ME-3971B140.....B140 Cylinder Only	933.00				4630-TORX.....Screw Pack (incl -3034)	94.00	115.00		125.00
4410ME-3077.....Reg Arm	128.00	379.00	478.00		4630-TBTRX.....Screw Pack (incl -3034)	94.00	115.00		125.00
4410ME-3077L.....Long Arm	162.00	411.00	510.00		4630-31.....Cover Screw	2.80			
4410ME-72MC.....Metal Cover	92.00	321.00	379.00		4630-61.....Spacer	13.00			
4410ME-WMS.....Screw Pack	23.00	45.00	56.00		4630-73.....End Cap	9.00			
4410ME-TBWMS.....Screw Pack	23.00	45.00	56.00		4630-78.....Arm & Tube	71.00	179.00		
4410ME-TORX.....Screw Pack	39.00	72.00	83.00		4630-82.....Rod	60.00	137.00		
4410ME-TBTRX.....Screw Pack	39.00	72.00	83.00		4630-83H.....H Arm Screw	2.80			
4410ME-18.....Plate	181.00	311.00			4630-141-2.....Plug	2.80			
4410ME-18G.....Mounting Plate	181.00	311.00			4630-155-1.....Caution Decal	5.00			
4410ME-31.....Cover Screw	2.80				4630-155-2.....Activation Decal	5.00			
4410ME-77.....Arm & Forearm	117.00				4630-159.....Arm Screw	2.80			
4410ME-77L.....Long Arm & Forearm	123.00				4630-334.....End Cap	41.00			
4410ME-79.....Rod & Shoe	28.00	89.00			4630-334-2.....End Cap, Plain	41.00			
4410ME-79L.....ME Long Rod	44.00	108.00			4630-334CS.....End Cap, Concealed Switch	41.00			
4410ME-83H.....H Arm Screw	2.80				4630-425.....Roller Lock Screw	4.40			
4410ME-159.....Arm Screw	2.80				4630-480.....Shaft Extension	53.00			
4410ME-3210.....Transformer	71.00				4630-3018.....Mounting Plate Assy	3,126.00			
4410ME-3351.....ME Switch Assy	165.00				4630-3034.....Track Roller	28.00			
4410ME-3354.....ME Wire Harness	16.00				4630-3179-1.....On/Off Switch Assy	49.00			
4410ME-3431.....Input Harness	6.00				4630-3179-2.....Hold Open Switch Assy	49.00			
4410ME-Flat Box.....Flat Box w/Label	4.40				4630-3180.....I/O Board Assy	335.00			
4410ME-Instruction Sheet.....Instruction Sheet	3.30				4630-3454.....Motor/Clutch Assy	1,590.00			
4410ME-Rebox Kit.....Box & Instruction Sheet	5.00				4630-3462.....Controller Assy	1,810.00			
4510 Series									
4511(6)-3071.....Std Cylinder Assy	373.00				4630-3498-1.....Ribbon Cable Connector	24.00			
4511(6)-3071AVB.....AVB Cylinder Assy	394.00				4630-3498-2.....A/C Power Cable	49.00			
					4630-Flat Box.....Flat Box w/Label	4.40			
					4630-Instruction Sheet.....Instruction Sheet	3.30			
					4630-Rebox Kit.....Box & Instruction Sheet	5.00			

4630 Series continued on next page

PARTS & ACCESSORIES

PRICE LIST

PARTS & ACCESSORIES	STANDARD POWDER COAT FINISHES ANCLR ANDKB	PLATED FINISHES			PARTS & ACCESSORIES	STANDARD POWDER COAT FINISHES ANCLR ANDKB	PLATED FINISHES		
		US26D	US 3 US 4 US 10	US 11 US 15 US 26			US 11 US 15 US 26	US 3 US 4 US 10	US 11 US 15 US 26
4640 Series									
4642-3071.....Std Cylinder Assy	5,320.00				4822-3071/18G.....Std Cylinder Assy w/18G	1,788.00			
4642-3071CS.....Cyl Assy w/Conc I/O Switch	5,320.00				4822-3971.....Cylinder Only	1,727.00			
4642-3971.....Cylinder Only	1,920.00				4820-3077.....Reg Arm	137.00	408.00	509.00	
4640-3077.....Reg Arm	128.00	387.00	483.00		4820-3077L.....Long Arm	159.00	435.00	534.00	
4640-3077L.....Long Arm	155.00	414.00	510.00		4820-72MC.....Metal Cover	137.00	343.00	400.00	
4640-72MC.....Metal Cover	137.00	383.00	443.00		4820-WMS.....Screw Pack	23.00	45.00	56.00	
4640-WMS.....Screw Pack	49.00	70.00	80.00		4820-TBWMS.....Screw Pack	23.00	45.00	56.00	
4640-TBWMS.....Screw Pack	49.00	70.00	80.00		4820-18.....Plate	214.00	344.00		
4640-TORX.....Screw Pack	66.00	87.00	97.00		4820-18G.....Plate	214.00	344.00		
4640-TBTRX.....Screw Pack	66.00	87.00	97.00		4820-31.....Cover Screw	2.80			
4640-31.....Cover Screw	2.80				4820-31L.....Long Cover Screw	2.80			
4640-77.....Arm & Forearm	118.00	265.00			4820-77.....Arm & Forearm	118.00	265.00		
4640-79.....Rod & Shoe	28.00	89.00			4820-79.....Rod & Shoe	28.00	89.00		
4640-79LR.....Long Rod & Shoe	55.00	112.00			4820-79LR.....Long Rod & Shoe	55.00	112.00		
4640-83.....Arm Screw	2.80				4820-83.....Arm Screw	2.80			
4640-155-1.....Caution Decal	5.00				4820-155-1.....Caution Decal	5.00			
4640-155-2.....Activation Decal	5.00				4820-155-2.....Activation Decal	5.00			
4640-159.....Arm Screw	2.80				4820-159.....Arm Screw	2.80			
4640-334.....End Cap	41.00				4820-163.....Cover Insert	5.00			
4640-334-2.....End Cap, Plain	41.00				4820-182.....Stand Off	13.00			
4640-334CS.....End Cap, Concealed Switch	41.00				4820-334.....Cover End Cap	12.00			
4640-480.....Shaft Extension	53.00				4820-3377.....DPS Conversion Kit	403.00			
4640-3018.....Mounting Plate Assy	3,126.00				4820-Flat Box.....Flat Box w/Label	4.40			
4640-3179-1.....On/Off Switch Assy	49.00				4820-Instruction Sheet.....Instruction Sheet	3.30			
4640-3179-2.....Hold Open Switch Assy	49.00				4820-Rebox Kit.....Box & Instruction Sheet	5.00			
4640-3180.....I/O Board Assy	335.00				4840 Series				
4640-3454.....Motor/Clutch Assy	1,590.00				4841-3071.....Std Cylinder Assy	1,788.00			
4640-3462.....Controller Assy	1,810.00				4841-3971.....Cylinder Only	1,727.00			
4640-3498-1.....Ribbon Cable Connector	24.00				4840-3077EDA.....EDA Arm	181.00	437.00	541.00	
4640-3498-2.....A/C Power Cable	49.00				4840-3077CNS.....Cush Arm	214.00	467.00	569.00	
4640-Flat Box.....Flat Box w/Label	4.40				4840-3077SCNS.....Spring Cush Arm	269.00	524.00	625.00	
4640-Instruction Sheet.....Instruction Sheet	3.30				4840-72MC.....Metal Cover	137.00	343.00	400.00	
4640-Rebox Kit.....Box & Instruction Sheet	5.00				4840-WMS.....Screw Pack	23.00	45.00	56.00	
4810 Series									
4811-3071.....Std Cylinder Assy	1,816.00				4840-TBWMS.....Screw Pack	23.00	45.00	56.00	
4811-3971.....Cylinder Only	1,727.00				4840-30.....Cush Shoe Support	23.00	45.00	56.00	
4810-3077T.....Standard Arm	150.00	285.00	343.00		4840-31.....Cover Screw	2.80			
4810-3038.....Standard Track	61.00				4840-31L.....Long Cover Screw	2.80			
4810-72MC.....Metal Cover	137.00	343.00	400.00		4840-61.....Spacer	25.00	68.00		
4810-WMS.....Screw Pack (incl -3034)	50.00	72.00	85.00		4840-124.....Plug	2.80			
4810-TBWMS.....Screw Pack (incl -3034)	50.00	72.00	85.00		4840-155-1.....Caution Decal	5.00			
4810-18.....Plate	214.00	344.00			4840-155-2.....Activation Decal	5.00			
4810-31.....Cover Screw	2.80				4840-159.....Arm Screw	2.80			
4810-31L.....Long Cover Screw	2.80				4840-163.....Cover Insert	5.00			
4810-61.....Spacer	13.00				4840-182.....Stand Off	13.00			
4810-73.....End Cap	9.00				4840-201.....Spacer	4.40			
4810-78.....Arm & Tube	71.00	179.00			4840-334.....Cover End Cap	12.00			
4810-82.....Rod	60.00				4840-419.....Panel Adapter	61.00	156.00		
4810-83H.....H Arm Screw	2.00				4840-459.....Door Loop Kit	133.00			
4810-141-2.....Plug	2.80				4840-460.....Pneumatic Hinge	507.00			
4810-155-1.....Caution Decal	5.00				4840-3080.....Spring Cush Block	61.00			
4810-155-2.....Activation Decal	5.00				4840-Flat Box.....Flat Box w/Label	4.40			
4810-159.....Arm Screw	2.80				4840-Instruction Sheet.....Instruction Sheet	3.30			
4810-163.....Cover Insert	5.00				4840-Rebox Kit.....Box & Instruction Sheet	5.00			
4810-182.....Stand Off	13.00				5010 Series				
4810-334.....Cover End Cap	12.00				5011(2,3,4,5,6)-3071.....Std Cylinder Assy	486.00	633.00	688.00	
4810-425.....Roller Lock Screw	4.40				5011(2,3,4,5)-3071DEL.....Del Act Cyl Assy	529.00	676.00	731.00	
4810-3034.....Track Roller	28.00				5010-3077.....Reg Arm	125.00	379.00	477.00	
4810-Flat Box.....Flat Box w/Label	4.40				5010-3049.....Hold Open Arm	158.00	411.00	509.00	
4810-Instruction Sheet.....Instruction Sheet	3.30				5010-WMS.....Screw Pack	23.00	66.00	81.00	
4810-Rebox Kit.....Box & Instruction Sheet	5.00				5010-TORX.....Screw Pack	39.00	72.00	83.00	
4820 Series									
4822-3071.....Std Cylinder Assy	1,788.00				5010-11.....Finish Plate	54.00	209.00		
<i>5010 Series continued on next page</i>									

PARTS & ACCESSORIES

PRICE LIST

PARTS & ACCESSORIES	STANDARD POWDER COAT FINISHES <i>AL (689) DKBRZ (695) BRASS (696) LTBRZ (691) STAT (690) BLACK (693)</i>	PLATED FINISHES			PARTS & ACCESSORIES	STANDARD POWDER COAT FINISHES <i>ANCLR ANDKB</i>	PLATED FINISHES	
		US26D	US 3 US 4 US 10	US 11 US 15 US 26				

5010 Series continued

5010-41.....	Hold Open Nut	6.00
5010-45.....	Hold Open Shoe	23.00
5010-48.....	Hold Open Forearm	67.00
5010-49.....	Hold Open Main Arm	63.00
5010-77.....	Arm & Forearm	117.00
5010-79.....	Rod & Shoe	28.00
5010-79H.....	H Rod & Shoe	28.00
5010-83.....	Arm Screw	2.80
5010-83H.....	H Arm Screw	2.80
5010-95.....	Arm Stud	13.00
5010-159.....	Arm Screw	2.80
5010-3002.....	Mounting/Finish Plate	69.00
5010-Flat Box.....	Flat Box w/Label	4.40
5010-Instruction Sheet.....	Instruction Sheet	3.30
5010-Rebox Kit.....	Box & Instruction Sheet	5.00

5030 Series

5031(3,4,5,6)-3071.....	Std Cylinder Assy	901.00	1,161.00	1,249.00
5031(3,4,5,6)-3971.....	Cylinder Only	836.00		
5030-3077.....	Reg Arm	125.00	379.00	477.00
5030-3049.....	Hold Open Arm	158.00	411.00	509.00
5030-WMS.....	Screw Pack	23.00	66.00	81.00
5030-TORX.....	Screw Pack	39.00	72.00	83.00
5030-37.....	Hold Open Stud	25.00		
5030-41.....	Hold Open Nut	6.00		
5030-48.....	Hold Open Forearm	67.00		
5030-49.....	Hold Open Main Arm	63.00	153.00	
5030-77.....	Arm & Forearm	117.00	259.00	
5030-79.....	Rod & Shoe	28.00	89.00	
5030-79H.....	H Rod & Shoe	28.00	89.00	
5030-83.....	Arm Screw	2.80		
5030-83H.....	H Arm Screw	2.80		
5030-159.....	Arm Screw	2.80		
5030-416.....	Wood Clip Set	157.00	224.00	
5030-417.....	Wood Clip Set	157.00	224.00	
5030-3002.....	Mounting/Finish Plate	147.00	286.00	
5030-Flat Box.....	Flat Box w/Label	4.40		
5030-Instruction Sheet.....	Instruction Sheet	3.30		
5030-Rebox Kit.....	Box & Instruction Sheet	5.00		

6030 Series

6031(2,3,4,5)-3071.....	Std Cylinder Assy	1,059.00	1,300.00	1,442.00
6031(2,3,4,5)-3971.....	Cylinder Only	971.00		
6030-3077T.....	Standard Arm	191.00	350.00	454.00
6030-3038B.....	Track w/Bumper	71.00		
6030-3038HB.....	Track w/Hold Open & Bumper	94.00		
6030-WMS.....	Screw Pack (incl -3034)	50.00	72.00	85.00
6030-TORX.....	Screw Pack (incl -3034)	67.00	89.00	102.00
6030-83.....	Arm Screw	2.80		
6030-157.....	Snubber	16.00		
6030-159.....	Arm Screw	2.80		
6030-169.....	Bumper Assy	21.00		
6030-416.....	Wood Clip Set	157.00	224.00	
6030-425.....	Roller Lock Screw	4.40		
6030-3002.....	Mounting/Finish Plate	193.00	213.00	
6030-3034.....	Track Roller	33.00		
6030-3034H.....	Hold Open Track Roller	33.00		
6030-3054.....	Hold Open Clip	29.00		
6030-Flat Box.....	Flat Box w/Label	4.40		
6030-Instruction Sheet.....	Instruction Sheet	3.30		
6030-Rebox Kit.....	Box & Instruction Sheet	5.00		

9130 Series - (ANCLR or ANDKB only)

9130-3077T.....	Standard Arm	192.00
9130-3077PLCM.....	Standard Arm w/Track	263.00

9130-3038.....	Track	71.00
9130-72MC*.....	Metal Cover	150.00
9130-72FC*.....	Full Metal Cover	253.00
9130-MS.....	Screw Pack	23.00
9130-73.....	Track End Cap	9.00
9130-163.....	Cover Insert	12.00
9130-163-1.....	Cover End Cap Insert	12.00
9130-334.....	Cover End Cap	41.00
9130-360.....	24v SO Kit	24.00
9130-3018.....	Mounting Bracket	144.00
9130-3155.....	Label Kit	28.00
9130-3034.....	Track Roller	33.00
9130-3351-1.....	Switch Bracket 29"	66.00
9130-3351-2.....	Switch Bracket 41"	66.00
9130-3351-3.....	Switch Bracket 51"	66.00
9130-3454.....	Motor Gearbox Assembly	1,843.00
9130-3454S.....	Motor Gearbox Assembly w/Switch	1,843.00
9130-3462SC.....	Standard Control Box	1,267.00
9130-3498-2A.....	A/C Power Cable - 29"	40.00
9130-3498-2B.....	A/C Power Cable - 42"	40.00
9130-3498-2C.....	A/C Power Cable - 52"	40.00
9130-Rebox Kit.....	Box & Instruction Sheet	5.00

9140 Series - (ANCLR or ANDKB only)

9140-3077.....	Regular Arm	148.00
9140-3077L.....	Long Arm	153.00
9140-72MC*.....	Metal Cover	150.00
9140-72FC*.....	Full Metal Cover	253.00
9140-MS.....	Screw Pack	23.00
9140-77.....	Main Arm	113.00
9140-79.....	Rod	23.00
9140-79LR.....	Long Rod	46.00
9140-163.....	Cover Insert	12.00
9140-163-1.....	Cover End Cap Insert	12.00
9140-334.....	Cover End Cap	41.00
9140-3018.....	Mounting Bracket	144.00
9140-3155.....	Label Kit	28.00
9140-3351-1.....	Switch Bracket 29"	66.00
9140-3351-2.....	Switch Bracket 41"	66.00
9140-3351-3.....	Switch Bracket 51"	66.00
9140-3454.....	Motor Gearbox Assembly	1,843.00
9140-3454S.....	Motor Gearbox Assembly w/Switch	1,843.00
9140-3462SC.....	Standard Control Box	1,267.00
9140-3498-2A.....	A/C Power Cable - 29"	40.00
9140-3498-2B.....	A/C Power Cable - 42"	40.00
9140-3498-2C.....	A/C Power Cable - 52"	40.00
9140-Rebox Kit.....	Box & Instruction Sheet	5.00

9150 Series - (ANCLR or ANDKB only)

9150-3077.....	Regular Arm	148.00
9150-3077L.....	Long Arm	153.00
9150-72MC*.....	Metal Cover	253.00
9150-MS.....	Screw Pack	23.00
9150-77.....	Main Arm	113.00
9150-79.....	Rod	23.00
9150-79LR.....	Long Rod	46.00
9150-163.....	Cover Insert	12.00
9150-163-1.....	Cover End Cap Insert	12.00
9150-334.....	Cover End Cap	41.00
9150-360.....	24v SO Kit	24.00
9150-3018.....	Mounting Bracket	144.00
9150-3155.....	Label Kit	28.00
9150-3351-1.....	Switch Bracket 29"	66.00
9150-3351-2.....	Switch Bracket 41"	66.00
9150-3351-3.....	Switch Bracket 51"	66.00

9150 Series continued on next page

PARTS & ACCESSORIES

PRICE LIST

PARTS & ACCESSORIES	STANDARD POWDER COAT FINISHES ANCLR ANDKB	PLATED FINISHES		PARTS & ACCESSORIES	STANDARD POWDER COAT FINISHES ANCLR ANDKB	PLATED FINISHES	

9150 Series continued

9150-3454	Motor Gearbox Assembly	1,843.00
9150-3454S	Motor Gearbox Assembly w/Switch	1,843.00
9150-3462SC	Standard Control Box	1,267.00
9150-3498-2A	A/C Power Cable	40.00
9150-Rebox Kit	Box & Instruction Sheet	5.00

9530 Series - (ANCLR or ANDKB only)

9530-3077T	Standard Arm	280.00
9530-3077PLCM	Standard Arm w/Track	351.00
9530-3038	Track	71.00
9530-3572HL*	Header Asy	345.00
9530-3572DD*	Double Door Header Assy	587.00
9530-MS	Screw Pack	23.00
9530-11A	Spindle Plate - 2 3/4"	77.00
9530-11B	Spindle Plate - 3 3/4"	77.00
9530-12*	Blank Filler Plate	94.00
9530-18*	Mounting Plate**	79.00 / ft
	**Add 3 1/2" if Using Angled Brackets	
9530-73	Track End Cap	9.00
9530-275	Mounting Bracket - 2 3/4"	104.00
9530-334	Header Endcap	45.00
9530-334-1	Angled Bracket	162.00
9530-334-2	End Dress Plate	77.00
9530-375	Mounting Bracket - 3 3/4"	104.00
9530-511*	Dress Plate Extrusion Only	18.00 / ft
9530-518	Cable/Parts Bag	94.00
9530-572*	Header Extrusion Only	55.00 / ft
9530-572HL*	Header Only	221.00
9530-572DD*	Double Door Header Only	469.00
9530-3018	Rear Mount Bracket	102.00
9530-3034	Track Roller	33.00
9530-3155	Label Kit	28.00
9530-3454	Motor Gearbox (Std Force)	2,304.00
9530-3462	Controller	1,498.00

9540 Series - (ANCLR or ANDKB only)

9540-3077	Regular Arm	258.00
9540-3077L	Long Arm	264.00
9540-3572HL*	Header Asy	345.00
9540-3572DD*	Double Door Header Assy	587.00
9540-MS	Screw Pack	23.00
9540-11A	Spindle Plate - 2 3/4"	77.00
9540-11B	Spindle Plate - 3 3/4"	77.00
9540-12*	Blank Filler Plate	94.00
9540-18*	Mounting Plate**	79.00 / ft
	**Add 3 1/2" if Using Angled Brackets	
9540-77	Main Arm	193.00
9540-79	Rod & Shoe	56.00
9540-79LR	Long Rod	62.00
9540-82	Rod	37.00
9540-82L	Long Rod	37.00
9540-275	Mounting Bracket - 2 3/4"	104.00
9540-334	Header Endcap	45.00
9540-334-1	Angled Bracket	162.00
9540-334-2	End Dress Plate	77.00
9540-375	Mounting Bracket - 3 3/4"	104.00
9540-511*	Dress Plate Extrusion Only	18.00 / ft
9540-518	Cable/Parts Bag	94.00
9540-572*	Header Extrusion Only	55.00 / ft
9540-572HL*	Header Only	221.00
9540-572DD*	Double Door Header Only	469.00
9540-3018	Rear Mount Bracket	102.00
9540-3155	Label Kit	28.00
9540-3454	Motor Gearbox (Std Force)	2,304.00
9540-3462	Controller	1,498.00

9550 Series - (ANCLR or ANDKB only)

9550-3077	Regular Arm	258.00
9550-3077L	Long Arm	264.00
9550-3077T	Standard Arm	280.00
9550-3077PLCM	Standard Arm w/Track	351.00
9550-3038	Track	71.00
9550-3572HL*	Header Asy	587.00
9550-MS	Screw Pack	23.00
9550-11A	Spindle Plate - 2 3/4"	77.00
9550-11B	Spindle Plate - 3 3/4"	77.00
9550-12*	Blank Filler Plate	94.00
9550-18*	Mounting Plate**	79.00 / ft
	**Add 3 1/2" if Using Angled Brackets	
9550-77	Main Arm	193.00
9550-79	Rod & Shoe	56.00
9550-79LR	Long Rod & Shoe	62.00
9550-82	Rod	37.00
9550-82L	Long Rod	37.00
9550-275	Mounting Bracket - 2 3/4"	104.00
9550-334	Header Endcap	45.00
9550-334-1	Angled Bracket	162.00
9550-334-2	End Dress Plate	77.00
9550-375	Mounting Bracket - 3 3/4"	104.00
9550-511	Dress Plate Extrusion Only	18.00 / ft
9550-518	Cable/Parts Bag	94.00
9550-572*	Header Extrusion Only	55.00 / ft
9550-572HL*	Header Only	443.00
9550-982	Companion Cable	70.00
9550-3018	Rear Mount Bracket	102.00
9550-3034	Track Roller	33.00
9550-3155	Label Kit	28.00
9550-3454	Motor Gearbox (Std Force)	2,304.00
9550-3462	Controller	1,498.00

9560 Series - (ANCLR or ANDKB only)

9560-3077	Regular Arm	250.00
9560-3077L	Long Arm	256.00
9560-3077T	Standard Arm	272.00
9560-3077PLCM	Standard Arm w/Track	341.00
9560-3038	Track	69.00
9560-3572HL*	Header Asy	570.00
9560-MS	Screw Pack	22.00
9560-11A	Spindle Plate - 2 3/4"	75.00
9560-11B	Spindle Plate - 3 3/4"	75.00
9560-12*	Blank Filler Plate	91.00
9560-18*	Mounting Plate**	77.00 / ft
	**Add 3 1/2" if Using Angled Brackets	
9560-77	Main Arm	193.00
9560-79	Rod & Shoe	56.00
9560-79LR	Long Rod & Shoe	62.00
9560-82	Rod	37.00
9560-82L	Long Rod	37.00
9560-275	Mounting Bracket - 2 3/4"	104.00
9560-334	Header Endcap	45.00
9560-334-1	Angled Bracket	162.00
9560-334-2	End Dress Plate	77.00
9560-375	Mounting Bracket - 3 3/4"	104.00
9560-511*	Dress Plate Extrusion Only	18.00 / ft
9560-518	Cable/Parts Bag	94.00
9560-572*	Header Extrusion Only	55.00 / ft
9560-572HL*	Header Only	443.00
9560-3018	Rear Mount Bracket	102.00
9560-3034	Track Roller	33.00
9560-3155	Label Kit	28.00
9560-3454	Motor Gearbox (Std Force)	2,304.00
9560-3462	Controller	1,498.00

Senior Swing® Basic Parts Diagram (2800 / 9500 Series)

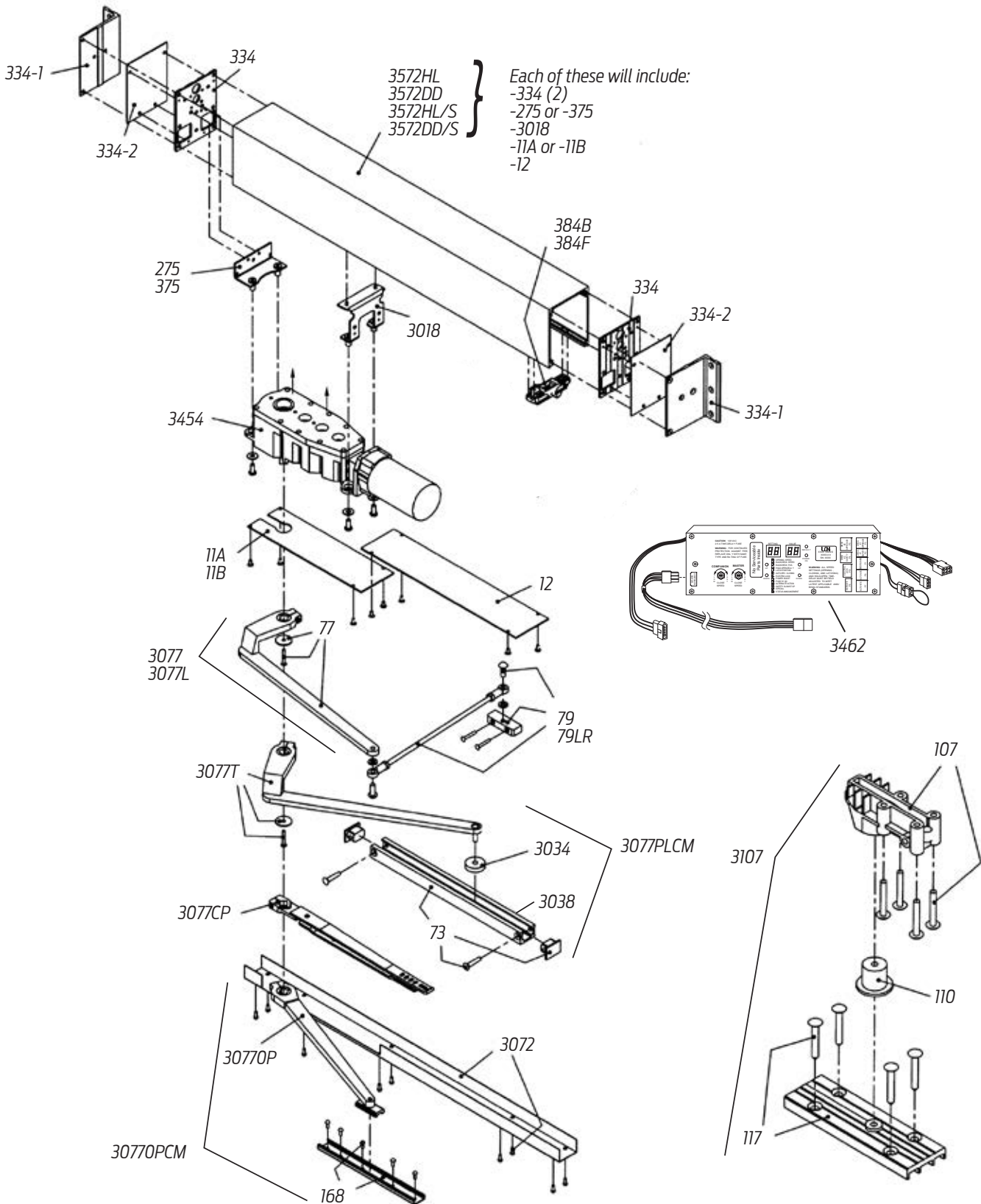

Benchmark Basic Parts Diagram

(9100 Series)

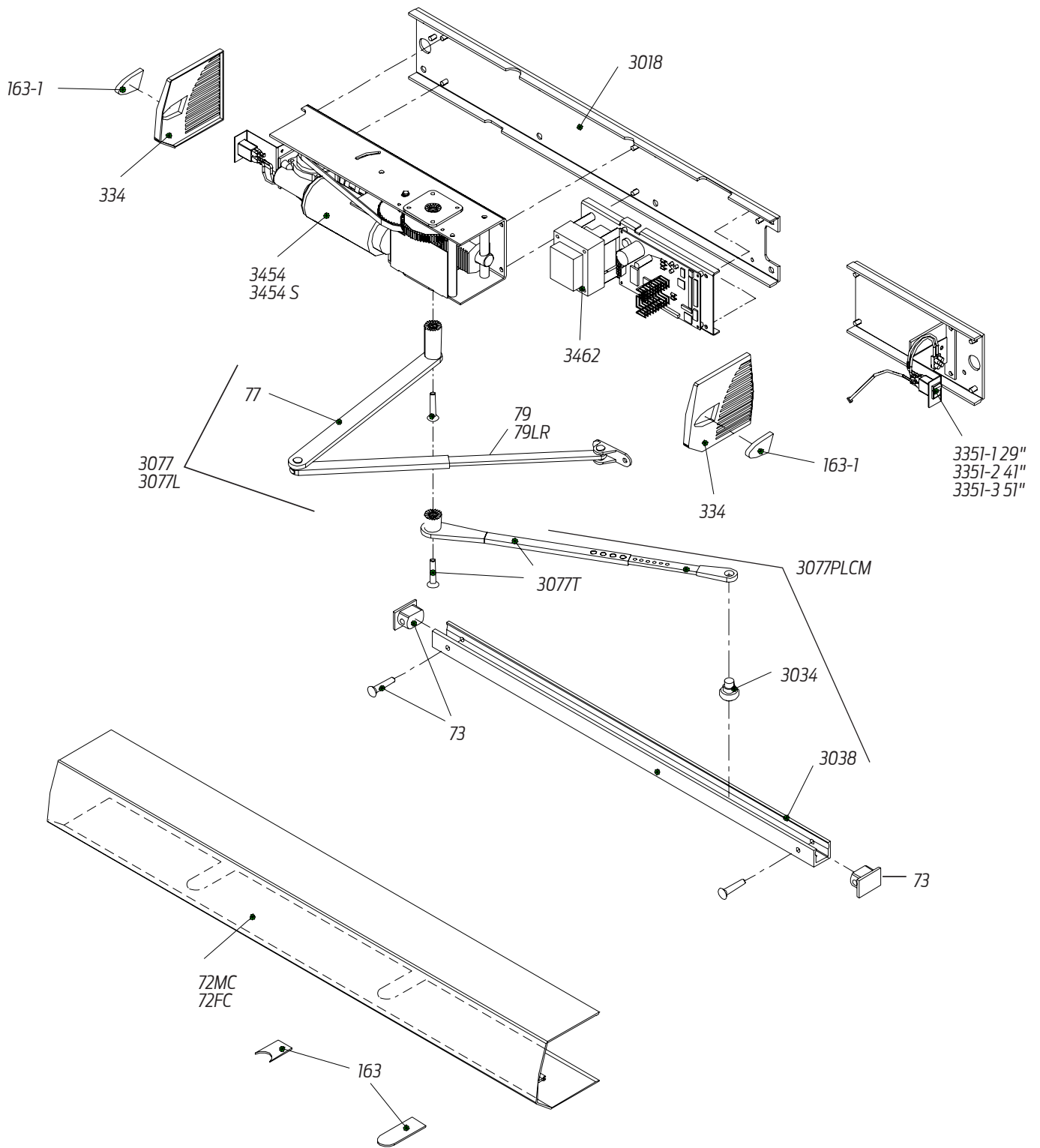

GLOSSARY OF ABBREVIATIONS

Arm Options

STD	- Standard Arm
REG	- Regular Arm
Rw/PA	- Regular Arm w/ Parallel Arm Shoe
Rw/62A	- Regular Arm w/ Auxiliary Parallel Arm Shoe
H	- Hold Open Arm
Hw/PA	- Hold Open Arm w/ Parallel Arm Shoe
HD	- Heavy Duty Arm (1460)
HDw/PA	- Heavy Duty Arm w/ Parallel Arm Shoe
LD	- Light Duty Arm
LDw/PA	- Light Duty Arm w/ Parallel Arm Shoe
LONG	- Long Arm
XLONG	- Extra Long Arm
HLONG	- Hold Open Long Arm
EDA	- Extra Duty Arm
EDAw/62G	- Extra Duty Arm w/ Thick Hub Shoe
HEDA	- Hold Open Extra Duty Arm
HEDAw/62G	- Hold Open Extra Duty Arm w/ 62G
CUSH (CNS)	- Cush -n- Stop Arm
HCUSH (HCNS)	- Hold Open Cush -n- Stop Arm
SCUSH (SCNS)	- Spring Cush -n- Stop Arm
SHCUSH (SHCNS)	- Spring Hold Open Cush -n- Stop Arm
SF	- Swing Free Arm (4310ME)
DE	- Double Egress Arm
FL	- Fusible Link Arm

Cylinder Options

STD	- Standard Cylinder
DEL (DA)	- Delay Action Cylinder
AVB	- Advanced Variable Backcheck
B80	- Bypass 80 Degree ME Cylinder
B140	- Bypass 140 Degree ME Cylinder
TEL	- Telephone Cylinder (4010/4020/4110)

Cover Options

STD	- Standard Plastic Cover
MC	- Metal Cover
FC	- Full Cover (1460)
DS (DS1)	- Designer Series Cover (1460)

Track Options

STD	- Standard Track
H	- Hold Open Track
BUMPER	- Track with Bumper
HBMP	- Hold Open Track with Bumper

Fastener Pack Options

WMS	- Wood & Machine Screws
TBWMS	- Thru-Bolt, Wood & Machine Screws
SRT	- Self Reaming & Tapping Screws
TBSRT	- Thru-Bolt, Self Reaming & Tapping Screws
TORX	- TORX Machine Screws
TBTRX	- Thru-Bolt, TORX Machine Screws

Finishes

AL	- Aluminum
DKBRZ	- Dark Bronze
BRASS	- Brass
LTBRZ	- Light Bronze
STAT	- Statuary
BLACK	- Black
MTLPC	- Bright Metallic
RAL	- Custom Finish Designation (RAL xxxx)
ANCLR	- Anodized Clear
ANDKB	- Anodized Dark Bronze

Swing Operator Terms

SF	- Standard Force Motor Gearbox
SC	- Standard Controller
POS	- Positive Mechanical Stop
BKY	- Breakaway Stop

Miscellaneous Terms

L	- Long
LR	- Long Rod
ELR	- Extra Long Rod
B80 or B140	- Bypass (Fire/Life Safety)
SRI	- Special Rust Inhibitor
SE	- Single Point Electronic (Fire/Life Safety)
ME	- Multi-Point Electronic (Fire/Life Safety)
PAH	- Parallel Arm Holder (PAH60)
ES	- Electric Strike (Control Boxes)
S (SEQ)	- Sequential (Control Boxes)
TJ	- Top Jamb
PA	- Parallel Arm
18G	- Flush Ceiling
T	- Track
DPS	- Door Position Switch (2210DPS)
FP	- Fire Protection Fluid

Header Options

Part	Extrusion (36" to 188") No Prep	Single Door* (36" to 49") Prepped	Door Pair (50" to 98") Prepped	Double Door Header** Prepped	Gearbox Brackets Included	Angle Brackets Included	End Caps Included	Filler Plates Included	Stop Prep*** Included
-572	X								
-572HL		X	X						
-572HL/S		X	X						X
-572DD				X					
-572DD/S				X					X
-3572HL		X	X		X	X	X	X	
-3572HL/S		X	X		X	X	X	X	X
-3572DD				X	X	X	X	X	
-3572DD/S				X	X	X	X	X	X

*2810, 9530 or 9540 only

**2850, 2860, 9550 or 9560 only

*** 2810, 2850 or 2860 only

A library of common wiring diagrams are available at no-charge for use in single and double door applications utilizing various configurations of Allegion door hardware products. These diagrams and much more can be accessed through our Knowledge Center tool at <http://kc.allegion.com/>, simply click on the link Common wiring diagrams.

Custom Wiring Diagrams

When common wiring diagrams do not meet the needs of the job requirements, Allegion offers a service to purchase custom wiring diagrams. All custom wiring diagrams include a point-to-point drawing, a riser diagram, and a detailed theory of operation. Custom wiring diagrams fall into two categories; Standard and Complex.

- Standard drawings: All Allegion products with a single opening and a basic theory of operation. These drawings will be quoted a NET \$250 for each drawing
- Complex drawings: Generic contacts, 3rd party components, complex relay logic, timer circuit logic, any other additional advanced logic. Drawings that fall under this type will receive a NET quote depending on the time required to complete the drawings at an hourly rate of \$200/hour with a \$250 minimum NET

How to Request a Quote for a Custom Wiring Diagram

- Custom wiring diagrams can only be ordered by and shipped to current Allegion Channel Partners
- Wiring Diagram Request Forms can be obtained by:
 - Sending an email request to Wiring.Diagram.Request@allegion.com
 - Using the online Distributor Portal under; My Support / Orders & Invoicing
 - Using the form located on the following page
- Once completed, email the completed request form to Wiring.Diagram.Request@allegion.com for processing
 - Be sure and include the following information to prevent delays to the request:
 - All supporting documentation for non-Allegion products
 - Hardware list with complete part numbers
 - Detailed Theory of operation for all openings
- Upon receipt the custom wiring coordinator will review and clarify the request as needed
- Once all clarifications are resolved a QUOTE#, NET pricing, and lead time will be assigned and communicated to the requestor within 1 business day
- QUOTE# is valid for 90 days
- A purchase order with the QUOTE# must be received for the wiring diagrams to be produced
 - Send the completed PO to Wiring.Diagram.Request@allegion.com
- Lead time is generally 2-3 weeks from time PO is received, more complex requests will have longer lead times
- Changes to the original request after a quote approval may incur additional charges and affect lead time
- Completed custom wiring diagrams will be emailed to the requestor

Notes

Wiring Diagram Request Form



ALLEGION™

Must be a Schlage Electronics, LCN, or Von Duprin Dealer

=====
Date ___/___/___ Project Name _____

Dealer/Distributor _____

Account # _____ Dealer Contact Name _____ Phone ____-____-____

=====
Provide a Primary Technical Contact _____ Phone ____-____-____
=====

Provide/Attach the Following

- All supporting documentation for all non-Allegion products.
 - Included hardware list with complete part numbers.
 - Detailed Theory of Operation for all openings.

Additional information that helps expedite the project:

Door Number; Door Size; Door Material;
Fire Rated Opening; Single/Pair; Double Egress; Interior/Exterior;
Interlocked Opening; Basic Floor Plan/Traffic Flow

=====
E-mail completed form and supporting documentation to

Wiring.Diagram.Request@allegion.com

Phone: 877-671-7011

LCN Limited Warranty

Subject to the terms and conditions of this limited warranty, Schlage Lock Company, LLC (the "Company") extends a limited warranty against defects in material and workmanship for its LCN branded product(s) identified in the Product Table below ("Products") as installed in the original location.

This limited warranty applies to Products purchased on or after **March 3, 2014**.

Product Table

4000 Series	30 Years
4050 Series	25 Years
1460 Series	30 Years
1450 Series	25 Years
1260 Series	20 Years
1250 Series	15 Years
Concealed, High Security (except 2210DPS)	15 Years
Automatic Operators; SE, ME, HSA, SEH Series; SEM Magnets; 2210 DPS (includes both electronic and mechanical components)	2 Years

Term: The limited warranty period for Products is as stated in the Product Table above. The "Commencement Date" for a limited warranty period shall be the date of Company's delivery to the original purchaser of the Products. Proof of Product purchase may be required by Company to confirm the Commencement Date.

What Company will do: Company may require proof of Product purchase in order to provide coverage under this limited warranty. As Company's only responsibility and user's only remedy under this limited warranty, Company will furnish a replacement Product upon receipt and confirmation by Company, in its sole opinion, that the Product has, in fact, failed due to a manufacturing defect under normal use and maintenance. In the event a replacement Product cannot be provided, Company will either provide a suitable replacement Product or a refund in the amount of the original purchase price.

What is not covered: The following costs, expenses, and damages are not covered by the provisions of this limited warranty: (i) labor costs including, but not limited to, such costs as removal and installation of Product; (ii) shipping and freight expenses required to return Product to Company; (iii) failures, defects, or damage caused by any third party product or service; (iv) any other incidental, consequential, indirect, special and/or punitive damages, whether based on contract, warranty, tort (including, but not limited to, strict liability or negligence), patent infringement, or otherwise, even if advised of the possibility of such damages.

The provisions of this limited warranty do not apply to Product that is: (i) not the proper size for the application for which the Product is used; (ii) not installed in accordance with Company's published Product installation instructions; (iii) installed with improper parts and/or incorrect parts (NOTE: It is recommended that Product be installed with LCN fasteners provided with Product); (iv) improperly stored, maintained, or operated; (v) modified, repaired, or altered in Company's sole opinion, in any manner, without the express written consent of Company; (vi) used for purposes for which the Product is not designed or intended; (vii) subjected to misuse, abuse, negligence, or accident; or (viii) subjected to improper temperature, humidity, or other environmental conditions.

Note: 900/7900 Series compressors are not manufactured by Company and are excluded from coverage under this limited warranty. For more information, parts, or repairs concerning the compressors, contact the compressor manufacturer directly at (269) 926-6171.

Additional Terms: This limited warranty is in lieu of all other warranties, express or implied. Company does not authorize any person to create for it any obligation or liability in connection with Product. Company's maximum liability hereunder is limited to the original purchase price of the Product. No action arising out any claimed breach of this limited warranty by Company may be brought by the user more than one (1) year after the cause of action has arisen.

How local law applies: This limited warranty gives you specific legal rights, and you may also have other rights as permitted by law. Some local laws do not allow limitations on how long an implied warranty lasts or the exclusions or limitation of incidental or consequential damages so the limitations or exclusions provided herein may not apply to you.

Program and Warranty Claims: If Product is to be claimed to be defective under this limited warranty, contact Customer Care at (877) 671-7011.

Note: Please contact LCN Customer Care prior to returning any product back to the factory. You will need prior authorization and an RMA for your return.

About Allegion

Allegion (NYSE: ALLE) creates peace of mind by pioneering safety and security. As a \$2 billion provider of security solutions for homes and businesses, Allegion employs more than 8,000 people and sells products in more than 120 countries across the world. Allegion comprises 27 global brands, including strategic brands CISA®, Interflex®, LCN®, Schlage® and Von Duprin®.

For more, visit www.allegion.com

KRYPTONITE ■ LCN ■  ■ STEELCRAFT ■ VON DUPRIN