

9000RA ADJUSTABLE SERIES HOLDERS & STOPS

SURFACE MOUNT

- 9010RA HOLD-OPEN
- 9020RA STOP

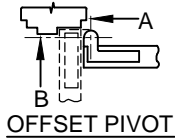

OFFSET PIVOT

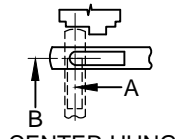

CENTER HUNG

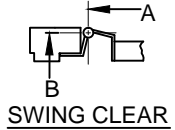

SWING CLEAR

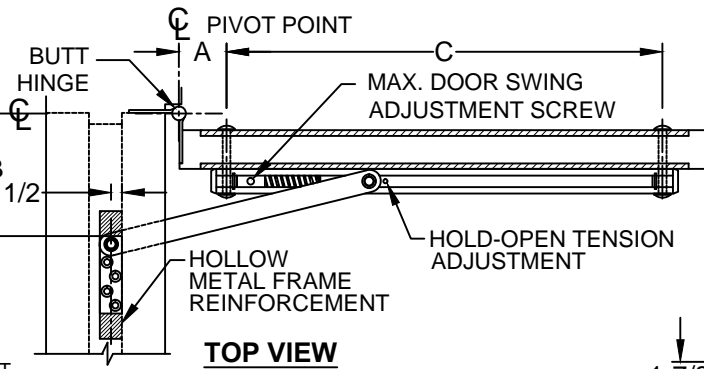

TOP VIEW

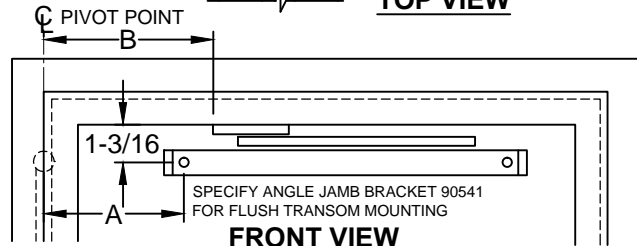

FRONT VIEW

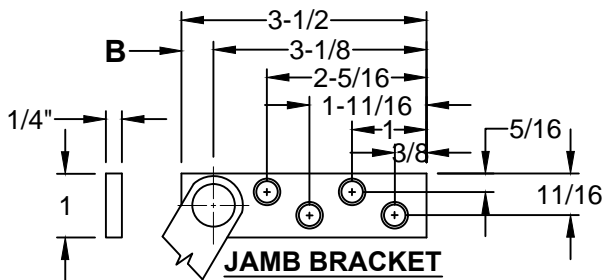

JAMB BRACKET

A = ϵ OF PIVOT POINT TO ϵ OF FIRST SEX BOLT.
 B = ϵ OF PIVOT POINT TO START OF JAMB BRACKET
 C = ϵ OF FIRST SEX BOLT TO ϵ OF SECOND SEX BOLT

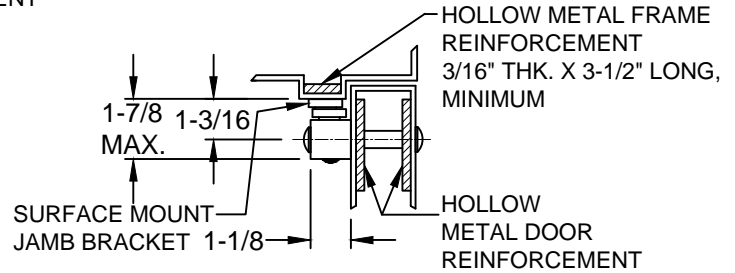

SINGLE ACTING DOOR

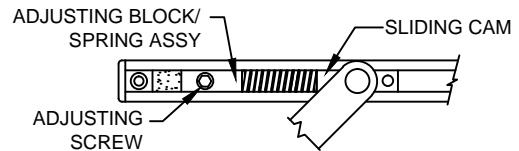

CHANGING MAXIMUM DEGREE OF DOOR SWING:

- LOOSEN THE ADJUSTING SCREW
- OPEN OR CLOSE DOOR TO THE REQUIRED DEGREE.
- MOVE THE ADJUSTING BLOCK/SPRING ASSEMBLY UNTIL THE SPRING HITS THE SLIDING CAM.
- TIGHTEN THE ADJUSTING SCREW.

NOTES:

1. REVERSIBLE/ NON - HANDED
 2. FOR SINGLE ACTING DOORS ONLY
 3. ALL DRILLING & TAPPING TO BE DONE IN FIELD.
 4. ALWAYS REQUEST LATEST TEMPLATE/ DRAWING FOR NEW INSTALLATIONS.
 5. ALL DIMENSIONS ARE IN INCHES.
 6. DRAWING IS NOT TO SCALE
- * BUTT HINGES ONLY

SCREW DETAIL

	QTY	WOOD	METAL
JAMB	4	• #14 x 1-1/2" FLAT HEAD WOOD SCREW	• 1/4-20 x 3/4" FLAT HEAD MACHINE SCREW
DOOR	2	• 5/16-18 x 2" TRUSS HEAD MACHINE SCREW • 1/2" DIA. SEX BOLT	

DOOR THICKNESS	MODEL NUMBER	FRAME OPENING	BUTT HINGE, 3/4" OFFSET PIVOT & SWING CLEAR			CENTER HUNG		
			A	B	C	A	B	C
1-3/4" THRU 2-1/4"	● 9013RA ● 9023RA	24" to 32"	2-7/16*	5-3/16*	17-5/16*	-	-	-
	● 9014RA ● 9024RA	32-1/16" to 40"	5-1/2	7	20-1/16	6-11/16	6-7/16	20-1/16
	● 9015RA ● 9025RA	40-1/16" to 48"	7-5/8	9-3/8	23-15/16	7-15/16	9-7/8	24



www.abhmfg.com
 E-mail: abhinfo@abhmfg.com
 Architectural Builders Hardware Mfg., Inc.
 1222 Ardmore Ave., Itasca, IL 60143
 630.875.9900; FAX 800.9FAXABH (932.9224)

©2017 ABH Mfg., Inc.
 printed in USA

9000RA

PAGE 1 OF 1
 REVISED 12-15-17

9000RA-01.DWG