



1800 Series Flatbar Exit Devices



ACCENTRA
ASSA ABLOY

ASSA ABLOY is transitioning the Yale Commercial brand to ACCENTRA. This affects only the brand name; the products and product numbers will remain unchanged. Prior to May 20, 2024, products may be shipped either as Yale Commercial brand or ACCENTRA brand. Products shipping after May 20, 2024, will be branded ACCENTRA.

Table of Contents



Contents

Introduction	3
Benefits & Features	4
Finishes	5
How to Order	6
1800(F) Rim	7
1810(F) Surface Vertical Rod	8
Trim Designs	9-12
Functions	13
Applications	14
Cylinders	15-16
Strikes	17
Accessories	18
Mullions	19-20
Dimensions	21
Technical Specifications & Listings	22

1800 Flatbar Exit Devices

Yale 1800 Series Exit Devices are the ideal choice for economy commercial applications where you need consistent quality, dependability and ease of use and installation. The 1800 Series is ANSI/BHMA certified Grade 1, with durable construction and versatile mounting applications, making it ideal for a variety of facilities.





Offering strength and durability in one reliable product after another, Yale Works for YouSM.

Introduction

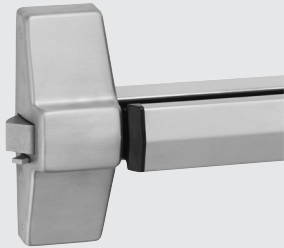

Yale® Commercial Solutions offers innovative and reliable products to solve the challenges of commercial, retail, hospitality, assisted living, mixed-use, and multi-family properties. With over 150 years of door hardware experience, Yale's expertise extends beyond products to people - and provides the service and support you expect.

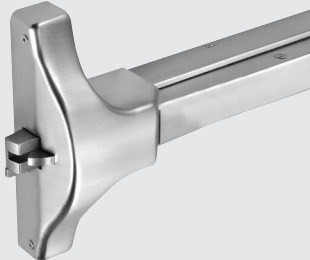
Featuring durable products to meet all your facilities' requirements - and the quality you expect from a leader in the hardware industry. Yale works for youSM.

Yale Exit Devices			
7000 Series	6000 Series	2100 Series	1500 Series
			
<ul style="list-style-type: none"> • Ideal for facilities that require durability and innovation to meet their security needs • Wide & Narrow Stile Applications • Rim, SquareBolt, Mortise, SVR & CVR • Mechanical & Electro-Mechanical Functions • Available with Motorized Electric Latch Retraction • Constructed with high quality steel and heavy-duty components • 16 Standard finishes including BSP (Black Suede Powder Coat) • ANSI/BHMA Certified Grade 1 • 5 Year Warranty and Two-Year Limited Warranty on Electronic Components • UL Rated for Panic & Fire, Windstorm Rated Options (refer to local codes) 	<ul style="list-style-type: none"> • Ideal for facilities that require modern form and full functionality to meet their life safety needs • Wide & Narrow Stile Applications • Rim, Squarebolt, CVR, SVR & Mortise • Mechanical & Electro-Mechanical Functions • Aluminum rail assembly with Architectural Metals • Solid Cast Flush End Cap • ANSI/BHMA Certified Grade 1 • UL Rated for Panic & Fire • 10 Year Warranty 	<ul style="list-style-type: none"> • Ideal for commercial applications and budget conscious end users • Narrow & Wide Stile Applications • Rim, Squarebolt, CVR & SVR • Mechanical Functions • ANSI/BHMA Grade 1 Certified • UL Rated for Panic & Fire • Architectural & Painted Finishes • 3 Year Warranty 	<ul style="list-style-type: none"> • Ideal for renovation projects where historical preservation is the desired look • Wide Stile Applications • Rim, CVR, SVR & Mortise • ANSI/BHMA Certified Grade 1 • UL Rated for Panic & Fire • Architectural & Painted Finishes • 1 Year Warranty

Benefits & Features



Benefits

- **Tough:** Sturdy construction is ideal for meeting the rigors of demanding industry environments
- **Versatile:** Available in standard painted as well as architectural finishes for both front and back of house applications
- **Economical:** Works for a variety building projects, regardless of budget
- **Strong & Durable:** ANSI/BHMA Grade 1 Certification ensures long life and reliability

Features

- High-grade steel components offer superior protection against wear & tear
- Available in a variety of functions and finishes for any application
- ANSI/BHMA Grade 1 certified 
- UL/cUL listed for fire rated doors
- One year warranty

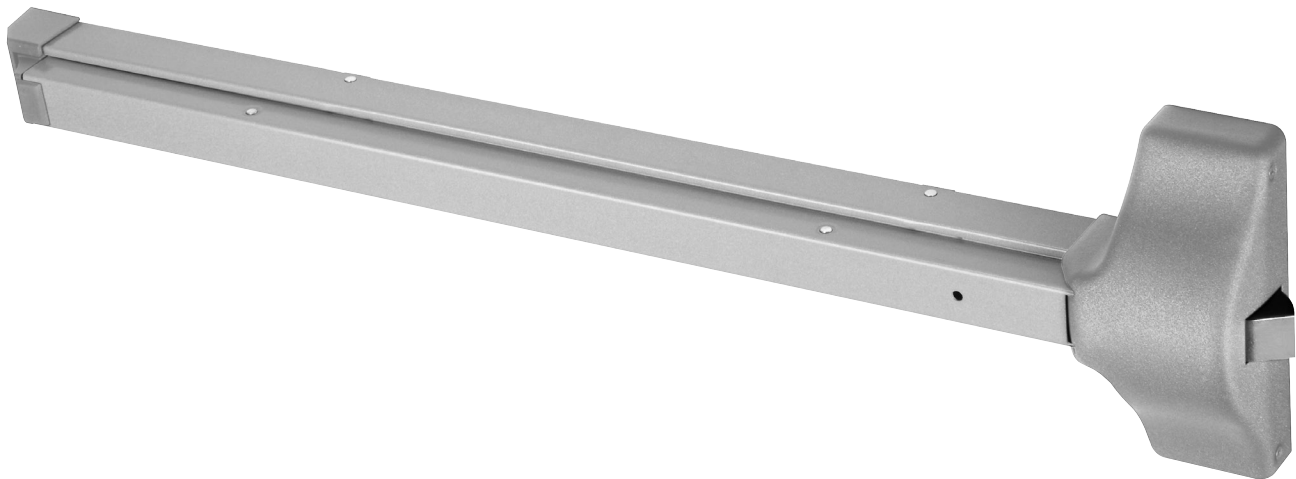

Finishes



ANSI/BHMA Code Finish Description		
626* Satin Chrome Plated (Trim Only)	630* Satin Stainless Steel (Trim Only)	689 Aluminum Painted

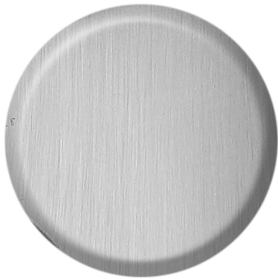

691 Light Bronze Painted	693 Black Painted	695 Dark Bronze Painted
------------------------------------	-----------------------------	-----------------------------------



WSP White Suede Powder Coat



*Finish available with MicroShield® antimicrobial coating, additional finishes by special application. Consult factory for availability.

MicroShield coating may vary finish color from architectural standards. MicroShield is not intended as a substitute for traditional infection control programs such as hand hygiene or use of disinfectants. Coated products must still be cleaned to ensure the surfaces will be free of destructive microbes. Yale makes no representations or warranties, express or implied, as to the efficacy of MicroShield.

How to Order



18	1	X	0	Suffix	-XX	Outside Trim	Finish	Other Info
		Third Digit: "0" - Rim Device "1" - SVR Device		Trim Suffix: No Suffix - Panic label "F" - Fire label	Size: (DOW=Door Opening Width) "36" - 30" to 36" (76cm to 91cm) "42" - 36" to 42" (91cm to 107cm) "48" - 42" to 48" (107cm to 122cm)	Trim Model Number See pages 9-12	626 689 691 693 695 WSP	Other Information: Door Hand - RHR or LHR (SVR or Lever Escutcheon Trim only). Devices are field reversible. SN-134, 1/4-20 Sex Nuts (pack of 4). SN-104, 10-24 Sex Nuts (pack of 4). Door Thickness: over 1-3/4" (45mm). Rod Extensions: (quantity) 2010-2 (quantity) 2010-6 (quantity) 2010-12 Shim Kits: (quantity) 223 (quantity) 224 Optional Strike (page 17) Removable Mullion: M200 (Panic) M200F (Fire) KRM200 (Panic) KRM200F (Fire) M200SM, Panic Exit KRM200SM, Panic Exit Factory Keying Bottom Pullman Latch (SVR Devices)

Notes:

- It is recommended that exit devices and trim for the same opening be ordered together.
- Standard product is for 1-3/4" (44mm) reinforced metal doors.
- Accessories detached from the device and trim should be specified separately.
- 626 finish offered for 440F series trim only.

1800(F) Rim



The 1800(F) is a rim exit device to be used with single doors or pairs of doors constructed of metal, wood or composite materials. The 1800(F) can be paired with a wide variety of trims to meet many applications.

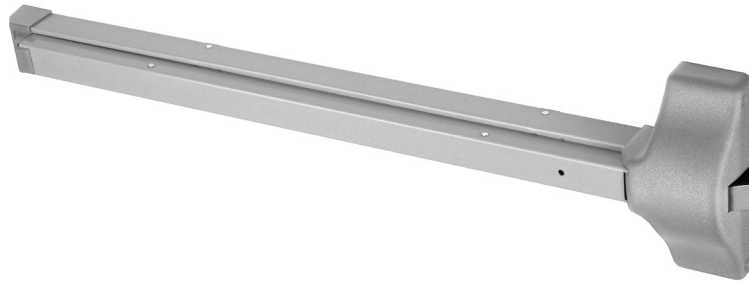

Certification/Compliance

UL/cUL Listed: FVSR/FVSR7 - Panic hardware
GXHX/GXHX7 - Fire exit hardware (F)
(up to 4' x 8' single, 8' x 8' pairs, 3 hr.)

ANSI/BHMA Certified: A156.3 Type 1, Grade 1



Features

- Designed for wide stile doors
- Non-handed for easy installation
- Steel interlock "E" bracket maintains door-to-mullion relationship in fire-labeled devices

Applications

- Single swing doors
- Pairs of doors (mullion required)
- Metal, wood or composite door materials

Specifications

Door Opening Width	-36 for 30" - 36" (76cm - 91cm) doors -42 for 36" - 42" (91cm - 107cm) doors -48 for 42" - 48" (107cm - 122cm) doors
Door Thickness	1-3/4" (44mm) standard. Refer to page 18 for other door thicknesses
Minimum Stile Width	4-1/2" (114mm)
Projection	2-1/2" (64mm) active, 1-3/4" (44mm) depressed
Strike	757F, 793 optional (double door application)
Trims	210F series utility trim, 420F series escutcheon trim, 440F series rose trim
Dogging	Hex key dogging supplied standard on panic devices
Finishes	689, 691, 693, 695
Options	Shim Kit #223, Sex Nuts and Bolts
Warranty	1-year limited

1810(F) Surface Vertical Rod



The 1810(F) is a surface vertical rod exit device to be used on metal, wood or composite pairs of doors up to 8' where two-point latching is desired.

Certification/Compliance

UL/cUL Listed: FVSR/FVSR7 - Panic hardware
GXHX/GXHX7 - Fire exit hardware (F)
(up to 4' x 8' single, 8' x 8' pairs, 3 hr.)

ANSI/BHMA

Certified: A156.3 Type 2, Grade 1

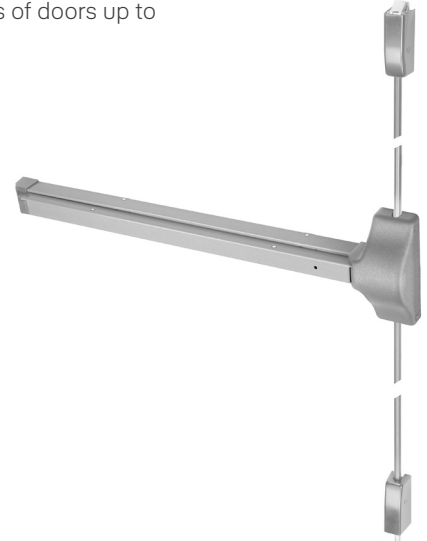

Features

- Designed for wide stile and flush doors
- Handed, specify hand (field reversible)
- Positive action linkage on a deadlocking top Pullman bolt
- Simultaneous direct pull bottom deadbolt
- When unlatched, device keeps both bolts retracted until door is shut.

Applications

- Pairs of doors
- Double egress
- Metal, wood or composite door materials

Specifications

Door Opening Width	-36 for 30" - 36" (76cm - 91cm) doors -42 for 36" - 42" (91cm - 107cm) doors -48 for 42" - 48" (107cm - 122cm) doors
Door Opening Height	Standard door height 7' (213cm), with the device centerline at 39-15/16" (101cm) from floor Optional heights up to 8' (244cm) by using rod extensions
Door Thickness	1-3/4" (44mm) standard. Refer to page 18 for other door thicknesses
Minimum Stile Width	4-1/2" (114mm)
Projection	2-1/2" (64mm) active, 1-3/4" (44mm) depressed
Strike	Top: Roller type 791. Bottom: Flush mounted 790. 794 floor strike optional (threshold openings), 702 optional (Bottom Pullman Latch)
Trims	210F series utility trim, 420F series escutcheon trim, 440F series rose trim
Dogging	Hex key dogging supplied standard on panic devices
Finishes	626, 689, 691, 693, 695
Options	Shim Kit #224, Sex Nuts and Bolts, Bottom Pullman Latch (panic only)
Warranty	1-year limited

Trim Designs



Escutcheons

420F Series



Projection: 2-13/32" (61mm)

Roses

440F Series



Projection: 3-1/2" (89mm)

Plate Trim

210F Series



Standard Levers

AU Augusta 	MO Monroe 	PB Pacific Beach 
 Projection: 2-5/16" (59mm)	 Projection: 2-3/16" (71mm)	 Projection: 2-3/4" (70mm)



420F Series Wide Escutcheon Trim



- Certified ANSI/BHMA A156.3, Grade 1. **BHMA CERTIFIED**
- Through-bolted. 1-3/4" (44mm) door standard. For doors thru 2-1/4" (57mm) or shim-mounted devices, specify on order.
- Dimensions: 2-1/2" x 9-1/2" x 1/4" (64mm x 241mm x 6mm).
- Cylinders not included. For rim cylinders, see pages 15-16.
- Lever styles: AU, MO, PB
- Finishes: 630, 689, 691, 693, 695.
- 1-year warranty.
- Ordering Example: PB428F x LHR x 689.

Application	Cylinder	Exit Only Blank Plate	Nightlatch	Classroom/ Storeroom	Nightlatch	Dummy Free Wheeling	Passage	Dummy Rigid Lever
1800(F) 1810(F)	Rim	420F	421F*	426F	427F*	428F	428F	429F
ANSI		01	03	08/09	03	02	14	02

***Not recommended for use with 1810(F) surface vertical rod exit devices.**
Note: 09 and Free Wheeling 02 achieved with single trim modification at installation.

440F Series Rose Trim



- Certified ANSI/BHMA A156.3, Grade 1. **BHMA CERTIFIED**
- 440F rose trim for stock doors (161 Prep).
- 1-3/4" (44mm) door standard. For doors thru 2-1/4" (57mm) or shim-mounted devices, specify on order.
- Cylinders included, accepts component cylinders. See pages 15-16.
- Finishes: 626, 689, 691, 693, 695.
- "B" trim prefix – Lever trim accepting small format interchangeable cores (SFIC). Specify 6- or 7-pin.
(Example: B-AU446F)
- 2-year warranty.
- Ordering example: AU446F x RHR x 693.

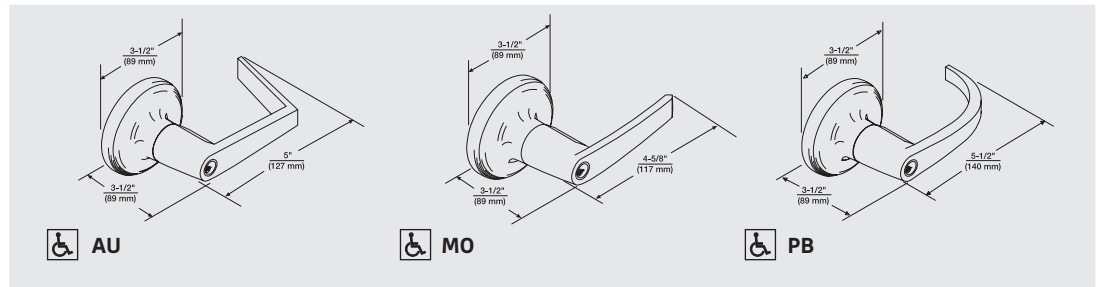

Application	Nightlatch Access by Key	Classroom	Dummy Trim Free Wheeling Lever	Passage Lever	Dummy Trim Rigid Lever
1800(F) 1810(F)	441F*	446F	448F	448F	449F
ANSI	03	08	02	14	02

*Not recommended for use with vertical rod exit devices.

Trim Designs



210F Series Trim



- Thrubolted. 1-3/4" (44mm) door standard. For doors thru 2-1/4" (57mm) or shim-mounted devices, specify on order.
- Plate Dimensions: 3-1/2" x 3-3/4" x 3/32" (89mm x 95mm x 2mm).
- Finger Pull Dimensions: 3-1/2" x 6-3/4" x 1/8" (89mm x 171mm x 3mm).
- Cylinders not included. For rim cylinder options, see pages 15-16.
- Finishes: 689, 691, 693, 695.
- 1-year warranty.

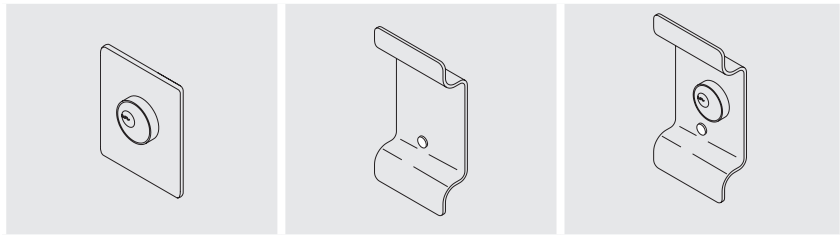













Application	Cylinder	Nightlatch Access by Key	Dummy Trim Pull Plate	Nightlatch Cylinder x Pull
1800(F) 1810(F)	Rim	213F*	214F	217F*
ANSI		03	02	03

***Not recommended for use with 1810(F) surface vertical rod exit devices.**

Functions





ANSI types 1 (Rim) and 2 (Surface Vertical Rod) exit device requirements are met (or exceeded) by 1800(F) and 1810(F) respectively. Any of these exit devices may be used with any of the trim on the following chart. Trims are charted according to ANSI trim function and illustrations show typical function features, rather than pictorial renderings of the trims listed. Specific trim details are shown on pages 9-12.

Trim	Device (ANSI)	Rim (Type 1)		SVR (Type 2)	
	Options	1800(F) (Page 7)		1810(F) (Page 8)	
ANSI	Function				
01	Exit Only, No Trim/Exit Only, Blank Plate		420F		420F
02	Pull to Open (Dummy Trim)		214F 448F* 428F* 449F* 429F		214F 448F* 428F* 449F* 429F
03	Key Retracts Latchbolts (NL)		213F 427F 217F 441F 421F		213F 427F 217F 441F 421F
08	Entrance by Lever (Key Locks/Unlocks Lever)		426F 446F		426F 446F
09	Key Unlocks Lever (Key Removable When Locked)		426F*		426F*
14	Lever Always Active (Passage)		428F 448F		428F 448F

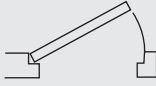

***Trims marked with an asterisk on the Application Chart require an easy field change to adapt them for the charted function.**

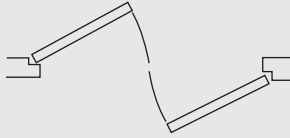

Single Door	Pairs of Doors
 <p>Rim Exit Device</p> <ul style="list-style-type: none"> • ANSI/BHMA A156.3 Type 1 • Easy installation • Flush or wide stile metal, wood or composite doors • Non-handed • Exit only or with entry trim 	 <p>One Rim - One Vertical Rod Exit Device</p> <ul style="list-style-type: none"> • An economic solution for light traffic openings • Flush or wide stile metal, wood or composite doors • Non-handed • Emergency exit only
Pairs of Doors with Center Mullion	Pairs of Doors or Double Egress Opening
 <p>Two Rim Exit Devices - One Removable Mullion</p> <ul style="list-style-type: none"> • ANSI/BHMA A156.3 Type 1 and Type 22 • Easy installation • Flush or wide stile metal, wood or composite doors • Non-handed • Exit only or with entry trim 	 <p>Two Surface Vertical Rod Exit Devices</p> <ul style="list-style-type: none"> • ANSI/BHMA A156.3 Type 2 • Two-point latch security • Flush or wide stile metal, wood or composite doors • Smoke control or fire exits • Two-way traffic control

Cylinders

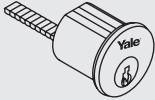
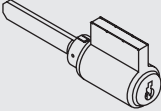

Illustration	Type	Model Number	Number of Pins
	Cylinder used for trim series 210F and 420F	1109	6
	Cylinder used for trim series 440F	1802	6
	Cylinder used for KRM200SM and KRM200(F)	2153	6

Keying

All cylinders furnished standard 6-pin, keyed random in Yale® PARA keyway, pinned to Yale .019" specification. Each cylinder furnished with two nickel silver keys.

Options



Cylinders available 0-bitted, keyed alike, master keyed or construction master keyed upon request.

Small Format Interchangeable Core (SFIC)

Model/Prefix	Description	Length	Number of Pins (Specify)		Ordering Example
			6-Pin	7-Pin	
B-	Prefix for cylindrical lever with SFIC prep. Less core. For use with 440F series trim.	—	—	—	B-AU446F x 693
K680	Rim SFIC housing only. For use with 210F and 420F series trim.	1-1/4"	X	—	AU426F x K680 x 1-1/4" x 693
		1-3/8"	X	X	
K660	Mortise SFIC housing only. For use with Key Removable Mullion.	1-1/4"	X	—	KRM200F x K660 x 1-1/4"
		1-3/8"	X	X	

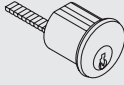
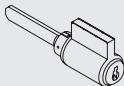
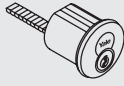

Competitor Keyway Cylinders/Cores

Illustration	Type	Model Number	Number of Pins
	Best® Keyway Core. Available keyed random, master keyed or uncombined. Specify keyway A, B, C, D, E, F, G, H, J, K, L or M.	A600	6 or 7
	Schlage® "C" Keyway Cylinder. For use with 210F and 420F series trim. Available 0-bitted or keyed random.	2109	6
	Schlage® "C" Keyway Cylinder. For use with 440F series trim. Available 0-bitted or keyed random.	2802	6
	Rim SFIC Cylinder. Includes Best Keyway Core. For use with 210F and 420F series trim. Available keyed random, master keyed or uncombined. Specify keyway A, B, C, D, E, F, G, H, J, K, L or M.	A640	6 or 7 Specify Length: 1-1/4" (6-pin only) 1-3/8" (6- or 7-pin)
	Mortise SFIC Cylinder. Includes Best® Keyway Core. For use with Key Removable Mullion. Available keyed random, master keyed or uncombined. Specify keyway A, B, C, D, E, F, G, H, J, K, L or M.	A620	6 or 7 Specify Length: 1-1/4" (6-pin only) 1-3/8" (6- or 7-pin)
	Schlage® "C" Keyway Cylinder. For use with Key Removable Mullion. Available 0-bitted or keyed random.	2553	6

Strikes



Rim Devices

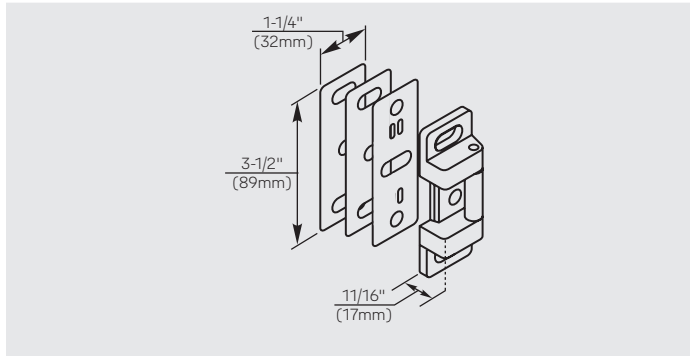

757F
Standard strike for 1800(F) devices. Supplied with #10-24 x 3/4" machine screws, two shims (each 1/16" thick), and one locking plate.

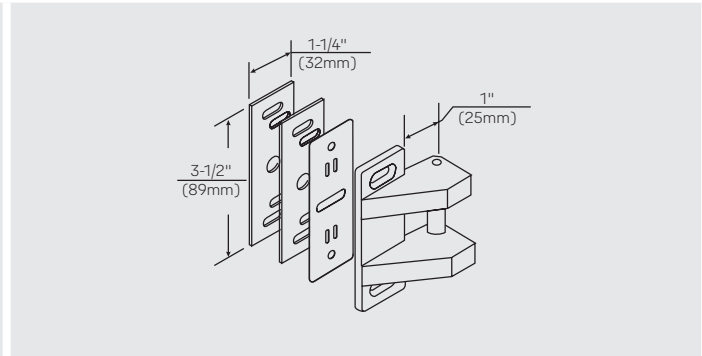

793
Optional strike for double door applications without a mullion. Supplied with #10-24 x 3/4" machine screws, two shims (each 1/16" thick), and one locking plate.

Vertical Rod Devices - Top Strikes

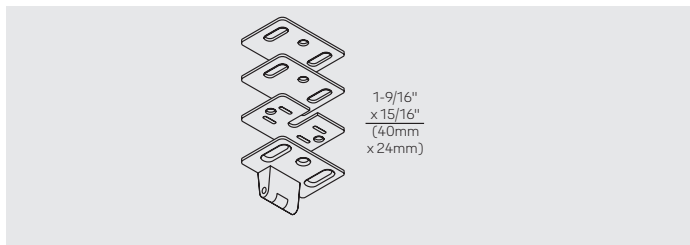

791
Standard top strike for 1810(F) devices. Supplied with #10-24 x 3/4" machine screws, two shims (each 1/16" thick), and one locking plate.

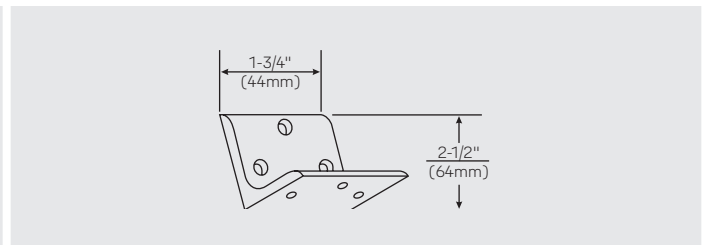

797
Optional bracket for mounting 791 top strike in flush transom opening. Supplied with 1/4-20 machine screws; SN-134 sex nuts, optional.

Vertical Rod Devices - Bottom Strikes

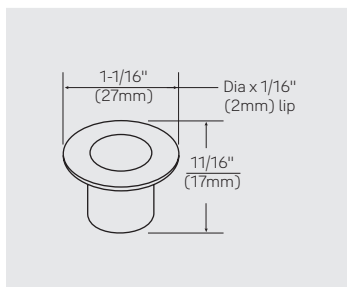

790
Standard bottom strike for 7110(F), 7120(F), 7160(F), 7170(F), 7210, 7220, 7210M(F), 7220M(F) series devices. Press in place.

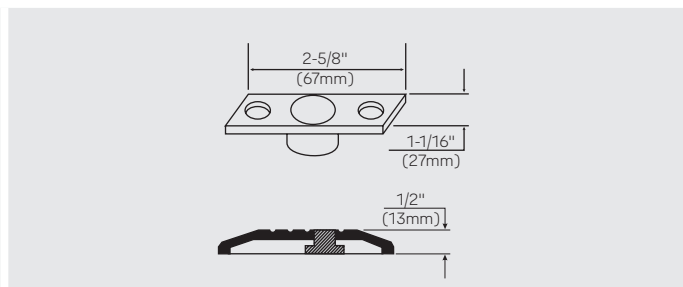

794
Optional bottom strike for fire openings using saddle thresholds or for flush floor mount. Must use for fire openings with 1/2" thresholds. Supplied with #10-24 x 1/2" machine screws and floor anchors.

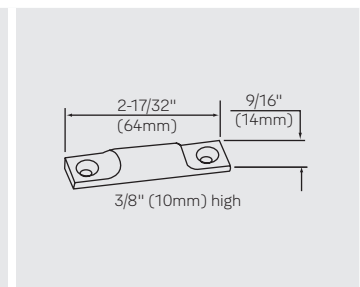

702
Optional bottom strike for bottom pullman latch option. Supplied with #8 x 8/32" combination screws.



Shim Kits

Shim kits are available for devices on doors with interfacing—molding. Each shim kit contains:

- 2 sets of 1/8" shims (shim up to 1/4")
- Longer fasteners
- Longer connecting bar for the trim
- Installation instructions

223 – Shim Kit for 1800(F) Series rim exit devices

224 – Shim Kit for 1810(F) Series surface vertical rod exit devices

Extension Rods

1810(F) surface vertical rod devices are supplied standard for 7' (213cm) standard. Rods may be field cut or used with extension rods for other heights. To order, specify:

Model Number	Length
2010-2	2" (51mm)
2010-6	6" (153mm)
2010-12	12" (305mm)

Specialty Fasteners

Sex Nuts:

Required for wood, composite or unreinforced metal doors. To order specify:

- SN-104 – pack of (4) 10-24 sex nuts for all fire rim exits
- SN-134 – pack of (4) 1/4-20 sex nuts for all devices

Wood Door Fasteners:

For solid core wood doors, permitted if pilot holes are used to install screws. Consult the factory for availability.

Torx® Security Screws available for factory product orders.

Long Tailpiece Kit

Long tailpiece kit for use with escutcheon series trim, up to 4-1/2" thick doors. Specify part number to order.

Door Thickness	Trim Type	Part Number
2" - 2-1/2"	420F Series Trim	81-9500-1665-000
2-1/2" - 3-1/2"	420F Series Trim	81-9500-1635-000
3-1/2" - 4-1/2"	420F Series Trim	81-9500-1636-000

Bottom Pullman Latch

Optional bottom Pullman latch available for panic-listed vertical rod exit devices. To order with devices, specify "BPL." 702 bottom strike required, see page 17.

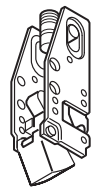

Mullions

M200(F) Removable Mullion

M200(F) steel mullions are for use with 1800(F) Series exit devices. Mullions may be field cut to fit opening. Gray paint finish.

- M200 panic rated.
Tubular steel, 2" x 3" (51mm x 76mm). Specify 7'2".
- M200F 3 hour fire rated.
Tubular steel, 2" x 3" (51mm x 76mm). Specify 7'2" or 10'1" (Fire rated up to 8').

Notes:

1. For 8' length Mullion must be order as M200F option and cut in the field to 8' size.

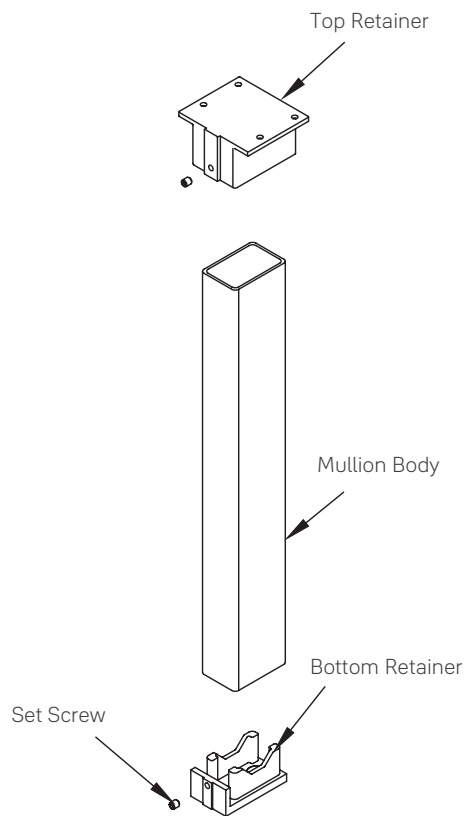

M200(F) Options

- **M203 Spacer Block**
Recommended for double rabbeted frames where the stop face width is less than the mounting hole spacing or for applications with 5-3/4" (146mm) or less door frames.

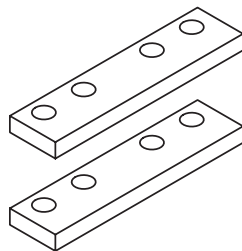

- **M204 Angle Bracket**
Recommended for any header configuration with less than 3" (76mm) of mounting surface.

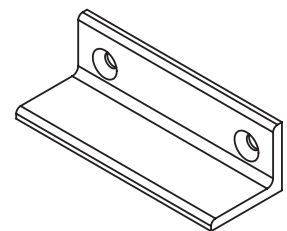

Mullions



KRM200(F) Keyed Removable Mullion (KRM)

Keyed removable mullions are for use with 1800(F) series exit devices. They are designed for simple removing when an unobstructed large opening is required and easy replacement and locking to maintain the integrity of the opening.

- KRM200 panic rated. Specify 7'2".
- KRM200F 1-1/2 hour fire rated. Specify 7'2" or 10'1" (Fire rated up to 8')

Notes:

1. For 8' length Mullion must be order as KRM200F option and cut in the field to 8' size.

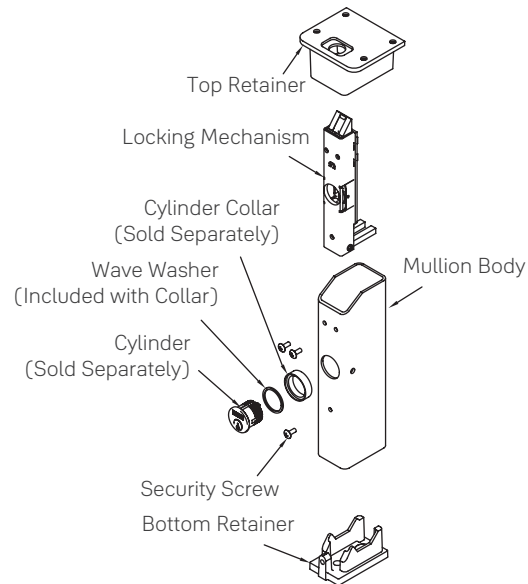

KRM Features

- Easy cylinder installation.
- Mullion automatically relocks when reinstalled without the use of the cylinder key.
- When ordering, add KR prefix to mullion, example: KRM200 and KRM200F.

Split Mullion

- Hassle-free transportation with a 30% smaller packaging size. Mullions may be field cut to fit opening. Gray painted finish. Available only in 8'. When ordering add suffix SM, example M200SM and KRM200SM

M200SM Standard

- Panic rated. Specify 8'
- Tubular steel, 2" x 3" (51mm x 76mm).

KRM200SM Key Removable Split Mullion

- Easy cylinder installation.
- Panic rated. Specify 8'
- Tubular steel, 2" x 3" (51mm x 76mm).

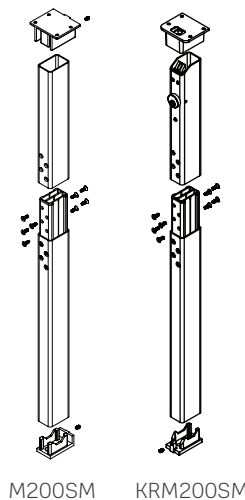

KRM Options

M203 Spacer Block

Recommended for double rabbeted frames where the stop face width is less than the mounting hole spacing or for applications with 5-3/4" (146mm) or less door frames.

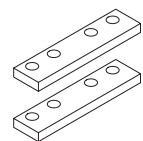

M204 Angle Bracket

Recommended for any header configuration with less than 3" (76mm) of mounting surface.

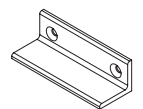

KRM Cylinders

As with any exit device trim, you must order a cylinder and collar if one is required. The Yale® keyed removable mullion accepts a mortise cylinder. Refer below and to pages 15-16 for details.

KRM Collars

Cylinder Model #	Length	Collar Requirement
2153 or 2553	1-1/4"	1765.312
A620 or K660	1-1/4"	1765.406
	1-3/8"	1765.563

Dimensions

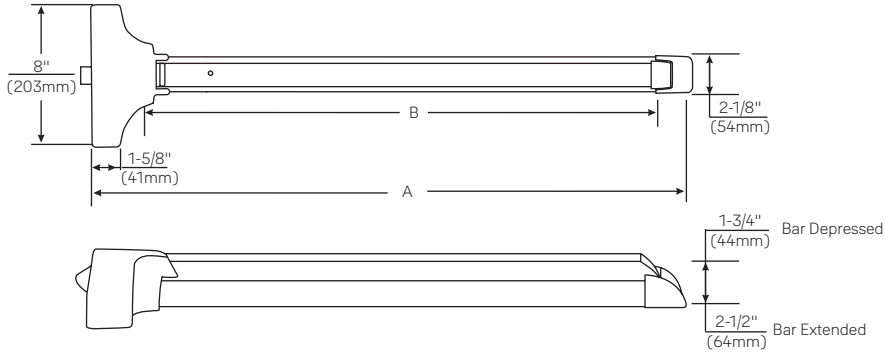

Device Size	"A"	"B"
36"	33" (84cm)	27" (69cm)
42"	39" (99cm)	33" (84cm)
48"	45" (114cm)	39" (99cm)



ANSI/BHMA

Certified ANSI/BHMA A156.3, Grade 1.



Fire Listings

1800 series exit devices are UL-cUL Listed for use on fire doors having a rating up to and including 3-hours.

Note: Any retrofit or other field modification to a fire rated opening can potentially impact the fire rating of the opening, and Yale Locks & Hardware makes no representations or warranties concerning what such impact may be in any specific situation. When retrofitting any portion of an existing fire rated opening, or specifying and installing a new fire-rated opening, please consult with a code specialist or local code official (Authority Having Jurisdiction) to ensure compliance with all applicable codes and ratings.

Free Wheeling Lever Trim

1800 series exit device lever trims feature the unique Free Wheeling lever mechanism. This Free Wheeling trim features a clutch mechanism which allows the lever to float down 60° when operated in the locked condition, greatly improving vandal resistance.

ISO 9001

Designed and manufactured under a certified ISO 9001 quality system.

Warranty

The 1800 series exit devices and escutcheon trim carry a three-year warranty. Cylindrical trims carry a two-year warranty.





Trusted every day

Phone

1-855-557-5078

Customer Service Email

customerservice.yale@assaabloy.com

Technical Product Support Email

techsupport.yale@assaabloy.com

Order Entry Email

orders.yaleus@assaabloy.com

Fax

1-800-338-0965

Website

www.yalecommercial.com

Contact Us

U.S.A.

Yale Locks & Hardware

Address: 225 Episcopal Road

Berlin, CT 06037-4004

Tel: 1-800-438-1951

Fax: 1-800-338-0965

yalecommercial.com

Canada:

ASSA ABLOY Door Security Solutions Canada

Address: 160 Four Valley Drive

Vaughan, Ontario L4K 4T9

Tel: 1-800-461-3007

Fax: 1-800-461-8989

assaabloydss.ca

International:

ASSA ABLOY Americas International

Tel: 1-905-821-7775

Fax: 1-905-821-1429

assaabloyai.com

MicroShield®

ASSA ABLOY Group companies offer MicroShield®, an anti-microbial coating for door hardware. MicroShield uses proven silver ion-based technology from Agion®, a leading provider of antimicrobial solutions, to stem the spread of bacteria and other microbes.

MicroShield® is a registered trademark of ASSA ABLOY Access and Egress Hardware Group, Inc.



The Agion antimicrobial is not intended as a substitute for good hygiene. Coated products must still be cleaned to ensure the surfaces will be free of destructive microbes. ASSA ABLOY makes no representations or warranties, express or implied, as to the efficacy of the Agion antimicrobial. A copy of the Agion warranty is available upon request. Agion is a registered trademark of Agion Technologies, Inc., Wakefield, MA, USA.

THE YALE BRAND, with its unparalleled global reach and range of products, reassures more people in more countries than any other consumer locking solution.

THE ASSA ABLOY GROUP is the world's leading manufacturer and supplier of locking solutions, dedicated to satisfying end-user needs for security, safety and convenience.

Yale Commercial is a business associated with ASSA ABLOY Access and Egress Hardware Group, Inc., an ASSA ABLOY Group company. Copyright © 2010-2024, ASSA ABLOY Access and Egress Hardware Group, Inc. All rights reserved. Reproduction in whole or in part without the express written permission of ASSA ABLOY Access and Egress Hardware Group, Inc. is prohibited. Patent pending and/or patent www.assaabloydss.com/patents.