



Installation Instructions

80-9303-2212-010 (06-09)

Non Hold Open & Hold Open Models

Note: Hold open models are not permitted to be installed in Listed fire door assemblies.

3040 & 3050 Slide Track Door Closers

PULL SIDE MOUNTED		PUSH SIDE MOUNTED	
Non Hold Open	Hold Open	Non Hold Open	Hold Open
3340ST, 3341ST, 3540ST, 3541ST	3350ST, 3351ST, 3550ST, 3551ST	P3340ST, P3341ST, P3540ST, P3541ST	P3350ST, P3351ST, P3550ST, P3551ST

- With or without "DL" suffix, delayed action closing feature.
- With or without "M" suffix, Metal Cover.
- **Sized Door Closers 3340/3540 & 3350/3550** have 50% power increase capability. Closer size 4 has the weakest power, closer size 6 has the strongest power.



The closing force for these series of door closers is adjustable from a size 1 to a size 6, as outlined in ANSI Standard A156.4. When these series of door closers are installed and adjusted to conform to ADA reduced opening force requirements (5 lbs max.) for interior doors, they may not have adequate closing

force to reliably close and latch the door. Power adjustments charted on Page 5 are recommended, where possible, to insure proper door control.

- **Multi-Sized Closer 3341/3541 & 3351/3551** can be adjusted from size 1 thru 6.

CAUTION

An incorrectly installed or improperly adjusted door closer can cause property damage or personal injury. These instructions should be followed to avoid the possibility of misapplication or misadjustment.

For Use on Doors with 4½" or 5" (115-127mm) Wide Butt Hinges

Installation Type

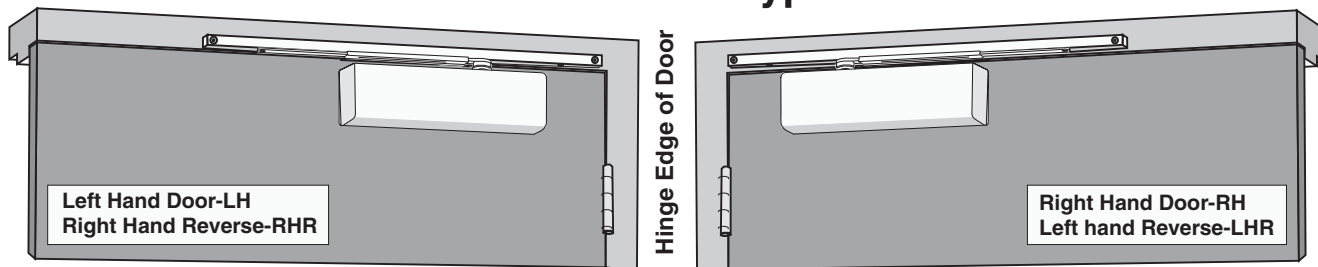

Pull (Hinge) Side Mounted

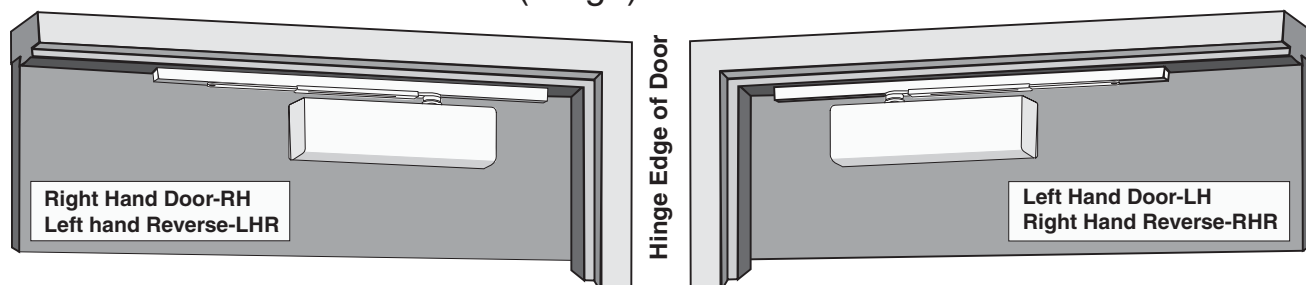

Push (Stop) Side Mounted

3050 Series Hold Open Units Are Not Permitted To Be Installed In Fire Door Assemblies

- Maximum pull side frame reveal is 1/8" (3mm).
- Minimum frame face for pull side is 1-3/8" (35 mm).
- All components are non handed.
- The use of ball bearing hinges is recommended for the door on which the closer will be installed. Door must swing freely.
- Where severe or abusive conditions are expected a separate door stop, supplied by others, is recommended to assist in preventing damage to the door closer, closer arm; or to the door, frame or adjacent walls.
- Door and frame must be properly reinforced, or the use of special fasteners employed, to prevent door collapse or the mounting screws from pulling out.
- All dimensions are given in inches with corresponding metric dimensions (millimeters) in parentheses.

Template

Pull Side Installation

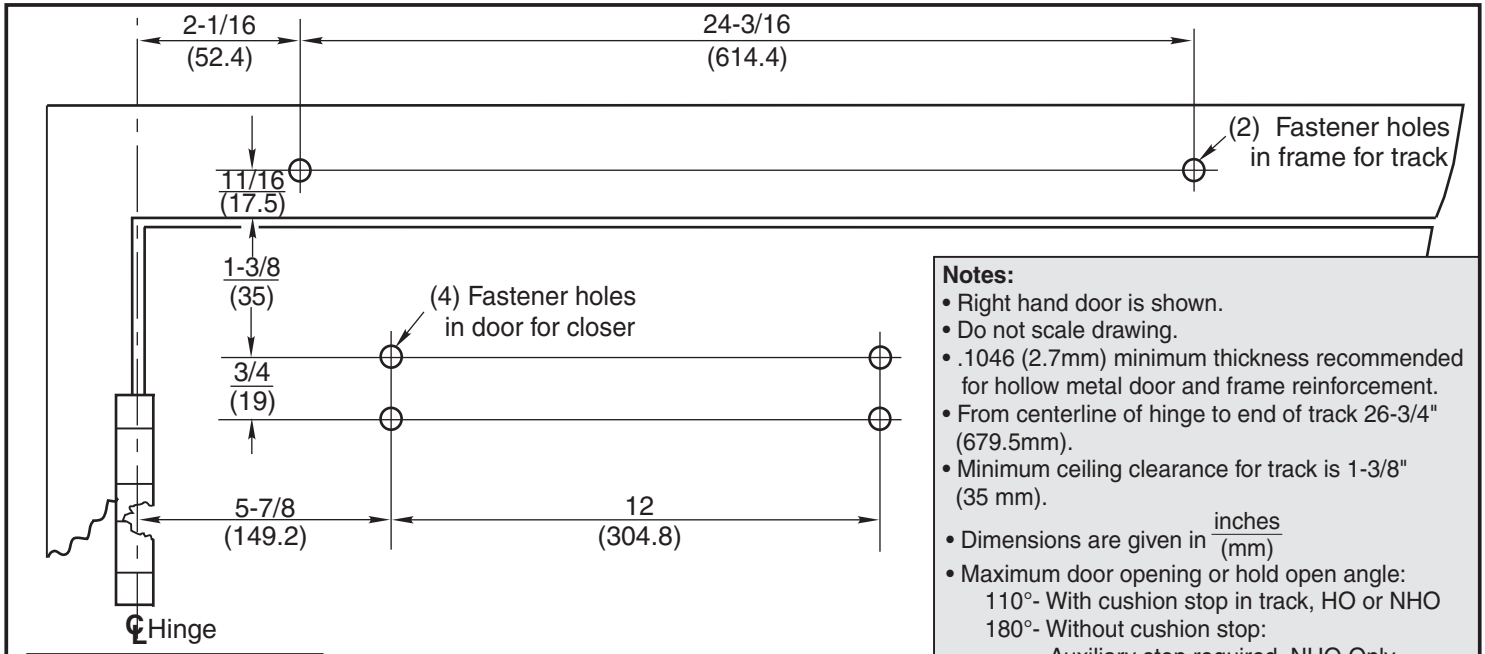

- Notes:**
- Right hand door is shown.
 - Do not scale drawing.
 - .1046 (2.7mm) minimum thickness recommended for hollow metal door and frame reinforcement.
 - From centerline of hinge to end of track 26-3/4" (679.5mm).
 - Minimum ceiling clearance for track is 1-3/8" (35 mm).
 - Dimensions are given in $\frac{\text{inches}}{\text{(mm)}}$
 - Maximum door opening or hold open angle:
 - 110° - With cushion stop in track, HO or NHO
 - 180° - Without cushion stop: Auxiliary stop required, NHO Only
 - Use of auxiliary door stop may be required to prevent damage to door, frame, or hinges.

Pull Side

• Sex bolts not shown

1/4-20 x 5/8 lg. phillips drive with thread lock & arm washer

Screw pack

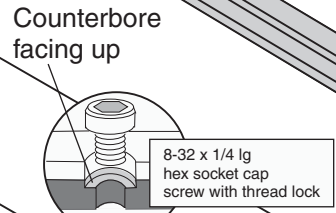
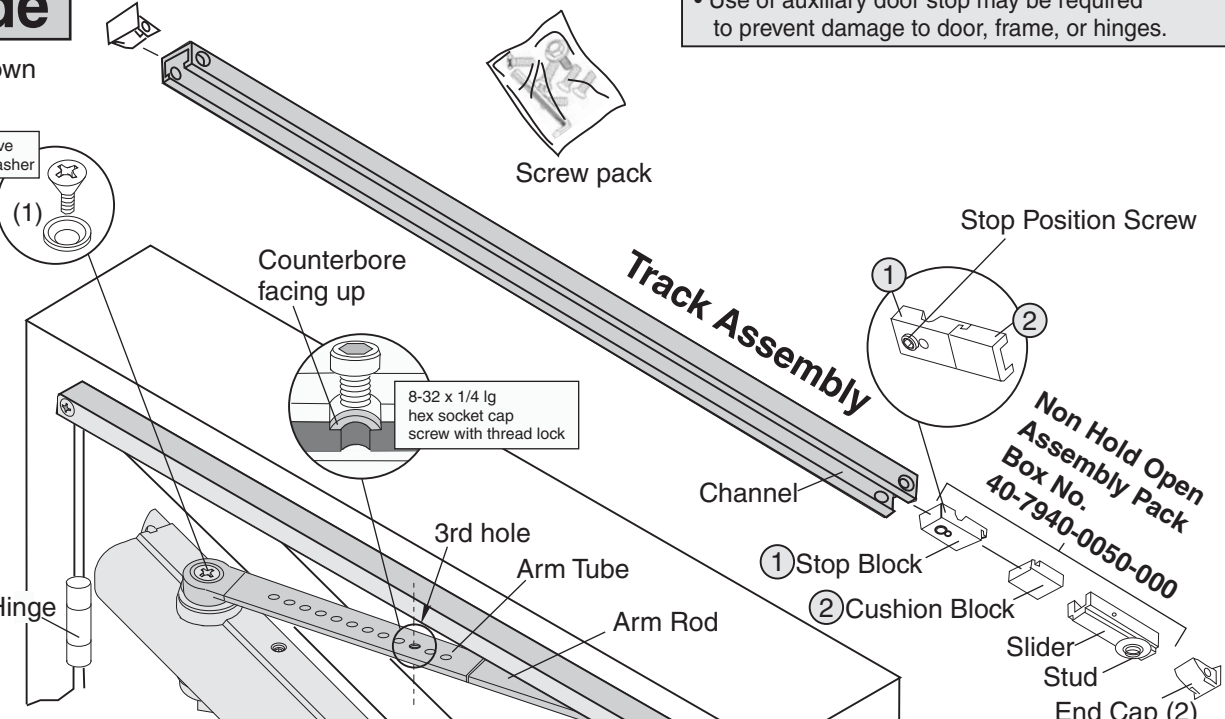

Stop Position Screw

Non Hold Open Assembly Pack
Box No. 40-7940-0050-000

Slider Stud
End Cap (2)

3500 Series Cover

Full Plastic Cover with Insert

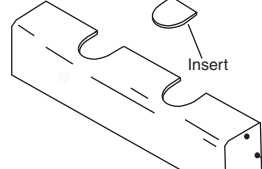

Optional 3500M Series Cover

Full Metal Cover with Cover Screws and Cover Clips

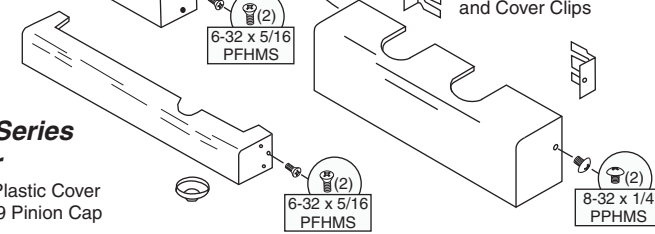

3300 Series Cover

Narrow Plastic Cover with 1639 Pinion Cap

1/4-20 x 5/8 lg. truss head phillips drive with thread lock

Hold Open Assembly Pack
Box No. 40-7940-0051-000

Spring
Slider Stud
End Cap (2)

Installation Sequence

Pull or Push Side Mount

- **Determine hand of door and type of installation** from illustrations on Page 1.
- **Use template dimensions** on Page 2 or Page 4 to locate fastener holes on door and frame. See "Preparation for Fasteners" chart.
 - Frame:** Prepare the frame for mounting track. Drill and tap holes for 1/4-20 machine screws or #14 wood screws.
 - Door:** Prepare the door for mounting closer. Drill and tap (4) holes for 1/4-20 machine screws, #14 wood screws, 3/8 diameter sex-nuts, or through bolts and grommet-nuts.
 - Note:** If drop plate is used (see Page 4), prepare holes for 3148/3548/3158 drop plate instead of closer. Secure drop plate before mounting closer.
- **Fasten closer to door or drop plate.** Position closer with:
 - Pull side-** power adjustment shaft **away** from hinge
 - Push side-** power adjustment shaft **toward** hinge
 Secure mounting screws.
 - Note:** If using full metal cover, mounting clips must be slipped under ends of closer when closer is being mounted. Clips should project 1/4" (6 mm) from each end of closer.
- **Assemble Slide Arm.** Insert flat arm rod into arm tube with the counterbore screw hole facing up. Align counterbore with the 3rd hole in the arm tube and secure with 8-32 x 1/4 long hex socket cap screw. See illustration on Page 2 or 4.
- **Install arm on closer pinion-**see arm indexing illustrations below.

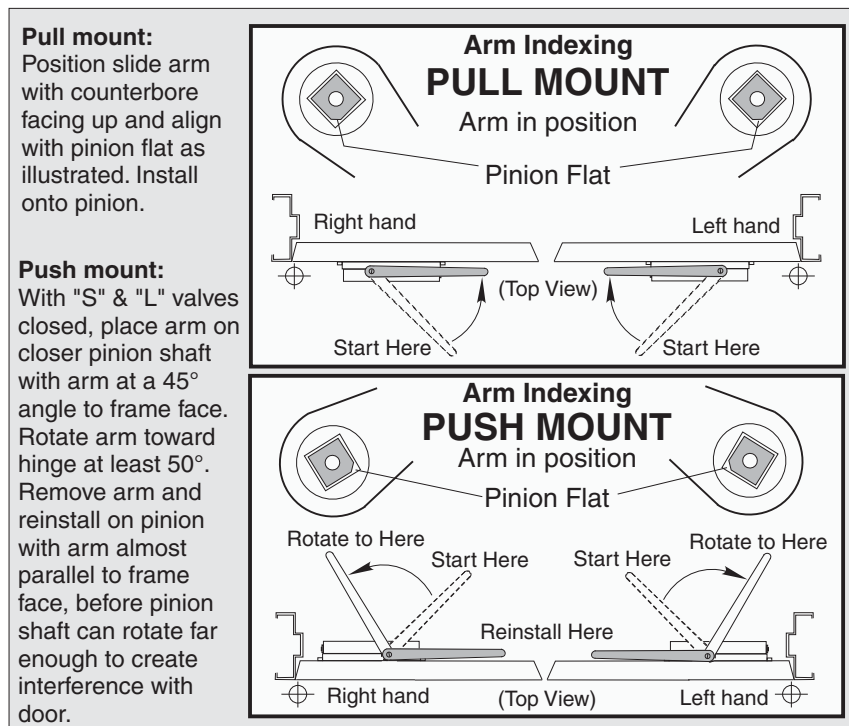

- **Secure arm** with washer and flat head phillips drive arm screw with thread lock.

Preparation for Fasteners		
Fasteners	Door or Frame	Drill Sizes
#14 type "A" S.M. screw Closer: 1-1/4" (32mm) Track: 2-3/4" (70mm)	Wood	7/32" (5.56mm)
1/4" -20 machine screw	Metal	drill: #7 (.201") tap: 1/4" -20
Sex-nuts and bolts	Hollow Metal	9/32" (7.00mm) through 3/8" (9.50mm) door-face opposite to closer
	Aluminum or Wood	3/8" (9.50mm) through
Through-bolts and grommet-nuts (Optional)	All	9/32" (7.00mm) through; 3/8" (9.50mm) dia. x 3/8" (10mm) deep door-face opposite to closer

- **Track Assembly**
Remove slider assembly parts from box # 40-7940-0050-000 for Non Hold Open or # 40-7940-0051-000 for Hold Open and insert into channel in the order shown. See illustration on Page 2 or 4.
 - Use of the hold open assembly pack on a non hold open device will void the UL® listing for this product.**
 Insert end caps into ends of track prior to installing.

- **Install track to frame.** Place the assembled slide track against frame with the open side down, stop and cushion blocks toward the hinge. Move the slider to the opposite end of the slide track. Secure slide track with 1/4-20 flat head phillips drive mounting screws.

- **Connect arm to track.**
 - Pull side:** With door closed.
 - Push side:** With door open slightly. Rotate arm to slider and place end over stud. Push up on arm and tap gently to seat (to prevent stud from turning during assembly). Secure with 1/4-20 x 5/8" long truss (rounded) head phillips drive screw with thread lock. CAUTION: Closer arm is under spring tension and may be difficult to rotate.

- **Set door stop angle.** Open door to the angle you want the door to stop. With the door held at that location, slide stop with cushion block against slider. Tighten the stop position screw (large set screw) with 3/16" hex wrench (from screw pack) until secure. Release door.

- **Adjust closer** (see Page 5) before installing cover.

- **Install Cover.**
 - Full Cover:** Slide insert into unused cover slot (see illustration on Page 2 or 4). Install cover using screws provided.
 - Narrow Cover:** Install cover using screws provided. Thread pinion cap into pinion shaft. Do not overtighten.
 - Full Metal Cover:** Fasten cover to mounting clips with screws provided.

Template

Push Side Installation

Viewed from Top

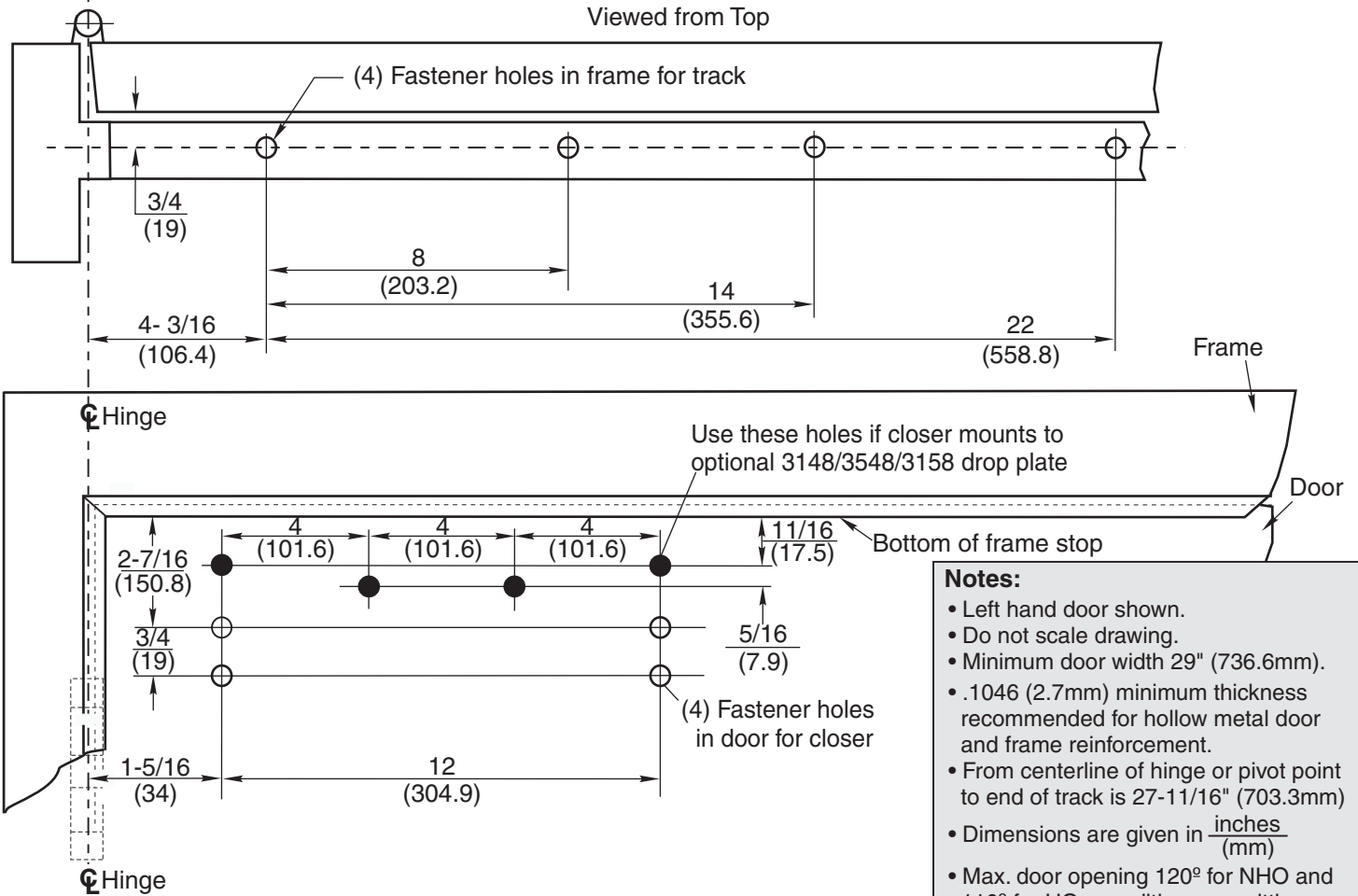

Notes:

- Left hand door shown.
- Do not scale drawing.
- Minimum door width 29" (736.6mm).
- .1046 (2.7mm) minimum thickness recommended for hollow metal door and frame reinforcement.
- From centerline of hinge or pivot point to end of track is 27-11/16" (703.3mm)
- Dimensions are given in $\frac{\text{inches}}{\text{(mm)}}$
- Max. door opening 120° for NHO and 110° for HO., conditions permitting.
- Use of auxiliary door stop may be required to prevent damage to door, frame, or hinges.

Push Side

- Drop Plate and sex bolts not shown

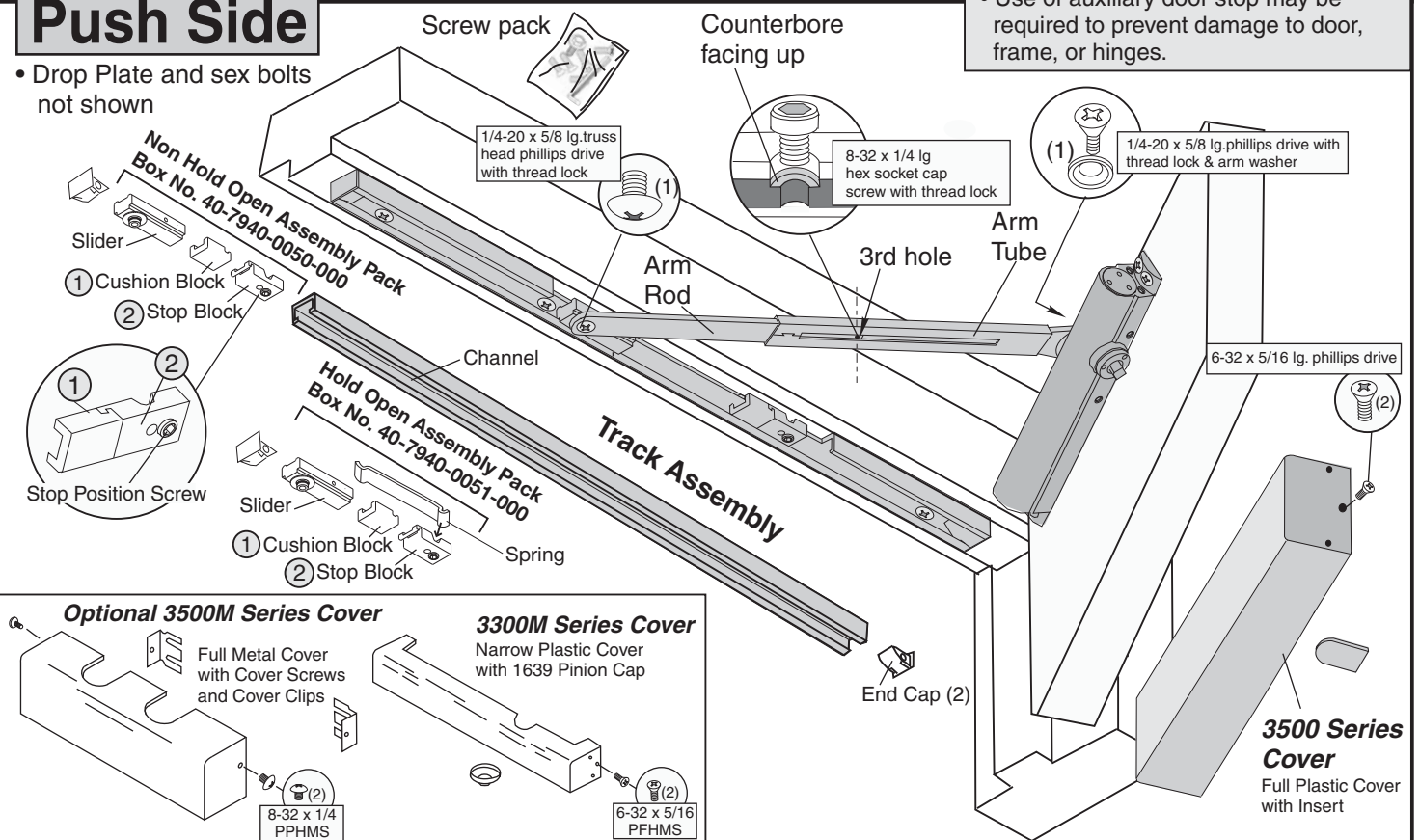

Closer Adjustments

Closing Power

3340/3540 & 3350/3550 Models come in three different sizes (4 through 6); each power size can be increased by 50%. Adjust as required. **See Figure 1.**

3341/3541 & 3351/3551 Models are adjustable sizes 1 thru 6.

For proper sizing see power adjustment chart below right.

To adjust closer power, **see Figure 1.**

Increase or decrease power as necessary.

Closing Cycle (see illustrations below).

Valve "L" controls door speed in **Latch Range**.

Valve "S" controls door speed in **Sweep Range**.

Valve "D" (Optional) controls door speed in **Delay Range**.

Use 1/8" hex-key furnished and adjust as shown in **Figure 2.**

Attention: Adjust closing speed to between 4 to 7 seconds from 90°. Use of door by handicapped, elderly or small children may require greater closing time.

Opening Cycle (see illustration below).

Valve "B" cushions (slows) door opening in the **Backcheck Range**.

NOTE: Never close this valve completely or damage to closer may occur.

Closing Power Control Figure 1

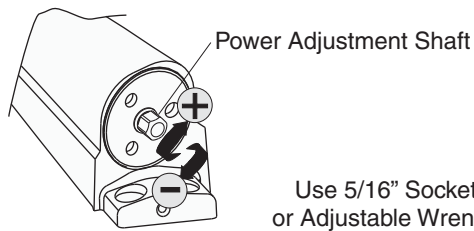

Opening Controls

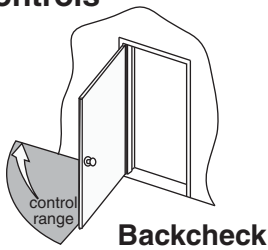

Closing Speed Controls

Figure 2

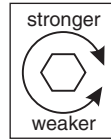

"B" (Backcheck)
NEVER close completely

Optional
"D" (Delay Range)

"L" (Latch)

All valves are adjusted with 1/8" hex-key, furnished.

Caution:
Do not back valves out of closer or a leak will result.

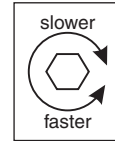

"S" (Sweep)

Power Adjustment Chart

Door Size Inches (meters)	Full Clockwise Turns of Closer Power Adjustment Shaft	
	Interior Door	Exterior Door
28-32 (0.07-0.80)	10	13
33-36 (0.85-0.90)	12	15
37-42 (0.95-11.05)	14	17
43-48 (1.10-1.20)	17	19

Note:
Power adjustments charted are recommended where possible to insure proper door control. See Note on Page 1 where codes may dictate reducing these recommended adjustments.

NOTE: Maximum of 20 turns (360°) of Power Adjustment Shaft.

- Set closing power, as charted. Closer is shipped at power setting as circled. See Figure 1 at left for illustration of how to make these adjustments.

Closing Controls

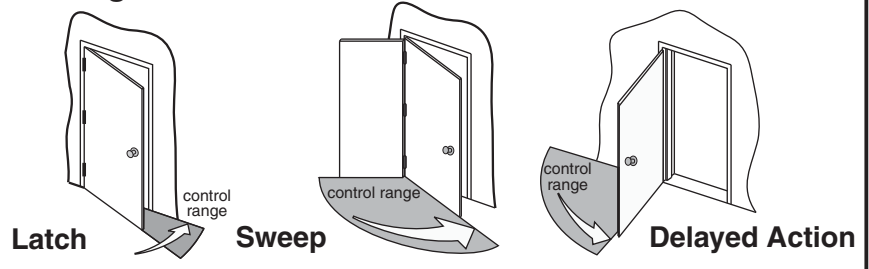

Yale

An ASSA ABLOY Group brand

3000 Highway 74 East • Monroe, NC 28112
Tel: (800)-438-1951 • Fax: (800)-338-0965
www.yalecommercial.com