



4700LN Series

ANSI/BHMA Grade 1 Certified Cylindrical Lever Locks



ACCENTRA

ASSA ABLOY

ASSA ABLOY is transitioning the Yale Commercial brand to ACCENTRA. This affects only the brand name; the products and product numbers will remain unchanged. Prior to May 20, 2024, products may be shipped either as Yale Commercial brand or ACCENTRA brand. Products shipping after May 20, 2024, will be branded ACCENTRA.



Contents

Features	3
Finishes & How To Order	4
Lever Trim	5
Functions	6-8
Electrified Options	9
Electrified Accessories	10
Cylinders	11
Cylinders/Keying	12
Latchbolts	13
Strikes	14

4700LN Series Cylindrical Lever Locks

Yale® 4700LN cylindrical locks are the ideal choice for a wide variety of commercial applications where consistent quality, ease of use and installation are required at an economical price. The 4700LN Series is certified to ANSI/BHMA Grade 1 standards and is UL fire-listed for all functions ensuring reliability and peace of mind.



Features

Features

- Available in 19 functions, 5 lever designs, and 9 finishes
- Knurled lever designs available
- Freewheeling trim
- Available with Microshield® antimicrobial coating



Specifications

Door Thickness	1-3/4" (44mm) to 2" (51mm); 1-3/8" (35mm) or 2-1/4" (57mm), please specify on order
Strike	ANSI 4-7/8" x 1-1/4" x 1-1/4" (124mm x 32mm x 32mm) lip to center. See page 14 for optional strikes.
Backset	2-3/4" (70mm)
Handing	Non-handed
Installation	ANSI/BHMA A156.115(-W)
ANSI/BHMA	Certified ANSI/BHMA A156.2, Series 4000 Grade 1
Warranty	5 year

Applications and Listings

- UL – cUL listed for use on fire doors having a rating up to and including 3 hours
- Windstorm certified refer to local codes
- Meets accessibility guidelines for the Americans with Disabilities Act and the requirements of the Uniform Federal Accessibility Standards and ANSI 117.1

Note: Any retrofit or other field modification to a fire-rated opening can potentially impact the fire-rating of the opening, and Yale Locks & Hardware makes no representations or warranties concerning what such impact may be in any specific situation. When retrofitting any portion of an existing fire rated opening, or specifying and installing a new fire-rated opening, please consult with a code specialist or local code official (Authority Having Jurisdiction) to ensure compliance with all applicable codes and ratings.



Finishes



ANSI/BHMA Code Finish Description				
605 Bright Brass, Clear Coated	606¹ Satin Brass, Clear Coated	612 Satin Bronze, Clear Coated	613E Dark Oxidized Satin Bronze - equivalent	619* Satin Nickel Plated, Clear Coated
625 Bright Chrome Plated	626*¹ Satin Chrome Plated	BSP¹ Black Suede Powder Coat	WSP White Suede Powder Coat	

1. Cylinders provided in these finishes only.

Note: Dark Oxidized Satin Bronze, Oil Rubbed (613) and Black Oxidized Bronze, Oil Rubbed (722) finishes are available by Special Product Application Request only. Contact customer service for more information.

*Finish available with MicroShield® antimicrobial coating, additional finishes by special application. Consult factory for availability.

MicroShield coating may vary finish color from architectural standards. MicroShield is not intended as a substitute for traditional infection control programs such as hand hygiene or use of disinfectants. Coated products must still be cleaned to ensure the surfaces will be free of destructive microbes. Yale makes no representations or warranties, express or implied, as to the efficacy of MicroShield.

How To Order

Trim Design	Function	Hand	Latch	Strike	Cylinder	Door Thickness	Finish
See page 8	See pages 5-7	See page 3	See page 13	See page 14	See pages 11-12	See page 3	See page 4

Ordering Example

Trim Design	Function	Hand	Latch	Strike	Cylinder	Door Thickness	Finish
AU	4707LN	RH	694	497	1803-47L	1-3/4"	626



Lever Trim

Augusta AU

Lever: Cast Zinc
Rose: Wrought Brass

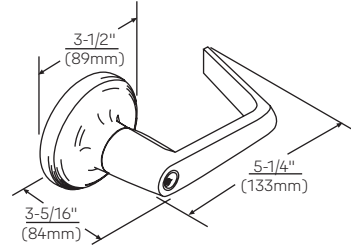
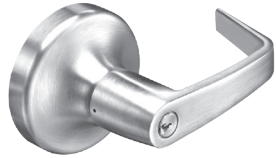

Monroe MO

Lever: Cast Zinc
Rose: Wrought Brass

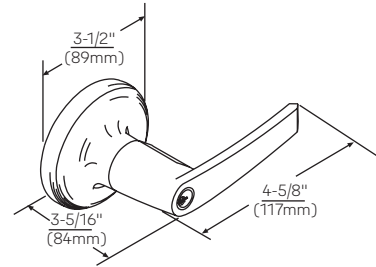

Pacific Beach PB

Lever: Cast Zinc
Rose: Wrought Brass

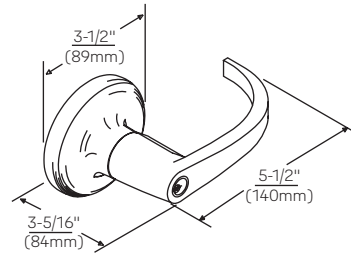

TB

Lever: Cast Zinc
Rose: Wrought Brass

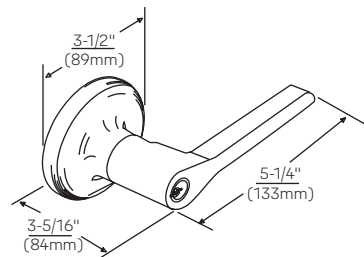

UB

Lever: Cast Zinc
Rose: Wrought Brass

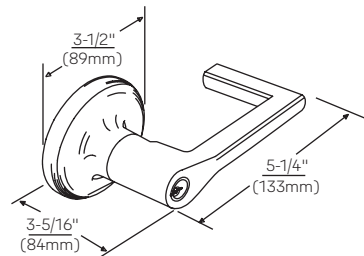

Available with large and small format interchangeable core. See page 11-12 for details.

Dimensions shown are in inches (mm).

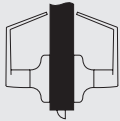
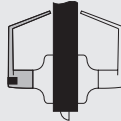
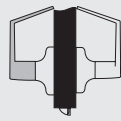
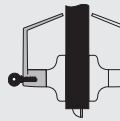
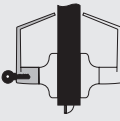
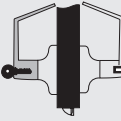
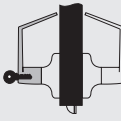
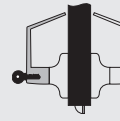

4701LN (F75)	4702LN (F76A)	4703LN (F77A)	4704LN (F82A)
<p>Passage or Closet Latch</p> <ul style="list-style-type: none"> For doors that do not require locking. Either lever operates latchbolt at all times.  <p>Outside Inside</p>	<p>Privacy, Bedroom or Bath Lock</p> <ul style="list-style-type: none"> For lavatory or other privacy doors. Either lever operates latchbolt unless outside lever is locked by pushbutton inside.* Button automatically releases when inside lever is turned or door is closed. Emergency key inserted and turned in hole in outside lever will unlock door from outside. (Emergency key furnished with lockset. P/N 14-5302-1053-048) Inside lever always active.  <p>Outside Inside</p>	<p>Patio or Privacy Lock</p> <ul style="list-style-type: none"> For exit doors with limited entry. Deadlocking latchbolt. Either lever operates latchbolt unless outside lever is locked by pushbutton inside.* Button automatically releases when inside lever is turned or door is closed. Inside lever always active.  <p>Outside Inside</p>	<p>Entry Lock</p> <ul style="list-style-type: none"> For entrance or office doors. Deadlocking latchbolt. Either lever operates latchbolt (except when outside lever is locked from inside).* Pushing button in inside lever locks outside lever. (Automatically releases when inside lever is turned or key is rotated in locked outside lever.) Latchbolt is operated by key in outside lever or by rotating inside lever. Inside lever always active.  <p>Outside Inside</p>
4705LN (F86)	4706LN (F92)	4707LN (F109)	4708LN (F84)
<p>Storeroom or Closet Lock</p> <ul style="list-style-type: none"> For use on storeroom, utility, exit doors. Deadlocking latchbolt. Latchbolt operated by lever inside, key in outside lever. Outside lever always locked.* Inside lever always active.  <p>Outside Inside</p>	<p>Service Station Lock</p> <ul style="list-style-type: none"> Deadlocking latchbolt. Either lever operates latchbolt. Pushbutton in inside lever locks outside lever. (Automatically releases when inside lever is turned, door is closed or key is rotated in outside lever, except when slotted pushbutton is rotated 90° clockwise to retain outside lever in locked position.)* Latchbolt operated by key in outside lever, inside lever always active.  <p>Outside Inside</p>	<p>Entry Lock</p> <ul style="list-style-type: none"> For entrance, general home or office doors. Deadlocking latchbolt. Either lever operates latchbolt (except when outside lever is locked from inside).* Pushing turn button in inside lever locks outside lever. (Automatically releases when inside lever is turned or key is rotated in locked outside lever.) Outside lever may be retained in locked position by pushing and rotating turn button 90° clockwise to a horizontal position; not released until turn button is manually returned to the vertical position. Latchbolt is operated by key in outside lever or by rotating inside lever. Inside lever always active.  <p>Outside Inside</p>	<p>Classroom Lock</p> <ul style="list-style-type: none"> For classroom or utility room doors. Deadlocking latchbolt. Either lever operates latchbolt (except when outside lever is locked by key).* Inside lever always active. Key releases outside lever.  <p>Outside Inside</p>

* Lever handles are Free-Wheeling in locked position. Shaded area denotes FreeWheeling lever.

Functions

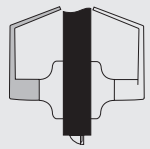
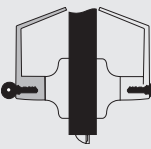
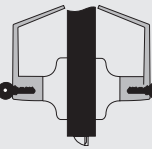
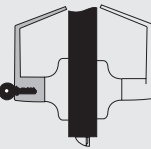
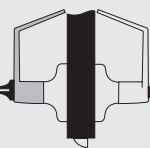
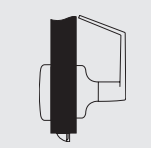
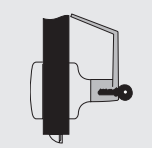
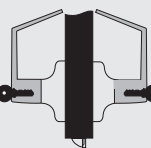

4709LN (F89)	4718LN (F110)	4721LN (F80)	4722LN (F90)
<p>Exit Latch</p> <ul style="list-style-type: none"> For exit doors with no-entry desired. Deadlocking latchbolt. Outside lever always locked.* Inside lever always active.  <p>Outside Inside</p>	<p>Intruder Classroom Lock</p> <ul style="list-style-type: none"> For classroom doors. Deadlocking latchbolt. Either lever operates latchbolt (except when outside lever is locked by key from either side). Outside lever remains locked upon egress Inside lever always active. <p>(NOTE: Not available with I.C. core cylinders.)</p>  <p>Outside Inside</p>	<p>Communicating Lock</p> <ul style="list-style-type: none"> For communicating or store entrance doors. Deadlocking latchbolt. Either lever operates latchbolt (except when key in either lever locks or unlocks the lever independently of the other).* Should be used only in offices or rooms with multiple entries. <p>(NOTE: Not available with I.C. core cylinders.)</p>  <p>Outside Inside</p>	<p>Corridor Lock</p> <ul style="list-style-type: none"> Deadlocking latchbolt. Either lever operates latchbolt (except when outside lever is locked by inside push-button or key in outside lever). Inside lever always active. When locked by button, the button automatically releases when inside lever is turned or door is closed. When locked by key, the automatic release is made inoperative and must be manually unlocked by key.  <p>Outside Inside</p>
4725LN	4728LN (F111)	4729LN (F113)	4730LN
<p>Privacy Lock</p> <ul style="list-style-type: none"> For lavatory or other privacy doors. Either lever operates latchbolt (except when outside lever is locked by inside pushbutton).* Button automatically releases by turning inside lever or closing door. Door can be unlocked, when necessary, by operating outside turnbutton. No emergency key required. Optional flush turnbutton available for outside. Specify option "FTB".  <p>Outside Inside</p>	<p>Communicating Passage Lock</p> <ul style="list-style-type: none"> For twin communicating or exit doors where one side operation is required. Also when space is limited between door and switch panel. Deadlocking latchbolt. One lever operation. Blank rose. Should be used only where rooms have more than one entrance.  <p>Outside Inside</p>	<p>Communicating Classroom Lock</p> <ul style="list-style-type: none"> For twin communicating or closet doors where one side operation is required or space between doors is limited. Deadlocking latchbolt. Inside lever operates latchbolt except when lever is locked by key.* Blank rose. Should be used only where rooms have more than one entrance. <p>(NOTE: Not available with I.C. core cylinders)</p>  <p>Outside Inside</p>	<p>Utility, Asylum or Institutional Lock</p> <ul style="list-style-type: none"> Deadlocking latchbolt. Latchbolt operated by key in lever from either side. Both levers always locked.* <p>Note: Not available with IC core cylinders.</p>  <p>Outside Inside</p>

* Lever handles are Free-Wheeling in locked position. Shaded area denotes FreeWheeling lever.

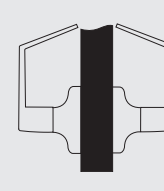

4739LN (F112)	4755LN	4755LN-D
<p>Communicating Storeroom Lock</p> <ul style="list-style-type: none"> • For twin communicating or closet doors where one side operation is required or space between doors is limited. • Deadlocking latchbolt. • Latchbolt operated by key only in inside lever. • Inside lever always locked.* • Blank rose. • Should be used only where rooms have more than one entrance. <p>(Note: Not available with I.C. core cylinders)</p>  <p>Outside Inside</p>	<p>Single Dummy Trim</p> <ul style="list-style-type: none"> • For non-operational levers used for decorative trim. • Rigid lever.  <p>Outside Inside</p>	<p>Double Dummy Trim</p> <ul style="list-style-type: none"> • For non-operational lever used for decorative trim. • Through-bolted.  <p>Outside Inside</p>

* Lever handles are Free-Wheeling in locked position. Shaded area denotes FreeWheeling lever.



Electrified Options

Operation

Electric locks provide the ability to electrically lock or unlock the outside trim from a remote location. Fail Safe locks are commonly used in stair towers to release upon fire alarm activation. Fail Secure locks are used on perimeter doors or security doors to allow ingress using access control technologies (proximity cards, keypads, etc.)



Features

- Free Wheeling lever mechanism.
- Self-contained, continuous-duty integral solenoid (allows installation in standard cylindrical prep).
- Available Fail Safe or Fail Secure.
- Available in 12 or 24 volts DC.
- External rectifier available upon request for AC operation.
- Mechanical cylinder override.
- All 4700LN cylinder options.
- Certified ANSI/BHMA Grade 1. 
- UL listed.
- 1-year limited warranty.

Electrical Specifications

- Continuous duty solenoid
150 mA @ 24VDC
300 mA @ 12VDC

ElectroLynx®

Yale® electrified 4700LN locks are equipped with ElectroLynx connectors. As a standard feature, these connectors link power from the incoming source to electrified locking products, including hinges, locks, exit devices, magnetic holders and strikes.

Note: Electrified door hardware with ElectroLynx connectors requires a compatible number of lead wires attached to the door hinge.

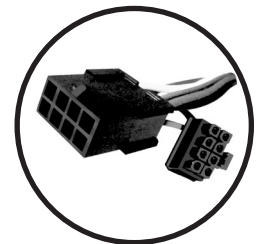

Functions

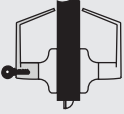
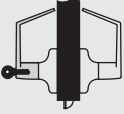
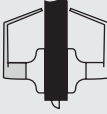
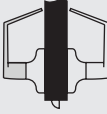
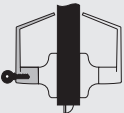
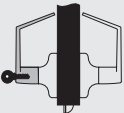
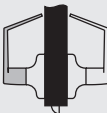
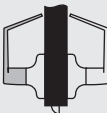
Outside	Inside	Function	Function Description	Outside	Inside	Function	Function Description
		4790LN	Fail Safe <ul style="list-style-type: none"> • Deadlocking latchbolt by lever either side except when power on locks outside lever. • Power off/unlocks outside lever. • Inside lever always free. • Latchbolt retracted by key when power is on. 			4780LN	Fail Safe <ul style="list-style-type: none"> • Deadlocking latchbolt by lever either side except when power on locks outside lever. • Power off/unlocks outside lever. • Inside lever always free.
		4791LN	Fail Secure <ul style="list-style-type: none"> • Deadlocking latchbolt by lever either side except when power off locks outside lever. • Power on/unlocks outside lever. • Inside lever always free. • Latchbolt retracted by key when power is off. 			4781LN	Fail Secure <ul style="list-style-type: none"> • Deadlocking latchbolt by lever either side except when power off locks outside lever. • Power on/unlocks outside lever. • Inside lever always free.

Electrified Options



BPS Power Supplies By Securitron®

Operation

Power supplies are designed to provide reliable filtered and regulated power for long life to a variety of electrified hardware components.

Product Features

- Individual output circuit breakers
- Regulated and filtered fuse protected outputs
- LEDs monitor zone status (voltage or no voltage)
- Slide switches connect or disconnect load from power (Not available on 1 Amp supplies)
- Internal Back-Up battery charging circuit
- Rugged steel enclosure
- Fire alarm interface

Listings

- UL CLASS 2

Applications (use with):

- Fail Safe cylindrical locks
- Fail Secure cylindrical locks

Ordering

Ex: BPS-24-4, BPS-12-3

Model	Input	Output	Application
BPS-24-1	120 VAC	1 Amp @ 24 VDC	2-4700LN
BPS-24-2	120 VAC	2 Amp @ 24 VDC	5-4700LN
BPS-24-4	120 VAC	4 Amp @ 24 VDC	11-4700LN
BPS-12-1	120 VAC	1 Amp @ 12 VDC	1-4700LN
BPS-12-3	120 VAC	2 Amp @ 12 VDC	3-4700LN

Consult factory for additional power supply applications.

Yale recommends McKinney®, Pemko and Securitron® for power transfer devices and other electronic accessories.

Cylinders



Cylinder Options

The following selection guide indicates the correct cylinder for each locking segment.

Lockset Series:	Types of Cylinder Mechanisms						
	Conventional		Protected Keyway		Security		
4700LN							
Cylinder Types	Fixed Core	6-pin	7-pin	6-pin	7-pin	6-pin	7-pin
Key-In-Lever	1803-47L*	N/A	K403-47L*	N/A	5803-47L*	N/A	
	Interchangeable Core						
LFIC	1210	N/A	K800	N/A	5210	N/A	
SFIC	A600	A600	K600	K600	N/A	N/A	

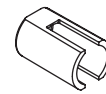
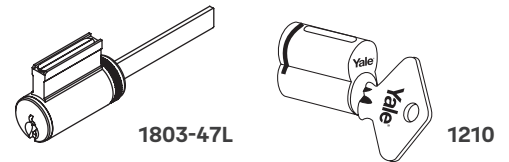

Cylinder Sleeve*
P/N 14-1803-9001-999

Refer to Yale® KeyMark® and/or Cylinders and Keys Catalog sections for all details and how-to-order examples.

*Cylinders require cylinder sleeve P/N 14-1803-9001-999 to fit locksets manufactured prior to January 2022.

Yale® KeyMark®

For those applications requiring protected key control, Yale® KeyMark® cylinders guard against unauthorized key duplication.

The Yale KeyMark Security Leg® keyway feature increases resistance against picking and impressioning and can easily retrofit into existing systems. For further details and availability, refer to the separate Yale KeyMark catalog.

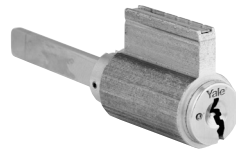

Security Cylinders

Security cylinders contain two independent locking mechanisms. The first is a traditional 6-pin tumbler mechanism with spool drivers for greatly increased picking resistance.

The second is an innovative 5-tumbler rotating disc mechanism with sidebar engagement. The rotating discs are spring loaded and block the bottom of the keyway.

Illustration

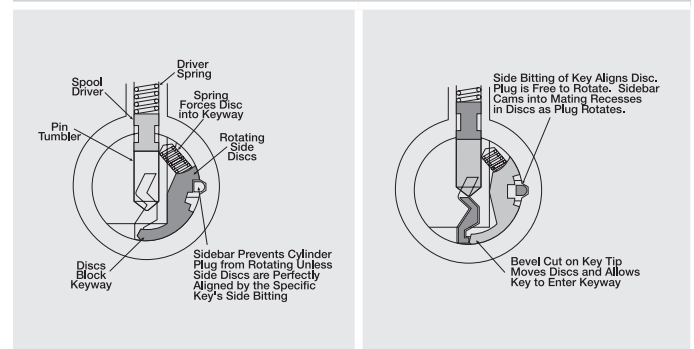

108S Schlage® Cylinder Adapter Kit

Kit used to modify Schlage® cylinder for fit in the 4700LN.

P/N 14-5305-0090-048 - 108S

Kit includes tailpiece and sleeve. To order the 108S adapter kit, use an "S" prefix (i.e., S-AU4707LN).

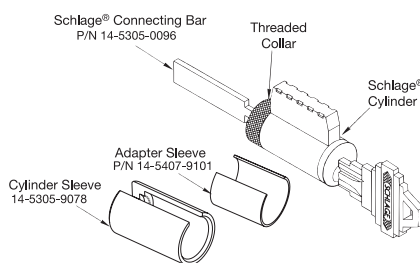



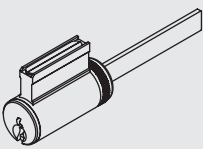

Other Manufacturer Keyway Cylinder/Cores

Illustration	Description	Lever	Number of Pins
	Best® Keyway Core. Available keyed random, master keyed or uncombined. Specify keyway A, B, C, D, E, F, G, H, J, K, L or M.	A600	6 or 7 (Specify)
 Lever Cylinder	Schlage® C Keyway Cylinder. Available 0-bitted or keyed random.	2803-47L x C	6
	Corbin Russwin L4 Keyway Cylinder. Available keyed random.	3803-47L x L4	6
	Corbin 60 Keyway Cylinder. Available keyed random.	3803-47L x 60	6
	Russwin D1 Keyway Cylinder. Available keyed random.	3803-47L x D1	6
	Sargent® LA Keyway Cylinder. Available keyed random.	3803-47L x LA	6
	Schlage® E Keyway Cylinder. Available keyed random.	3803-47L x E	6

Notes: The 2803 and 3803 cylinders require a cylinder sleeve (P/N 14-1803-9001-999) to fit 4700LN locksets manufactured prior to January 2022.

Levers Accepting SFIC And Other Manufacturers' Large Format Interchangeable Cores

Illustration	Description	Prefix	Number of Pins
	SFIC (Accepts all Small Format Interchangeable Cores)	B (i.e. B-AU, B-MO, B-PB, B-TB, B-UB)	6 or 7
	Medeco®, ASSA® (LFIC)	M* (i.e. M-AU)	6
	Schlage® (LFIC)	SI (i.e. SI-AU, SI-PB)	6

*Medeco®, ASSA® option available only with AU lever. (Note: For Medeco 32 series cores.)

LFIC = Large Format Interchangeable Core

SFIC = Small Format Interchangeable Core

Levers Accepting Other Manufacturers' Fixed Core Cylinders

Illustration	Description	Prefix	Number of Pins
	Schlage®	S (i.e. S-AU, S-MO, S-PB)	6



Latchbolts

Plain Latchbolts

Model No. 693 supplied standard with all 4700LN series locksets without locking function. Standard plain latchbolt has a 2-1/4" (57mm) x 1-1/8" (29mm) beveled front with a 2-3/4" (70mm) backset and a 1/2" (13mm) bolt throw. Optional latchbolts with a greater backset/throw available to special order.

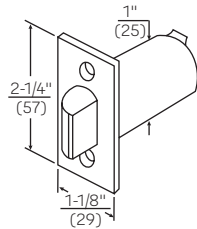

Model No.	Front	Backset	Throw	Front Width	Latch Diameter
693	Beveled	2-3/4" (70mm)	1/2" (13mm)	1-1/8" (29mm)	1" (25mm)
F693	Flat	2-3/4" (70mm)	1/2" (13mm)	1-1/8" (29mm)	1" (25mm)
3693	Beveled	3-3/4" (95mm)	1/2" (13mm)	1-1/8" (29mm)	1" (25mm)

Note: for 3/4" throw applications, only deadlocking latchbolts available.

Deadlocking Latchbolts

Deadlocking latchbolt Model No. 694 supplied standard with all 4700(LN) series locksets with locking function. Standard deadlocking latchbolt has a 2-1/4" (57mm) x 1-1/8" (29mm) beveled front with a 2-3/4" (70mm) backset and a 1/2" (13mm) bolt throw. Optional latchbolts with a greater backset/throw available to special order.

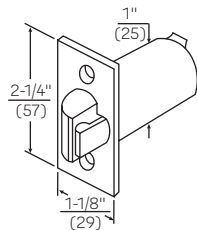

Model No.	Front	Backset	Throw	Front Width	Latch Diameter
694	Beveled	2-3/4" (70mm)	1/2" (13mm)	1-1/8" (29mm)	1" (25mm)
F694	Flat	2-3/4" (70mm)	1/2" (13mm)	1-1/8" (29mm)	1" (25mm)
3694	Beveled	3-3/4" (95mm)	1/2" (13mm)	1-1/8" (29mm)	1" (25mm)
480B	Beveled	2-3/4" (70mm)	3/4" (19mm)	1-1/8" (29mm)	1" (25mm)
F480B	Flat	2-3/4" (70mm)	3/4" (19mm)	1-1/8" (29mm)	1" (25mm)
3480B	Beveled	3-3/4" (95mm)	3/4" (19mm)	1-1/8" (29mm)	1" (25mm)

Note: for 2-3/8" backset, contact Customer Support.

Backset Extension Links

All 4700LN Series locksets are supplied with standard latchbolts of 2-3/4" (70mm) backset; optional latchbolts with a 3-3/4" (95mm) backset are available to special order for lever locksets only. Extension links are also available for attachment to 2-3/4" (70mm) or 3-3/4" (95mm) backset latchbolts to extend the backset to the desired length.

Desired Backset	Latchbolt Backset	Order Extension List No.
5" (127mm)	2-3/4" (70mm)	481DL
6" (152mm)	3-3/4" (95mm)	481
7" (178mm)	2-3/4" (70mm)	482
8" (203mm)	3-3/4" (95mm)	482
18" (46cm)	2-3/4" (70mm)	484
19" (48cm)	3-3/4" (95mm)	484

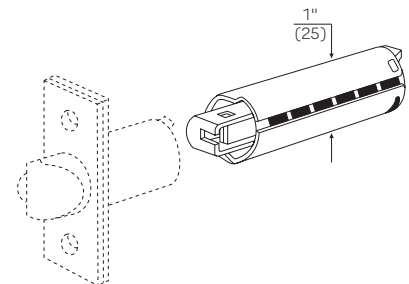

Other extension links up to 42" (1.06m) backset are available to special order.

Attaching Screws

(Not regularly supplied when latchbolts ordered separately).

- For all latchbolts**

- #8-8-32 x 3/4" (19mm) Phillips flat head combination wood and machine screws
- Brass - P/N 81-2022-0416*
- Bronze - P/N 81-2032-0416*

*Specify finish required.

- Hollow Metal Doors**

- #8 - 32 x 1" (25mm) Phillips flat head machine screw
- Brass - P/N 81-0022-0420*
- Bronze - P/N 81-0032-0420*

Strikes



Yale® 4700LN locks are available with a variety of strike options. All strikes are located on the same vertical and horizontal center lines as the latchbolt. Some strikes are available in a variety of lip lengths to accommodate varying thickness of doors and frames. To determine the proper length of the lip, measure from the center line of the strike to the edge of the jamb, accounting for any interfering trim (i.e. wood molding) and then add 1/4" (6mm) for curved lip. All strikes are reversible. Strikes are fabricated of either brass, bronze or stainless steel, depending on the lockset trim finish. When ordering strikes separately, specify the finish required.

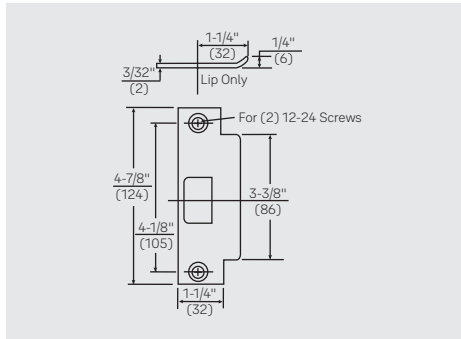

Model No. 497 ANSI Strike (Standard)

For door and frames with ANSI/BHMA A156.115 preparations. 4-7/8" x 1-1/4" x 1-1/4" (124mm x 32mm x 32mm) lip to center supplied standard. 1-1/8", 1-1/2", and 1-3/4" lip lengths available by special order. Available with optional 202 Strike Box. Specify 497 x 202.

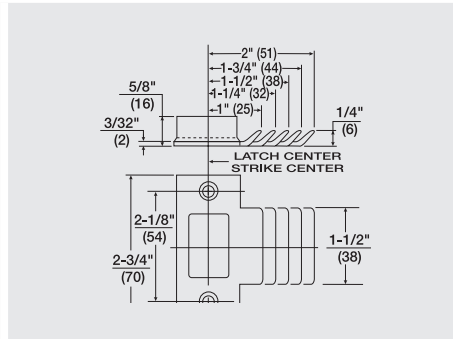

Model No. 371 T-Strike (Optional)

2-3/4" x 1-1/8" x 1-1/4" (70mm x 29mm x 32mm) lip to center available as an option. 1", 1-1/2", 1-3/4" and 2" curved lip lengths available by special order. Wrought strike box supplied.

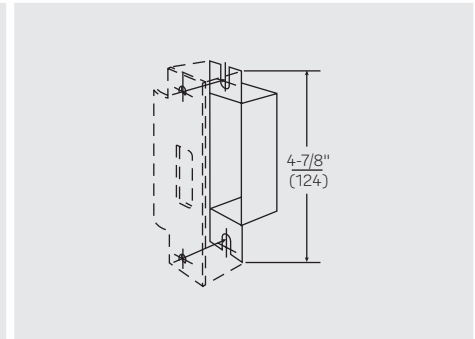

Model No. 202 Strike Box (Optional)

Available to special order. Specify 497 x 202.

Attaching Screws

(Not regularly supplied when strikes ordered separately).

For Model No. 497

#12-24 x 1" Phillips flat head combination wood and machine screws.
P/N 81-2012-0620

For Model No. 371

#8-32 x 3/4" (19mm) Phillips flat head combination wood and machine screws.
P/N 81-2012-0416





Trusted every day

Phone

1-855-557-5078

Customer Service Email

customerservice.yale@assaabloy.com

Technical Product Support Email

techsupport.yale@assaabloy.com

Order Entry Email

orders.yaleus@assaabloy.com

Fax

1-800-338-0965

Website

www.yalecommercial.com

Contact Us

U.S.A.

Yale Locks & Hardware

Address: 225 Episcopal Road

Berlin, CT 06037-4004

Tel: 1-800-438-1951

Fax: 1-800-338-0965

yalecommercial.com

Canada:

ASSA ABLOY Door Security Solutions Canada

Address: 160 Four Valley Drive

Vaughan, Ontario L4K 4T9

Tel: 1-800-461-3007

Fax: 1-800-461-8989

assaabloydss.ca

International:

ASSA ABLOY Americas International

Tel: 1-905-821-7775

Fax: 1-905-821-1429

assaabloyai.com

MicroShield®

ASSA ABLOY Group companies offer MicroShield®, an anti-microbial coating for door hardware. MicroShield uses proven silver ion-based technology from Agion®, a leading provider of antimicrobial solutions, to stem the spread of bacteria and other microbes.

MicroShield® is a registered trademark of ASSA ABLOY Access and Egress Hardware Group, Inc.



The Agion antimicrobial is not intended as a substitute for good hygiene. Coated products must still be cleaned to ensure the surfaces will be free of destructive microbes. ASSA ABLOY makes no representations or warranties, express or implied, as to the efficacy of the Agion antimicrobial. A copy of the Agion warranty is available upon request. Agion is a registered trademark of Agion Technologies, Inc., Wakefield, MA, USA.

THE YALE BRAND, with its unparalleled global reach and range of products, reassures more people in more countries than any other consumer locking solution.

THE ASSA ABLOY GROUP is the world's leading manufacturer and supplier of locking solutions, dedicated to satisfying end-user needs for security, safety and convenience.

Yale Commercial is a business associated with ASSA ABLOY Access and Egress Hardware Group, Inc., an ASSA ABLOY Group company. Copyright © 2010-2023, ASSA ABLOY Access and Egress Hardware Group, Inc. All rights reserved. Reproduction in whole or in part without the express written permission of ASSA ABLOY Access and Egress Hardware Group, Inc. is prohibited. Patent pending and/or patent www.assaabloydss.com/patents.