



# 4800LN Series

Interconnected Locks

An ASSA ABLOY Group brand

**ACCENTRA**

**ASSA ABLOY**

ASSA ABLOY is transitioning the Yale Commercial brand to ACCENTRA. This affects only the brand name; the products and product numbers will remain unchanged. Prior to May 20, 2024, products may be shipped either as Yale Commercial brand or ACCENTRA brand. Products shipping after May 20, 2024, will be branded ACCENTRA.

## performance meets style

### introduction

The Yale® 4800LN series interconnected locksets combine our key-in-lever locksets with the added safety and security of a deadbolt. From the inside, both the latchbolt and the deadbolt are retracted simultaneously in a single motion for a quick and easy egress. The 4800LN series is ideal for multi-family dwellings, assisted living facilities, office and light-duty commercial use.

### A.D.A.

The 4800LN series meets accessibility guidelines of the Americans with Disabilities Act and the requirements of the Uniform Federal Accessibility Standards and ANSI 117.1, all requiring ease of accessibility for the handicapped.

### backset

The 4800LN series is available with a 2-3/4" or 2-3/8" backset.

### cylinders

Lockset furnished standard with Yale 1812 6-pin cylinder and deadbolt furnished standard with 1814 6-pin cylinder. Optional Yale® KeyMark® cylinders available.

### deadbolt

The 4800LN series is standard with a Yale face removable deadbolt. This unique feature allows quick re-keying without disassembly.

### door thickness

Adjustable for doors 1-3/8" to 2".

### fire listings

4800LN series locksets are UL listed for use on fire doors for up to 90 minutes.

Note: Any retrofit or other field modification to a fire rated opening can potentially impact the fire rating of the opening, and Yale Locks & Hardware makes no representations or warranties concerning what such impact may be in any specific situation. When retrofitting any portion of an existing fire rated opening, or specifying and installing a new fire-rated opening, please consult with a code specialist or local code official (Authority Having Jurisdiction) to ensure compliance with all applicable codes and ratings.

### handing

Handing must be specified on Madrid 4855LN.

All other designs/functions are furnished RH. They can be changed to LH in the field by reversing the inside and outside levers.

### installation

4800LN series interconnected locks use a 4" center to center dimension and conform to ANSI/BHMA Specifications A156.115 which cover hardware preparations for steel doors and steel frames and A156.115-W which cover hardware preparations for wood doors with wood or steel frames.

### strikes

Lockset - T-Strike (Model 371) standard. Also available in full lip configurations.

Deadbolt - D245 standard, 542 optional.

### warranty

The 4800LN series carries a one-year mechanical warranty.

### windstorm

Certified (refer to local codes).



Hurricane

### contents

Introduction .....	2
Functions .....	3
Lever Designs.....	3
Cylinders .....	4-5
Latchbolts .....	5
Strikes .....	6
Ordering Information.....	7
Sample Specification .....	7

### finishes

ANSI/BHMA Code	Finish Description
605	Bright Brass, Clear Coated
606	Satin Brass, Clear Coated
609	Satin Brass, Blackened, Satin Relieved, Clear Coated**
613*	Dark Oxidized Satin Bronze, Oil Rubbed**
619	Satin Nickel Plated, Clear Coated**
625	Bright Chrome Plated
626	Satin Chrome Plated

\* **Simulated painted finish meeting ANSI/BHMA standards for wear and durability.**

\*\* **Special order finish. Additional lead times may apply. Consult customer service for more information.**

functions

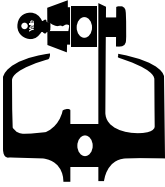
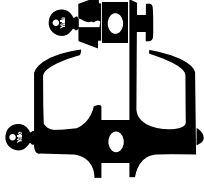
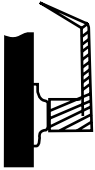
4851LN (F95)	4871LN (F97)	4855LN
<p><b>Entrance, Single Locking</b> Deadbolt operated by key from outside or by thumbturn from inside and automatically deadlocks when fully thrown. Latchbolt retracted by lever from either side. Turning inside lever retracts deadbolt and latchbolt simultaneously for immediate exit.</p>	<p><b>Entrance, Double Locking</b> Deadbolt operated by key from outside or by thumbturn from inside and automatically deadlocks when fully thrown. Outside lever unlocked by key from outside when locked by turn button on inside lever. Turning inside lever retracts deadbolt and latchbolt simultaneously for immediate exit. Latch automatically deadlocks when door is closed.</p>	<p><b>Single Dummy Trim</b> Lever acts as pull only or as matching inactive trim; no operation.</p>
		

lever designs

Augusta AU

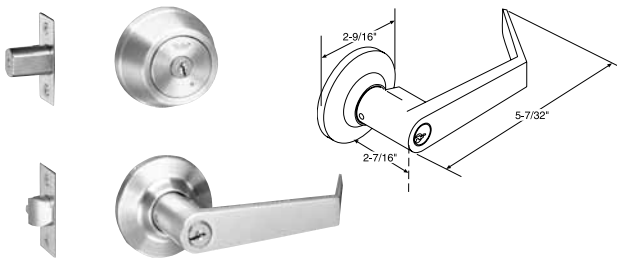

Madrid MA

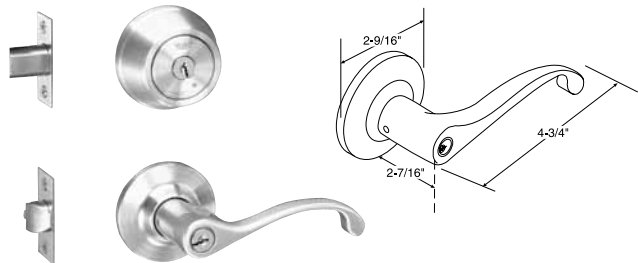

Pacific Beach PB

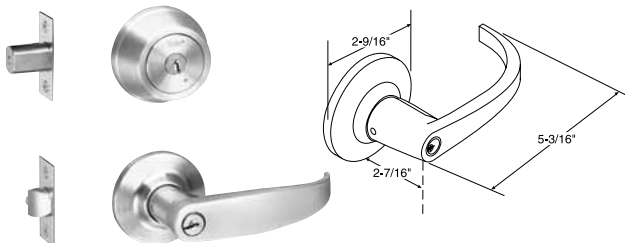

Monroe MO

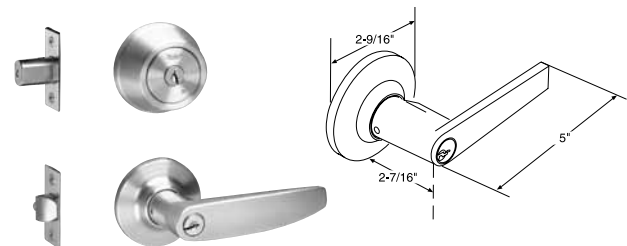

## exploded view

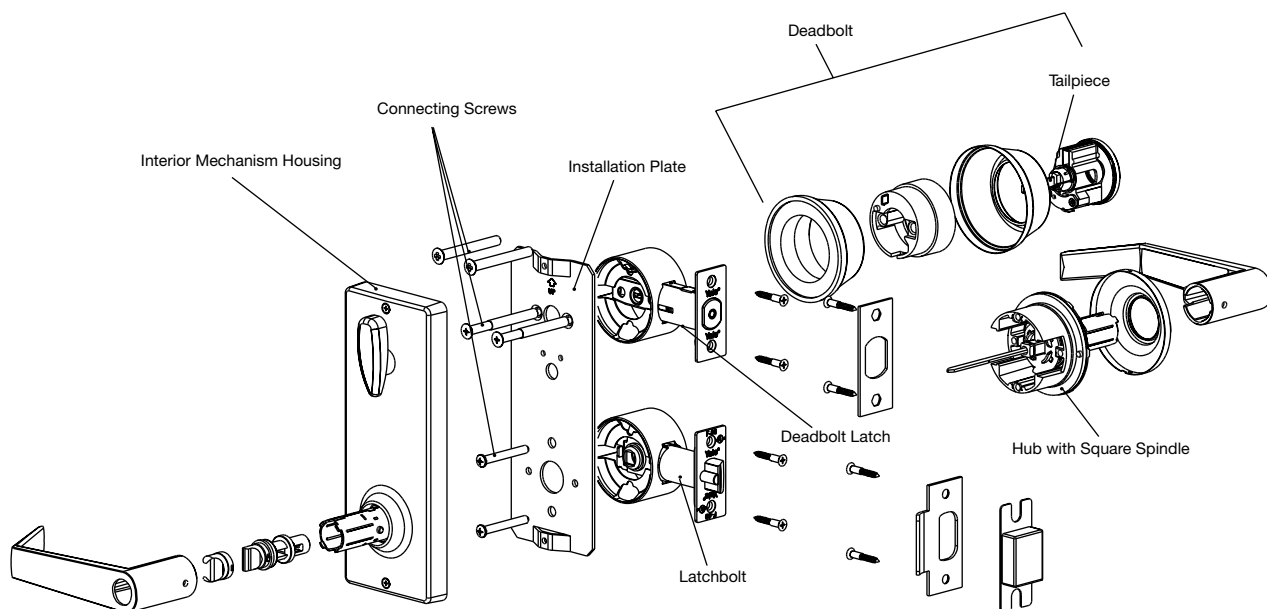

## cylinders

### cylinder options

The following selection guide indicates the correct cylinder for each locking segment:

Lockset Series: 4800LN		Types of Cylinder Mechanisms								
		Conventional		Protected Keyway		Security		High Security		
Cylinder Types	Fixed Core	6-pin	7-pin	6-pin	7-pin	6-pin	7-pin	6-pin	7-pin	
	Key-In-Lever	1812	N/A	K404	N/A	5812	N/A	N/A	N/A	N/A
	Deadbolt	1814	N/A	K202	N/A	5814	N/A	N/A	N/A	N/A
<b>Interchangeable Core</b>										
	LFIC/SFIC	N/A	N/A	N/A	N/A	N/A	N/A	N/A	N/A	

Refer to Yale® KeyMark® and/or Cylinders and Keys Catalog sections for all details and how-to-order examples.

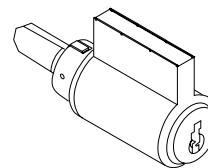

1812

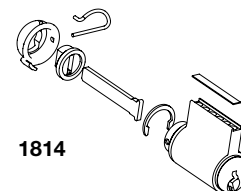

1814

### Yale® KeyMark®

For those applications requiring protected key control, Yale® KeyMark® cylinders guard against unauthorized key duplication. The *Yale KeyMark Security Leg®* keyway feature increases resistance against picking and impressioning and can easily retrofit into existing systems. For further details and availability, refer to the separate *Yale KeyMark* catalog.

## cylinders

### other manufacturers' keyway cylinders

Illustration	Description	Model Number		Number of Pins
		Lockset	Deadbolt	
	Schlage® C Keyway Cylinder. Available "0" bitted or keyed random	2812	2814	6

## latchbolts

### lockset latches

**Model No. 288DN** supplied standard with all 4800LN series locksets. Model No. 288DN latchbolt has a 2-1/4" x 1-1/8" front with a 2-3/4" backset and a 1/2" bolt throw. Optional latchbolts available to special order.

Model No.	Front	Backset	"W" Front Width	Throw	Latch Diameter*
288N	Square	2-3/8" (60mm)	1" (25mm)	1/2" (13mm)	7/8" (22mm)
288RN	Round	2-3/8" (60mm)	1" (25mm)	1/2" (13mm)	7/8" (22mm)
288DN	Square	2-3/4" (70mm)	1-1/8" (29mm)	1/2" (13mm)	7/8" (22mm)

**\*1/8" sleeve (P/N 14-0378-9001) supplied with all latchbolts to accommodate 1" preps. All 4800LN latches are deadlocking.**

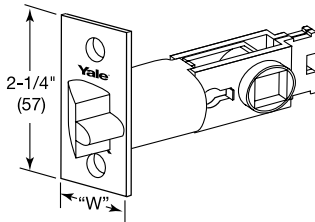

### deadbolt latches

**Model No. 212B** supplied standard with all 4800LN series deadbolts. Model No. 212B has a 2-1/4" x 1-1/8" front with a 2-3/4" backset and a 1" bolt throw. Optional deadbolt latches available to special order.

Model No.	Front	Backset *	"W" Front Width	Throw
211A	Square	2-3/8" (60mm)	1" (25mm)	1" (25mm)
211C	Round	2-3/8" (60mm)	1" (25mm)	1" (25mm)
212B	Square	2-3/4" (70mm)	1-1/8" (29mm)	1" (25mm)

**\*All deadbolt latches are adjustable between 2-3/8" and 2-3/4".**

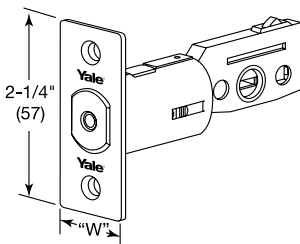

Note: 606 finish locksets are supplied with 605 finish latches and 626 finish locksets are supplied with 625 finish latches. All other finish locksets are supplied with matching latch finish.

## strikes

Yale® 4800LN locks are available with a variety of strike options. All strikes are located on the same vertical and horizontal center lines as the latchbolt and deadbolt. Some strikes are available in a variety of lip lengths to accommodate varying thickness of doors and frames. To determine the proper length of the lip, measure from the center line of the strike to the edge of the jamb, accounting for any interfering trim (i.e. wood molding) and then add 1/4" (6mm) for curved lip. All strikes are reversible. Strikes are fabricated of either brass, bronze or stainless steel, depending on the lockset trim finish. When ordering strikes separately, specify the finish required.

## lockset

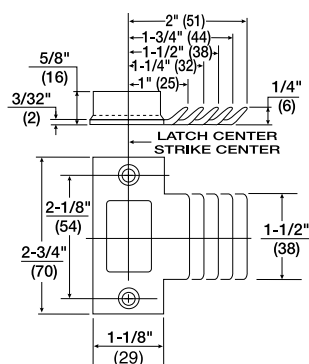

### Model No. 371 T-Strike (Standard)

1-1/4" curved lip supplied standard. 1", 1-1/2", 1-3/4", and 2" curved lip lengths available by special order. Wrought strike box supplied.

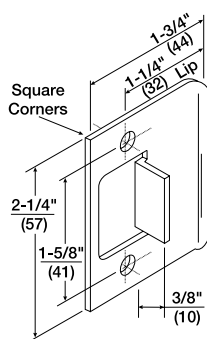

### Model No. 70S Full Lip Strike (Optional)

With full lip anti-rattle tab. Wrought strike box supplied.

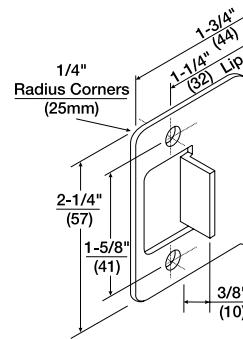

### Model No. 71S Full Lip Strike (Optional)

1/4" radius. Similar in dimensions and function to the 70S Strike but with radius corners for easy mortising by power tools. Anti-rattle tab. Wrought strike box supplied.

## deadbolt

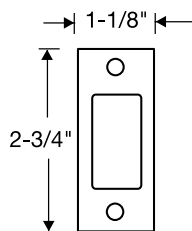

**Model No. D245**  
Deadbolt Strike  
Standard

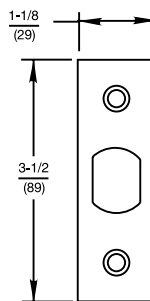

**Model No. 542**  
Deadbolt Strike  
Optional

Note: 606 finish locksets are supplied with 605 finish strikes and 626 finish locksets are supplied with 625 finish strikes. All other finish locksets are supplied with matching strike finish.

## ordering information

From this outline select the Model Number for the Yale® 4800LN Series Lockset you require.

Design See Page 3	Function See Page 3	Latch See Page 5	Strike See Page 6	Cylinder See Page 4	Door Thickness See Page 2	Finish See Page 2
		Lockset/ Deadbolt	Lockset/ Deadbolt	Lockset/ Deadbolt		
AU	4871LN	288DN / 212B	371 / D245	1812 / 1814	1-3/4"	626

## sample specification

All locksets shall be 4800LN Series Interconnected Lever Locksets.

All locksets shall have a simultaneous retraction of latchbolt and deadbolt with a single motion of turning the lever handle.

Locks shall have an interlocking tubular chassis and latchbolt. Chassis mounting screws shall be concealed and accessible only when the levers and roses are removed.

The latchbolt shall have a 1/2" (13mm) throw and shall include a deadlocking feature to inhibit manipulation when the door is locked.

All locksets and latchbolts shall be non-handed for ease of installation.

All locksets shall be adjustable for 1-3/8" (35mm) and 2" (51mm) door thickness.

Levers shall operate independently and shall have inside and outside lever return springs to prevent lever sag.

Lever handles shall be a minimum of 4-3/4" (121mm) in length and shall provide a minimum of 2-1/8" (54mm) clearance from surface of door to the inside of the lever at the midpoint.

Outside levers on keyed locksets shall be removable only when the designated key is in the cylinder.

All locksets shall be furnished with two keys. All cylinder plugs shall be brass and furnished with 6-pin chambers for master keying capabilities.

Cylinders shall be easily removed without disassembling the lockset.

All locksets shall accept Yale® KeyMark® cylinders as an option.

**Certification:**

UL 1-1/2 Hour Fire Rating

ANSI A117.1 Accessibility Code

Windstorm Certified (refer to local codes)

All locksets shall carry a one-year mechanical warranty.

## online literature and templates

---

For the latest information on Yale Locks & Hardware products, visit our website at: [www.yalelocks.com](http://www.yalelocks.com)

Click on the "Product Information" button to find:

- Catalogs
- Parts manuals
- Templates
- Specifications
- Installation instructions

Yale® customers can click on the ebusiness symbol  on the website to register for an ebusiness account to:

- Check the status of orders
- Check availability of QuickShip items
- Track your order and confirm delivery
- Receive email notification of template changes
- And More...

Or contact us at:

### U.S.A.

#### Yale Locks & Hardware

Address: 225 Episcopal Road, Berlin, CT 06037-4004

Tel: 1-800-438-1951 • Fax: 1-800-338-0965 • [www.yalelocks.com](http://www.yalelocks.com)

### Canada:

#### ASSA ABLOY Door Security Solutions Canada

Address: 160 Four Valley Drive, Vaughan, Ontario L4K 4T9

Tel: 1-800-461-3007 • Fax: 1-800-461-8989 • [www.assaabloy.ca](http://www.assaabloy.ca)

### International:

#### ASSA ABLOY Americas International

Tel: 1-905-821-7775 • Fax: 1-905-821-1429 • [www.assaabloyai.com](http://www.assaabloyai.com)

Yale Locks & Hardware is a division of Yale Security Inc., an ASSA ABLOY Group company.

Yale® is a registered trademark of Yale Security Inc., an ASSA ABLOY Group company. KeyMark® and Security Leg® are registered trademarks of Medeco Security Locks, Inc. Other products' brand names may be trademarks or registered trademarks of their respective owners and are mentioned for reference purposes only. These materials are protected under U.S. copyright laws. All contents current at time of publication. Yale Security Inc. reserves the right to change availability of any item in this catalog, its design, construction, and/or its materials. Copyright © 2005, 2013, Yale Security Inc., an ASSA ABLOY Group company. All rights reserved. Reproduction in whole or in part without the express written permission of the Yale Security Inc., an ASSA ABLOY Group company, is prohibited.

**YALE**, with its unique global reach and range of products, is the world's favorite lock.

**ASSA ABLOY** is the global leader in door opening solutions, dedicated to satisfying end-user needs for security, safety and convenience.

42527-6/13R