



5400LN Series

Grade 1 Cylindrical Lever Locks



ACCENTRA

ASSA ABLOY

ASSA ABLOY is transitioning the Yale Commercial brand to ACCENTRA. This affects only the brand name; the products and product numbers will remain unchanged. Prior to May 20, 2024, products may be shipped either as Yale Commercial brand or ACCENTRA brand. Products shipping after May 20, 2024, will be branded ACCENTRA.



Contents

Benefits & Features.....	3
How to Order.....	4
Finishes.....	5
Lever Trim.....	6
Functions.....	7-9
Electrified Options.....	10
Electrified Accessories.....	11
Cylinders.....	12-13
Latchbolts.....	14
Strikes.....	15
Sample Specification.....	16
Technical Specifications & Listings.....	17

5400LN Series Cylindrical Lever Locks

Designed for industrial and commercial use, Yale 5400LN Series heavy-duty cylindrical lockset offers rugged reliability and performance in a range of functions. With innovative features such as our Free Wheeling lever mechanism, wear-resistant chassis plates, heavy-duty lever return springs and thru-bolting, this Grade 1 workhorse is favored for a variety of applications that require reliable access every day.

Offering quality door hardware products from a brand you can trust, Yale Works for YouSM.



Benefits & Features

Benefits

- **Heavy-Duty:** Rugged Grade 1 construction offers greater reliability and resists wear-and-tear
- **Secure:** Innovative features protect against damage and vandalism
- **Versatile:** Range of functions and options offer an ideal solution for a variety of commercial applications
- **Easy installation:** Adjustable rose allows for easy adjustment on different door thicknesses
- **Strong & Reliable:** ANSI/BHMA Grade 1 certification for long-life and durability

Features

- Heavy duty construction features wear-resistant chassis plates, longer thread-locking thrubolts, lifetime warranted lever return springs and stainless steel latchbolt for exceptional strength and durability
- Free Wheeling lever mechanism prevents vandalism and reduces maintenance
- Adjustable rose support plates
- Available in 3 lever designs, 24 functions (including electrified) and 12 standard finishes
- ANSI/BHMA Certified Grade 1
- ADA compliant for ease of accessibility

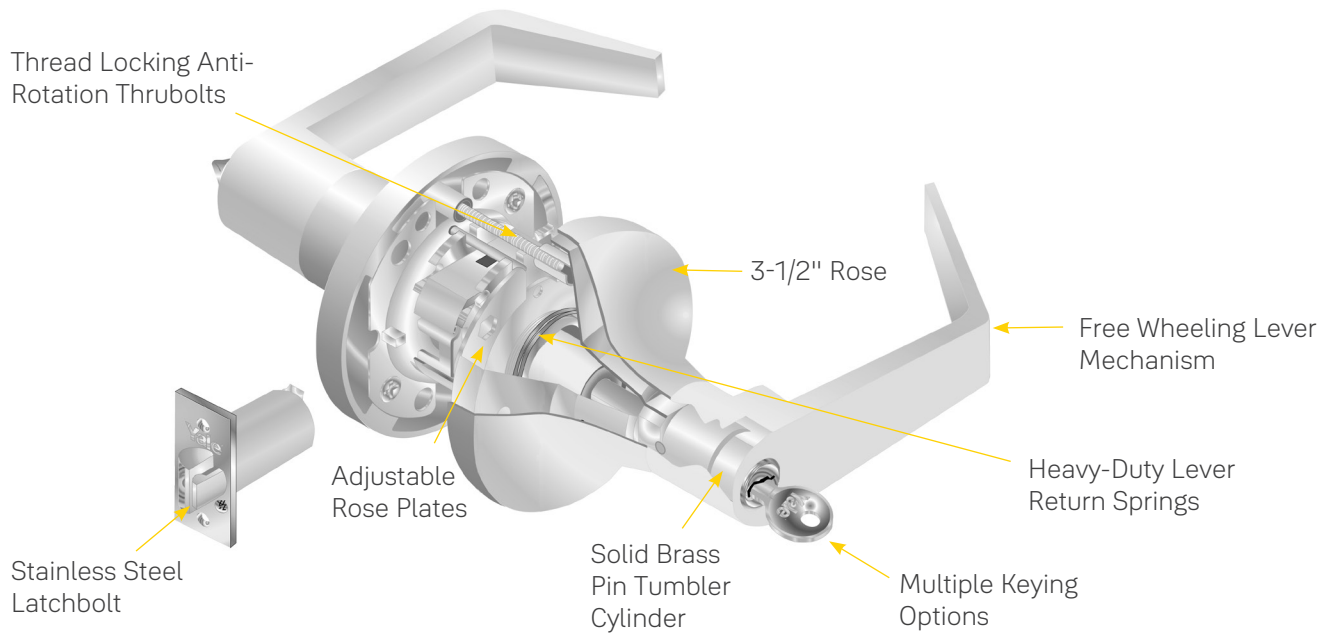

Specifications

Backset	2-3/4" standard, 3-3/4" optional
Door Thickness	Adjustable for doors 1-3/4" to 2"
Handing	Non-handed, field reversible
Latchbolt	2-3/4" backset, 1/2" throw. See page 14 for additional options.
Strike	ANSI strike 4-7/8" x 1-1/4" x 1-1/4" lip to center. See page 15 for additional options.
ANSI/BHMA	Certified Grade 1, ANSI/BHMA A156.2
UL/cUL	Listed for 3 hour fire doors
Windstorm	Certified, check local codes.
Warranty	7 years



How To Order



Trim Design	Function	Option	Hand	Latch	Strike	Cylinder	Door Thickness	Keying	Finish
AU = Augusta	5401LN	REX - See page 10 TD - See note below	Specify RH LH	See page 14 for options.	497 ANSI strike standard, see page 15 for additional options.	1802 6-pin cylinder standard, see pages 12-13 for additional options.	1-3/4" standard, see page 17 for more information.	See page 12-13	605
MO = Monroe	5402LN								606
PB = Pacific Beach	5403LN								612
	5404LN								613E
	5405LN								619
	5406LN								625
	5407LN								626
	5408LN								693
	5409LN								BSP
	5417LN								WSP
	5418LN								
	5421LN								
	5422LN								
	5425LN								
	5428LN								
	5429LN								
	5430LN								
	5439LN								
455LN									
455LN-D									
See pages 7-9 for more details.									

Ordering Example

Trim Design	Function	Option	Hand	Latch	Strike	Cylinder	Door Thickness	Keying	Finish
AU	5407LN	TD	RH	F694	497	1802	1-3/4"	KR	626

FEMA 320



With the addition of longer thru-bolt screws, the 5400LN can be used in conjunction with a Ceco StormPro® 320 door and frame and Medeco® Maxum Security deadbolts to meet the standards of the FEMA 320 Large Missile Impact test. To order these screws, add option "TD" to the model number and the correct screws will be supplied. For example: AU5407LN x TD.

Packing

Each box has a strike, paper template, combination wood and machine screws, lever release tool and easy-to-follow instructions. Cylinder functions supplied with two keys. Ten shelf boxes to a case.

Finishes



ANSI/BHMA Code Finish Description				
605 Bright Brass, Clear Coated	606 Satin Brass, Clear Coated	612 Satin Bronze, Clear Coated	613E Dark Oxidized Satin Bronze - equivalent	619* Satin Nickel Plated, Clear Coated
				
625 Bright Chrome Plated	626* Satin Chrome Plated	693 Black Painted	BSP Black Suede Powder Coat	WSP White Suede Powder Coat
				

613 and 722 finishes available by Special Product Request only. Please contact Customer Service for additional information.

*Finish available with MicroShield® antimicrobial coating, additional finishes by special application. Consult factory for availability.

MicroShield coating may vary finish color from architectural standards. MicroShield is not intended as a substitute for traditional infection control programs such as hand hygiene or use of disinfectants. Coated products must still be cleaned to ensure the surfaces will be free of destructive microbes. Yale makes no representations or warranties, express or implied, as to the efficacy of MicroShield.

Lever Trim



Augusta AU

Lever: Cast Zinc
Rose: Wrought Brass

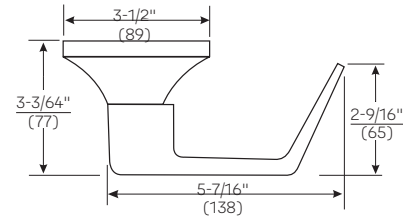

Monroe MO

Lever: Cast Zinc
Rose: Wrought Brass

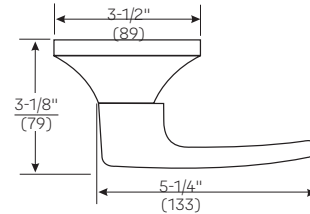

Pacific Beach PB

Lever: Cast Zinc
Rose: Wrought Brass

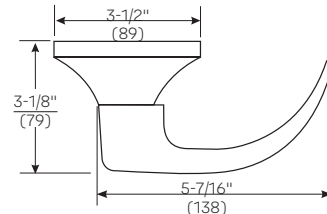

Available with large and small format interchangeable core. See page 12-13 for details.

Dimensions shown are in inches/mm.

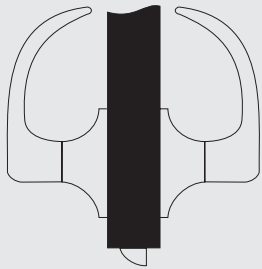
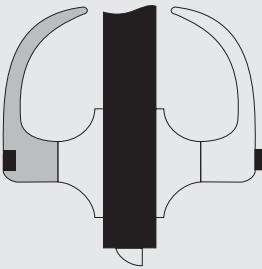
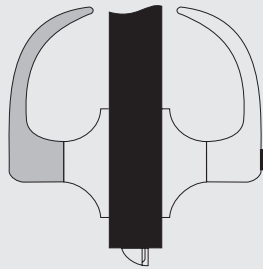
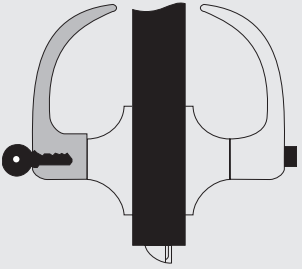
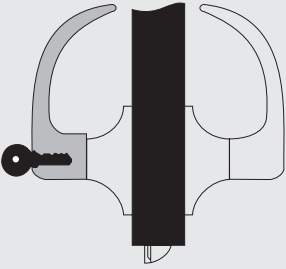
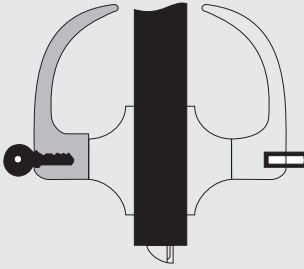

5401LN (F75)	5402LN (F76A)	5403LN (F77A)
<p>Passage or Closet Latch</p> <ul style="list-style-type: none"> • For doors that do not require locking. • Either lever operates latchbolt at all times.  <p style="text-align: center;">Outside Inside</p>	<p>Privacy, Bedroom or Bath Lock</p> <ul style="list-style-type: none"> • For lavatory or other privacy doors. • Either lever operates latchbolt unless outside lever is locked by pushbutton inside.* • Button automatically releases when inside lever is turned or door is closed. • Emergency release in outside lever. Emergency key supplied. (PN 14-5302-1053-048) • Inside lever always active.  <p style="text-align: center;">Outside Inside</p>	<p>Patio or Privacy Lock</p> <ul style="list-style-type: none"> • For exit doors with limited entry. • Deadlocking latchbolt. • Either lever operates latchbolt unless outside lever is locked by pushbutton inside.* • Button automatically releases when inside lever is turned or door is closed. • Inside lever always active.  <p style="text-align: center;">Outside Inside</p>
5404LN (F82A)	5405LN (F86)	5406LN (F92)
<p>Entry Lock</p> <ul style="list-style-type: none"> • For entrance or office doors. • Deadlocking latchbolt. • Either lever operates latchbolt (except when outside lever is locked from inside).* • Pushing button in inside lever locks outside lever. (Automatically releases when inside lever is turned or key is rotated in locked outside lever.) • Latchbolt is operated by key in outside lever or by rotating inside lever. • Inside lever always active.  <p style="text-align: center;">Outside Inside</p>	<p>Storeroom or Closet Lock</p> <ul style="list-style-type: none"> • For use on storeroom, utility, and exit doors. • Deadlocking latchbolt. • Latchbolt operated by lever inside, key in outside lever. • Outside lever always locked.* • Inside lever always active.  <p style="text-align: center;">Outside Inside</p>	<p>Service Station Lock</p> <ul style="list-style-type: none"> • Deadlocking latchbolt. • Either lever operates latchbolt. • Pushbutton in inside lever locks outside lever. (Automatically releases when inside lever is turned, door is closed or key is rotated in outside lever, except when slotted pushbutton is rotated 90° clockwise to retain outside lever in locked position.)* • Latchbolt operated by key in outside lever, inside lever always active.  <p style="text-align: center;">Outside Inside</p>

*Lever handles are Free Wheeling in locked position. Shaded area denotes Free Wheeling lever.

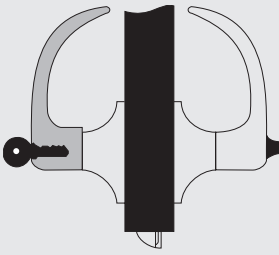

5407LN (F109)	5408LN (F84)	5409LN (F89)
<p>Entry Lock</p> <ul style="list-style-type: none"> • For entrance, general home or office doors. • Deadlocking latchbolt. • Either lever operates latchbolt (except when outside lever is locked from inside).* • Pushing turn button in inside lever locks outside lever, and automatically releases when inside lever is turned or key is rotated in locked outside lever. • Outside lever may be retained in locked position by pushing and rotating turn button 90° clockwise to a horizontal position; not released until turn button is manually returned to the vertical position. • Latchbolt is operated by key in outside lever or by rotating inside lever. • Inside lever always active.  <p style="text-align: center;">Outside Inside</p>	<p>Classroom Lock</p> <ul style="list-style-type: none"> • For classroom or utility room doors. • Deadlocking latchbolt. • Either lever operates latchbolt (except when outside lever is locked by key).* • Inside lever always active. • Outside lever locked* or unlocked only by key.  <p style="text-align: center;">Outside Inside</p>	<p>Exit Latch</p> <ul style="list-style-type: none"> • For exit doors with no-entry desired. • Deadlocking latchbolt. • Outside lever always locked.* • Inside lever always active.  <p style="text-align: center;">Outside Inside</p>
5417LN (F88)	5418LN (F110)	5421LN (F80)
<p>Apartment, Exit or Public Toilet Lock</p> <ul style="list-style-type: none"> • For office or apartment building entrance doors or lavatory doors. • Deadlocking latchbolt. • Either lever operates latchbolt (except when outside lever is locked by key from inside).* • Key in outside lever operates latchbolt. • Inside lever always active. <p>NOTE: Inside handle requires 1802S standard 6-pin cylinder.</p>  <p style="text-align: center;">Outside Inside</p>	<p>Intruder Classroom Lock</p> <ul style="list-style-type: none"> • For classroom doors. • Deadlocking latchbolt. • Either lever operates latchbolt (except when outside lever is locked by key from either side). • Outside lever remains locked upon egress. • Inside lever always active.  <p style="text-align: center;">Outside Inside</p>	<p>Communicating Lock</p> <ul style="list-style-type: none"> • For communicating or store entrance doors. • Deadlocking latchbolt. • Either lever operates latchbolt (except when key in either lever locks or unlocks the lever independently of the other).* • Should be used only in offices or rooms with multiple entries. <p>NOTE: Not available with IC core cylinders.</p>  <p style="text-align: center;">Outside Inside</p>

*Lever handles are Free Wheeling in locked position.
 Shaded area denotes Free Wheeling lever.

Functions



5422LN (F90)	5425LN	5428LN (F111)	5429LN (F113)
<p>Corridor Lock</p> <ul style="list-style-type: none"> • Deadlocking latchbolt. • Either lever operates latchbolt (except when outside lever is locked by inside pushbutton or key in outside lever). * Inside lever always active. • When locked by button, the button automatically releases when inside lever is turned or door is closed. • When locked by key, the automatic release is made inoperative and must be manually unlocked by the key.*  <p style="text-align: center;">Outside Inside</p>	<p>Privacy Lock</p> <ul style="list-style-type: none"> • For lavatory or other privacy doors. • Either lever operates latchbolt (except when outside lever is locked by inside pushbutton).* • Button automatically releases by turning inside lever or closing door. • Door can be unlocked, when necessary, by operating outside turnbutton. • No emergency key required. • Optional flush turnbutton available for outside. Specify option "FTB".  <p style="text-align: center;">Outside Inside</p>	<p>Communicating Passage Lock</p> <ul style="list-style-type: none"> • For twin communicating or exit doors where one side operation is required. • Use where space is limited. • Deadlocking latchbolt. • One lever operation. • Blank rose. • Should be used only where rooms have more than one entrance.  <p style="text-align: center;">Outside Inside</p>	<p>Communicating Classroom Lock</p> <ul style="list-style-type: none"> • For twin communicating or closet doors where one side operation or space between doors is limited. • Deadlocking latchbolt. • Blank rose. • Inside lever operates latchbolt except when lever is locked by key.* • Should be used only where rooms have more than one entrance. <p>(Not available with IC core cylinders.)</p>  <p style="text-align: center;">Outside Inside</p>
5430LN (F87)	5439LN (F112)	455LN	455LN-D
<p>Utility, Asylum or Institutional Lock</p> <ul style="list-style-type: none"> • Deadlocking latchbolt. • Latchbolt operated by key in lever from either side. • Both levers always locked.* <p>Note: Not available with IC core cylinders.</p>  <p style="text-align: center;">Outside Inside</p>	<p>Communicating Storeroom Lock</p> <ul style="list-style-type: none"> • For twin communicating or closet doors where one side operation is required or space between doors is limited. • Deadlocking latchbolt. • Latchbolt operated by key only in inside lever. • Inside lever always locked.* • Blank rose. • Should be used only where rooms have more than one entrance. <p>(Note: Not available with I.C. core cylinders)</p>  <p style="text-align: center;">Outside Inside</p>	<p>Dummy Trim</p> <ul style="list-style-type: none"> • For non-operational lever used for decorative trim.  <p style="text-align: center;">Outside Inside</p>	<p>Double Dummy Trim</p> <ul style="list-style-type: none"> • For non-operational lever used for decorative trim.  <p style="text-align: center;">Outside Inside</p>

*Lever handles are Free Wheeling in locked position. Shaded area denotes Free Wheeling lever.

Electrified Options



Operation

Electric locks provide the ability to electrically lock or unlock the outside trim from a remote location. Fail Safe locks are commonly used in stair towers to release upon fire alarm activation. Fail Secure locks are used on perimeter doors or security doors to allow ingress using access control technologies (proximity cards, keypads, etc.)

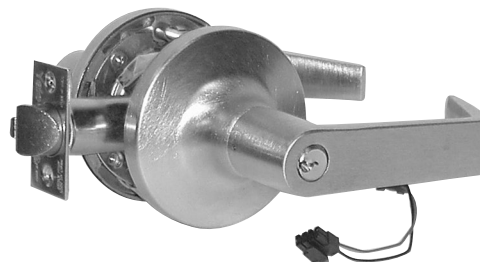

Features

- Free Wheeling lever mechanism.
- Self-contained, continuous-duty integral solenoid (allows installation in standard cylindrical prep).
- Available Fail Safe or Fail Secure.
- Available in 12 or 24 volts DC.
- 8 position ElectroLynx plug connector
- External rectifier available upon request for AC operation.
- Mechanical cylinder override.
- All 5400LN cylinder options.
- Certified ANSI/BHMA Grade 1. 
- UL listed.
- 2-year limited warranty.

Electrical Specifications

- Continuous duty solenoid
150 mA @ 24VDC
300 mA @ 12VDC
- REX (SPDT) Contact Rating:
3A @ 125 VAC
2A @ 24 VDC

ElectroLynx®

Yale® electrified 5400LN locks are equipped with ElectroLynx connectors. As a standard feature, these connectors link power from the incoming source to electrified locking products, including hinges, locks, exit devices, magnetic holders and strikes.

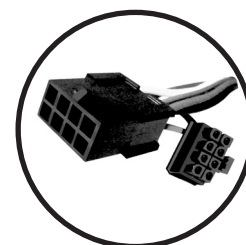









Note: Electrified door hardware with ElectroLynx connectors requires a compatible number of lead wires attached to the door hinge.

Request to Exit (REX) Option

Operating inside lever handle triggers REX switch which can be used to shunt an alarm, monitor egress or release a magnetic lock, etc.

Functions

Outside	Inside	Function	Function Description
		5490LN	Fail Safe <ul style="list-style-type: none"> • Deadlocking latchbolt by lever either side except when power on locks outside lever. • Power off/unlocks outside lever. • Inside lever always free. • Latchbolt retracted by key when power is on.
		5491LN	Fail Secure <ul style="list-style-type: none"> • Deadlocking latchbolt by lever either side except when power off locks outside lever. • Power on/unlocks outside lever. • Inside lever always free. • Latchbolt retracted by key when power is off.

Outside	Inside	Function	Function Description
		5480LN	Fail Safe <ul style="list-style-type: none"> • Deadlocking latchbolt by lever either side except when power on locks outside lever. • Power off/unlocks outside lever. Inside lever always free.
		5481LN	Fail Secure <ul style="list-style-type: none"> • Deadlocking latchbolt by lever either side except when power off locks outside lever. • Power on/unlocks outside lever. • Inside lever always free.

Electrified Accessories



BPS Power Supplies By Securitron®

Operation

Power supplies are designed to provide reliable filtered and regulated power for long life to a variety of electrified hardware components.

Product Features

- Individual output circuit breakers
- Regulated and filtered fuse protected outputs
- LEDs monitor zone status (voltage or no voltage)
- Slide switches connect or disconnect load from power (Not available on 1 Amp supplies)
- Internal Back-Up battery charging circuit
- Rugged steel enclosure
- Fire alarm interface

Listings

- UL CLASS 2

Applications (use with):

- Fail Safe cylindrical locks
- Fail Secure cylindrical locks

Ordering

Ex: BPS-24-4, BPS-12-3

Model	Input	Output	Application
BPS-24-1	120 VAC	1 Amp @ 24 VDC	2-5400LN
BPS-24-2	120 VAC	2 Amp @ 24 VDC	5-5400LN
BPS-24-4	120 VAC	4 Amp @ 24 VDC	11-5400LN
BPS-12-1	120 VAC	1 Amp @ 12 VDC	1-5400LN
BPS-12-3	120 VAC	3 Amp @ 12 VDC	3-5400LN

Consult factory for additional power supply applications.

Yale recommends McKinney®, Pemko and Securitron® for power transfer devices and other electronic accessories.

Cylinders



Cylinder Options

The following selection guide indicates the correct cylinder for each locking segment.

Lockset Series: 5400LN		Types of Cylinder Mechanisms						
		Conventional		Protected Keyway		Security		
Cylinder Types	Fixed Core	6-pin	7-pin	6-pin	7-pin	6-pin	7-pin	
	Key-In-Lever	1802	1802A	K402	K402	5802	5802A	
	Interchangeable Core							
	LFIC	1210	1220	K800	K800	5210	5220	
SFIC	A600	A600	K600	K600	N/A	N/A		

Refer to Yale® KeyMark® and/or Cylinders and Keys Catalog sections for all details and how to order examples.

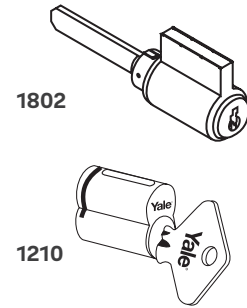

Yale® KeyMark®

For those applications requiring protected key control, Yale® KeyMark® cylinders guard against unauthorized key duplication. The Yale KeyMark Security Leg® keyway feature increases resistance against picking and impressioning and can easily retrofit into existing systems. For further details and availability, refer to the separate Yale KeyMark catalog.

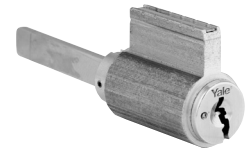

Security Cylinders

Security cylinders contain two independent locking mechanisms. The first is a traditional 6- or 7-pin tumbler mechanism with spool drivers for greatly increased picking resistance.

The second is an innovative 5-tumbler rotating disc mechanism with sidebar engagement. The rotating discs are spring loaded and block the bottom of the keyway.

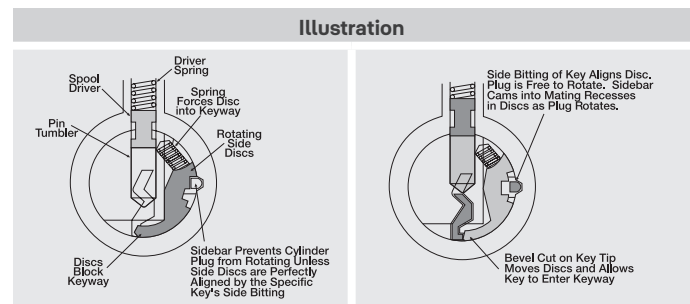

Cylinders



107S Schlage® Cylinder Adapter Kit

Used to modify Schlage cylinder for fit in the 5400LN.
P/N 14-5407-0300-048

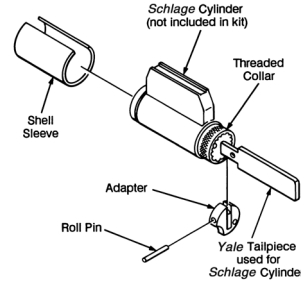

Other Manufacturer Keyway Cylinders

Illustration	Description	Model Number	Number of Pins
	Best® Keyway Cylinder. Available keyed random, master keyed or uncombined. Specify keyway A, B, C, D, E, F, G, H, J, K, L or M.	A600	6 or 7
	Corbin Russwin "L4", Corbin "60", Russwin "D1", Sargent® "LA" or Schlage® "E" Keyway. Specify keyway. Available keyed random.	3804*	6
	Schlage® "C" Keyway. Available 0-bitted or keyed random.	2802	6

***3804 cylinders require the 107S cylinder adapter kit to fit the 5400LN locksets. These cylinders are not ANSI/BHMA certified.**

Levers Accepting SFIC And Other Manufacturers' Large Format Interchangeable Cores

Illustration	Description	Prefix	Number of Pins
	SFIC (Accepts all Small Format Interchangeable Cores)	B (i.e. B-AU, B-MO, B-PB)	6 or 7
	Medeco®, ASSA® (LFIC)	M* (i.e. M-AU)	6
	Schlage® (LFIC)	SI (i.e. SI-AU, SI-PB, SI-MO)	6

***Medeco®, ASSA® option available only with AU lever. (Note: For Medeco 32 series cores.)**

LFIC = Large Format Interchangeable Core

SFIC = Small Format Interchangeable Core

Levers Accepting Other Manufacturers' Fixed Core Cylinders

Illustration	Description	Prefix	Number of Pins
	Schlage®	S (i.e. S-AU, S-MO, S-PB)	6



Plain Latchbolts

Model No. 693 supplied standard with all 5400LN series locksets without locking function. Standard plain latchbolt has a 2-1/4" (57mm) x 1-1/8" (29mm) beveled front with a 2-3/4" (70mm) backset and a 1/2" (13mm) bolt throw. Optional latchbolts with a greater backset/throw available to special order.

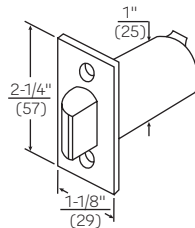

Model No.	Front	Backset	Throw	Front Width	Latch Diameter
693	Beveled	2-3/4" (70mm)	1/2" (13mm)	1-1/8" (29mm)	1" (25mm)
F693	Flat	2-3/4" (70mm)	1/2" (13mm)	1-1/8" (29mm)	1" (25mm)
3693	Beveled	3-3/4" (95mm)	1/2" (13mm)	1-1/8" (29mm)	1" (25mm)

Note: for 3/4" throw applications, only deadlocking latchbolts available.

Deadlocking Latchbolts

Deadlocking latchbolt Model No. 694 supplied standard with all 5400LN series locksets with locking function. Standard deadlocking latchbolt has a 2-1/4" (57mm) x 1-1/8" (29mm) beveled front with a 2-3/4" (70mm) backset and a 1/2" (13mm) bolt throw. Optional latchbolts with a greater backset/throw available to special order.

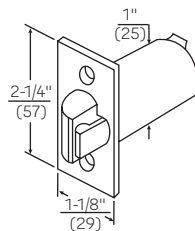

Model No.	Front	Backset	Throw	Front Width	Latch Diameter
694	Beveled	2-3/4" (70mm)	1/2" (13mm)	1-1/8" (29mm)	1" (25mm)
F694	Flat	2-3/4" (70mm)	1/2" (13mm)	1-1/8" (29mm)	1" (25mm)
3694	Beveled	3-3/4" (95mm)	1/2" (13mm)	1-1/8" (29mm)	1" (25mm)
480B	Beveled	2-3/4" (70mm)	3/4" (19mm)	1-1/8" (29mm)	1" (25mm)
F480B	Flat	2-3/4" (70mm)	3/4" (19mm)	1-1/8" (29mm)	1" (25mm)
3480B	Beveled	3-3/4" (95mm)	3/4" (19mm)	1-1/8" (29mm)	1" (25mm)

Note: for 2-3/8" backset, contact Customer Support.

Backset Extension Links

All 5400LN Series locksets are supplied with standard latchbolts of 2-3/4" (70mm) backset; optional latchbolts with a 3-3/4" (95mm) backset are available to special order. Extension links are also available for attachment to 2-3/4" (70mm) or 3-3/4" (95mm) backset latchbolts to extend the backset to the desired length.

Desired Backset	Latchbolt Backset	Order Extension List No.
5" (127mm)	2-3/4" (70mm)	481DL
6" (152mm)	3-3/4" (95mm)	481
7" (178mm)	2-3/4" (70mm)	482
8" (203mm)	3-3/4" (95mm)	482
18" (46cm)	2-3/4" (70mm)	484
19" (48cm)	3-3/4" (95mm)	484

Other extension links up to 42" (1.06m) backset are available to special order.

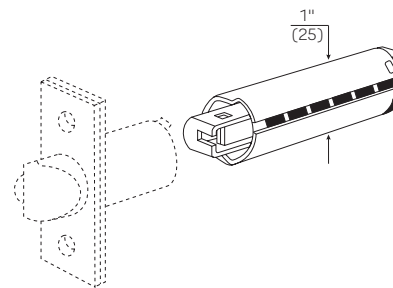

Attaching Screws

(Not regularly supplied when latchbolts ordered separately).

- **For all latchbolts**
#8-8-32 x 3/4" (19mm) Phillips flat head combination wood and machine screws
Brass - P/N 81-2022-0416*
Bronze - P/N 81-2032-0416*

- **Hollow Metal Doors**
#8 - 32 x 1" (25mm) Phillips flat head machine screw
Brass - P/N 81-0022-0420*
Bronze - P/N 81-0032-0420*

*Specify finish required.



Yale® 5400LN locks are available with a variety of strike options. All strikes are located on the same vertical and horizontal center lines as the latchbolt. Some strikes are available in special lip lengths to accommodate varying thickness of doors and frames. To determine the proper length of the lip, measure from the center line of the strike to the edge of the jamb, accounting for any interfering trim (i.e. wood molding) and then add 1/4" (6mm) for curved lip. All strikes are reversible. Strikes are fabricated of either brass, bronze or stainless steel, depending on the lockset trim finish. When ordering strikes separately, specify the finish required.

<p>Model No. 497 ANSI Strike (Standard) 1-1/4" supplied standard. 1-1/8", 1-1/2", and 1-3/4" lip lengths available by special order. For door and frames with ANSI/BHMA A156.115 preparations.</p>	<p>Model No. 371 T-Strike (Optional) 1-1/4" curved lip supplied standard. 1", 1-1/2", 1-3/4", and 2" curved lip lengths available by special order. Wrought strike box supplied.</p>	<p>Model No. 497B Blank ANSI Strike (Optional) Available to special order. Installed in frame with standard ANSI/BHMA A156.115 preparation to replace the strike when the lockset has been removed from the door.</p>	<p>Model No. 202 Strike Box for ANSI Strike (Optional) Specify 497 x 202</p>

Attaching Screws

(Not regularly supplied when strikes ordered separately).

For Model No. 371 strike

#8-8-32 x 3/4" (19mm) Phillips flat head combination wood and machine screw P/N-81-2012-0416.

For Model No. 497 strike and 497B plate

#12-12-24 x 1" (25mm) Phillips flat head combination wood and machine screw P/N-81-2012-0620.

Note: When ordering strike plates or attaching screws individually, specify the finish required; i.e. 497 x 202 x 612; #81-2012-0620 x 612.

Sample Specification



All locksets shall be 5400LN Series Grade 1 cylindrical lever locksets as assembled by Yale Locks & Hardware.

Lockset chassis shall be constructed of heavy-gauge cold-rolled steel, trivalent chrome plated to protect against rust and corrosion. Locksets shall be adjustable to fit doors between 1-3/4" (44mm) to 2" (51mm) thick.

Locksets shall be non-handed, and shall install easily without the need for specialized installation tools. Locksets shall have separate anti-rotation thrubolts in the 6 o'clock and 12 o'clock position outside the 2-1/8" face bore, and shall have no exposed mounting screws.

Locksets shall have solid one-piece, cast levers without plastic inserts, and shall be a minimum of 5-1/4" in length. Levers shall operate independently, and shall have inside and outside lever return springs. Outside levers on the keyed locksets shall be removable only when the designated key is in the cylinder.

Locksets shall have the capability of accepting 7-pin standard and interchangeable core cylinders to provide expansion capacity for large master keyed systems.

Vandal resistant levers shall be offered as a standard feature in all locking functions, and shall be Free Wheeling in the locked condition. Locksets that are rigid in the locked condition or which must require resetting (breakaway) are not acceptable.

The latchbolt shall be made of stainless steel.

All locksets shall carry a comprehensive seven-year mechanical warranty. Locksets shall carry a lifetime warranty against lever sag or lever spring breakage.

All locksets shall comply with the following certifications:

- UL 3 Hour Fire Rating
- ANSI/BHMA A156.2 Series 4000, Grade 1
- ANSI A117.1 Accessibility Code
- ANSI/BHMA A156.115 or A156.115-W Preparation

Technical Specifications and Listings



ADA

The 5400LN meets accessibility guidelines of the Americans with Disabilities Act and the requirements of the Uniform Federal Accessibility Standards and ANSI 117.1, all requiring ease of accessibility for the handicapped.



ISO 9001

Designed and manufactured under a certified ISO 9001 quality system.

ANSI/BHMA

Certified ANSI/BHMA A156.2, Series 4000 Grade 1.



Knurled Designs

Where required by the local authority, 5400LN trim can be knurled to be identifiable to the touch for blind persons. All lever designs in all finishes may be ordered knurled. Only the outside lever will be knurled unless specified otherwise.

Door Thickness

Adjustable rose support plates allow the 5400LN to easily adjust to doors from 1-3/4" to 2" thick. It can also be used on 1-3/8" thick doors by adding two spacer plates P/N 14-5401-6644. For 2-1/4" thick doors, please specify door thickness on order.

Warranty

The 5400LN Series cylindrical lever lock carries a seven-year warranty. The 5400LN carries a lifetime warranty against lever sag and lever spring breakage.

Fire Listings

UL/cUL Listed for all fire door functions up to 3 hours.

Note: Any retrofit or other field modification to a fire rated opening can potentially impact the fire rating of the opening, and Yale Locks & Hardware makes no representations or warranties concerning what such impact may be in any specific situation. When retrofitting any portion of an existing fire rated opening, or specifying and installing a new fire-rated opening, please consult with a code specialist or local code official (Authority Having Jurisdiction) to ensure compliance with all applicable codes and ratings.



Windstorm

Certified (refer to local codes). 5400LN Series can be provided to meet FEMA 320 standards. See page 4 for How to Order.



Hurricane



Tornado

Installation

5400LN Series Cylindrical Locks conform to ANSI/BHMA Specifications A156.115 which cover hardware preparations for steel doors and steel frames and A156.115-W which cover hardware preparations for wood doors with wood or steel frames.



Trusted every day

Phone

1-855-557-5078

Customer Service Email

customerservice.yale@assaabloy.com

Technical Product Support Email

techsupport.yale@assaabloy.com

Order Entry Email

orders.yaleus@assaabloy.com

Fax

1-800-338-0965

Website

www.yalecommercial.com

Contact Us

U.S.A.

Yale Locks & Hardware

Address: 225 Episcopal Road

Berlin, CT 06037-4004

Tel: 1-800-438-1951

Fax: 1-800-338-0965

yalecommercial.com

Canada:

ASSA ABLOY Door Security Solutions Canada

Address: 160 Four Valley Drive

Vaughan, Ontario L4K 4T9

Tel: 1-800-461-3007

Fax: 1-800-461-8989

assaabloydss.ca

International:

ASSA ABLOY Americas International

Tel: 1-905-821-7775

Fax: 1-905-821-1429

assaabloyai.com

MicroShield®

ASSA ABLOY Group companies offer MicroShield®, an anti-microbial coating for door hardware. MicroShield uses proven silver ion-based technology from Agion®, a leading provider of antimicrobial solutions, to stem the spread of bacteria and other microbes.

MicroShield® is a registered trademark of ASSA ABLOY Access and Egress Hardware Group, Inc.



The Agion antimicrobial is not intended as a substitute for good hygiene. Coated products must still be cleaned to ensure the surfaces will be free of destructive microbes. ASSA ABLOY makes no representations or warranties, express or implied, as to the efficacy of the Agion antimicrobial. A copy of the Agion warranty is available upon request. Agion is a registered trademark of Agion Technologies, Inc., Wakefield, MA, USA.

THE YALE BRAND, with its unparalleled global reach and range of products, reassures more people in more countries than any other consumer locking solution.

THE ASSA ABLOY GROUP is the world's leading manufacturer and supplier of locking solutions, dedicated to satisfying end-user needs for security, safety and convenience.

Yale Commercial is a business associated with ASSA ABLOY Access and Egress Hardware Group, Inc., an ASSA ABLOY Group company. Copyright © 2002-2023, ASSA ABLOY Access and Egress Hardware Group, Inc. All rights reserved. Reproduction in whole or in part without the express written permission of ASSA ABLOY Access and Egress Hardware Group, Inc. is prohibited. Patent pending and/or patent www.assaabloydss.com/patents.