



7180(F)TD

Multi-Point Exit Device Auto Latching System

An ASSA ABLOY Group brand

ACCENTRA

ASSA ABLOY

ASSA ABLOY is transitioning the Yale Commercial brand to ACCENTRA. This affects only the brand name; the products and product numbers will remain unchanged. Prior to May 20, 2024, products may be shipped either as Yale Commercial brand or ACCENTRA brand. Products shipping after May 20, 2024, will be branded ACCENTRA.



7180(F)TD | Multi-Point Exit Device Auto Latching System

introduction

The Yale® 7180(F)TD is a robust three-point auto latching system engineered to help protect lives by security community shelter entries. Extra heavy-duty steel components firmly fasten the door to the frame - at top, bottom and center latch points - reinforcing the opening to endure severe wind speeds and flying debris.

This device is ideal for Community Shelters and Safe Rooms, Corporate Campuses, Schools, Healthcare Facilities and Government Facilities.

features

- Three-point auto deadlocking
- Heavy-duty escutcheon standard
- Patented SquareBolt® security deadbolt (Pat. no. 5,605,362) designed for maximum holding power
- Available with a variety of trim styles and finishes
- Through-bolts on door for solid attachment
- Fortified with high tensile alloy Holo-Krome® fasteners
- All latching points are activated automatically when the door is closed
- Fully Integrated – 7180(F)TD is part of a complete ASSA ABLOY tornado and hurricane shelter solution with CECO StormPro® 361, CURRIES StormPro® 361 and FLEMING F-5 doors and frames and McKINNEY® SP hinges

finishes

| ANSI/ BHMA Code | Finish Description | |
|--------------------|--|---|
| 605 | Bright Brass, Clear Coated | |
| 606 | Satin Brass, Clear Coated | |
| 609 | Satin Brass, Blackened, Satin Relieved, Clear Coated | |
| 611 | Bright Bronze, Clear Coated | |
| 612 | Satin Bronze, Clear Coated | |
| 613 | Dark Oxidized Satin Bronze, Oil Rubbed ¹ | |
| 613E | Dark Oxidized Satin Bronze - equivalent | |
| 616 | Satin Bronze, Blackened, Satin Relieved, Clear Coated | |
| 619 | Satin Nickel Plated, Clear Coated | |
| 620 | Satin Nickel Plated, Blackened, Satin Relieved, Clear Coated | |
| 626 | Satin Chrome Plated (trim only) |  |
| 629 | Bright Stainless Steel | |
| 630 | Satin Stainless Steel |  |
| 693 | Black Painted | |
| 722 | Black Oxidized Bronze, Oil Rubbed ² | |

Finishes For Touchbar Covers Only

| | |
|-----------------|--------------------------------|
| BN ³ | Semi-gloss black fused polymer |
| LUM | Lumi-Lite® Photoluminescence |
| SS | Stainless Steel |



Finish available with MicroShield® antimicrobial coating, additional finishes by special application. Consult factory for availability.

1. New May1, 2010
2. Formerly 613 prior to May 1, 2010
3. Standard for device accent parts and strikes

contents

| | |
|---------------------------------------|-------|
| Introduction & Features | 2-3 |
| Applications..... | 3 |
| Functions | 4 |
| Certifications & Specifications | 5 |
| Trim Designs..... | 6 |
| 7180(F)TD Trims | 7-8 |
| SecureX® Electrified Options..... | 9-10 |
| Electric Trim..... | 11 |
| SecureX® Accessories | 12 |
| Cylinders | 13-14 |
| Accessories/Options | 15 |
| Mullions | 16 |
| Facts and Figures | 17 |
| Sample Specification | 18 |
| Ordering Information | 19 |

microshield®

7180(F)TD multi-point exit devices and trim are available with MicroShield® antimicrobial coating. *MicroShield* is a revolutionary hardware finish coating, using a silver ion based technology, which inhibits the growth of bacteria, algae, yeast, fungus, mold and mildew. *MicroShield* is non-toxic and lasts for the lifetime of the finish to which it is applied. To order, suffix option code “YMS”.



Note: *MicroShield* coating may vary finish color from architectural standards. *MicroShield* is not intended as a substitute for traditional infection control programs such as hand hygiene or use of disinfectants. Coated products must still be cleaned to insure the surfaces will be free of destructive microbes. Yale makes no representations or warranties, express or implied, as to the efficacy of the *MicroShield* antimicrobial. A copy of the *MicroShield* warranty is available upon request.



features

free-wheeling lever trim

All Yale exit device trims feature the unique Free-Wheeling lever mechanism, similar to our 5400LN cylindrical lock. This Free-Wheeling trim features a clutch mechanism which allows the lever to float down 60 degrees when operated in the locked condition, greatly improving vandal resistance.



lumi-lite®

Lumi-lite uses photoluminescence technology to provide visibility of exit doors in low-light, no light or smokey conditions. Lumi-lite absorbs ambient lighting which is then emitted when the light source is diminished or eliminated. This patent pending feature is provided as an option for the touchpad cover for 7180(F)TD multi-point exit devices. To order with device, suffix option code "LUM".



Touchpad cover comes standard with the word "EXIT" centered on the top half in approximately 1" high lettering.

warranty

- 7180(F)TD multi-point exit devcies carry a seven (7) year limited warranty.
- Heavy-duty trim carries a five (5) year limited warranty.
- Electrical options and components carry a two (2) year limited warranty.

applications

| Single Door | UL Listing | Maximum Opening (W x H) | Application | |
|---|------------|-------------------------|---|--|
| SquareBolt® x Surface Vertical Rod | | | | |
| 7180TD | Panic | 4' x 8' | Surface applied; three-point latching. | |
| 7180FTD | 3 Hr. | 4' x 8' | | |
| Pairs of Doors | UL Listing | Maximum Opening (W x H) | Application | |
| SquareBolt® x Surface Vertical Rod | | | | |
| 7180TD x 7180TD | Panic | 8' x 8' | Two independent doors with three-point latching. Swinging in the same direction with mullion. | |
| 7180FTD x 7180FTD | 3 Hr. | 8' x 8' | | |

Note: Any retrofit or other field modification to a fire rated opening can potentially impact the fire rating of the opening, and Yale Locks & Hardware makes no representations or warranties concerning what such impact may be in any specific situation. When retrofitting any portion of an existing fire rated opening, or specifying and installing a new fire-rated opening, please consult with a code specialist or local code official (Authority Having Jurisdiction) to ensure compliance with all applicable codes and ratings.

functions

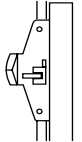
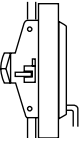
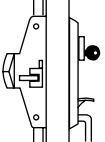
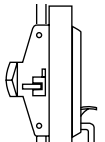
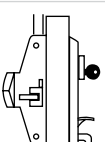
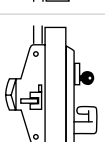
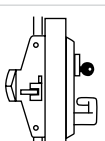
| 7180(F)TD Outside Inside | Series/ Function | ANSI No. | Function Description |
|---|----------------------------------|----------|--|
|  | Exit Only | 01 | Exit only; no trim. |
|  | Dummy | 02 | Entrance by trim when actuating bar is dogged down. |
|  | Classroom* | 05 | Entrance by thumbpiece. Key locks or unlocks thumbpiece. |
|  | Passage | 15 | Entrance by trim when latch is retracted by thumbpiece. Thumbpiece is always active, no cylinder. |
|  | Storeroom (Thumbpiece Active) | 06 | Entrance by thumbpiece only when released by key. Key removable only when locked. |
|  | Classroom* | 08 | Entrance by knob or lever. Key locks or unlocks knob or lever. |
|  | Passage | 14 | Entrance by trim when latchbolt is retracted by knob or lever. Knob or lever always active, no cylinder. |
|  | Storeroom (Lever/Knob Active) | 09 | Entrance by knob or lever only when released by key. Key removable only when locked. |

*Classroom function trims can be converted to Storeroom function by a simple field adjustment.

multi-point latching device

7180(F)TD

The 7180(F)TD is a surface applied exit device to be used on wide stile or flush doors up to 8' where three-point latching is desired.

certification/compliance

UL/cUL Listed: FVSR/FVSR7 – Panic Hardware
 GXHX/GXHX7 – Fire Exit Hardware, up to and including 3 hr. (F)
 ZHLA – Windstorm Rated Assemblies
 (4' x 8' single, 8' x 8' pairs)

ANSI/BHMA Certified: A156.3 Type 9, Grade 1 
 FEMA 361
 ICC 500



Tornado

applications

- Single swing doors
- Pairs of doors with removable mullions
- Metal doors





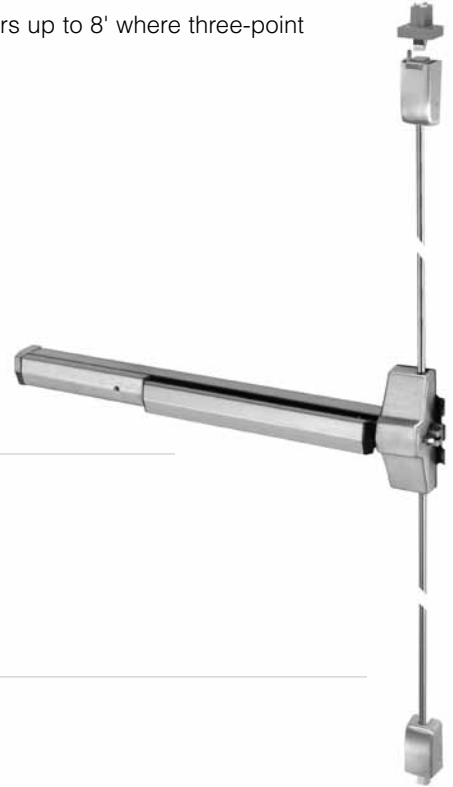





specifications

| | |
|----------------------|--|
| Door Opening Width: | -32 for 24" - 32" (60cm - 81cm) doors -36 for 30" - 36" (76cm - 91cm) doors (standard) -42 for 37" - 42" (94cm - 107cm) doors -48 for 36" - 48" (91cm - 122cm) doors Consult factory for additional lengths. |
| Door Thickness: | 1-3/4" (44mm) standard. Optional door thicknesses available to 4-1/2"; specify door thickness when ordering. |
| Minimum Stile Width: | 4-1/2" (114mm) |
| Projection: | 3-1/4" (83mm) active, 2-3/4" (70mm) dogged |
| Latchbolt: | Top: 5/8" stainless steel latch housing. Through hardened steel latchbolt, with 7/8" projection fortified with 1/4-20 steel Holo-Krome® mounting screws. Center: Patented 1" (25mm) slide projection bolt with full 3/4" (19mm) projection Bottom: 7/8" square stainless steel bolt with 5/8" projection |
| Strike: | Center: Surface mounted 3/8" (10mm) diameter roller strike, complete with positive locking plate and shims, assuring low friction relocking for a long, trouble-free life. For doors with 1/2" (13mm) or 5/8" (16mm) stop. Adjustable to compensate for shrinkage and swelling of door. 3-1/2" x 1-1/4" (89mm x 32mm). Bottom: Black nylon coated stainless steel, 2-3/4" (70mm) x 2-5/16" (59mm) x 1/2" (13mm) |
| End Cap: | Standard reinforced end cap consists of a solid steel plate welded to the end of the bracket. Evenly distributes impact forces over a larger surface area, eliminating point loading. |
| Fasteners: | Sex nuts and bolts supplied standard |
| Trims: | 620F series escutcheon trim, 630F series pull/thumbpiece trim, 680F series offset pull trim. See pages 7-8. |
| Dogging: | Hex key dogging supplied standard on panic devices |
| Options: | Cylinder dogging, MicroShield®, Lumi-Lite® |
| Electrified: | See pages 9-12 |
| Warranty: | 7-year limited |



























trim designs

standard

| | | | |
|--|--|--|--|
| <p>Arcadia AR</p>  <p>Projection: 3-1/4" (82mm)</p> | <p>Augusta AU</p>  <p>Projection: 2-5/8" (61mm)</p> | <p>Carmel CR</p>  <p>Projection: 3-1/8" (79mm)</p> | <p>Jefferson JN</p>  <p>Projection: 2-9/16" (65mm)</p> |
| <p>Monroe MO</p>  <p>Projection: 3" (76mm)</p> | <p>Pacific Beach PB</p>  <p>Projection: 3-5/16" (84mm)</p> | <p>Pinehurst PN</p>  <p>Projection: 3-1/16" (78mm)</p> | <p>Virginia VI</p>  <p>Projection: 3-1/8" (79mm)</p> |
| <p>Hampton HA</p>  <p>Projection: 3-3/8" (86mm)</p> | <p>Copenhagen CO</p>  <p>Projection: 3-1/2" (90mm)</p> | <p>Litchfield LF</p>  <p>Projection: 2-7/8" (73mm)</p> | |

Note: Projection dimensions are provided using the 620F series escutcheon plates.

Reflections®

| | | | | | | | | | |
|-----------------|---|---|---|---|---|--|---|---|---|
| | TB | UB | TC | UC | | | | | |
| Hudson |  |  |  |  | | | | | |
| Projection | 3-1/16" (78mm) | 3-1/4" (83mm) | 3" (76mm) | 3-7/16" (87mm) | | | | | |
| | TE | TI | | | | | | | |
| Danube |  |  | | | | | | | |
| Projection | 3" (76mm) | 3-3/8" (85mm) | | | | | | | |
| | TG | TO | TJ | TK | | | | | |
| Seine |  |  |  |  | | | | | |
| Projection | 2-13/16" (71mm) | 3-1/2" (89mm) | 3-1/16" (78mm) | 3-1/4" (83mm) | | | | | |
| | TM | TN | TP | TR | TS | TQ | | | |
| Thames |  |  |  |  |  |  | | | |
| Projection | 3-1/16" (78mm) | 3-1/16" (78mm) | 3-5/16" (84mm) | 3-1/16" (78mm) | 3-1/8" (80mm) | 3-1/16" (78mm) | | | |
| | TT | TU | TV | TW | UW | TX | UX | TU | TZ |
| Victoria |  |  |  |  |  |  |  |  |  |
| Projection | 2-11/16" (68mm) | 3-1/4" (83mm) | 3-1/2" (89mm) | 3" (76mm) | 3-7/16" (87mm) | 3-5/8" (92mm) | 3-7/16" (87mm) | 3-5/16" (84mm) | 3-7/16" (87mm) |

Note: Projection dimensions are provided using the 620F series escutcheon plates.





7180(F)TD | Multi-Point Exit Device Auto Latching System

7180(F)TD trims

620F series escutcheon trim

- Certified ANSI/BHMA A156.3, Grade 1. 
- Trim through-bolts to exit device for strength.
- Beveled sides improve attack resistance.
- Solid forged escutcheon and Free-Wheeling trim resists vandalism and abuse.
- Flush cylinder in 6-pin applications for additional security.
- 1-3/4" (44mm) door standard. For doors through 2-1/4" (57mm) or shim-mounted devices, specify on order.
- Dimensions: 3" x 10-1/4" x 13/16" (76mm x 260mm x 19mm).
- Cylinders not included. See page 13 for cylinder options.
- Available with AR, AU, CR, JN, MO, PB, PN, VI, HA lever designs and CO, LF knob designs. See page 6.
 - Finishes: 605, 606, 609, 611, 612, 613, 613E, 616, 619, 620, 626, 629, 630, 693, 722
- Available with Reflections® lever designs. See page 6.
 - Finishes: 605, 606, 611, 612, 613, 613E, 619, 626, 629, 630, 722
- Trim ordering example: AU626F x 626 x RHR.
- 5-year limited warranty.

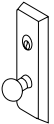
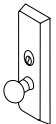
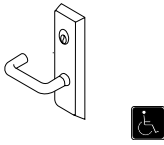
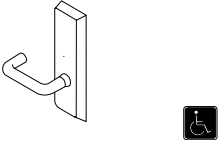
|  | |  |  |  |  | |  | | | |
|---|----------|---|---|---|--|-----------------------------------|---|---------|--------------------------|-------------------|
| Application | Cylinder | Exit Only Blank Plate | Classroom/ Storeroom Cylinder Controls Knob | Passage Active Knob | Dummy Trim Rigid Knob | Classroom Cylinder Controls Lever | Storeroom Cylinder Controls Lever | Passage | Dummy Trim Free-Wheeling | Dummy Rigid Lever |
| 7180(F)TD | Rim | 620F | 622F ¹ | 624F | 625F | 626F | 626F ¹ | 628F | 628F ¹ | 629F |
| ANSI | | 01 | 08/09 | 14 | 02 | 08 | 09 | 14 | 02 | 02 |

¹ 09 and Free Wheeling 02 achieved with single trim modification at installation.
 For 626, 629 & 630 finishes the escutcheon is plated to simulate stainless steel.
 For 629 & 630 finishes the standard levers are plated to simulate stainless steel.
 Optional door thickness available up to 4-1/2", specify on order.







7180(F)TD | Multi-Point Exit Device Auto Latching System

7180(F)TD trims

630F series pull/thumbpiece trim

- Certified ANSI/BHMA A156.3, Grade 1. **BHMA CERTIFIED**
- Trim through-bolts to exit device for strength.
- Beveled sides improve attack resistance.
- Solid forged escutcheon resists vandalism and abuse.
- Flush cylinder in 6-pin applications for additional security.
- 1-3/4" (44mm) door standard. For doors through 2-1/4" (57mm) or shim-mounted devices, specify on order.
- Plate Dimensions: 2-3/4" x 15-1/2" x 5/8" (70mm x 394mm x 16mm).
- Pull Dimensions: 6-7/16" (164mm) on centers x 2-1/8" (54mm) projection.
- Cylinders not included. See page 13 for cylinder options.
- Finishes: 605, 606, 609, 612, 613, 613E, 616, 619, 620, 626, 629, 630, 693, 722
- Trim ordering example: 630F x 630
- 5-year limited warranty.

|  |  |  |  |  | | |
|---|---|---|---|---|-----------------------|------------------------|
| Applications | Cylinder | Exit Only Blank Plate | Classroom Cylinder Controls T-Piece | Storeroom Cylinder Controls T-Piece | Dummy Trim Pull Plate | Passage Active T-Piece |
| 7180(F)TD | Rim | 630F | 633F | 633F ¹ | 634F | 635F |
| ANSI | | 01 | 05 | 06 | 02 | 15 |

¹06 achieved with single trim modification at installation.
 Optional door thickness available up to 4-1/2", specify on order.
 For 626, 629 & 630 finishes the escutcheon is plated to simulate stainless steel.

680F series offset pull trim

- 1-3/4" (44mm) door standard. For doors through 2-1/4" (54mm) or shim-mounted devices, specify on order.
- Plate Dimensions: 3" x 10-1/4" x 13/16" (76mm x 260mm x 21mm)
- Pull Dimensions: 7-1/4" (184mm) on centers x 2-13/32" (61mm) projection.
- Trim through-bolts to exit device for strength.
- Beveled sides improve attack resistance.
- Solid forged escutcheon resists vandalism and abuse.
- Finishes: 605, 606, 609, 611, 612, 613, 613E, 616, 619, 620, 626, 629, 630, 693, 722
- Trim ordering example: 680F x 630 x LHR
- 5-year limited warranty

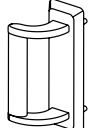
|  |  |
|---|---|
| Applications | Exit Only Blank Plate |
| 7180(F) TD | 680F |
| ANSI | 02 |

For 626, 629 & 630 finishes the escutcheon is plated to simulate stainless steel.



SecureX® electrified options

The Yale® 7180(F)TD multi-point latching exit devices offer a complete range of electrical options. A continuity in appearance, security and functions with the 7000 Series mechanical exit device is maintained. These electrified exit devices may be integrated into the monitoring security and alarm systems of most buildings.

electrified options

| Model # | Exit Device Description | A | B | D | G | H | O | P | S | SAFE | SECURE | 690F | 691F |
|-----------|---------------------------|---|---|---|---|---|---|---|---|------|--------|------|------|
| 7180(F)TD | Multi-Point Device (Wide) | | x | | | | x | | | | | x | x |

electrified hardware option descriptions

| | | | |
|---|---------------------|------|------------------------------|
| B | Touchbar Monitor | 690F | Fail Safe Electrified Trim |
| O | Trim Monitor Switch | 691F | Fail Secure Electrified Trim |



What normally took an hour or more to connect now takes minutes. Yale electrified exit devices and trims are equipped with ElectroLynx® connectors. As a standard feature, these “plug & play” connectors link power from the incoming source to electrified locking products, including hinges, locks, exit devices, magnetic holders and strikes.

Note: Electrified door hardware with ElectroLynx® connectors require a compatible number of lead wires attached to the door hinge.

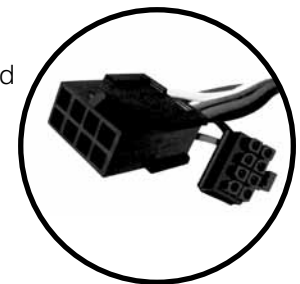

SecureX® electrified options

touchbar monitor “B”

Provides indication of the pushpad being depressed. Used as a Request to Exit switch to shunt alarm systems, release electromagnetic locks or monitor egress.

Electrical Specifications: SPDT contacts rated 4 amp @ 250VAC

Listings: UL/cUL listed for panic and fire exit hardware.

Ordering: Suffix “B” to the Model Number. Ex: Panic = 7180TDB, Fire = 7180FTDB

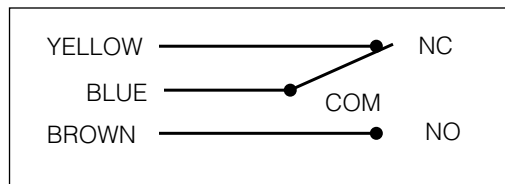

trim monitor switch “O”

Provides indication of the trim being operated from the outside. Used as a Request to Enter signal switch to shunt alarms, also used to monitor entry.

Electrical Specifications: SPDT contacts rated 5 amp @ 250VAC

Listings: UL/cUL listed for panic and fire exit hardware.

Ordering: Suffix “O” to the Model Number. Ex: Panic = 7180TDO, Fire = 7180FTDO

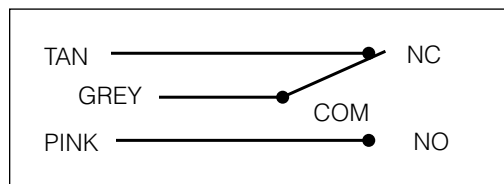

SecureX® electrified options

electric trim

The electrified 600 series heavy-duty trim provides electric locking and unlocking of trim. Ideal for door control where increased security is necessary at all times, while meeting life safety codes. Electric trim is ideal for many applications, including stairwell towers, high-security areas, schools, hospitals, and factories.



functions

690F Trim - Fail Safe

- Lever is locked when power is on (Free-Wheeling)
- Power off allows entry from trim
- Inside device is always active for egress
- Mechanical key override (09 Function - Key allows lever to retract latchbolt. Key can only be removed in locked position)

691F Trim - Fail Secure

- Lever is locked when power is off (Free-Wheeling)
- Power on allows lever activation for entry
- Inside device is always active for egress
- Mechanical key override (09 Function - Key allows lever to retract latchbolt. Key can only be removed in locked position.)

features

- Accepts all standard and Reflections® decorative lever designs
- Plug connector with 4' wire lead (Exit device is used as wire raceway, not door)
- Key Override - Requires rim cylinder (sold separately)

electrical specifications

- 330 mA @ 24 Volts
 - SM - Security Monitor Switch
- SPDT contacts rated 4 amps @ 250VAC
 - Voltage: 24 VAC/VDC only
 - BPS series power supplies recommended.

options

- SM - Security Monitor. A SPDT switch that monitors the position of the solenoid (lock and unlock status).
- EX - Trim gasket for exterior applications.

SecureX® accessories

BPS power supply

Operation

Power supplies are designed to provide reliable filtered and regulated power for long life to a variety of electrified hardware components. Recommended for electric trim.

Features

- Individual output circuit breakers
- Regulated and filtered fuse protected outputs
- LEDs monitor zone status (voltage or no voltage)
- Slide switches connect or disconnect load from power (Not available on 1 Amp supplies)
- Internal Back-Up battery charging circuit
- Rugged steel enclosure
- Fire alarm interface

Electrical Specifications

- Inputs: 120VAC
- Outputs: 24 VDC @ 1 Amp, 2 Amp or 4 Amp, Filtered and regulated outputs

Listings

- UL-cUL CLASS 2
 - Signal Appliances
 - Access control System Units
 - Special Locking Arrangements - Component
- CE



Note: Batteries are not included with the BPS power supply.

| Model | Enclosure | Input | Output |
|----------|--|--------|------------------|
| BPS-24-1 | 12" (304mm) x 9" (229mm) x 4" (102mm) | 120VAC | 1.0 Amp @ 24 VDC |
| BPS-24-2 | 14" (356mm) x 14" (356mm) x 4" (102mm) | 120VAC | 2.0 Amp @ 24 VDC |
| BPS-24-4 | 15" (381mm) x 18" (457mm) x 6" (152mm) | 120VAC | 4.0 Amp @ 24 VDC |



cylinders

rim

The following chart details rim cylinders for use with 620F, 630F and 690F trims:

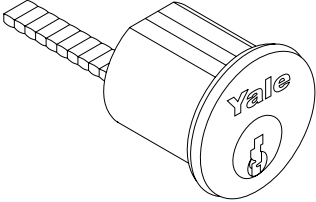
|  | | | | Collar Requirements* | |
|---|---|--------|----------|----------------------|-----------|
| | | | | 620F/690F | 630F |
| Model # | Description | Pins | Length | | |
| 1109 | Standard Fixed Core | 6 | 1-1/4" | No Collar | No Collar |
| 1109 | Standard Fixed Core | 7 | 1-7/16" | | KP4 |
| 1709 | CMK | 6 | 1-15/16" | 1765.250 | 1765.250 |
| 1709 | CMK | 7 | 1-5/8" | | 1765.406 |
| 1193 | LFIC Complete | 6 | 1-7/16" | | 1765.250 |
| 1193 | LFIC Complete | 7 | 1-5/8" | 1765.344 | 1765.406 |
| 5109 | Security Fixed Core | 6 | 1-9/16" | No Collar | 1765.250 |
| 5109 | Security Fixed Core | 7 | 1-7/16" | | |
| U5109 | High Security Fixed Core | 6 | 1" | | No Collar |
| U5109 | High Security Fixed Core | 7 | 1" | | |
| 5193 | Security LFIC Complete | 6 | 1-7/16" | 1765.250 | 1765.250 |
| 5193 | Security LFIC Complete | 7 | 1-5/8" | 1765.344 | 1765.406 |
| K300 | Yale® KeyMark® Standard Fixed Core | 6 | 1-1/8" | KP4 | 1765.250 |
| K300 | Yale KeyMark Standard Fixed Core | 7 | | | |
| K840/K880 | Yale KeyMark LFIC Complete / Housing Only | 6 | 1-7/16" | 1765.406 | 1765.500 |
| K840/K880 | Yale KeyMark LFIC Complete / Housing Only | 7 | 1-5/8" | 1765.563 | 1765.719 |
| K640/K680 | Yale KeyMark SFIC Complete / Housing Only | 6 | 1-1/4" | KP4 | 1765.250 |
| K640/K680 | Yale KeyMark SFIC Complete / Housing Only | 6 or 7 | 1-3/8" | 1765.187 | 1765.406 |
| A640/K680 | Best® Keyway SFIC Complete / Housing Only | 6 | 1-1/4" | KP4 | 1765.250 |
| A640/K680 | Best® Keyway SFIC Complete / Housing Only | 6 or 7 | 1-3/8" | 1765.187 | 1765.406 |
| 2109 | Schlage® "C" Keyway Fixed Core Available 0-bitted or keyed random. | 6 | 1-1/8" | No Collar | No Collar |

*Based on 1-3/4" door thickness.

LFIC = Large Format Interchangeable Core

SFIC = Small Format Interchangeable Core

cylinders

mortise

The following chart details mortise cylinders for use with cylinder dogging:

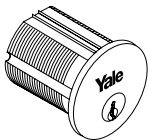

| Model # | Description | Pins | Length | Cylinder Dogging | |
|-----------|---|--------|----------|------------------|-----------|
| | | | | Cam | Collar |
| 2153 | Standard Fixed Core | 6 | 1-1/8" | 2160 | No Collar |
| 2153 | Standard Fixed Core | 7 | 1-1/4" | | 1765.156 |
| 2196 | LFIC Complete | 6 | 1-1/2" | | 1765.406 |
| 2197 | LFIC Complete | 7 | 1-11/16" | | 1765.594 |
| 5153 | Security Fixed Core | 6 | 1-1/8" | | No Collar |
| 5153 | Security Fixed Core | 7 | 1-1/4" | | 1765.156 |
| U5153 | High Security Fixed Core | 6 | 1-1/8" | | N/A |
| U5153 | High Security Fixed Core | 7 | 1-1/4" | | |
| 5196 | Security LFIC Complete | 6 | 1-1/2" | | 1765.406 |
| 5197 | Security LFIC Complete | 7 | 1-11/16" | | 1765.594 |
| K100 | Yale® KeyMark® Standard Fixed Core | 6 or 7 | 1-1/8" | KC1 | No Collar |
| K820/K860 | Yale KeyMark LFIC Complete / Housing Only | 6 | 1-1/2" | | 1765.406 |
| K820/K860 | Yale KeyMark LFIC Complete / Housing Only | 7 | 1-11/16" | | 1765.594 |
| K620/K660 | Yale KeyMark SFIC Complete / Housing Only | 6 | 1-1/4" | | 1765.156 |
| K620/K660 | Yale KeyMark SFIC Complete / Housing Only | 6 or 7 | 1-3/8" | | 1765.281 |
| A620/K660 | Best® Keyway SFIC Complete / Housing Only | 6 | 1-1/4" | | 1765.156 |
| A620/K660 | Best® Keyway SFIC Complete / Housing Only | 6 or 7 | 1-3/8" | | 1765.281 |
| 2553 | Schlage® "C" Keyway Fixed Core. Available 0-bitted or keyed random. | 6 | 1-1/8" | 2160 | No Collar |

Based on 1-3/4" door thickness.

LFIC = Large Format Interchangeable Core.

SFIC = Small Format Interchangeable Core.

NA = Application Not Available

cylinder collars

If required, cylinder collar size must be specified.

| | | |
|---|---|---|
| | | |
| <p>1765 Recessed Cylinder Collar "A" Dimension: Thicknesses from 1/16" (2mm) to 1-15/32" (37mm) as required. Material: Brass, Bronze</p> | <p>KP3 Wave Washer (Furnished standard with 1765 collar for Yale® KeyMark® cylinders and 630F series trim).</p> | <p>KP4 Flush Mount Cylinder Collar Material: Brass, Bronze</p> |



accessories/options

strikes

| | |
|---|--|
| | |
| <p>757FTD Center - Surface mounted 3/8" (10mm) diameter roller strike. Supplied with locking plate, two 1/16" (1.6mm) shims, 2 each #12-24 x 1" and 2 each #12-24 x 1-1/4" screws. Also includes block strike pack used for single door applications with 4 each #12-24 x 1-5/8" screws.</p> | <p>795 Bottom - Black nylon coated stainless steel, 2-3/4" (70mm) x 2-5/16" (59mm) x 1/2" (13mm). Supplied with 3 each steel anchors and 3 each 1/4-20 x 2" screws.</p> |

anti-pry bracket kit

All 7180(F)TD devices are furnished standard with an anti-pry bracket and shims. When the door is in the closed position, the anti-pry bracket interlocks in position between the exit device strike and frame preventing the strike and exit device latch from being separated. Kit includes anti-pry bracket, end cap shim, top/bottom latch shims and rod guide shims. Black powder coat finish. To order separately, specify model number 725FTD.

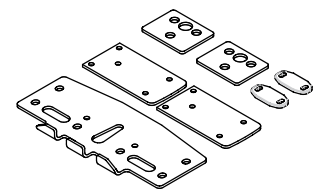

cylinder dogging

Cylinder dogging is available for all panic-listed exit devices only. Requires use of 1-1/8" mortise cylinder. When ordered with a device, cylinder must be ordered separately. (See How to Order, "Fourth Digit", page 19.) Cylinder dogging kit available; specify 715-48 (cylinder not included with this kit).

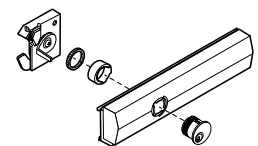

specialty fasteners

TORX® Security Screws:

Available for factory product orders.

long tailpiece kit

Long tailpiece kit for use with escutcheon series trim, up to 4-1/2" thick doors.

| Door Thickness | Trim Type | Part Number |
|-----------------|---------------------------|------------------|
| 2" - 2-1/2" | 620F and 630F Series Trim | 81-9500-1665-000 |
| 2-1/2" - 3-1/2" | 620F and 630F Series Trim | 81-9500-1635-000 |
| 3-1/2" - 4-1/2" | 620F and 630F Series Trim | 81-9500-1636-000 |

Specify part number to order.

mullions

M200FWS removable mullion

M200FWS steel mullions are for use with 7180(F)TD multi-point exit devices. Mullions may be field cut to fit opening. Red primer finish.

- 3 hour fire rated.
- Certified hurricane and tornado resistant (refer to local codes).
- Tubular steel, 2" x 3" (51mm x 76mm). Specify 7' or 8'.



Hurricane



Tornado

options

M203 Spacer Block

Recommended for double rabbeted frames where the stop face width is less than the mounting hole spacing or for applications with 5-3/4" (146mm) or less door frames.

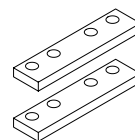

M204 Angle Bracket

Recommended for any header configuration with less than 3" (76mm) of mounting surface.

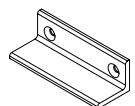

102S mullion stabilizer kit

Recommended for high openings and whenever door movement must be further restricted. To order separately, specify 102S.

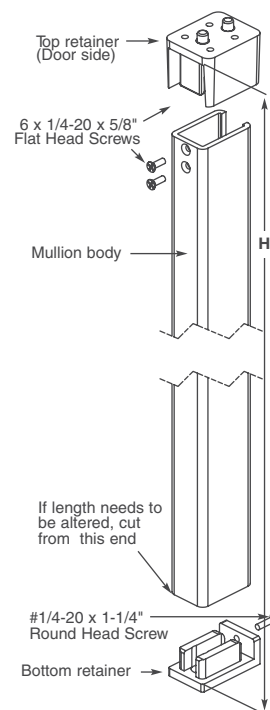

M200FWS

facts and figures

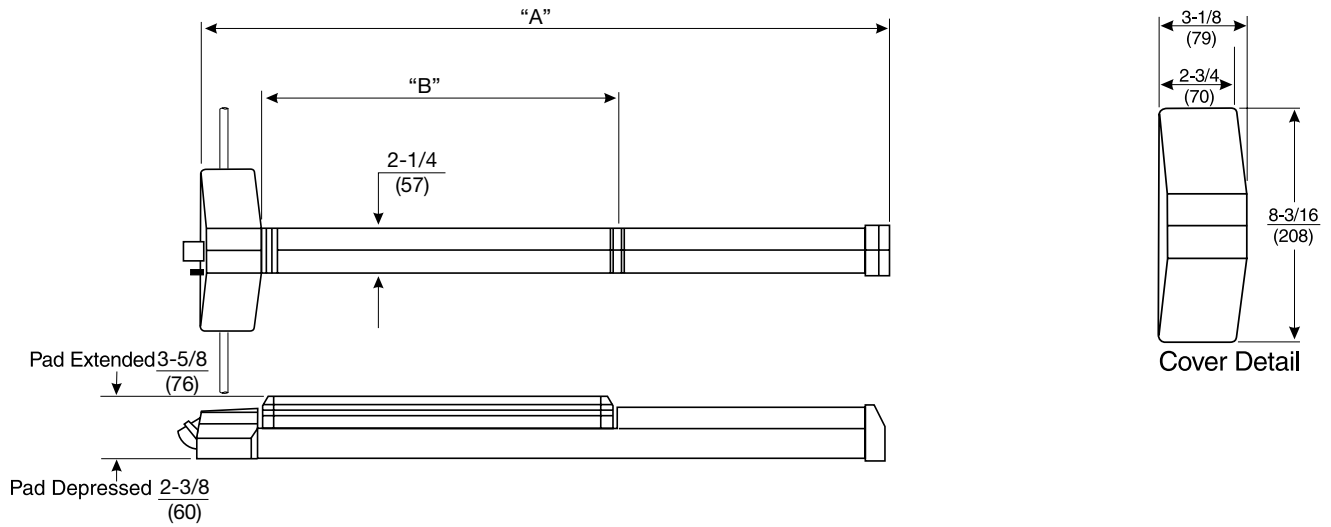

| Model | "A" | "B" |
|--------------|------------------|-------------|
| 7180(F)TD-32 | 28-7/8" (733mm) | 18" (457mm) |
| 7180(F)TD-36 | 32-7/8" (835mm) | 18" (457mm) |
| 7180(F)TD-42 | 38-7/8" (987mm) | 24" (610mm) |
| 7180(F)TD-48 | 44-7/8" (1130mm) | 24" (610mm) |

trim dimensions

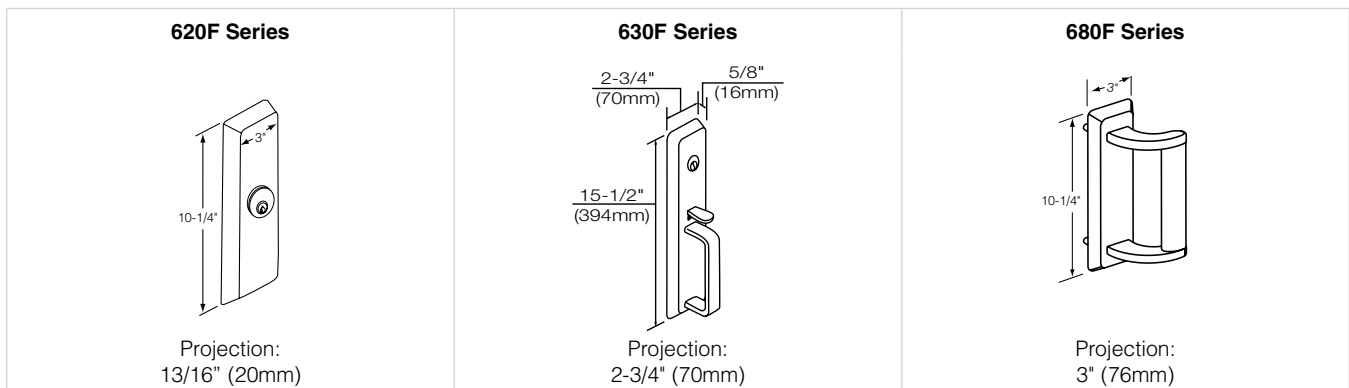

sample specification

Multi-point exit device systems: Multi-point exit device auto deadbolt locking systems are engineered for use on entry door applications at windstorm safe shelter locations. Fortified steel construction secures the door to the frame at top, bottom and center latching positions. All three latching points shall be automatically activated when the device is closed and retracted with one single motion of pushbar operation upon exiting.

1. Provide three point locking system as part of an integrated door, frame and exit hardware assembly, UL Listed and certified in accordance with FEMA 361 and ICC 500.
2. Provide units manufactured in compliance with NFPA 80 and NFPA 101, UL10b or UL10c approved for up to 3 hour fire rated assemblies.
3. Latchbolt construction:
 - a. Center latch: 3/4"(19mm) throw stainless steel slide action deadbolt with positive deadlocking by auxiliary bolt.
 - b. Top latch: Through-hardened steel latchbolt with 7/8" projection, and 5/8" stainless steel latch housing secured with 1/4"-20 Holo-Krome fasteners.
 - c. Bottom Latch: 7/8" square stainless steel bolt with 5/8" projection.
4. Provide devices with heavy-duty, brass escutcheon trim and solid cast levers matching the design style and architectural finishes as the balance of the lockset and latches specified.
5. Heavy duty primed steel mullion is required for use with 7180(F)TD when securing paired openings up to 8'0" x 8'0".
6. Cylinders and keying: Refer to separate part 2 Products - "Keying" paragraph sub-section for related keying requirements.
7. Provide seven year limited warranty for three point locking system.

ordering information

| 7 | 1 | 8 | X | Mechanical/Electrical | Size | Design | Trim | Finish | Other Info. |
|---|---|---|--|--|--|--|--------------------------|-------------------|---|
| | | | Fourth Digit: "0" - Standard "5" - Cylinder Dogging (Not with suffix "F") | Mechanical Feature "F" - Fire Exit Device "TD" - Tornado Device Electrical Feature "-B" - Bar Monitor or Signaling "-O" - Outside Trim Monitor or Signaling | Size: DOW = Door Opening Width  "32" - 24" to 32" DOW "36" - 30" to 36" DOW "42" - 37" to 42" DOW "48" - 36" to 48" DOW Door Height: -8 = 8' (2.44m) | Trim Design (Lever or knob only) | Trim Model Number | See Page 2 | Other Information: Door Hand - RHR or LHR Door Thickness - Over 1-3/4" (45mm) Fastener Options - TORX® Security Screws Specialty Cylinders & Components |

It is recommended that exit devices and trim for the same opening be ordered together. Standard product is for 1-3/4" (44mm) reinforced metal doors. Accessories detached from the device and trim should be specified separately. Materials by others are required to be fit for the purpose as detailed in this catalog and the product installation literature.



online literature and templates

For the latest information on Yale Locks & Hardware products, visit our website at: www.yalelocks.com

Click on the "Product Information" button to find:

- Catalogs
- Parts manuals
- Templates
- Specifications
- Installation instructions

Yale® customers can click on the ebusiness symbol  on the website to register for an ebusiness account to:

- Check the status of orders
 - Check availability of QuickShip items
 - Track your order and confirm delivery
 - Receive email notification of template changes
- And More...

Or contact us at:

U.S.A.

Yale Locks & Hardware

Address: 225 Episcopal Road, Berlin, CT 06037-4004
Tel: 1-800-438-1951 • Fax: 1-800-338-0965 • www.yalelocks.com

Canada:

ASSA ABLOY Door Security Solutions Canada

Address: 160 Four Valley Drive, Vaughan, Ontario L4K 4T9
Tel: 1-800-461-3007 • Fax: 1-800-461-8989 • www.assaabloy.ca

International:

ASSA ABLOY Americas International

Tel: 1-905-821-7775 • Fax: 1-905-821-1429 • www.assaabloyai.com

Yale Locks & Hardware is a division of Yale Security Inc., an ASSA ABLOY Group company.

Yale®, Reflections®, SecureX®, Lumi-Lite®, SquareBolt® and MicroShield® are registered trademarks of Yale Security Inc., an ASSA ABLOY Group company. Free Wheeling and Design™ are trademarks of Yale Security Inc., an ASSA ABLOY Group company. KeyMark® is a registered trademark of Medeco Security Locks, Inc., an ASSA ABLOY Group company. Other products' brand names may be trademarks or registered trademarks of their respective owners and are mentioned for reference purposes only. These materials are protected under U.S. copyright laws. All contents current at time of publication. Yale Security, Inc. reserves the right to change availability of any item in this catalog, its design, construction, and/or its materials. Copyright © 2010, 2013, Yale Security Inc., an ASSA ABLOY Group company. All rights reserved. Reproduction in whole or in part without the express written permission of Yale Security Inc., an ASSA ABLOY Group company is prohibited.

YALE, with its unique global reach and range of products, is the world's favorite lock.

ASSA ABLOY is the global leader in door opening solutions, dedicated to satisfying end-user needs for security, safety and convenience.

42734-9/13RE