



Competitor Indicator Kits

Best® and Schlage® Mortise Locks



ACCENTRA

ASSA ABLOY

ASSA ABLOY is transitioning the Yale Commercial brand to ACCENTRA. This affects only the brand name; the products and product numbers will remain unchanged. Prior to May 20, 2024, products may be shipped either as Yale Commercial brand or ACCENTRA brand. Products shipping after May 20, 2024, will be branded ACCENTRA.

Table of Contents



Contents

Features	3
Finishes	4
Indicator Option Codes	5
Best® Mortise Locks	6
Schlage® Mortise Locks	7
How to Order	8
Parts	9

Competitor indicator kits are approved by UL as an accessory item on doors using Schlage® L9000 or Best® 45H/34H/35H mortise locks. Kits should be ordered only for the specific functions as listed by Yale Commercial and are surface applied as an accessory to existing locksets.

Competitor Indicator Kits



Indicator Retrofit Kits

Indicators can be used in a variety of applications and are most commonly used to identify occupancy or display the locked/unlocked status of a room.

Upgrade existing Best® or Schlage® mortise locks with a retrofit indicator kit from Yale. These kits offer a seamless upgrade to existing sectional mortise locks to add security and privacy from Yale.

Features

- Can be mounted on the inside, outside or both sides of the door
- Available for a variety of Best® and Schlage® functions
- Viewing window 25% larger than competition
- Patented curved design for viewing at multiple angles
- Window located prominently above the cylinder
- Highly reflective viewing window for increased safety
- Multiple color, text, graphic and language combinations available
- Covers existing Best® or Schlage® sectional trim indicator preps
- Two-year warranty



Cylinder*



Cointurn



Thumbturn



Blank/No Input

*Cylinder not included.

Typical Applications









- Classroom doors
- Privacy rooms
- Nursing/new mother rooms
- Patient rooms
- Restrooms
- Meeting rooms

Certifications

- UL/cUL Classified for use on 3 hr doors using Schlage® L9000 or Best® 45H/34H/35H mortise locks

Finishes

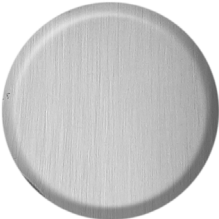

ANSI/BHMA Code Finish Description			
605 Bright Brass, Clear Coated	606 Satin Brass, Clear Coated	612 Satin Bronze, Clear Coated	613E Dark Oxidized Satin Bronze - equivalent
			
618 Bright Nickel Plated, Clear Coated	619² Satin Nickel Plated, Clear Coated	625 Bright Chrome Plated	626² Satin Chrome Plated
			
629¹ Bright Stainless Steel	630^{1,2} Satin Stainless Steel		
			

Note: All finishes will be provided per Yale color standards. Yale does not guarantee finish will match to Best® or Schlage® finish.

- Indicator escutcheon nickel plated to match stainless steel.
- Finish available with MicroShield® antimicrobial coating, additional finishes by special application. Consult factory for availability.

MicroShield coating may vary finish color from architectural standards. MicroShield is not intended as a substitute for traditional infection control programs such as hand hygiene or use of disinfectants. Coated products must still be cleaned to ensure the surfaces will be free of destructive microbes. Yale makes no representations or warranties, express or implied, as to the efficacy of MicroShield.

Indicator Option Codes



Mortise indicator option codes are designed to convey wording and color in one simple code.



V10



V40



V20



V50



V30



V60



V10F



V20F

Option Code	Wording	Color
V10	Unlocked/Locked	Green/Red
V10F	Ouvert/Fermé	Green/Red
V20	Vacant/Occupied	Green/Red
V20F	Libre/Occupée	Green/Red
V30	Icons Only	Green/Red
V40	Unlocked/Locked	White/Red
V50	Vacant/Occupied	White/Red
V60	Icons Only	White/Red

Best® Mortise Locks



Sectional trim indicator kits are available to retrofit to Best® 45H, 34H or 35H series mortise locks. Kits can be ordered to be used on the inside, outside or both sides of the door. Each kit includes a single side indicator plate with mechanism, screw pack, plastic template and instructions.

- Kits available for use on sectional trim installations only
- Can only be used with H or R roses. Roses greater than 3-1/4" in diameter cannot be used.
- Thumbturn design will be the standard Yale® thumbturn
- L and LT privacy functions will use a coin turn for emergency override

The following chart details the functions that can be accommodated.

Best® Function	Illustration	Description	Outside	Inside
L		Privacy F19	BE193 	
LT		Privacy		
AB		Office F20		BE194
AT		Office F04		
RD		Classroom DL F29		
TA		Dormitory F12		
TD		Dormitory		
IND		Intruder F33		BE190*
INL		Intruder F32		

*Cylinder not included. Accepts a standard 1-1/8" mortise cylinder.

Function numbers, illustrations and descriptions above are from the Best® 40H series catalog. Refer to that catalog for more information and function details.

Schlage® Mortise Locks



Sectional trim indicator kits are available to retrofit to Schlage® L series mortise locks. Kits can be ordered to be used on the inside, outside or both sides of the door. Each kit includes a single side indicator plate with mechanism, screw pack, plastic template and instructions.

- Kits available for use on sectional trim installations only
- Can be used with A, B, C, AVA or MER roses. Roses greater than 3-1/4" in diameter cannot be used.
- Thumbturn design will be the standard Yale® thumbturn
- L/LV9040 and L/LV9044 privacy functions will use a coin turn for emergency override

The following chart details the functions that can be accommodated.

Schlage® Function	Illustration	Description	Outside	Inside
L/LV9040		Privacy F22	SC193 	SC194
L/LV9044		Privacy		
L/LV9050		Office F04	SC190* 	
L/LV9456		Corridor F13		
L9473		Dormitory F21		
L/LV9060		Apartment Entrance Lock F09		
L/LV9071		Classroom Security F32		
L/LV9077		Classroom Security Holdback		
L/LV9457		Classroom Security F33		
L/LV9458		Classroom Security F34		
L9466		Store/utility Room Lock with Deadbolt F14		
L/LV9070		Classroom Lock F05		SC197

*Cylinder not included. Accepts a standard 1-1/8" mortise cylinder.

Function numbers, illustrations and descriptions above are from the Schlage® L series catalog. Refer to that catalog for more information and function details.

How to Order



To order, specify by model number. Door thickness and indicator option code must be specified with each kit.

Competitor indicator kits are handed and easily field reversible. All units are shipped from the factory with a default handing. Handing **must** be field verified and adjusted as needed per product installation instructions.

Best®

Model Number	Door Thickness	Finish	Option Code
BE190	1-3/4"	626	V10

Schlage®

Model Number	Door Thickness	Finish	Option Code
SC190	1-3/4"	626	V10

Note: Indicators for both sides of the door require two kits.

Parts



Replacement parts are available as follows:

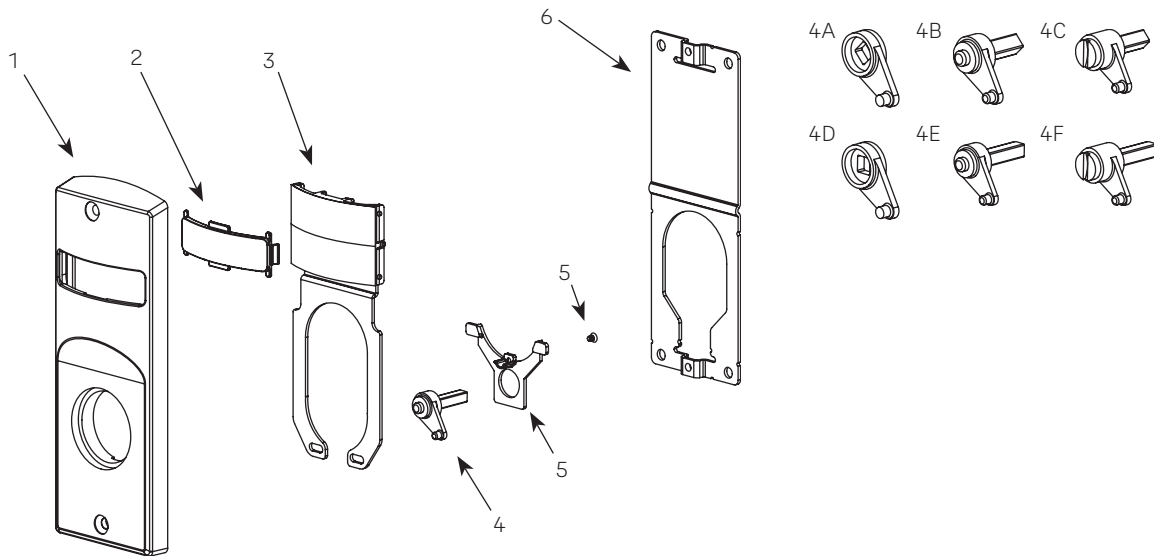

Item #	Description	Part Number
1	Best® Sectional Escutcheon - Cylinder	50-8800-2304 x Finish
	Schlage® Sectional Escutcheon - Cylinder	50-8800-2303 x Finish
	Best Sectional Escutcheon - Thumbturn (includes thumbturn)	50-8800-0390* x Finish
	Schlage Sectional Escutcheon - Thumbturn (includes thumbturn)	50-8800-0389* x Finish
	Best or Schlage Sectional Escutcheon - Cointurn (cointurn not included)	50-8800-2301 x Finish
	Best or Schlage Sectional Escutcheon - No Input / Blank	50-8800-2302 x Finish
2	Indicator Window	856F049
3	Display Assembly - Green Unlocked / Red Locked	858F241
	Display Assembly - Green Vacant / Red Occupied	858F251
	Display Assembly - Green Unlocked Icon / Red Locked Icon	858F261
	Display Assembly - White Unlocked / Red Locked	858F271
	Display Assembly - White Vacant / Red Occupied	858F281
	Display Assembly - White Unlocked Icon / Red Locked Icon	858F291
	Display Assembly - Green Ouvert / Red Fermé	865F241
	Display Assembly - Green Libre / Red Occupée	865F251
4A	Best Spindle Cam - Thumbturn	855F619
4B	Best Spindle Cam - Cylinder / No Input / Blank	855F707*
4C	Best Spindle Cam - Cointurn (includes cointurn)	855F747* x Finish
4D	Schlage Spindle Cam - Thumbturn	50-8800-9322
4E	Schlage Spindle Cam - Cylinder / No Input / Blank	50-8800-7314*
4F	Schlage Spindle Cam - Cointurn (includes cointurn)	50-8800-7318* x Finish
5	Retaining Pad and Screw Kit	50-8800-0391
7	Mounting Plate	855F658
Not Shown	Screw Pack	858F497 x Finish
Not Shown	Template Kit	50-8800-9327

*These parts are for 1-3/4" standard thickness doors. For other thicknesses, please contact factory.



Trusted every day

Phone

1-855-557-5078

Customer Service Email

customerservice.yale@assaabloy.com

Technical Product Support Email

techsupport.yale@assaabloy.com

Order Entry Email

orders.yaleus@assaabloy.com

Fax

1-800-338-0965

Website

www.yalecommercial.com

Contact Us

U.S.A.

Yale Locks & Hardware

Address: 225 Episcopal Road

Berlin, CT 06037-4004

Tel: 1-800-438-1951

Fax: 1-800-338-0965

yalecommercial.com

Canada:

ASSA ABLOY Door Security Solutions Canada

Address: 160 Four Valley Drive

Vaughan, Ontario L4K 4T9

Tel: 1-800-461-3007

Fax: 1-800-461-8989

assaabloydss.ca

International:

ASSA ABLOY Americas International

Tel: 1-905-821-7775

Fax: 1-905-821-1429

assaabloyai.com

MicroShield®

ASSA ABLOY Group companies offer MicroShield®, an anti-microbial coating for door hardware. MicroShield uses proven silver ion-based technology from Agion®, a leading provider of antimicrobial solutions, to stem the spread of bacteria and other microbes.

MicroShield® is a registered trademark of ASSA ABLOY Access and Egress Hardware Group, Inc.



The Agion antimicrobial is not intended as a substitute for good hygiene. Coated products must still be cleaned to ensure the surfaces will be free of destructive microbes. ASSA ABLOY makes no representations or warranties, express or implied, as to the efficacy of the Agion antimicrobial. A copy of the Agion warranty is available upon request. Agion is a registered trademark of Agion Technologies, Inc., Wakefield, MA, USA.

THE YALE BRAND, with its unparalleled global reach and range of products, reassures more people in more countries than any other consumer locking solution.

THE ASSA ABLOY GROUP is the world's leading manufacturer and supplier of locking solutions, dedicated to satisfying end-user needs for security, safety and convenience.

Yale Commercial is a business associated with ASSA ABLOY Access and Egress Hardware Group, Inc., an ASSA ABLOY Group company. Copyright © 2021-2022, ASSA ABLOY Access and Egress Hardware Group, Inc. All rights reserved. Reproduction in whole or in part without the express written permission of ASSA ABLOY Access and Egress Hardware Group, Inc. is prohibited. Patent pending and/or patent www.assaabloydss.com/patents.