

ACCENTRA

ASSA ABLOY

Experience a safer
and more open world

ASSA ABLOY ACCENTRA™

Multi-Family Housing Distributor Catalog



IMPORTANT: A Certified Integrator is required to supply ASSA ABLOY , components, and configure devices into the system. To find a Certified Buy finder on accentra-assaabloy.com or inquire with your ASSA ABL

ACCENTRA
ASSA ABLOY

ASSA ABLOY is transitioning the Yale Commercial brand to ACCENTRA. This affects only the brand name; the products and product numbers will remain unchanged. Prior to May 20, 2024, products may be shipped either as Yale Commercial brand or ACCENTRA brand. Products shipping after May 20, 2024, will be branded ACCENTRA.

CONTENTS

Solution Overview

System Overview	3
-----------------------	---

nexTouch® Cylindrical Lock

Technical Specifications	4
Features	5
How to Order	6
Dimensions and Lever Designs	7
Functions and Finishes	8
Cylinders	9-10
Latchbolts and Strikes	11
Options and Accessories	12
Certifications and Listings	13

nexTouch® Sectional Mortise Lock

Technical Specifications	14
Features	15
How to Order	16
Trim Designs	17
Reflections® Decorative Trim	18
Functions and Finishes	19
Cylinders	20-22
Cylinder Collars	23
Strikes	24
Dimensions	25
Options & Accessories	26
Certifications & Listings	27

nexTouch® Keypad Exit Trim

Technical Specifications	28
Features	29
How to Order	30
Trim Designs	31
Finishes	32
Functions	33
Cylinders	34-36
Cylinder Collars	37
Dimensions	38
Compatible Exit Devices	39-41
Options & Accessories	42
Certifications & Listings	43

nexTouch® Interconnected Lock

Technical Specifications	44
Features	45
How to Order	46
Lever Designs, Finishes, and Functions	47
Dimensions and Cylinders	48
Latchbolts	49
Strikes	50





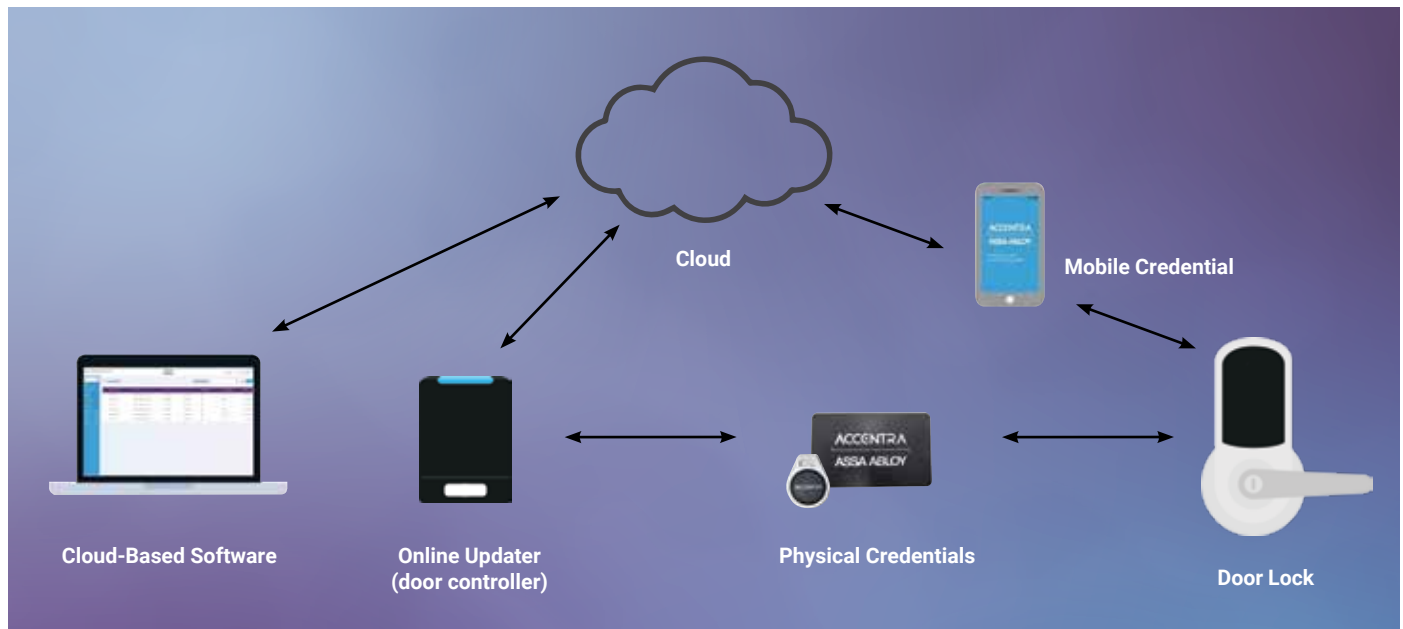

nexTouch® Digital Deadbolt

Technical Specifications	52
Features	53
How to Order and Finishes	54
Dimensions	55
Cylinders, Thin Door Kit	56
Strikes	57
Latchbolts	58
Suiting Your Hardware	59

ACCESS CONTROL MADE EASY

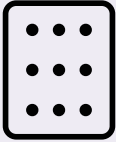
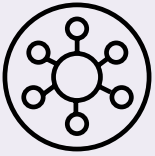
The ASSA ABLOY ACCENTRA™ Multi-Family Solution combines smart locks with intuitive cloud-based software for easy and convenient access management of multi-family properties in a single system. Access updates can be instantly applied using the mobile access app or an online updater for physical credentials. Avoid the hassles and costs that come with wiring every door or managing access with keys while making your property a more secure, convenient, and attractive place to live.

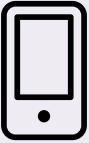

<p>Cloud-based access management at every opening</p> 	<p>Manage access remotely for one or multiple sites</p> 	<p>Remotely unlock online doors and grant emergency access to offline doors with one-time PIN codes</p> 	<p>One manufacturer, one system, one credential</p> 
<p>Intuitive, easy-to-use software</p> 	<p>Eliminates costly key management</p> 	<p>Highly encrypted and secure</p> 	<p>The ASSA ABLOY Accentra Access app delivers instant updates to a mobile user's access rights</p> 

**CONTROL ACCESS TO COMMON
AREAS AND EXTERIOR DOORS**

nexTouch®
Cylindrical Lock



Technical Specifications

Door Specifications	Fits into the standard ANSI/BHMA A156.115 cylindrical lock with lever door prep with one additional 3/4" hole and 7 screws including latchbolt and strike
Backset	2-3/4" (70mm) standard backset
Door Thickness	1-3/4" (44mm) door thickness standard; thin door kit required for 1-3/8" thick doors
Handing	Non-handed
Latchbolt	1/2" (13mm) throw deadlocking latchbolt supplied standard
Strike	ANSI strike 4-7/8" x 1-1/4" x 1-1/4" (124 mm x 32 mm x 32 mm) lip to center supplied standard
Cylinder	Accepts ASSA ABLOY ACCENTRA™ fixed core component cylinders; also available to accept small format interchangeable core (SFIC)
Keying	Capable of accepting ASSA ABLOY ACCENTRA™ 6-pin standard, small and large format interchangeable core, security and protected keyway cylinders with master keying capabilities
Packing	Each box includes a paper door marker, combination wood and machine screws and easy-to-follow installation and programming instructions; cylinder functions supplied with two keys
ANSI/BHMA	Certified ANSI/BHMA A156.2, Series 4000 Grade 1
UL/cUL	Functions are UL - cUL Fire Listed for use on fire doors having a rating up to and including 3-hours
Warranty	3-year electronic and mechanical, 1-year finish
Environmental Specifications	Operating temperature: -40°F to +140°F (-40°C to +60°C) at 95% relative humidity when used with an external power supply
Power Source	Four AA alkaline batteries (included) with optional hardwire input for 9VDC external power; 9V battery power backup
Credentials	Seos™ cards, fobs, and ASSA ABLOY ACCENTRA™ mobile credentials
Interface	Capacitive touchscreen or pushbutton
Firmware Upgradeability	Locks support on-premise wireless configuration and firmware upgrades

ACCENTRA

ASSA ABLOY



Capacitive Touchscreen

Touchscreen shown when activated

Lockout Indicator

Voice Assisted Programming

Low Battery Indicator

Weather Resistant – Gasketed seal allows for outdoor installation of exterior escutcheon



9V Battery Power Backup

Solid Metal Escutcheon - Provides quality and durability

Optional Cylinder/Key Override (Key free also available)



A push button model is also available with durable acrylic, back lit buttons

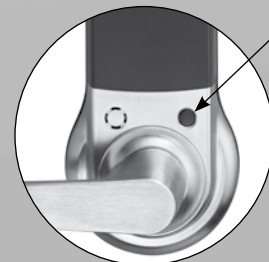

Privacy Button – Prevents unwanted access from the outside at the touch of a button

HOW TO ORDER

Quantity	Lever Design	Series	Function	^Technology	Finish	Advanced Functions	Door Thickness	Cylinder	Latch	Strike
#	AU – Augusta	NTB – nexTouch®	613 - Pushbutton Keypad - Key Override	ACC – Data-on-Credential	605 – Bright brass, clear coated	DPS***	1-3/4** 1-3/8"	1803-53L – 6-pin cylinder standard, see pages 18-19 for additional options**	694 latchbolt standard, see page 20 for additional options	497 ANSI strike standard, see page 20 for additional options
	PB – Pacific Beach		623 - Capacitive Touchscreen - Key Override		613E – Dark oxidized bronze - equivalent					
	MO – Monroe		633 - Pushbutton Keypad - No Key Override		626 – Satin chrome plated					
	TB									
	UB		643 - Capacitive Touchscreen - No Key Override		BSP - Black suede powder coat					

*1-3/4" door thickness is standard. Doors under 1-3/4" in thickness require a thin door kit. If you specify 1-3/8" door thickness, a thin door kit is provided automatically.

**When ordering SFIC and LFIC cylinders, please use appropriate prefix before lever selection. See page 17 for more information.

***Use DPS option code for Advanced Functions. An auxiliary Door Position Sensor (DPS) must be installed with the lock to enable both Escape Return and Privacy functions. If DPS is not included in the parts string, the Door Position Sensor will not be supplied with the lock.

Note: that selecting DPS option code will incur an upcharge. See current pricelist.

Build Your Order String

Quantity	Lever Design	Series	Function	^Technology	Finish	Advanced Functions	Door Thickness	Cylinder	Latch	Strike
Example:	AU	NTB	613	ACC	626		1-3/4"	1803-53L	694	497
Example:	PB	NTB	623	ACC	626	DPS	1-3/4"	1803-53L	694	497

Packing

Each box has a paper door marker, combination wood and machine screws, four AA alkaline batteries, Allen wrench, lever removal tool and easy-to-follow installation and programming instructions. Cylinder functions supplied with two keys. When ordered with ACC functionality, the NTX600-ACC-Key ASSA ABLOY ACCENTRA™ module is included in the box.

^nexTouch Accentra lock part numbers NTB613, NTB623, NTB633, & NTB643 can be used as a stand alone, keypad only function by removing the Accentra radio module from the lock. **These part numbers can NOT be upgraded for use with a Z-Wave compatible system.**

DIMENSIONS AND LEVER DESIGNS

Dimensions

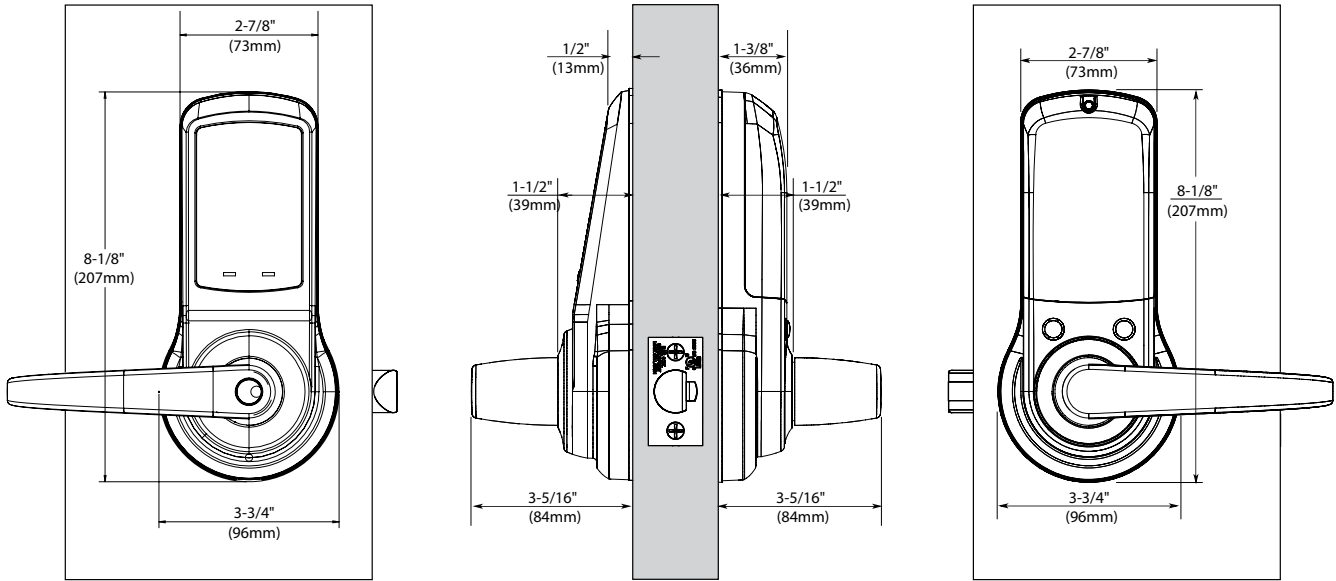

Dimensions given in inches (mm).

Lever Designs

<p>AUGUSTA AU Lever: Cast Zinc</p> 	<p>MONROE MO Lever: Cast Zinc</p> 	<p>PACIFIC BEACH PB Lever: Cast Zinc</p> 	<p>TB Lever: Cast Zinc</p> 	<p>UB Lever: Cast Zinc</p> 
				

 All levers available with small and large format interchangeable core. See pages 18-19 for details.

FUNCTIONS AND FINISHES

Functions

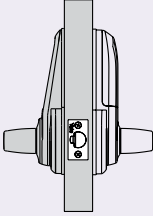
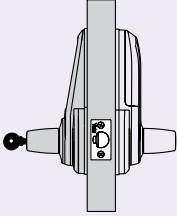
NTB633 Pushbutton NTB643 Touchscreen	NTB613 Pushbutton NTB623 Touchscreen
<p>Without Cylinder Override</p> <ul style="list-style-type: none"> • For doors that do not require mechanical key override. • Latchbolt retracted by lever outside with presentation of valid credential, with valid PIN code, or by operating lever inside. • Inside lever always active. • Deadlocking latchbolt. <div style="text-align: center;">  </div> <div style="display: flex; justify-content: space-around; width: 100%;"> Outside Inside </div>	<p>With Cylinder Override</p> <ul style="list-style-type: none"> • For doors that require mechanical key override. • Latchbolt retracted by lever outside with presentation of valid credential, with valid PIN code, or by operating lever inside. • Inside lever always active. • Deadlocking latchbolt. <div style="text-align: center;">  </div> <div style="display: flex; justify-content: space-around; width: 100%;"> Outside Inside </div>

Lever handles are Free Wheeling in locked position. Shaded area denotes Free Wheeling lever.

Finishes

ANSI/BHMA Code Finish Description			
605 Bright Brass, Clear Coated	613E Dark Oxidized Satin Bronze - equivalent	626 Satin Chrome Plated	BSP Black Suede Powder Coat
			

CYLINDERS

Cylinder Options

The following selection guide indicates the correct cylinder for each locking segment.

Lockset Series nexTouch®	Types of Cylinder Mechanisms							
		Conventional		Protected Keyway		Security		
Cylinder Types	Fixed Core	6-pin	7-pin	6-pin	7-pin	6-pin	7-pin	
	Key-In-Lever	1803-53L*	N/A	K403-53L*	N/A	5803-53L*	N/A	
	Interchangeable Core							
	LFIC	1210	N/A	K800	N/A	5210	N/A	
SFIC	A600	A600	K600	K600	N/A	N/A		

Refer to ASSA ABLOY ACCENTRA™ KeyMark® and/or Cylinders and Keys Catalog sections for all details and how-to-order examples.

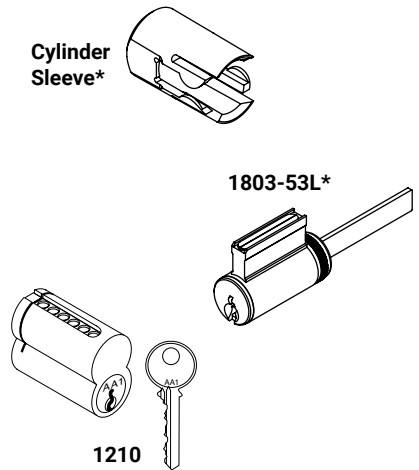

Other Manufacturer Keyway Cylinders

Illustration	Description	Model Number	Number of Pins
	Best® Keyway Cylinder. Available keyed random, master keyed or uncombined. Specify keyway A, B, C, D, E, F, G, H, J, K, L or M.	A600	6 or 7
	Schlage® "C" Keyway. Available 0-bitted or keyed random.	2803-53L*	6
	Corbin Russwin "L4", Corbin "60", Russwin "D1", Sargent® "LA" or Schlage® "E" Keyway. Specify keyway. Available keyed random.	3803-53L*	6
	Arrow "AR"	100CV1*	6

***All cylinders require a cylinder sleeve (P/N 14-1803-9001-000) to fit nexTouch® locksets manufactured prior to January 2022.**

CYLINDERS

Levers Accepting SFIC And Other Manufacturers' Large Format Interchangeable Cores



Description	Lever Prefix	Number of Pins
SFIC (Accepts all Small Format Interchangeable Cores)	B (i.e. B-AU, B-MO, B-PB, B-TB, B-UB)	6 or 7
Corbin Russwin (LFIC)*	R (i.e. R-AU)	6
Medeco®, ASSA® (LFIC)	M (i.e. M-AU)**	6
Sargent (LFIC)	SG (i.e. SG-AU, SG-PB)	6
Schlage® (LFIC)	SI (i.e. SI-AU, SI-PB)	6

*Corbin-Russwin LFIC only available with AU lever, 6-pin only
 **Medeco®, ASSA® option available only with AU lever. (Note: For Medeco 32 series cores.)
 LFIC = Large Format Interchangeable Core
 SFIC = Small Format Interchangeable Core

108 Schlage® Cylinder Adapter Kit

Kit used to modify Schlage® cylinder to fit nexTouch®.

P/N 14-5407-9101-999 - 108S

Kit includes tailpiece and sleeve. To order the 108S adapter kit, use an "S" prefix (i.e., S-AU x NTB613).

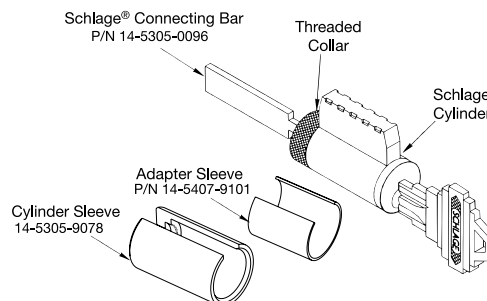

ASSA ABLOY ACCENTRA™ KeyMark®

For those applications requiring protected key control, ASSA ABLOY ACCENTRA™ KeyMark® cylinders guard against unauthorized key duplication. The ASSA ABLOY ACCENTRA KeyMark Security Leg® keyway feature increases resistance against picking and impressioning and can easily retrofit into existing systems. For further details and availability, refer to the separate ASSA ABLOY ACCENTRA KeyMark catalog.

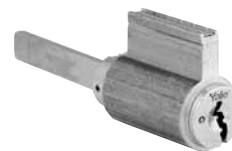

LATCHBOLTS AND STRIKES

Deadlocking Latchbolts

Model No. E694 supplied standard with all nexTouch® locksets. Model No. E694 latchbolt has a 2-1/4" x 1-1/8" front with a 2-3/4" backset and a 1/2" bolt throw. Optional latchbolts to special order.

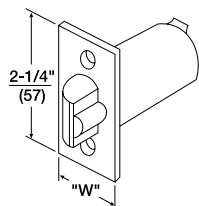

Model No.	Front	Backset	"W" Front Width	Throw	Latch Diameter
694 (standard)	Beveled	2-3/4" (70mm)	1-1/8" (29mm)	1/2" (13mm)	1" (25mm)
F694	Flat	2-3/4" (70mm)	1-1/8" (29mm)	1/2" (13mm)	1" (25mm)
480B	Beveled	2-3/4" (70mm)	1-1/8" (29mm)	3/4" (19mm)	1" (25mm)
F480B	Flat	2-3/4" (70mm)	1-1/8" (29mm)	3/4" (19mm)	1" (25mm)
380N*	Universal	2-3/8" (60mm)	1" (25mm)	1/2" (13mm)	7/8" (22mm)

When ordering latchbolts separately, specify Model No. x Finish (e.g., E694 x 626).
*Using 380N latch results in Grade 2 ANSI/BHMA performance of the lock.

Strikes

ASSA ABLOY ACCENTRA™ nexTouch® locksets are available with a variety of strike options. All strikes are located on the same vertical and horizontal center lines as the latchbolt. Some strikes are available in a variety of lip lengths to accommodate varying thickness of doors and frames. To determine the proper length of the lip, measure from the center line of the strike to the edge of the jamb and add 1/4" (6mm). All strikes are reversible.

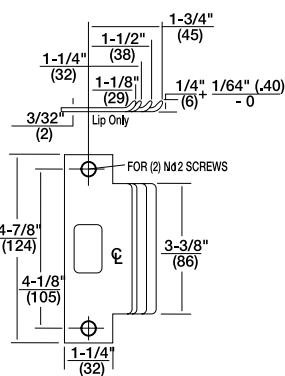

Model No. 497 ANSI Strike (Standard)

For door and frames with ANSI/BHMA A156.115 preparations. 1-1/4" supplied standard. 1-1/8", 1-1/2", and 1-3/4" lip lengths available by special order.

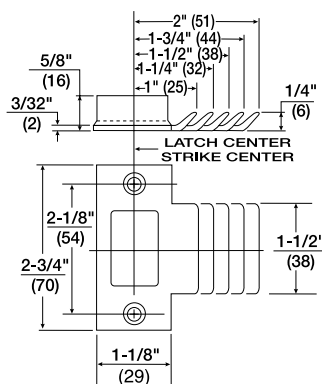

Model No. 371 T-Strike (Optional)

1-1/4" curved lip supplied standard. 1", 1-1/2", 1-3/4", and 2" curved lip lengths available by special order. Wrought strike box supplied.

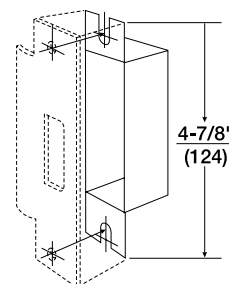

Model No. 202 Strike Box for ANSI Strike (Optional)

Specify 497 x 202

OPTIONS AND ACCESSORIES

Model/Part Number	Description
784	Optional remote 9VDC power supply with plug-in wall transformer (used for hardwiring up to two nexTouch® locks).
WH-28	Remote power and request to enter wire harness.
14-4761-0106-025	1-3/8" thin door kit. Includes inside and outside escutcheon spacers as well as a 2-3/8" latchbolt.
NTX600-ACC-KEY	ASSA ABLOY ACCENTRA™ module*
14-B600-0111-999	3-Wire Door Position Sensor

*This technology module can be used to upgrade stand-alone nexTouch® locks for use in the ASSA ABLOY ACCENTRA™ multi-family solution by enabling data-on-credential technology. This is included when ordering nexTouch® locks with ACC in the order string.



Hardwire Option Diagram

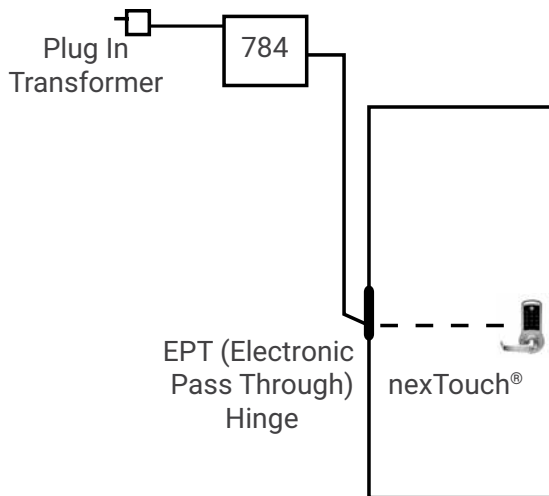

CERTIFICATIONS AND LISTINGS

ADA



The nexTouch® Series lever design meets accessibility guidelines of the Americans with Disabilities Act and the requirements of the Uniform Federal Accessibility Standards and ICC/ANSI A117.1 Accessible and Usable Buildings and Facilities, all requiring ease of accessibility.

ANSI/BHMA



nexTouch® cylindrical certified ANSI/BHMA A156.2, Series 4000 Grade 1.

Fire Listings



Functions are UL/cUL Fire Listed for use on fire doors having a rating up to and including 3 hours.

Note: Any retrofit or other field modification to a fire rated opening can potentially impact the fire rating of the opening, and ASSA ABLOY ACCENTRA™ Locks & Hardware makes no representations or warranties concerning what such impact may be in any specific situation. When retrofitting any portion of an existing fire rated opening, or specifying and installing a new fire-rated opening, please consult with a code specialist or local code official (Authority Having Jurisdiction) to ensure compliance with all applicable codes and ratings.

FCC

Complies with limits for a Class B digital device, pursuant to part 15 of the FCC Rules.

ISO 14001

Designed and manufactured under a certified ISO 14001 quality system.

Sustainability

EPD and GreenCircle certification.

Warranty

nexTouch® has a three-year limited warranty on the mechanical and electrical components, and a one-year limited warranty on the finish.

Windstorm

Certified (refer to local codes).



nexTouch® Sectional
Mortise Lock



Technical Specifications

Door Specifications	Fits into the standard mortise door prep
Backset	2-3/4" (70mm) standard backset
Door Thickness	1-3/4" (44mm) door thickness standard; please specify for other door thicknesses
Handing	Field reversible
Latchbolt	3/4" spring latchbolt standard, 1" throw deadlocking latchbolt optional
Strike	Curved lip strike with 1-1/4" (32 mm) lip length standard
Cylinder	Accepts conventional, interchangeable core, security and high security cylinders, and other manufacturers' keyway cylinders
ANSI/BHMA	Certified ANSI/BHMA Grade 1
UL/cUL	Functions are UL - cUL Fire Listed for use on fire doors having a rating up to and including 3-hours
Warranty	3-year electronic and mechanical, 1-year finish
Environmental Specifications	Operating temperature: -40°F to +140°F (-40°C to +60°C) at 95% relative humidity when used with an external power supply
Power Source	Four AA alkaline batteries (included) with optional hardwire input f or 9VDC external power; 9V battery power backup on keypad
Credentials	Seos™ cards, fobs, and ASSA ABLOY ACCENTRA™ mobile credentials
Interface	Capacitive touchscreen or pushbutton keypad
Firmware Upgradeability	Locks support on-premise wireless configuration and firmware upgrades

Touchscreen shown when activated



Weather Resistant Seal



Lockout Mode



Low Battery Indication

9V Battery Power Backup



A push button model is also available with durable acrylic, back lit buttons



Optional Security Deadbolt

Reflections® decorative lever options available



Built-in Door Position Sensor/Deadlocking Function

A push button model is also available with durable acrylic, back lit buttons



HOW TO ORDER

Quantity	Lever Design	Series	Function	^Technology	Finish	Hand	Door Thickness	Cylinder	Strike
	AUR – Augusta	NTM nexTouch® mortise	613 - Pushbutton Keypad - Key Override - No Deadbolt	ACC – Data-on-Credential	605 Bright brass, clear coated	RH LH	1-3/4" standard, up to 2-1/4" door thickness available	2153 cylinder standard, see pages 29-31 for additional options	2815 curved lip strike standard, see page 33 for additional options
	MOR – Monroe		618 - Pushbutton Keypad - Key Override - w/ Deadbolt		613E Dark oxidized bronze - equivalent				
	PBR – Pacific Beach		623 - Capacitive Touchscreen - Key Override - No Deadbolt		626 Satin chrome plated				
	ARR – Arcadia		628 - Capacitive Touchscreen - Key Override - w/ Deadbolt		BSP Black suede powder coat				
	CRR – Carmel		633 - Pushbutton Keypad - No Key Override - No Deadbolt						
	JNR – Jefferson		638 - Pushbutton Keypad - No Key Override - w/ Deadbolt						
	PNR – Pinehurst		643 - Capacitive Touchscreen - No Key Override - No Deadbolt						
	VIR – Virginia		648 - Capacitive Touchscreen - No Key Override - w/ Deadbolt						
	See page 18 for Reflections decorative lever options								

Build Your Order String

Quantity	Lever Design	Series	Function	^Technology	Finish	Hand	Door Thickness	Cylinder	Strike
Example:	AUR	NTM	623	ACC	626	RH	1-3/4	2153	2815

Packing

Each box has a paper door marker, combination wood and machine screws, four AA alkaline batteries, Allen wrench, lever removal tool, and easy-to-follow installation and programming instructions. Cylinder functions supplied with two keys. When ordered with ACC functionality, the NTX600-ACC-Key ASSA ABLOY ACCENTRA™ Accentra module is included in the box.

^nexTouch Accentra lock part numbers NTM613, NTM618, NTM623, NTM628, NTM633, NTM638, NTM643, & NTM648 can be used as a stand alone, keypad only function by removing the Accentra radio module from the lock. **These part numbers can NOT be upgraded for use with a Z-Wave compatible system.**

TRIM DESIGNS

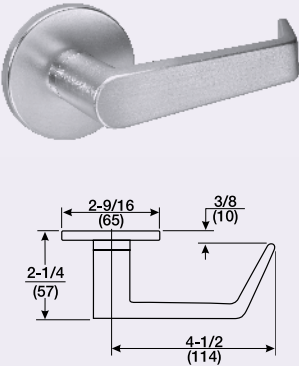
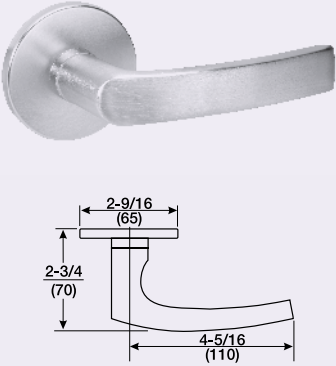
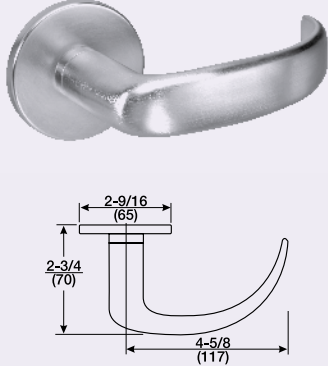
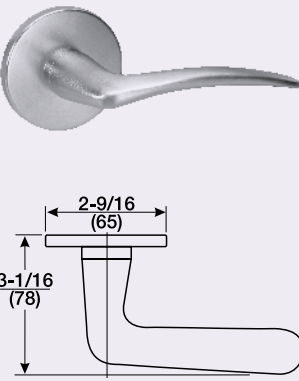
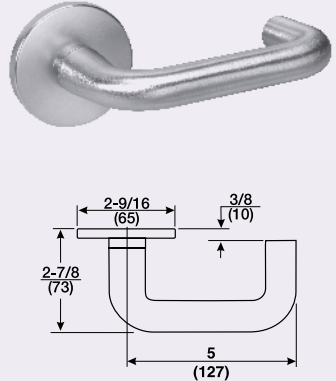
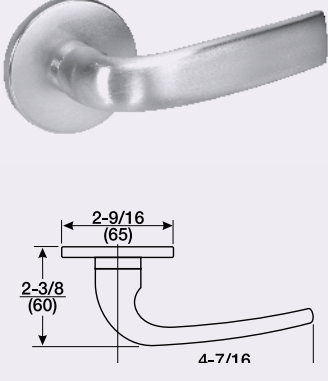
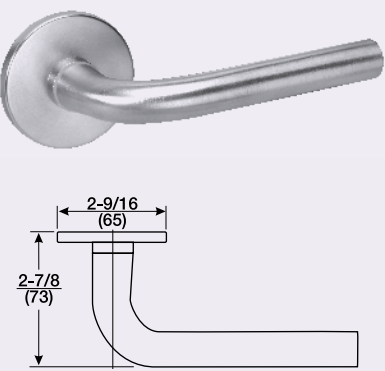
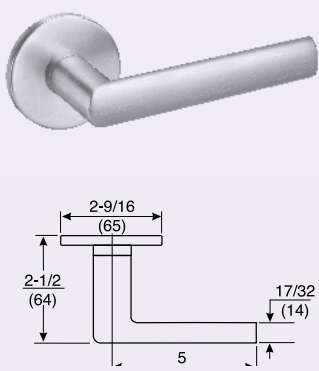
<p>AUGUSTA AUR AU Lever Handle: Cast</p>	<p>MONROE MOR MO Lever Handle: Cast</p>	<p>PACIFIC BEACH PBR PB Lever Handle: Cast</p>
		
<p>ARCADIA ARR AR Lever Handle: Cast</p>	<p>CARMEL CRR CR Lever Handle: Cast</p>	<p>JEFFERSON JNR JN Lever Handle: Cast</p>
		
<p>PINEHURST PNR PN Lever Handle: Cast</p>	<p>VIRGINIA VIR VI Lever Handle: Cast</p>	
		

REFLECTIONS® DECORATIVE TRIM

ASSA ABLOY ACCENTRA™ nexTouch® sectional mortise locks are available with Reflections lever trim, a comprehensive line of highly stylized lever handles. Reflections lever handles are made from solid brass or stainless steel and can withstand years of abuse. Available in an array of finishes, these levers complement any wood grain or other door exterior. Each lever is hand-polished and specially designed for ergonomics and style.

Hudson	Spree	Seine	Thames	Victoria	Niagara
TB	RS	TE	TM	TT*	CH*
UB	RT	TG*	TN	TU*	DW
TC	RU	TI	TP	TV*	MA*
TD	RV	TJ*	TR	TW*	RA*
UC		TK*	TS	UW*	RB*
		TO*	TQ	TX*	RC*

Reflections® Roses

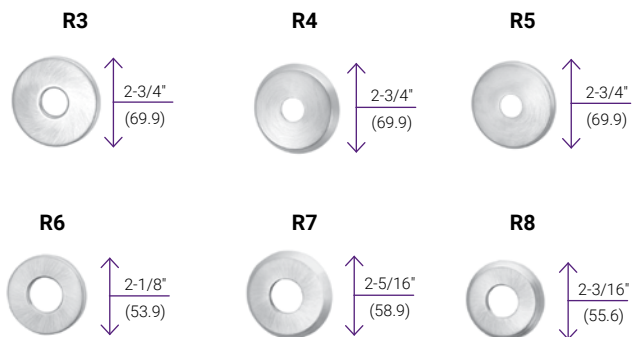

*Indicates levers that are handed.

FUNCTIONS AND FINISHES

Functions

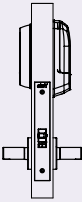
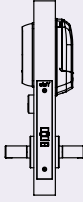
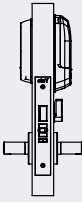
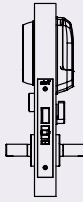
<p style="text-align: center;">NTM633 Pushbutton NTM643 Touchscreen</p> <p>No Deadbolt Without Cylinder Override</p> <ul style="list-style-type: none"> • For doors that do not require mechanical key override. • Latchbolt retracted by lever either side, except when outside lever is locked • Deadlocking latchbolt. <div style="text-align: center;">  <p>Outside Inside</p> </div>	<p style="text-align: center;">NTM613 Pushbutton NTM623 Touchscreen</p> <p>No Deadbolt With Cylinder Override</p> <ul style="list-style-type: none"> • For doors that require mechanical key override. • Latchbolt retracted by lever either side, except when outside lever is locked. • When outside lever is locked, latchbolt is operated by key outside. • Deadlocking latchbolt. <div style="text-align: center;">  <p>Outside Inside</p> </div>
<p style="text-align: center;">NTM638 Pushbutton NTM648 Touchscreen</p> <p>Deadbolt without cylinder override</p> <ul style="list-style-type: none"> • Latchbolt retracted by lever either side, except when outside lever is locked. • Deadbolt operated by thumbturn inside. • When deadbolt is projected, lever is automatically locked. • Anti-panic operation. Operating inside lever automatically retracts latch bolt and deadbolt with outside lever remaining locked. • Deadlocking latchbolt. <div style="text-align: center;">  <p>Outside Inside</p> </div>	<p style="text-align: center;">NTM618 Pushbutton NTM628 Touchscreen</p> <p>Deadbolt with cylinder override</p> <ul style="list-style-type: none"> • Latchbolt retracted by lever either side, except when outside lever is locked. • Deadbolt operated by key outside, thumbturn inside. • When outside lever is locked, latchbolt and deadbolt are operated by key outside. • When deadbolt is projected, lever is automatically locked. • Anti-panic operation. Operating inside lever automatically retracts latchbolt and deadbolt with outside lever remaining locked. • Deadlocking latchbolt. <div style="text-align: center;">  <p>Outside Inside</p> </div>

Finishes

ANSI/BHMA Code Finish Description			
605 Bright Brass, Clear Coated	613E Dark Oxidized Satin Bronze - equivalent	626 Satin Chrome Plated	BSP Black Suede Powder Coat
			

CYLINDERS

Conventional Cylinders

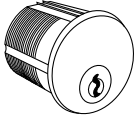
Illustration	Cylinder Model Number	Application		Length	
				6-Pin	7-Pin
	2153	Standard cylinder	2160	1-1/8" 1-1/4" 1-3/8" 1-1/2" 1-5/8" 1-3/4"	1-1/4" 1-3/8" 1-1/2" 1-5/8" 1-3/4"
	2153S	For inside operation of 8817-2 and 8834-2 functions only	2130		
	2123	Cylinder for longer lengths	2160	1-7/8" thru 3-1/2" in 1/8" increments*	
	2123S	For inside operation of 8817-2 and 8834-2 functions only for longer lengths	2130		
	2719	For hotel/motel locks 8820, 8827 and 8832	2160	1-3/8"	—

*Contact Technical Product Support for cylinder collar requirements when ordering these cylinders separately.

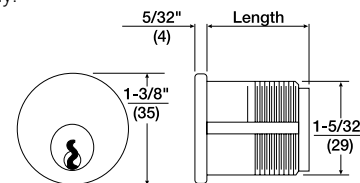

Interchangeable Core Mortise Cylinders

Cylinder Model Number	Application	Cam	Length	Pins	Housing Only Model Number	Core Only Model Number
2196	Standard Cylinder	2160	1-1/2", 1-3/4", 2"	6	2221	1210
2197	Standard Cylinder	2160	1-11/16", 2"	7	2213	1220

Note: When ordering interchangeable core cylinders or cores only, control keys are not furnished. If control keys are required they must be ordered separately.

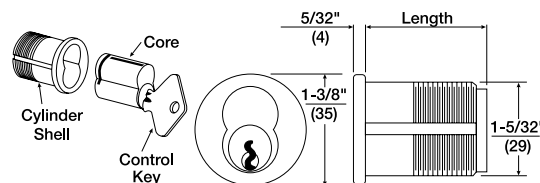

CYLINDERS

Security Cylinders

Security cylinders contain two independent locking mechanisms. The first is a traditional 6- or 7-pin tumbler mechanism with spool drivers for greatly increased picking resistance.

The second is an innovative 5-tumbler rotating disc mechanism with sidebar engagement. The rotating discs are spring loaded and block the bottom of the keyway.

Illustration

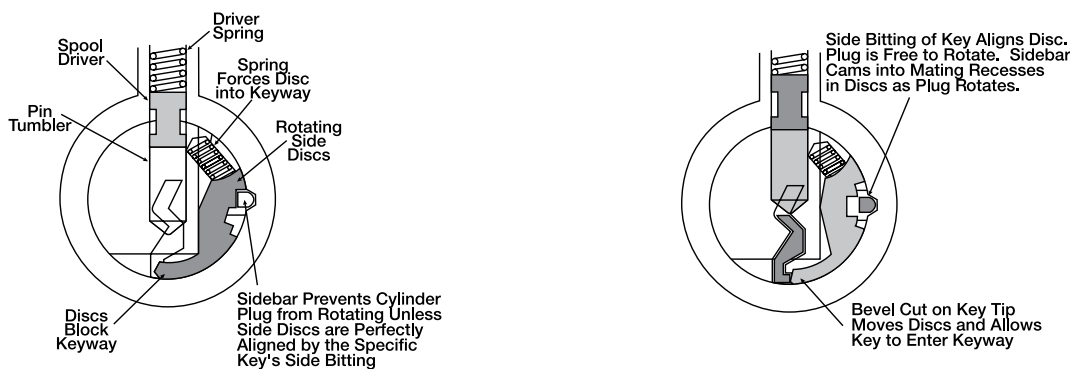

Security/High Security Mortise Cylinders

Model Number	Application	Cam	Length	
			6-pin	7-pin
5153/U5153	Standard Cylinder	2160	1-1/8" 1-1/4"	1-1/4"



Security Interchangeable Core Mortise Cylinders

Cylinder Model Number	Application	Cam	Length	Pins	Housing Only Model Number	Core Only Model Number
5196	Standard Cylinder	2160	1-1/2"	6	2221	5210
5197	Standard Cylinder	2160	1-11/16"	7	2213	5220

Note: When ordering interchangeable core cylinders or cores only, control keys are not furnished. If control keys are required they must be ordered separately.

CYLINDERS

Other Manufacturers' Keyway Cylinders/Cores

Illustration	Model Number	Type	Cam	Length	Pins	Housing Only Model Number	Core Only Model Number
	A620	Small Format IC Mortise, includes Best® Keyway Core. Available keyed random, master keyed or uncombined. Specify keyway A, B, C, D, E, F, G, H, J, K, L or M.	KC1	1-1/4"	6	K660	A600
				1-3/8" 1-3/4"	6 or 7		
	2553	Fixed Core Mortise Schlage® "C" Keyway Cylinder. Available 0-bitted or keyed random.	2160	1-1/8"	6	N/A	N/A

ASSA ABLOY ACCENTRA® KeyMark®

For those applications requiring protected key control, ASSA ABLOY ACCENTRA® KeyMark® cylinders guard against unauthorized key duplication. The ASSA ABLOY ACCENTRA KeyMark Security Leg® keyway feature increases resistance against picking and impressioning and can easily retrofit into existing systems. For further details and availability, refer to the separate ASSA ABLOY ACCENTRA KeyMark catalog.

Protected Keyway Mortise Cylinders

Model Number	Type	Cam	Length	Pins	Housing Only Model Number	Core Only Model Number
K100	Fixed Core Mortise	KC1	1-1/8", 1-1/4" 1-1/2", 1-3/4" 2"	6 or 7	N/A	N/A
K820	Large Format IC Mortise	KC1	1-1/2", 1-3/4" 2"	6	K860	K800
			1-11/16" 1-3/4", 2"	7		
K620	Small Format IC Mortise	KC1	1-1/4"	6	K660	K600
			1-3/8", 1-3/4"	6 or 7		
K630	Small Format IC Mortise-Tapered	KC1	1-1/4"	6	K670	K600
			1-3/8"	6 or 7		

CYLINDER COLLARS

Cylinder collars are supplied as standard where required with those locksets supplied with cylinders. Collar size and thickness are supplied to suit the length of the cylinder, the thickness of the door and the trim ordered. (If door thickness is not specified, collars will be furnished for 1-3/4" (44mm) door.)

Collar length required must be specified for cylinders and/or housings ordered separately.

1765 Recessed Cylinder Collar

"A" Dimension: Thicknesses available in 1/16" (2mm) increments from 1/16" (2mm) to 1-15/32" (37mm) as required.

Material: Brass, Stainless Steel

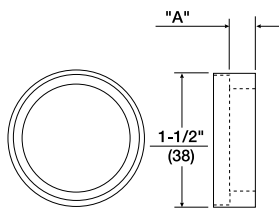

1766 Step Collar for U5109 and U5153 High Security Cylinders.

Material: Stainless Steel

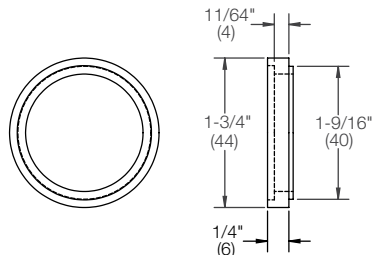

KP3 Wave Washer

(Furnished standard with 1765 collar for ASSA ABLOY ACCENTRA® KeyMark® cylinders only).



KP4 Flush Mount Cylinder Collar

Material: Brass, Bronze

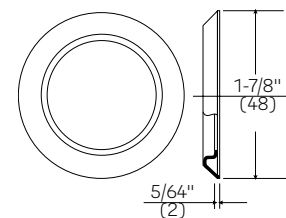

1767 Square Collar (provided standard with R9 rose)

"A" Dimension: See chart for available sizes. To order, specify "1767.size" i.e. 1767.XXX

Material: Brass, Stainless Steel

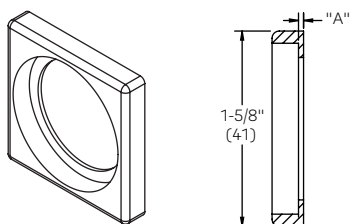

"A" Dimension	
Size	Specify
1/32	.042
1/8	.122
3/16	.192
1/4	.248
5/16	.310
3/8	.373
7/16	.436
1/2	.498
9/16	.560
5/8	.623
11/16	.703
25/32	.788

STRIKES

ASSA ABLOY ACCENTRA™ nexTouch® Keypad Sectional Mortise Locks come standard with a 2815 Curved Lip Strike with a 1-1/4" (32mm) lip length. The strike supplied will accommodate the locking function, i.e. latchbolt and/or deadbolt, and can be installed on doors 1-3/4" (44mm) thick. These strikes are non-handed.

Material: Brass, Bronze, Stainless Steel.

Longer/Shorter Lip Lengths: Mortise lock strikes are mounted 3/8" above the center line of the lock.

To determine the proper length of lip use the following formula:

1/2 of the door thickness, plus 1/16" inset, plus trim thickness, plus 1/8" for flat lip strike OR 1/4" for curved lip strike. Select the nearest available length.

2815 Curved Lip:

1-1/4" (32mm) standard
Available for special order:

1-1/8" (29mm)
1-3/8" (35mm)
1-1/2" (38mm)
1-5/8" (41mm)
1-3/4" (44mm)
1-7/8" (48mm)
2" (51mm)
2-1/8" (54mm)
2-1/4" (57mm)

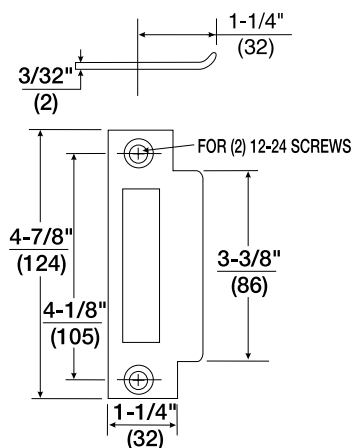

2815 Curved Lip Strike
1-1/4" (32mm) standard

2816 Flat Lip (Available for special order only):

7/8" (22mm)
1" (25mm)
1-1/8" (29mm)
1-1/4" (32mm)
1-1/2" (38mm)
1-3/4" (44mm)
2" (51mm)
2-1/4" (57mm)
2-1/2" (64mm)

DIMENSIONS

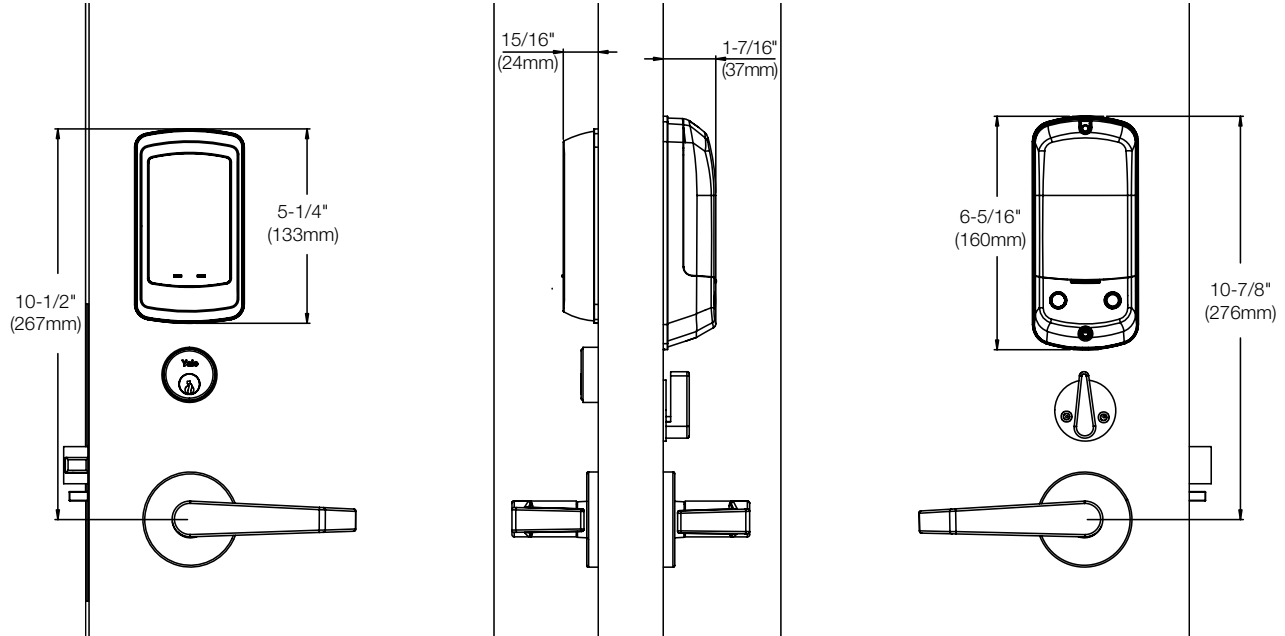

OPTIONS & ACCESSORIES

Model/Part Number	Description
784	Optional remote 9VDC power supply with plug-in wall transformer (used for hardwiring up to two nexTouch® locks).
WH-28	Remote unlock and power wire harness (used for hardwiring).
NTX600-ACC-KEY	ASSA ABLOY ACCENTRA™ module*

Hardwire Option Diagram

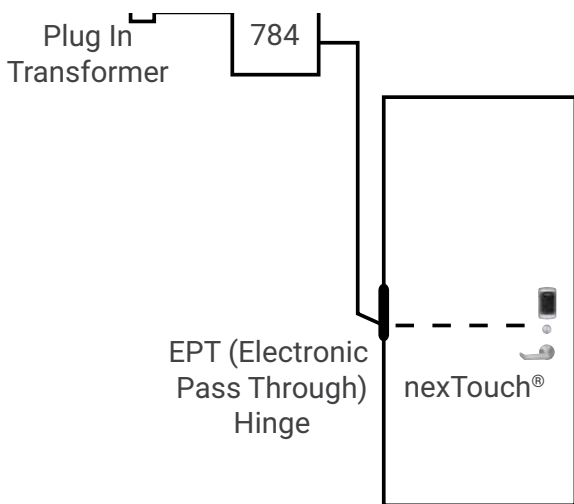

* This technology module can be used to upgrade stand-alone nexTouch® locks for use in the ASSA ABLOY ACCENTRA™ multi-family solution by enabling data-on-credential technology. This is included when ordering nexTouch® locks with ACC in the order string.



Scar Plate Kits

(Can be used to cover door preps for SARGENT Profile Series v.G1.5 and Corbin Russwin Access 800 series locksets to enable replacement with nexTouch)

Model/Part Number	Description
50-M600-0150-033	Scar plates, outside with cylinder, inside without thumbturn
50-M600-0151-033	Scar plates, outside without cylinder, inside without thumbturn
50-M600-0152-033	Scar plates, outside with cylinder, inside with thumbturn
50-M600-0153-033	Scar plates, outside without cylinder, inside with thumbturn

NOTE: Scar plate kits include 1 outside plate and 1 inside plate.

CERTIFICATIONS AND LISTINGS

ADA



The nexTouch® Series lever design meets accessibility guidelines of the Americans with Disabilities Act and the requirements of the Uniform Federal Accessibility Standards and ICC/ANSI A117.1 Accessible and Usable Buildings and Facilities, all requiring ease of accessibility.

ANSI/BHMA



nexTouch® mortise certified ANSI/BHMA A156.13, Series 1000 Grade 1.

Fire Listings



Functions are UL/cUL Fire Listed for use on fire doors having a rating up to and including 3 hours.

Note: Any retrofit or other field modification to a fire rated opening can potentially impact the fire rating of the opening, and ASSA ABLOY ACCENTRA™ Locks & Hardware makes no representations or warranties concerning what such impact may be in any specific situation. When retrofitting any portion of an existing fire rated opening, or specifying and installing a new fire-rated opening, please consult with a code specialist or local code official (Authority Having Jurisdiction) to ensure compliance with all applicable codes and ratings.

FCC

Complies with limits for a Class B digital device, pursuant to part 15 of the FCC Rules.

ISO 14001

Designed and manufactured under a certified ISO 14001 quality system.

Sustainability

EPD and GreenCircle certification.

Warranty

nexTouch® has a three-year limited warranty on the mechanical and electrical components, and a one-year limited warranty on the finish.

Windstorm

Certified (refer to local codes).



**CONTROL EXTERIOR DOOR
AND STAIRWELL ACCESS**

nexTouch® Keypad
Exit Trim



Technical Specifications

Door Specifications	Retrofits onto many exit device models, see chart above
Door Thickness	1-3/4" (44mm) door thickness standard, 2-1/4" also available
Handing	Field reversible
Cylinder	Accepts conventional, interchangeable core, security and high security cylinders, and other manufacturers' keyway cylinders
Keying	Capable of accepting ASSA ABLOY ACCENTRA™ 6-pin standard, small and large format interchangeable core, security and protected keyway cylinders with master keying capabilities
ANSI/BHMA	Certified ANSI/BHMA A156.3, Grade 1
UL/cUL	Functions are UL - cUL Fire Listed for use on fire doors having a rating up to and including 3-hours
Warranty	3-year electronic and mechanical, 1-year finish
Environmental Specifications	Operating temperature: -40°F to +140°F (-40°C to +60°C) at 95% relative humidity when used with an external power supply
Power Source	Four AA alkaline batteries (included) with optional hardwire input for 9VDC external power; 9V battery power backup
Credentials	Seos™ cards, fobs, and ASSA ABLOY ACCENTRA™ mobile credentials
Interface	Capacitive touchscreen or pushbutton
Firmware Upgradeability	Locks support on-premise wireless configuration and firmware upgrades



Pushbutton keypad option available

Compatible with a wide range of exit devices, including competitor models (see chart on page 45)



HOW TO ORDER

Exit Trim

Quantity	Lever Design	Series	Function	^Technology	Finish	Advanced Functions	Cylinder/Keyway	Hand*	Door Thickness
	AU – Augusta	NTT nexTouch® Keypad Exit Trim	613 - Pushbutton Keypad - Key Override	ACC - Data-on-Credential	605 – Bright brass, clear coated	DPS**	2153 cylinder keyed random standard, see pages 43-45 for additional options	RHR LHR	1-3/4" 2-1/4"
	MO – Monroe		623 - Capacitive Touch - Key Override		613E – Dark oxidized bronze - equivalent				
	PB – Pacific Beach				626 – Satin chrome plated BSP – Black suede powder coat				

*Lock is field reversible

**Use DPS option code for Advanced Functions. An auxiliary Door Position Sensor (DPS) must be installed with the lock to enable both Escape Return and Privacy functions. If DPS is not included in the parts string, the Door Position Sensor will not be supplied with the lock.

Note that selecting DPS option code will incur an upcharge. See current pricelist.

Build Your Order String

Quantity	Lever Design	Series	Function	^Technology	Finish	Advanced Functions	Cylinder/Keyway	Hand	Door Thickness
Example:	AU	NTT	623	ACC	626		2153	RHR	1-3/4"
Example:	PB	NTT	623	ACC	BSP	DPS	2153	LHR	1-3/4"

Packing

Each box has a paper door marker, combination wood and machine screws, four AA alkaline batteries, Allen wrench and easy-to-follow installation and programming instructions. Cylinder functions supplied with two keys. When ordered with ACC functionality, the NTX600-ACC-Key ASSA ABLOY ACCENTRA™ module is included in the box.

^nexTouch Accentra lock part numbers NTT613 & NTT623 can be used as a stand alone, keypad only function by removing the Accentra radio module from the lock. **These part numbers can NOT be upgraded for use with a Z-Wave compatible system.**

TRIM DESIGNS



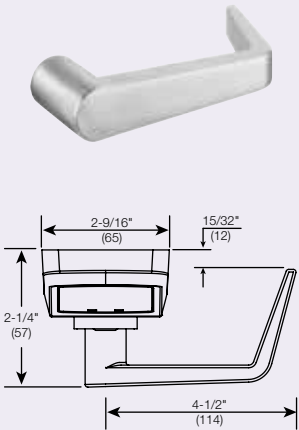
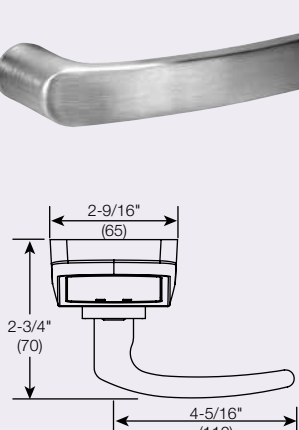
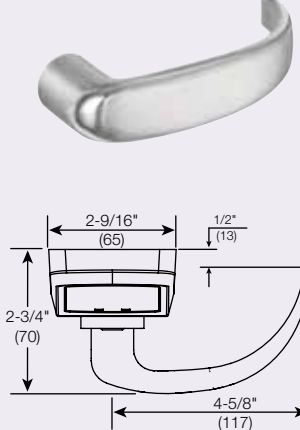

Exit Trim

<p>AUGUSTA AU* AU Lever Handle: Cast</p>	<p>MONROE MO MO Lever Handle: Cast</p>	<p>PACIFIC BEACH PB* PB Lever Handle: Cast</p>
		

*Meets California State Reference Code for lever return

FINISHES

Exit Trim

ANSI/BHMA Code Finish Description			
605 Bright Brass, Clear Coated	613E Dark Oxidized Satin Bronze - equivalent	626 Satin Chrome Plated	BSP Black Suede Powder Coat
			

FUNCTIONS

Exit Trim

NTT613 Pushbutton
NTT623 Touchscreen

No Deadbolt With Cylinder Override

- For doors that require mechanical key override.
- Bolt retracted by pushbar on interior and lever on outside except when outside lever is locked.
- Key override unlocks the outside lever only.
- Deadlocking rim bolt.

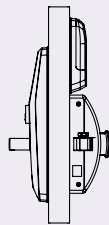

Outside

Inside

CYLINDERS

Exit Trim

Conventional Cylinders

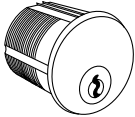
Illustration	Cylinder Model Number	Application	Cam	Length	
				6-Pin	7-Pin
	2153	Standard cylinder	2160	1-1/8"	1-1/4"

*Contact Technical Product Support for cylinder collar requirements when ordering these cylinders separately.

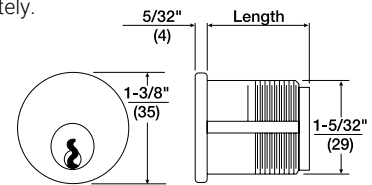

Interchangeable Core Mortise Cylinders

Cylinder Model Number	Application	Cam	Length	Pins	Housing Only Model Number	Core Only Model Number
2196	Standard Cylinder	2160	1-1/2"	6	2221	1210
2197	Standard Cylinder	2160	1-11/16"	7	2213	1220

Note: When ordering interchangeable core cylinders or cores only, control keys are not furnished. If control keys are required they must be ordered separately.

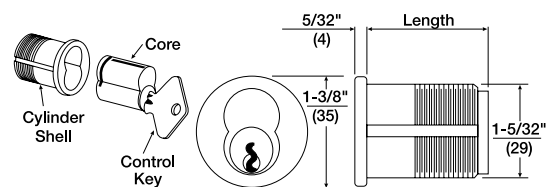

CYLINDERS

Exit Trim (Continued)

Security cylinders contain two independent locking mechanisms. The first is a traditional 6- or 7-pin tumbler mechanism with spool drivers for greatly increased picking resistance.

The second is an innovative 5-tumbler rotating disc mechanism with sidebar engagement. The rotating discs are spring-loaded and block the bottom of the keyway.

Illustration

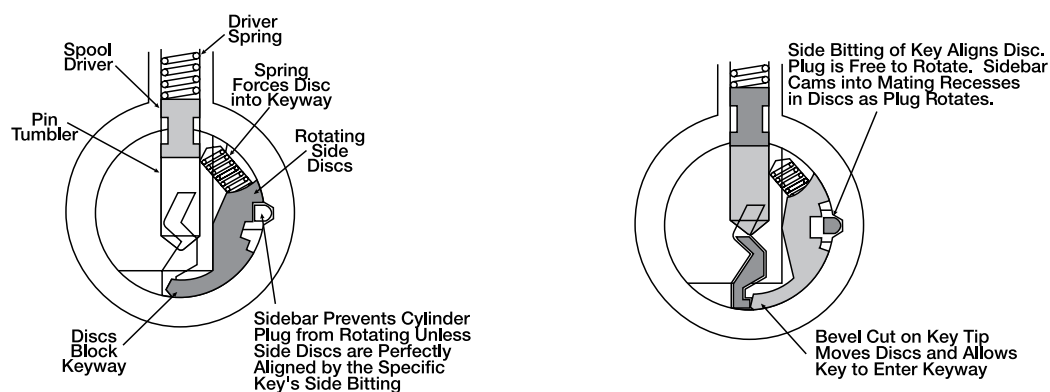

Security/High-Security Mortise Cylinders

Model Number	Application	Cam	Length	
			6-pin	7-pin
5153	Standard Cylinder	2160	1-1/8" 1-1/4"	1-1/4"

Security Interchangeable Core Mortise Cylinders

Cylinder Model Number	Application	Cam	Length	Pins	Housing Only Model Number	Core Only Model Number
5196	Standard Cylinder	2160	1-1/2"	6	2221	5210
5197	Standard Cylinder	2160	1-11/16"	7	2213	5220

Note: When ordering interchangeable core cylinders or cores only, control keys are not furnished. If control keys are required they must be ordered separately.

CYLINDERS

Exit Trim (Continued)

Other Manufacturers' Keyway Cylinders/Cores

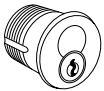
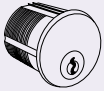
Illustration	Model Number	Type	Cam	Length	Pins	Housing Only Model Number	Core Only Model Number
	A620	Small Format IC Mortise, includes Best® Keyway Core. Available keyed random, master keyed or uncombined. Specify keyway A, B, C, D, E, F, G, H, J, K, L or M.	KC1	1-1/4"	6	K660	A600
				1-3/8"	6 or 7		
	2553	Fixed Core Mortise Schlage® "C" Keyway Cylinder. Available 0-bitted or keyed random.	2160	1-1/8"	6	N/A	N/A

ASSA ABLOY ACCENTRA™ KeyMark®

For those applications requiring protected key control, ASSA ABLOY ACCENTRA™ KeyMark® cylinders guard against unauthorized key duplication. The ASSA ABLOY ACCENTRA KeyMark Security Leg® keyway feature increases resistance against picking and impressing and can easily retrofit into existing systems. For further details and availability, refer to the separate ASSA ABLOY ACCENTRA™ KeyMark catalog.

Protected Keyway Mortise Cylinders

Model Number	Type	Cam	Length	Pins	Housing Only Model Number	Core Only Model Number
K100	Fixed Core Mortise	KC1	1-1/8"	6 or 7	N/A	N/A
K820	Large Format IC Mortise	KC1	1-1/2"	6	K860	K800
			1-11/16"	7		
K620	Small Format IC Mortise	KC1	1-1/4"	6	K660	K600
			1-3/8"	6 or 7		

CYLINDER COLLARS

Exit Trim

Cylinder collars are supplied as standard where required with those locksets supplied with cylinders. Collar size and thickness are supplied to suit the length of the cylinder, the thickness of the door and the trim ordered. (If door thickness is not specified, collars will be furnished for 1-3/4" (44mm) door.)

Collar length required must be specified for cylinders and/or housings ordered separately.

1765 Recessed Cylinder Collar

"A" Dimension: Thicknesses available in 1/16" (2mm) increments from 1/16" (2mm) to 1-15/32" (37mm) as required.

Material: Brass, Stainless Steel

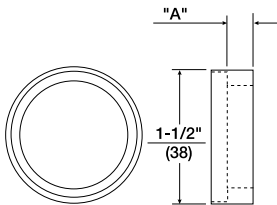

DIMENSIONS AND COMPATIBLE EXIT DEVICES

Exit Trim

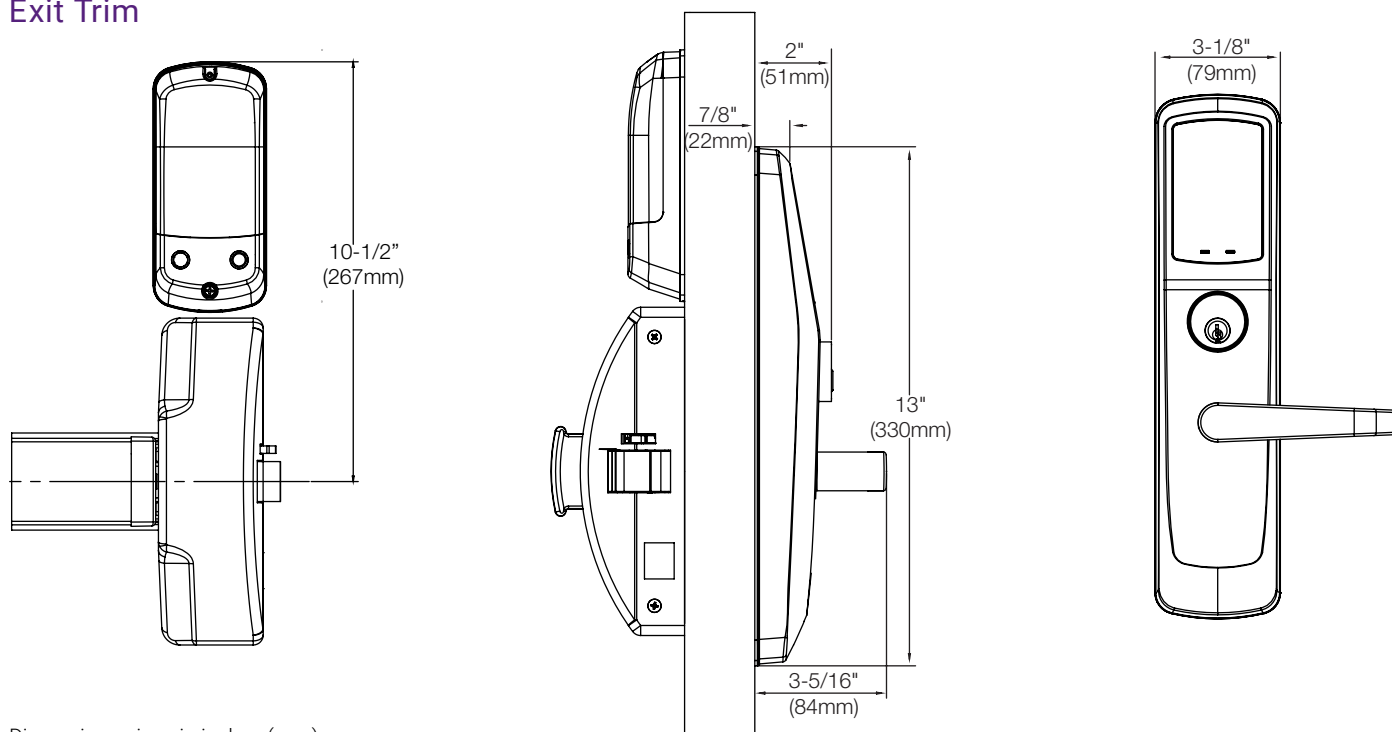

Dimensions given in inches (mm).

Compatible Exit Devices

Thanks to its patented adjustable mounting posts, ASSA ABLOY ACCENTRA™ nexTouch® exit trim is compatible with several makes and models of exit devices right out of the box, without the need for separate mounting hardware. Check the chart below to see if yours is a fit.

Manufacturer	Model/Series Number*
Arrow	3880, S1250
Corbin Russwin	PED/ED5200, PED/ED5200S
Dorma	9300
Falcon®	25
SARGENT	PE8800/8800
Von Duprin®	98, 99
ASSA ABLOY ACCENTRA™	1800, 2100/2150, 6100/6150, 7100/7150

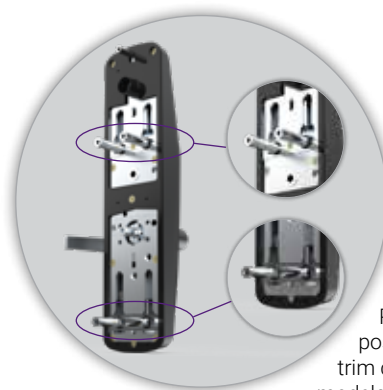

Patented adjustable mounting posts make the nexTouch® exit trim compatible with many exit device models (see chart at left).

*Compatible with rim device only. Please contact Technical Product Support for more information.

COMPATIBLE EXIT DEVICES

7000 Series Architectural Exit Device

The ASSA ABLOY ACCENTRA™ 7000 Series delivers an unparalleled combination of durability, innovation and aesthetics.



Features

- Premium exit device with high quality steel chassis and heavy-duty components
- Sleek design with a variety of finish options
- ANSI/BHMA Grade 1 Certified
- UL/cUL listed for panic and fire doors
- Windstorm certified
- Five-year mechanical warranty

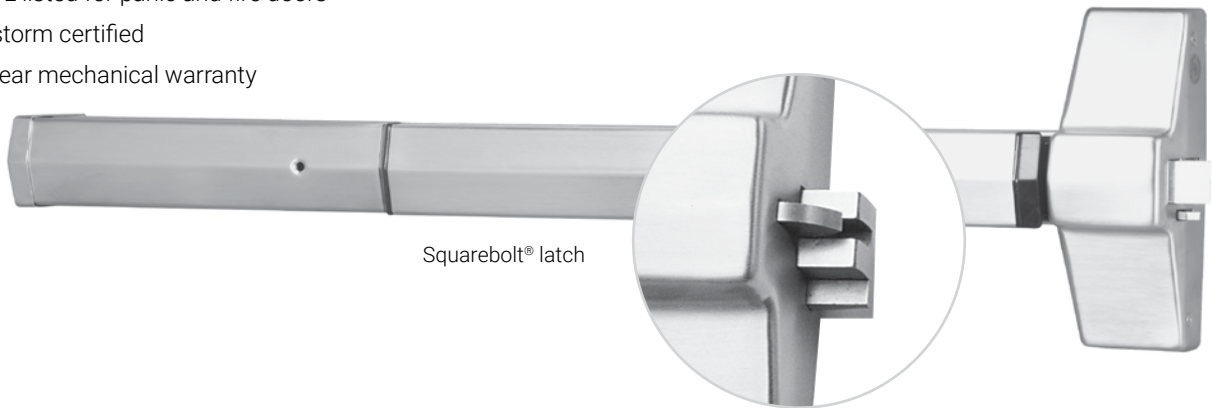

Finishes

ANSI/BHMA Code Finish Description			
605 Bright Brass, Clear Coated	613E Dark Oxidized Satin Bronze - equivalent	630 Satin Stainless Steel	BSP Black Suede Powder Coat

How To Order

Model #	Size	Finish	Handing
7100F – Rim, fire-rated	36 – Door widths from 36" to 42"	605 – Bright brass	RHR
7150FWS – Squarebolt®, fire-rated	48 – Door widths from 42" to 48"	613E – Dark satin bronze equivalent	LHR
		630 – Satin stainless steel	
		BSP – Black suede powder coat	

COMPATIBLE EXIT DEVICES

6000 Series Commercial Exit Device

The ASSA ABLOY ACCENTRA™ 6000 Series offers clean, modern lines and smooth, quiet operation in any application.



Features

- Attractive modern design available in a range of finishes
- Uniquely engineered for smooth operation and noise reduction
- ANSI/BHMA Grade 1 Certified
- UL/cUL listed for panic and fire doors
- Ten-year mechanical warranty



Finishes

ANSI/BHMA Code Finish Description			
605 Bright Brass, Clear Coated	613E Dark Oxidized Satin Bronze - equivalent	630 Satin Stainless Steel	BSP Black Suede Powder Coat
			

How To Order

Model #	Size	Finish	Handing
6100F – Rim device, fire-rated 6150F – Squarebolt®, fire-rated	36 – Door widths from 36" to 42" 48 – Door widths from 42" to 48"	605 – Bright brass 613E – Dark satin bronze equivalent 630 – Satin stainless steel BSP – Black suede powder coat	RHR LHR

COMPATIBLE EXIT DEVICES

2100 Series Economy Exit Device

2100 Series Exit Devices from ASSA ABLOY ACCENTRA™ feature sturdy construction for reliable function in economy applications.



Features

- Strong and reliable design meets the rigors of demanding environments
- High grade steel components
- ANSI/BHMA Grade 1 Certified
- UL/cUL listed for panic and fire rated doors
- Three-year mechanical warranty

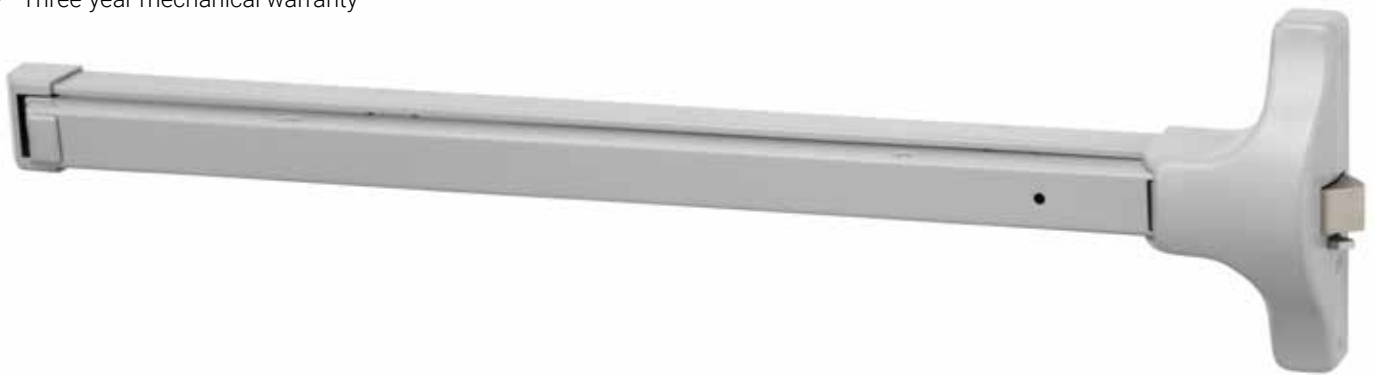

Finishes

ANSI/BHMA Code Finish Description		
613E Dark Oxidized Satin Bronze - equivalent	630 Satin Stainless Steel	BSP Black Suede Powder Coat
		

How To Order

Model #	Size	Finish	Handing
2100F – Rim device, fire-rated	36 – Door widths from 36" to 42" 48 – Door widths from 42" to 48"	613E – Dark satin bronze equivalent 630 – Satin stainless steel BSP – Black suede powder coat	RHR LHR

OPTIONS AND ACCESSORIES

Exit Trim

Model/Part Number	Description
784	Optional remote 9VDC power supply with plug-in wall transformer (used for hardwiring up to two nexTouch® locks).
WH-28	Remote power and request to enter wire harness.
NTX600-ACC-KEY	ASSA ABLOY ACCENTRA™ module*
14-B600-0111-999	3-Wire Door Position Sensor

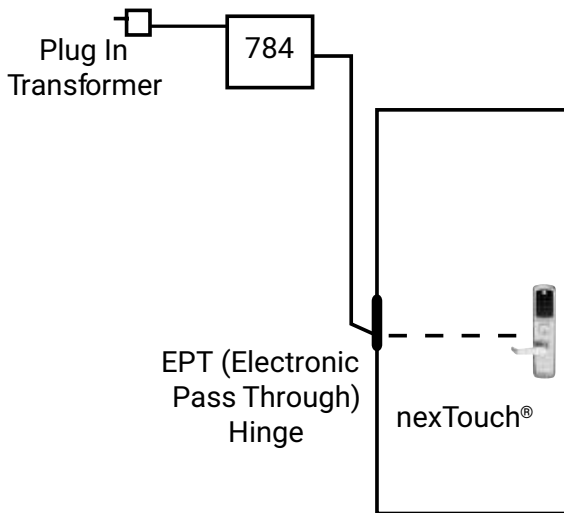

*This technology module can be used to upgrade stand-alone nexTouch® locks for use in the ASSA ABLOY ACCENTRA™ multi-family solution by enabling data-on-credential technology. This is included when ordering nexTouch® locks with ACC in the order string.



CERTIFICATIONS AND LISTINGS

Exit Trim

ADA



The nexTouch® Series lever design meets accessibility guidelines of the Americans with Disabilities Act and the requirements of the Uniform Federal Accessibility Standards and ICC/ANSI A117.1 Accessible and Usable Buildings and Facilities, all requiring ease of accessibility.



ANSI/BHMA

nexTouch® mortise certified ANSI/BHMA A156.13, Series 1000 Grade 1.

Fire Listings



Functions are UL/cUL Fire Listed for use on fire doors having a rating up to and including 3 hours.

Note:

Any retrofit or other field modification to a fire rated opening can potentially impact the fire rating of the opening, and ASSA ABLOY ACCENTRA™ Locks & Hardware makes no representations or warranties concerning what such impact may be in any specific situation. When retrofitting any portion of an existing fire rated opening, or specifying and installing a new fire-rated opening, please consult with a code specialist or local code official (Authority Having Jurisdiction) to ensure compliance with all applicable codes and ratings.

FCC

Complies with limits for a Class B digital device, pursuant to part 15 of the FCC Rules.

ISO 14001

Designed and manufactured under a certified ISO 14001 quality system.

Warranty

nexTouch® has a three-year limited warranty on the mechanical and electrical components, and a one-year limited warranty on the finish.

**CONTROL ACCESS TO
RESIDENT DOORS**

nexTouch®
Interconnected Lock



Shown with Valdosta lever

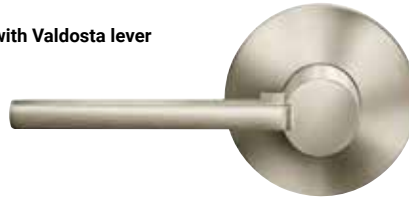

Technical Specifications

Door Specifications	2-1/8" Face Bore, 1" Edge Bore, 4" or 5-1/2" Center to Center
Backset	2-3/8" (60mm) or 2-3/4" (70mm)
Door Thickness	1-3/8" (35mm) to 1-3/4" (44mm)
Handing	Field reversible
Latch Faceplate	1" (25mm) W x 2-1/4" (57mm) H; round corner standard, square corner available to order
Strike	2-1/4" (57 mm) full lip; round corner standard, other strikes available to order
Cylinder	KW-1 compatible standard, other cylinders/keyways available to order
Keying	KD (Keyed Different) standard, master keying available to order
Packing	Box pack
ANSI/BHMA	Certified ANSI/BHMA A156.12, Grade 2
UL/cUL	Listed for 90 minute fire doors
Warranty	3-year electronic and mechanical, 1-year finish
Environmental Specifications	Outside temperature range: -22°F to +140°F (-30°C to +60°C), Inside temperature range: 5°F to +158°F (-15°C to +70°C), Battery temperature range: -14°F to +131°F (-10°C to +55°C), Storage temperature range: -40°F to +85°F (-40°C to +85°C)
Power Source	Four AA alkaline batteries, included
Credentials	Seos™ cards, fobs, and ASSA ABLOY ACCENTRA™ mobile credentials
Firmware Upgradeability	Locks support on-premise wireless configuration and firmware upgrades



Capacitive Touchscreen

Press ASSA ABLOY logo to wake the lock

Voice Assisted Programming

Touchscreen shown when activated



Low Battery Indicator

Lockout Indicator

Rubber seal protects your door and shields your lock from weather elements.

Solid Metal Escutcheon - Provides quality and durability

Emergency key override

Privacy Button - Prevents unwanted access from the outside at the touch of a button



Motorized tapered deadbolt with anti-cut hardened steel pin

Latchbolt and deadbolt are retracted simultaneously in a single motion for quick and easy egress

HOW TO ORDER

Use this outline to build the model number for the nexTouch® Interconnected Lock you require.

Function	Technology	Lever	Center to Center	Cylinder	Latch	Finish**	Handing
NTC623 – Touchscreen interconnected lock	ACC – Data-on-Credential	AU – Augusta	4 - 4"	KA – KW keyed alike	RC – Radius Corner	619 – Satin Nickel Plated, Clear Coated (US15)	RH
		DE – Delaware	5 - 5-1/2"	KD – KW keyed different	SC – Square Corner	0BP – Oil Rubbed Bronze - Permanent (US10BP)	LH
		MO – Monroe		PA – PARA keyed alike			
		NW – Norwood		PD – PARA keyed different			
		PB – Pacific Beach		SA – SC keyed alike			
		VL – Valdosta		SD – SC keyed different			
				SF – SFIC*		BSP – Black Suede Powder Coat	

*When ordering SFIC with the interconnected lock, the lock will ship with the SFIC cylinder housing factory installed and it will ship less cylinder.

**Split finish can be ordered by specifying outside finish/inside finish, e.g. 619/0BP would result in all exterior hardware in 619 and all interior and strike hardware in 0BP

Build Your Order String

Quantity	Function	Technology	Lever Design	Center to Center	Cylinder	Latch	Finish	Handing
Example:	NTC623	ACC	NW	4	KD	RC	619	RH

Notes:







- The nexTouch® interconnected lock comes standard with three latches:
 - One adjustable backset deadbolt latch
 - One 2-3/8" backset lever latch
 - One 2-3/4" backset lever latch
- Non-standard latches must be ordered separately.
- Latches shipped as radius corner unless otherwise specified. See options for availability.
- All master key, builder key or keyed alike requests must be added to the order as a note.
- BSP locks ship with BSP finished installation hardware.

Packing

Each box includes a paper door marker, combination wood and machine screws, four AA Alkaline batteries, Allen wrench, lever removal tool, hardware accessories, cylinder functions supplied with two keys, and easy-to-follow installation and programming instructions.

nexTOUCH® INTERCONNECTED LOCK

Lever Designs

AUGUSTA AU	DELAWARE DW	MONROE MO
 	 	 
NORWOOD NW	PACIFIC BEACH PB	VALDOSTA VL
 	 	 

Finishes

ANSI/BHMA Code Finish Description		
619 (US15) Satin Nickel Plated, Clear Coated	0BP (US10BP) Oil Rubbed Bronze - Permanent	BSP – Black Suede Powder Coat
		

BSP locks ship with BSP finished installation hardware.

Functions

NTC623

Passage with Touchscreen

- Uses nexTouch® touchscreen.
- Single point lock.
- Latchbolt retracted by lever outside with presentation of valid credential, with valid PIN code, or by operating lever inside.
- Deadbolt activated electronic touchscreen interaction or by key outside; inside by T-turn.
- Interior lever retracts latch and deadbolt simultaneously.



DIMENSIONS

Center to Center Dimensions

Electronic

All electronic locksets available as 4" or 5-1/2" center to center dimension. Must be ordered this way from the factory and are not field changeable

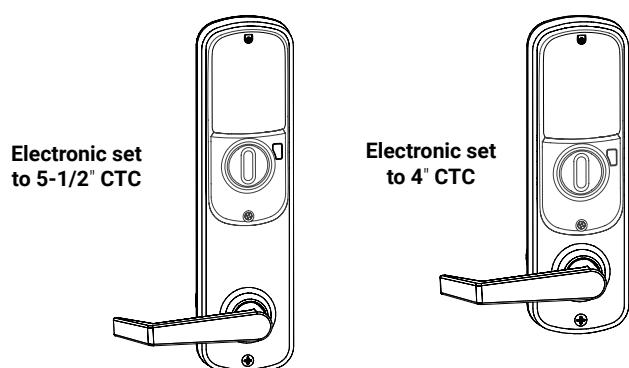

Product Dimensions

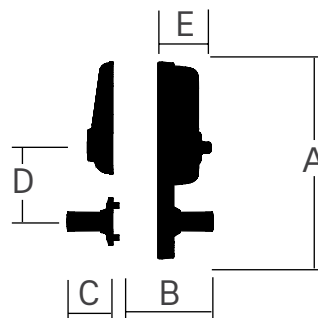

Dimensions				
A	B	C	D	E
10-5/8" 12-1/8"	2-5/8"	2-1/2"	4" 5-1/2"	2-13/16"

CYLINDERS

Fixed Core

Keyway	Description	Model Number	Number of Pins
Kwikset	Available KD, KA, MK	AYRD200-KW*	5
ASSA ABLOY ACCENTRA™ PARA	Available 0-bitted, KD, KA, MK, BK	YRLPARA*	6
Schlage® C	Available 0-bitted, KD, KA, MK	AYRD200-SC*	5

Note: Please indicate special keying requests such as builder keying (BK) or master keying (MK) on your order.

*Specify finish and keying.

Interchangeable Core

When ordering SFIC with the interconnected lock, the lock will ship with the SFIC cylinder housing factory installed and it will ship less cylinder. Cores can be ordered separately using model numbers A600 or K600.

LATCHBOLTS

Lockset Latches

Plain latchbolts are supplied for the lockset of the interconnected lock.

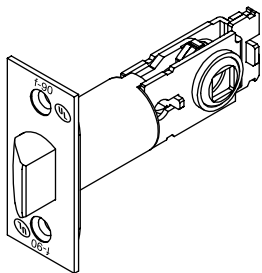

Plain					
Part No.	Front	Backset	Front Width	Throw	Latch Diameter*
YR01802*U	Round	2-3/8" (60mm)	1" (25mm)	1/2" (13mm)	7/8" (22mm)
YR01804*U	Square	2-3/8" (60mm)	1" (25mm)	1/2" (13mm)	7/8" (22mm)
YR01806*U	Round	2-3/4" (70mm)	1" (25mm)	1/2" (13mm)	7/8" (22mm)
YR01808*U	Square	2-3/4" (70mm)	1" (25mm)	1/2" (13mm)	7/8" (22mm)

*Specify finish when ordering:

619
10BP
BSP

Note: All latchbolts are only available with flat fronts, not recommended for beveled doors. 1-1/8" latch filler provided.

Deadbolt Latches

Adjustable backset deadbolt latches are supplied standard for the deadbolt of the interconnected lock.

Model No.	Description	Front	Backset	"W" Front Width	Throw
AYRDB-R90 *	Adjustable deadbolt latch	Round	Adjustable [^]	1" (25mm)	1" (25mm)
AYRDB-SQ90*	Adjustable deadbolt latch	Square	Adjustable	1" (25mm)	1" (25mm)

* Specify finish (619, 10BP, BSP)

[^]Adjustable between 2-3/8" and 2-3/4" BSP

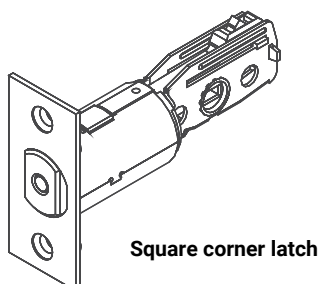
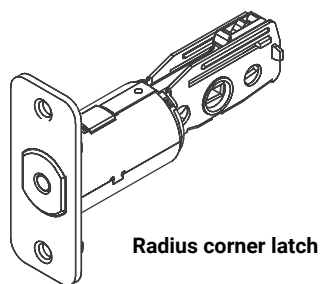

STRIKES

nexTouch® interconnected locks are available with a variety of strike options. All strikes are located on the same vertical and horizontal center lines as the latchbolt and deadbolt. All strikes are reversible. Strikes are fabricated of either brass, bronze or stainless steel, depending on the lockset trim finish. When ordering strikes separately, please specify the finish required.

Lockset

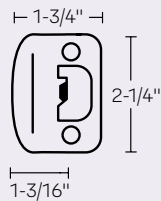

Model No. YR02000* Full Lip Strike Radius Corner

Standard. Plastic strike dust box available separately.

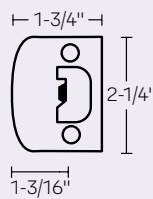

Model No. YR02001* Full Lip Strike Square Corner

Optional. Plastic strike dust box available separately.

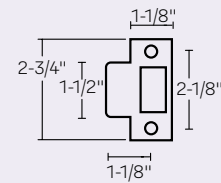

Model No. YR02020* T-Strike

Optional. Plastic strike dust box available separately.

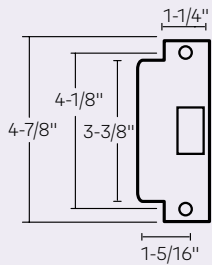

Model No. YR02030* ANSI 4-7/8 Strike

Optional. Plastic strike dust box available separately.

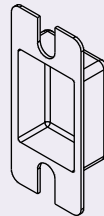

Model No. YR026003 Plastic Strike Dust Box

Available separately.

Deadbolt

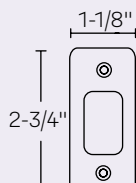

Model No. AYRD-SCREW* Deadbolt Strike Radius Corner with Screw Pack

Standard.

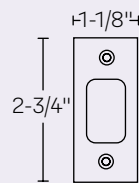

Model No. YR02086* Universal Deadbolt Strike Square Corner

Optional strike available for all mechanical units. Plastic strike dust box available separately.

*Specify finish when ordering strikes separately:

619
10BP

Note: See ASSA ABLOY ACCENTRA™ price catalog for additional optional deadbolt strikes.

NOTES

CONTROL ACCESS TO RESIDENT DOORS

nexTouch® Digital Deadbolt



Technical Specifications

Door Specifications	2-1/8" face bore, 1" edge bore
Backset	2-3/8" or 2-3/4" backset
Door Thickness	1-3/8"* to 2-1/4" * Thin door kit required for 1-3/8" thick doors
Handing	Auto handing after installation
Latch	2-3/8" to 2-3/4" adjustable
Latch Faceplate	1" x 2-1/4" RC (round corner)
Strike	1-1/8" x 2-3/4" RC (round corner)
Cylinder	KW-1 compatible standard, other cylinders/keyways available to order
Keying	KD (Keyed Different) standard, master keying available to order
Packing	Box pack
ANSI/BHMA	Certified ANSI/BHMA A156.36, Grade 2
UL/cUL	Functions are UL - cUL Fire Listed for use on fire doors having a rating up to and including 90 minutes
Warranty	3-year electronic and mechanical, 1-year finish
Environmental Specifications	Outside temperature range: -22°F to +140°F (-30°C to +60°C), Inside temperature range: 5°F to +158°F (-15°C to +70°C), Battery temperature range: -14°F to +131°F (-10°C to +55°C), Storage temperature range: -40°F to +85°F (-40°C to +85°C)
Power Source	Four AA alkaline batteries, included
Credentials	Seos™ cards, fobs, and ASSA ABLOY ACCENTRA™ mobile credentials
Firmware Upgradeability	Locks support on-premise wireless configuration and firmware upgrades

Capacitive Touchscreen

Press ASSA ABLOY logo to wake the lock

Voice Assisted Programming

Touchscreen shown when activated



Low Battery Indicator

Lockout Indicator

Solid Metal Escutcheon - Provides quality and durability

Motorized tapered deadbolt with anti-cut hardened steel pin

Emergency key override

Rubber seal protects your door and shields your lock from weather elements.

Privacy Button - Prevents unwanted access from the outside at the touch of a button



Note: Mechanical locks, including levers, are sold separately.

HOW TO ORDER & FINISHES

How To Order

Use this outline to build the model number for the nexTouch® Digital Deadbolt you require.

Function	Strike/Latch	Technology	Cylinder ¹	Finish
NTD623 – ACC	Standard - Round Corner 699A - Square Corner	ACC - data-on-card	Standard - KR Keyed Random KA – Keyed Alike OB - 0-Bitted (Schlage and PARA only) MK - Master Keyed CMK - Construction Master Keyed (PARA only)	619 – Satin Nickel, Clear Coated (US15) OBP – Oil Rubbed Bronze - Permanent (US10BP) BSP – Black Suede Powder Coat

1. SFIC cylinder housing can be ordered using part number 14-D600-6005-FIN. Please specify finish. SFIC housing ships separately as an accessory, is supplied less cylinder, and must be field-installed.

Build Your Order String

Quantity	Function	Strike/Latch	Keyway	Keying	Finish
10	NTD623-ACC	699A	PARA	OB	BSP

Finishes

ANSI/BHMA Code Finish Description		
619 (US15) Satin Nickel Plated, Clear Coated	OBP (US10BP) Oil Rubbed Bronze - Permanent	BSP – Black Suede Powder Coat
		

Notes:

- The nexTouch® digital deadbolt comes standard with a round corner adjustable deadbolt latch.
- Doors less than 1-3/4" thick require a thin door kit. See page 63.
- BSP locks ship with BSP finished installation hardware.

Packing

Each box includes a paper door marker, combination wood and machine screws, four AA Alkaline batteries, strike plate, cylinder functions supplied with two keys, and easy-to-follow installation and programming instructions.

DIMENSIONS

**nexTouch®
 Touchscreen
 Deadbolt
 Exterior**

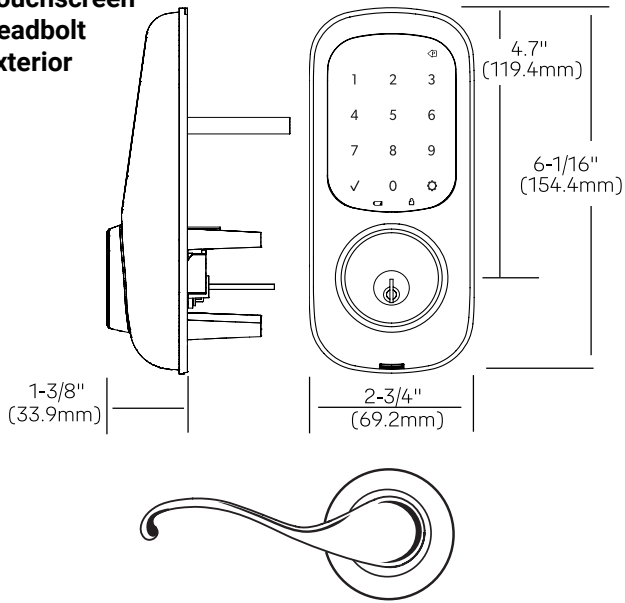

nexTouch® Lock Interior

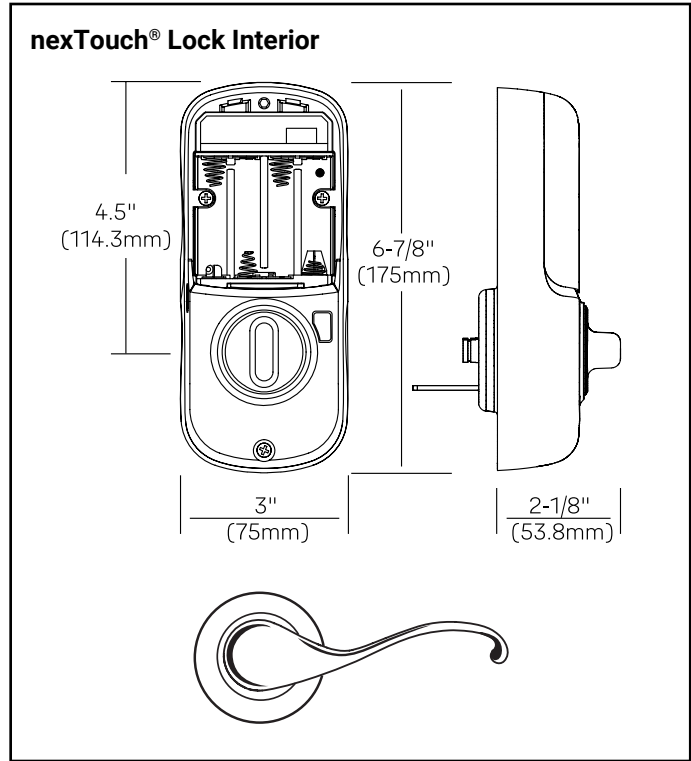

CYLINDERS

Fixed Core

Cylinder	Description	Model Number	Number of Pins
Kwikset	Available KR, KA, MK	3809-178S*	5
ASSA ABLOY ACCENTRA® PARA	Available 0-bitted, KR, KA, MK, BK	1809-178S*	6
Schlage® C	Available 0-bitted, KR, KA, MK	2809-178S*	5

Note: Please indicate special keying requests such as builder keying (BK) or master keying (MK) on your order.
*Specify finish.

Thin Door Kit

Part Number: TDT226

Thin door kit required for doors under 1-3/4" in thickness.

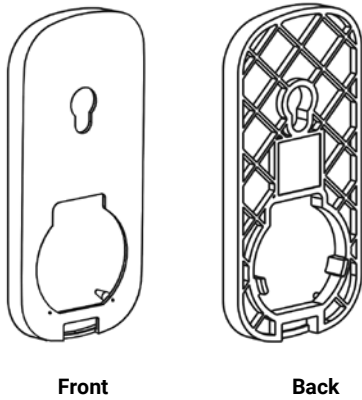

STRIKES

Deadbolt

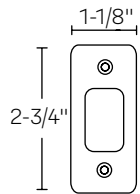

Model No. 498* Deadbolt Strike Radius Corner with Screw Pack

Standard strike.

Specify finish when ordering strikes separately:

- "6" - 619
- "B" - 10BP

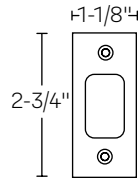

Model No. 499* Universal Deadbolt Strike Square Corner

Optional strike available for all electromechanical units. Plastic strike dust box available separately.

LATCHBOLTS

Deadbolt Latches

Adjustable backset radius corner deadbolt latch is supplied standard. Square corner latch and strike plate must be ordered separately.

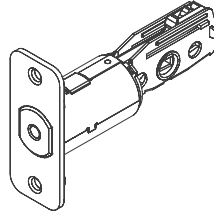

Model No.	Description	Front	Backset	"W" Front Width	Throw
698R*	Adjustable deadbolt latch	Round	Adjustable^	1" (25mm)	1" (25mm)
699A*	Adjustable deadbolt latch	Square	Adjustable	1" (25mm)	1" (25mm)

* Specify finish (619, 0BP, BSP). BSP finished hardware ships with 10BP strikes and BSP latch.

^Deadbolt latches are adjustable between 2-3/8" and 2-3/4". Drive-in not pictured.

SUITING YOUR HARDWARE

ASSA ABLOY ACCENTRA™ Commercial is available in unique finishes that suite through your facility no matter which door you're outfitting. See the matrix below to reference similar matches across product lines.

Finish	Black Suede Powder Coat	Satin Nickel Plated, Clear Coated	Satin Chrome Plated	Satin Stainless Steel	Dark Oxidized Satin Bronze Equivalent	Oil Rubbed Bronze	Bright Brass, Clear Coated
Code	BSP	US15	626	630	613E	OBP	605
nexTouch® Products (Cylindrical, Mortise, Exit Trim)	X		X		X		X
Exit Devices	X			X	X		X
nexTouch® Products (Deadbolt and Interconnected)	X	X				X	

ANSI/BHMA Code Finish Description			
BSP Black Suede Powder Coat	US15 Satin Nickel Plated, Clear Coated	626 Satin Chrome Plated	630 Satin Stainless Steel
			
613E Dark Oxidized Satin Bronze - equivalent	OBP Oil Rubbed Bronze	605 Bright Brass, Clear Coated	
			

The ASSA ABLOY Group is the global leader in access solutions.
Every day, we help billions of people experience a more open world.

ASSA ABLOY Opening Solutions leads the development within door openings and products for access solutions in homes, businesses and institutions. Our offering includes doors, frames, door and window hardware, mechanical and smart locks, access control and service.

ACCENTRA
ASSA ABLOY

TECHNICAL SUPPORT

(troubleshooting, product use and application, returns)
Tel: 800.810.WIRE (9473)
Email: 800810WIRE@assaabloyusa.com

CUSTOMER SUPPORT

(orders, product configuration, pricing, lead-time)
Tel: 866-889-6242, select Option 2
Fax: 203-603-5981
Email: ESS.Orders@assaabloy.com

U.S.A.:
ASSA ABLOY ACCENTRA™
225 Episcopal Road,
Berlin, CT 06037-4004
Tel: 1-800-438-1951
Fax: 1-800-338-0965
www.accentra-assaabloy.com

Canada:
ASSA ABLOY Door Security Solutions Canada
160 Four Valley Drive
Vaughan, Ontario L4K 4T9
Tel: 1-800-461-3007
Fax: 1-800-461-8989
assaabloydss.ca

International:
ASSA ABLOY Americas International
Tel: 1-905-821-7775
Fax: 1-905-821-1429
assaabloyai.com