

## introduction

New Traditions® from Yale® outstanding strength, durability and simple, elegant designs highlighted by natural curves for comfort and ease of turning. All *New Traditions* products are built on a steel ANSI/BHMA Grade 3 chassis and feature concealed holding screws and solid brass cylinder assemblies. In addition, all *New Traditions* products feature Quick-Install™, a unique chassis design, which drastically reduces installation time.

Note: *New Traditions* are not for use with commercial hollow metal doors.

## warranty

When used in commercial, institutional or industrial applications, *New Traditions* locksets carry a three-year mechanical and one-year finish warranty.

## ansi/bhma

Certified ANSI/BHMA Grade 3 

## pre-installed screws

Pre-Started screws makes installation quick and easy.

## concealed screws

Provide a clean consistent look.

## interior snap on-off knobs and levers

Saves installation time and reduces chance of scratches.

## brass cylinder standard

Reduces wear and provides smooth operation.

## non-handed levers

Easily field reversible for installation in applications of either hand.

## standard case quantities

	Box Pack (SP)	Clear View (CV)
Dummy	12	6
Knobs	24	6
Levers	12	6
Deadbolts	12	6
Combo Sets	12	6
Handlesets	6	6
Handlesets - Interior Pack	6	N/A

When ordering, specify the exact number of individual units required. For example, if there are 24 units in a case and 1 case is required, specify 24. See page 21 for How to Order.

## contents

Knobs . . . . .	3-4
Levers . . . . .	5-6
Deadbolts . . . . .	7-8
Handlesets . . . . .	9-10
Interconnected . . . . .	11-12
Cylinders/Keying . . . . .	13-14
Latchbolts . . . . .	15-16
Strikes . . . . .	17
Accessories . . . . .	18-19
How to Order . . . . .	.20
Handing of Doors . . . . .	.20

## finishes

ANSI/BHMA Code	Finish Description	US Code
605	Bright Brass	US3
609	Satin Brass, Blackened, Satin Relieved, Clear Coated	US5
613	Dark Oxidized Satin Bronze, Oil Rubbed	US10B
613e	Dark Oxidized Satin Bronze, Permanent	US10BP
619	Satin Nickel Plated, Clear Coated	US15
620	Satin Nickel Plated, Blackened, Satin Relieved, Clear Coated	US15A
625	Bright Chrome Plated	US26
626	Satin Chrome Plated	US26D

Finish Code	Description
GM	Gun Metal
TB	Textured Black

## handleset product specifications

### Door Specs

2-1/8" Face Bore  
1" Edge Bore  
5-1/2" O.C.

#### Box Pack:

Latch Face  
1" x 2-1/4" RC (Round Corner)

#### Clear Pack:

Latch Face  
1" x 2-1/4" SC (Square Corner)

### Latch

#### Box Pack:

2-3/8" RC (Round Corner)

#### Deadbolt:

2-3/8"-2-3/4" ADJ.  
RC (Round Corner)

#### Clear Pack:

Spring Latches  
2-3/8" and 2-3/4" SC (Square Corner)

#### Deadbolt:

2-3/8"-2-3/4" ADJ.  
SC (Square Corner)

### Door Thickness

1-3/8" to 1-3/4"  
2" to 2-1/4" Requires Ext. Kit 07600

### Cylinder

Brass 5 Pin Cylinder  
(KW-1 Compatible)

### Keying

#### Box Pack:

KD (Keyed Different)

#### Clear Pack:

KD (Keyed Different)

### Faceplate

1" x 2-1/4"  
RC (Round Corner)

### Strike

#### Box Pack:

Spring latch  
2-1/4" Full Lip RC (Round Corner)

#### Deadbolt:

1"x 2-1/4"  
RC (Round Corner)

#### Clear Pack:

Spring latch  
2-1/4" Full Lip SC (Square Corner)

#### Deadbolt:

1"x 2-1/4"  
SC (Square Corner)

### Hardware Handing

Handlesets are non-handed. Specify right-handed or left-handed for lever interior only.

### Interior Trim

**Box Pack and Clear Pack:** Cirrus Knob

**Note:** See pages 13-17 for optional cylinders, latchbolts and strikes.

## handleset designs

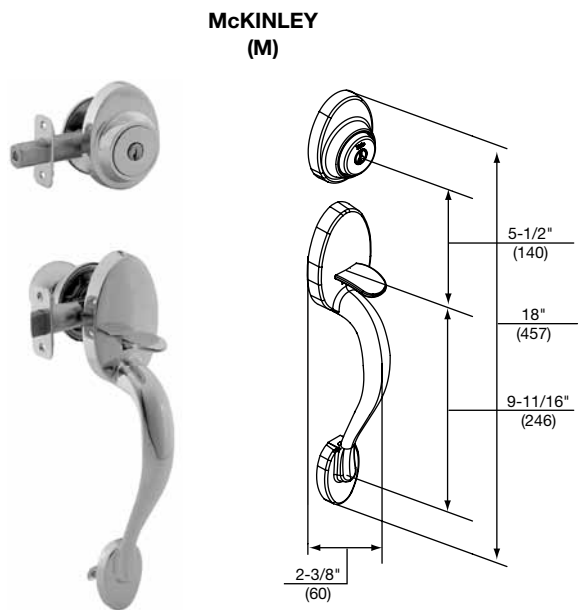
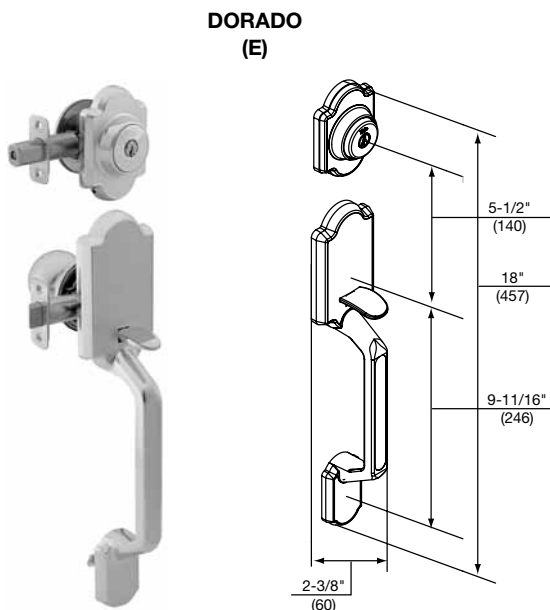

## handleset designs

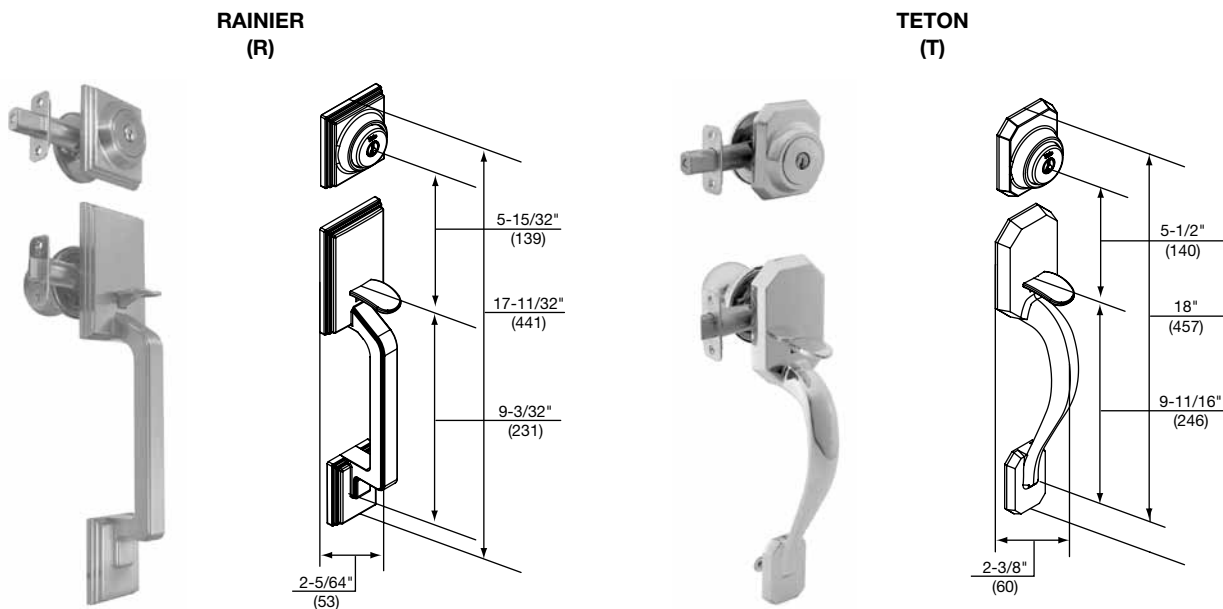

## functions

581/681/682/683	521/621/622/623	541/641/642/643
<b>Dummy:</b> For on-working side of double doors. Non-functioning deadbolt, knob or lever.	<b>Single Cylinder:</b> Thumbpiece retracts latch from exterior side. Knob or lever retracts latch from interior side. Deadbolt latch retracts with key from exterior side, thumbturn retracts deadbolt latch from interior side.	<b>Double Cylinder:</b> Thumbpiece retracts latch from exterior side. Knob or lever retracts latch from interior side. Deadbolt latch retracts with key from exterior side and interior side.

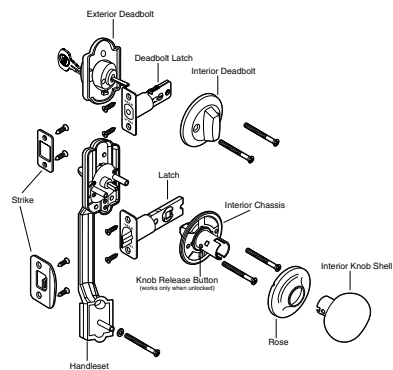

DIMENSIONS	A	B	C	D
El Dorado	2-3/8"	5-1/2"	9-11/16"	18"
McKinley	2-3/8"	5-1/2"	9-11/16"	18"
Rainier	2-3/8"	5-1/2"	9-11/16"	18"
Teton	2-3/8"	5-1/2"	9-11/16"	18"

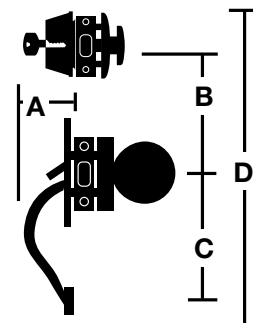



## cylinders/keying

All cylinders furnished standard 5-pin, keyed different in Yale® KW-1 keyway.

Optional cylinders:

Yale Para keyway 6-pin (specify "Para")

Schlage® C keyway 5- or 6-pin (specify "SC-1" and number of pins)

Cylinders available masterkeyed or construction/builder keyed.

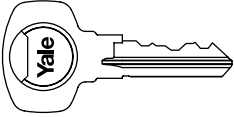
Key Blanks			
	Key Blank Description	Quantity	Model No.
	5-Pin KW1 Key Blank	50 per box	068004
	5-Pin KW1 Key - Cut	50 per box	068500
	5-Pin Schlage® Key Blank	50 per box	068008
	5-Pin Schlage® Key - cut	50 per box	068508

Cylinder Options		Model No.
<b>Schlage® 5-Pin Standard, 6-Pin Must be Specified if Needed</b>		
<b>5-Pin Compatible with F Series</b>		
Brass Cylinder & 2 Brass Keys, Tailpiece, Low Stack, Entry, 03		068401
Brass Cylinder & 2 Brass Keys, Tailpiece, Low Stack, Deadbolt, 03		068402
Brass Cylinder & 2 Brass Keys, Tailpiece, Low Stack, Entry, 26		068405
Brass Cylinder & 2 Brass Keys, Tailpiece, Low Stack, Deadbolt, 26		068406
<b>6-Pin Compatible with A Series</b>		
Brass Cylinder & 2 Brass Keys, Tailpiece, Low Stack, Entry, 03		068D01
Brass Cylinder & 2 Brass Keys, Tailpiece, High Stack, Deadbolt, 03		068D02
Brass Cylinder & 2 Brass Keys, Tailpiece, Low Stack, Entry, 26		068D05
Brass Cylinder & 2 Brass Keys, Tailpiece, High Stack, Deadbolt, 26		068D06
<b>KW1 5-Pin Standard</b>		
<b>5-Pin</b>		
Brass Cylinder & 2 Brass Keys, Tailpiece, Low Stack, Entry, 03		060003
Brass Cylinder & 2 Brass Keys, Tailpiece, Low Stack, Deadbolt, 03		060103
Brass Cylinder & 2 Brass Keys, Tailpiece, Low Stack, Entry, 26		060006
Brass Cylinder & 2 Brass Keys, Tailpiece, Low Stack, Deadbolt, 26		060106
<b>6-Pin</b>		
Brass Cylinder & 2 Brass Keys, Tailpiece, Low Stack, Entry, 03		06D013
Brass Cylinder & 2 Brass Keys, Tailpiece, High Stack, Premier Deadbolt, 03		06D103
Brass Cylinder & 2 Brass Keys, Tailpiece, Low Stack, Entry, 26		06D016
Brass Cylinder & 2 Brass Keys, Tailpiece, High Stack, Premier Deadbolt, 26		06D106

<b>For Residential Product Only Yale® PARA E1R, Y1 6-Pin Must be Specified if Needed</b>	
<b>6-Pin</b>	<b>Model No.</b>
Brass Cylinder & 2 Brass Keys,Tailpiece, High Stack, Entry Lever, 03	06Y303
Brass Cylinder & 2 Brass Keys,Tailpiece, High Stack, Entry Lever, 26	06Y306
Brass Cylinder & 2 Brass Keys,Tailpiece, High Stack, 83/820 Deadbolt, 03	06Y403
Brass Cylinder & 2 Brass Keys,Tailpiece, High Stack, 83/820 Deadbolt, 26	06Y406
Brass Cylinder & 2 Brass Keys,Tailpiece, High Stack, Premier Deadbolt, 03	06Y413
Brass Cylinder & 2 Brass Keys,Tailpiece, High Stack, Premier Deadbolt, 26	06Y416

### keying terminology

All locks will be shipped KD unless otherwise specified.

**KD:** Keyed Different

**KA:** Keyed Alike

**MK:** Master Keyed\* (A single master key operates all locks within the system.)

**BK:** Builder Key\* (Builder key operates all locksets within a system. Use of homeowner's key cancels the builder key.)

**BMK:** Builder Keyed and Master Keyed\* (Builder key and master key operates all locksets within a system. Use of tenants key cancels the builder key.)

**K-T-P:** Keyed To Pass (For apartment vestibules or laundry rooms. All tenant keys will operate.)

**GMK:** Grand Master Keyed\* (More than 1 master key system operated by a single master key.)



**BGMK:** Builder Keyed and Grand Master Keyed\* (Combination of **BK** and **GMK**.)

\*Builder and/or master keys are sent certified mail to the "Bill To" address, referencing the purchase order number and the original order number. All Master Keyed orders shipped with three (3) master keys at no extra charge. All Builder Keyed orders are shipped with ten (10) builder keys at no extra charge.



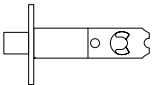
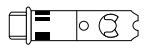
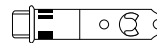
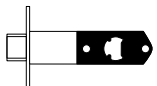

## latchbolts

### interior spring latches

	Model No.	Description	Dimensions	Corner Specs
	01415*	2-3/8" Spring Latch	1 x 2-1/4"	Square Corner
	01412*	2-3/8" Spring Latch	1 x 2-1/4"	Round Corner
	01418*	2-3/8" Spring Latch Drive-In Latch	1" Dia.	N/A
	01408*	2-3/8" Spring Latch	7/8" Dia.	N/A
	01416*	2-3/4" Spring Latch	1 x 2-1/4"	Square Corner
	01413*	2-3/4" Spring Latch	1 x 2-1/4"	Round Corner
	01419*	2-3/4" Spring Drive-In Latch	1" Dia.	N/A
	01414*	2-3/8" – 2-3/4" Adj. Spring Latch	1 x 2-1/4"	Square Corner
	01411*	2-3/8" – 2-3/4" Adj. Spring Latch	1 x 2-1/4"	Round Corner
	01417*	2-3/8" – 2-3/4" Drive-In Latch	1" Dia.	N/A

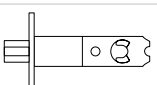
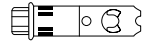
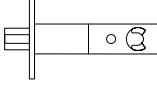
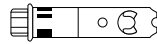
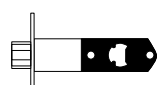

### exterior deadlocking latches

	Model No.	Description	Dimensions	Corner Specs
	01425*	2-3/8" Deadlocking Latch	1 x 2-1/4"	Square Corner
	01422*	2-3/8" Deadlocking Latch	1 x 2-1/4"	Round Corner
	01428*	2-3/8" Deadlocking Drive-In Latch	1" Dia.	N/A
	01426*	2-3/4" Deadlocking Latch	1 x 2-1/4"	Square Corner
	01423*	2-3/4" Deadlocking Latch	1 x 2-1/4"	Round Corner
	01429*	2-3/4" Deadlocking Drive-In Latch	1" Dia.	N/A
	01424*	2-3/8" – 2-3/4" Adj. Deadlocking Latch	1 x 2-1/4"	Square Corner
	01421*	2-3/8" – 2-3/4" Adj. Deadlocking Latch	1 x 2-1/4"	Round Corner
	01427*	2-3/8" – 2-3/4" Adj. Deadlocking Drive-In Latch	1" Dia.	N/A

\*Specify finish when ordering

## latchbolts

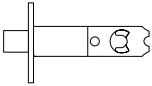
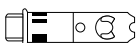
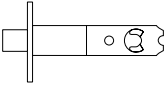
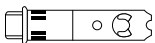
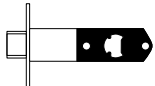
### 800 series deadbolt latches

	Model No.	Description	Dimensions	Corner Specs
	01445*	2-3/8" Deadbolt Latch	1 x 2-1/4"	Square Corner
	01442*	2-3/8" Deadbolt Latch	1 x 2-1/4"	Round Corner
	01448*	2-3/8" Deadbolt Drive-In Latch	1" Dia.	Round Face
	01446*	2-3/4" Deadbolt Latch	1 x 2-1/4"	Square Corner
	01443*	2-3/4" Deadbolt Latch	1 x 2-1/4"	Round Corner
	01449*	2-3/4" Deadbolt Drive-In Latch	1" Dia.	Round Face
	01444*	2-3/8" – 2-3/4" Adj. Deadbolt Latch	1 x 2-1/4"	Square Corner
	01441*	2-3/8" – 2-3/4" Adj. Deadbolt Latch	1 x 2-1/4"	Round Corner
	01447*	2-3/8" – 2-3/4" Adj. Deadbolt Drive-In Latch	1" Dia.	Round Face

\*Specify finish when ordering

### handleset latches – interior split-hub spring latches

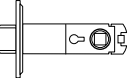
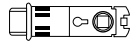
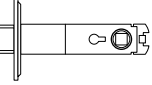
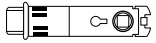
	Model No.	Description	Dimensions	Corner Specs
	01804*	2-3/8" Spring Latch	1 x 2-1/4"	Square Corner
	01802*	2-3/8" Spring Latch	1 x 2-1/4"	Round Corner
	01803*	2-3/8" Spring Drive-In Latch	1" Dia.	N/A
	01808*	2-3/4" Spring Latch	N/A	Square Corner
	01806*	2-3/4" Spring Latch	1 x 2-1/4"	Round Corner
	01807*	2-3/4" Spring Drive-In Latch	1" Dia.	N/A

\*Specify finish when ordering

# strikes

## lockset strikes

Model No.	Item	Dimension	Corner Specs
02001*	Standard Full Lip Strike/SC	1-3/4" x 2-1/4"	Square Corner
02000*	Standard Full Lip Strike/RC	1-3/4" x 2-1/4"	Round Corner
02020*	T-Strike	1-1/8" x 2-3/4"	Square Corner
02030*	ANSI 4-7/8"	1-1/4" x 4-7/8"	Square Corner

\* Specify finish when ordering

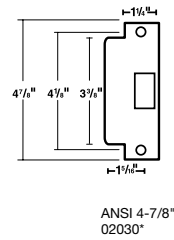
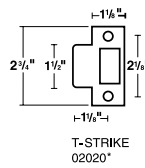
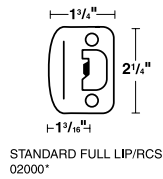
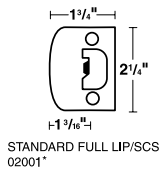

## deadbolt strikes

Model No.	Item	Corner Specs
02082*	Standard Deadbolt Strike/SC	Square Corner
02080*	Standard Deadbolt Strike/RC	Round Corner
02081*	Security Strike 3-5/8"	Round Corner
02083*	Security Strike 3-5/8"	Square Corner
02091*	Full Lip Security Strike	Round Corner
02085*	Full Lip Deadbolt Strike	Square Corner
02084*	Full Lip Deadbolt Strike	Round Corner
02086*	Universal Deadbolt Strike	Square Corner
02071*	Canadian Deadbolt Strike	Round Corner
02073*	Canadian Deadbolt Strike	Square Corner
026002	White Plastic Dust Box 1" x 2-3/4" Deadbolt (For Universal Strike)	

\* Specify finish when ordering

