

ELECTRIC STRIKE DIMENSIONS

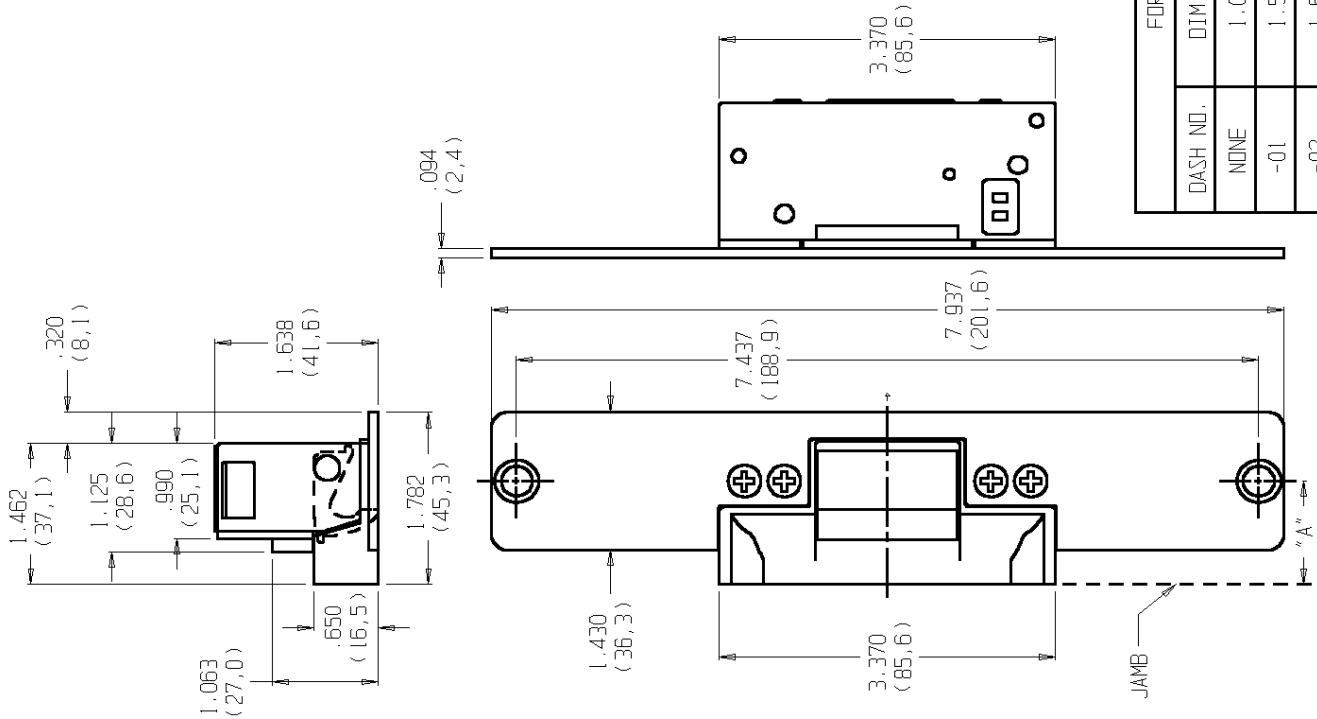

STANDARD UNIT FITS DIM. "A"
UP TO 1.06" (SEE DASH NO.)

JAMB PREPARATION

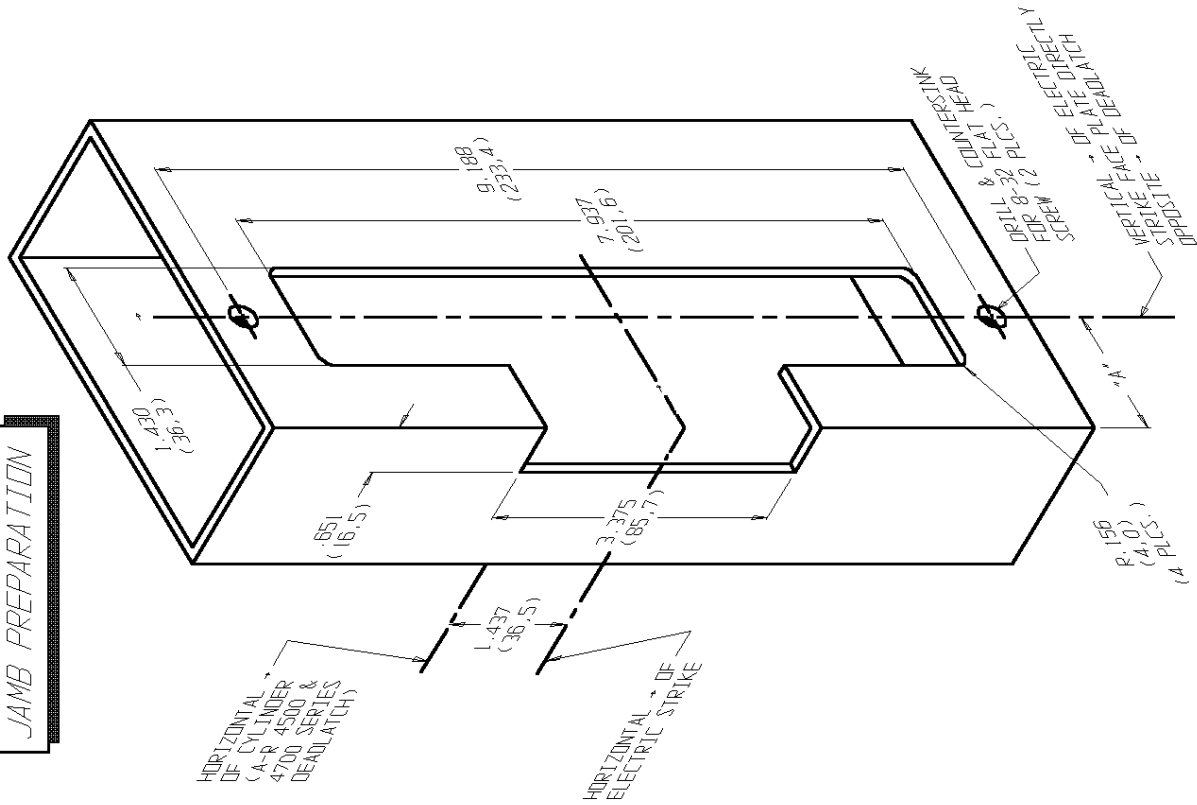

FOR EXTENDED LIP: (DIM "A" DOOR → TO JAMB EDGE)

DASH NO.	DIM "A"	DASH NO.	DIM "A"	DASH NO.	DIM "A"
NONE	1.06	-05	2.00	-10	2.63
-01	1.50	-06	2.13	-11	2.75
-02	1.63	-07	2.25	-12	2.88
-03	1.75	-08	2.38	-13	3.00
-04	1.88	-09	2.50		

ADAMS RITE MANUFACTURING COMPANY
POMONA, CA. 91767

7110 ELECTRIC STRIKE
FOR ALUMINUM JAMB WITH
A-R 4500/4700 DEADLATCHES

REF. INSTRUCTION SHEET NO.:
80-0180-379

TEMPLATE NO.:
52035-0

DATE:
09-13-95