



345 Bayview Avenue
Amityville, New York 11701
For Sales and Repairs 1-800-ALA-LOCK
For Technical Service 1-800-645-9440
or visit us at <http://tech.napcosecurity.com/>
(Note: Technical Service is for security professionals only)
Publicly traded on NASDAQ Symbol: NSSC
© ALARM LOCK 2016

ELECTRONIC PANIC LOCKS

INSTALLATION AND OPERATION INSTRUCTIONS

PADDLE ARM MODELS 250 / 260

PUSH BAR MODELS 700 / 710

WATERPROOF MODELS 250WP / 700WP / 710WP

WI1601 04/16

GENERAL DESCRIPTION

Models 250, 260, 700 and 710 are non-handed electronic exit door locking systems. The specific models are:

- **250**..... Clapper Plate Model
- **250WP**... Clapper Plate Waterproof
- **260**..... Clapper Plate Retriggerable
- **700**..... Channel Push Bar
- **700WP**... Channel Push Bar Waterproof
- **710**..... Channel Push Bar Retriggerable
- **710WP**... Channel Push Bar Retriggerable Waterproof

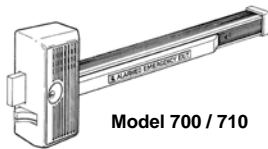
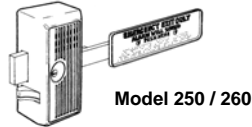

Maximum Current:

Idle with bolt extended: 22µa @ 9VDC input
Idle with bolt retracted:..... 18µa @ 9VDC input
Alarm:..... 50mA

Sound Pressure Level:..... 99dB (c-weighted @ 10ft.) +/- 3dB

Dimensions (WxHxD):..... Models 700-710: 33 x 8½ x 3¼ in.
..... Models 250-260: 18 x 8½ x 3¼ in.

Shipping Weight: Models 700-710: 12 lbs. approx.
..... Models 250-260: 9 lbs. approx.

Temperature Range:..... -20° to +140°F (-29° to 60°C)

Chassis Construction:..... Die cast zinc and aluminum

Finish:..... US28 Aluminum or US312 Duranodic Powder Coat

Arming is accomplished by actuating the deadbolt using a rim cylinder (not included). When armed, depressing the paddle or push bar will release the deadbolt and sound an immediate alarm.

Several other options are available. Jumpers inside the unit allow for either a "Continuous Alarm" or a two-minute "Auto-alarm Shutdown".

- **"Continuous Alarm" mode:** When triggered, the alarm remains sounding until deactivated when relocked with the key.
- **"Auto-Alarm Shutdown" mode:** When triggered, the alarm remains sounding for two minutes, the lock then checks if the door is closed. If the lock detects the door is closed, the sounder will turn off; if the lock detects the door is still open, the sounder remains on for another two minutes and the process repeats by re-checking the door status every two minutes.

After the initial two minute alarm and automatic shutdown, **"Retriggerable"** models allow the alarm to reactivate if the door is opened again. The lock remains retriggerable until the door is relocked with the key. **Note:** Whenever an alarm is caused by opening the door, and the door is left open, the two minute alarm shutdown will be inhibited.

SPECIFICATIONS

All specifications are rated at 72°F (22°C).

Power Source: 9VDC alkaline battery

Battery Life:

For non-waterproof models: 4 years standby in armed mode; 600 two-minute alarm sequences. ("Auto-Alarm Shutdown" mode), 20 hours continuous alarm

For waterproof models: 9VDC long-life sealed alkaline battery pack (part #S6173). Increased standby times, alarm sequence cycles and continuous alarm duration (compared with non-waterproof models).

FEATURES

- Non-handed
- Deadbolt with hardened steel insert
- Deadlatch for easy access from inside without alarm
- Deadbolt can be operated by outside key (optional)
- For single or double doors
- Loud dual-piezo horn
- Continuous or two-minute alarm shutdown
- Disarming beep sounds when bolt retracted with key
- Low battery beep when battery needs to be replaced
- Retriggerable models: Automatic re-arming after two minute shutdown

TABLE OF CONTENTS

GENERAL DESCRIPTION	1
SPECIFICATIONS	1
FEATURES	1
OPTIONAL EQUIPMENT	2
PRECAUTIONS	2
SINGLE DOOR INSTALLATIONS	3
DOUBLE DOOR INSTALLATIONS	7
OPERATING INSTRUCTIONS	11
OPERATIONAL TESTING	11
LOW BATTERY DETECTION	11
DOGGING OPERATION	11
SCREW CHART	12-13
DETAIL ASSEMBLY OF 700 & 710 SERIES	14
DETAIL ASSEMBLY OF 250 & 260 SERIES	15
LIMITED WARRANTY	16

OPTIONAL EQUIPMENT

- **Outside Access Door Pull Model 707** - For access from building exteriors. Installed on the outside of the door and linked to the lock. After deadbolt is retracted by outside key, a slight pull will release the deadlatch and open door. Cast aluminum, 8" x 1.5".
- **Double Door Keeper Model 732** - Applied to the surface of the inactive leaf of a pair of doors. Plated case aluminum 7/8" x 6"
- **Single Door Keeper Model 730** - Supplied for single doors or pairs of doors with mullions.
- **Double-Door Strike Model 735** - Alarm Lock double-door strike Model 735 is specifically designed for the Model 715 Series Delayed Egress Panic Lock
- **Finish Back Plate Model 767** - Required to conceal the open back of the lock body when mounted on a glass door. Stainless steel 4.5" x 8.5".
- **Cylinder Finger Pull Model 711** - An inexpensive door pull for use when outside key only access is required.
- **Armored Door Loop Model 271** - For use with electrified locks. An easy means for bringing electric current from the hinge side of a door frame to the door. 18" flexible armored cable. End brackets are deep drawn anodized aluminum to conceal wire connections.
- **Double Door Holder Model 44** - The double door holder secures the inactive door to the door frame while the active door is closed. Releasing the active door automatically allows both doors to swing freely. Reversible, right or left hand doors. Cast aluminum 8.5" long, 3" wide and 2.5" High.
- **Rim Cylinder Model CER-OKC** - Used to lock and unlock all of our exit and panic alarm locks from outside. Includes two keys for outside key control (KA or KD).
- **Thumb Turn Model THT** - Used instead of cylinder and keys to retract and project the deadbolt from inside.
- **Battery Eliminator Model AC-9** - Provides constant regulated 9VDC power for models 250 and 260. It is simple to install and maintenance free. 117 VAC to 9VDC. The AC-9 conserves the battery and automatically takes over as the power source in the event of a power failure or intentional power cutoff.
- **Battery Eliminator Model PP100** - Provides unregulated 6-9VDC @ 0-300mA, replacing all power normally supplied by the device's internal batteries, allowing the internal batteries to be used exclusively for battery backup if AC is lost (automatic switchover to battery upon AC input failure). 9 volt adapter harness and 6' (1.8m) armored cable supplied. Input voltage 105-125VAC @ 60Hz; Input power 10VA max.

PRECAUTIONS

- Do not connect the battery until the installation is complete.
- The Lock Assembly circuit board is fragile. Exercise care while the **Lock Cover** is removed.
- When making electrical connections to the Lock Assembly, be sure that the wires do not interfere with the mechanical operation of the lock mechanism.
- If the sounder cable is removed from the Lock Assembly circuit board, observe polarity shown on the label when installing.

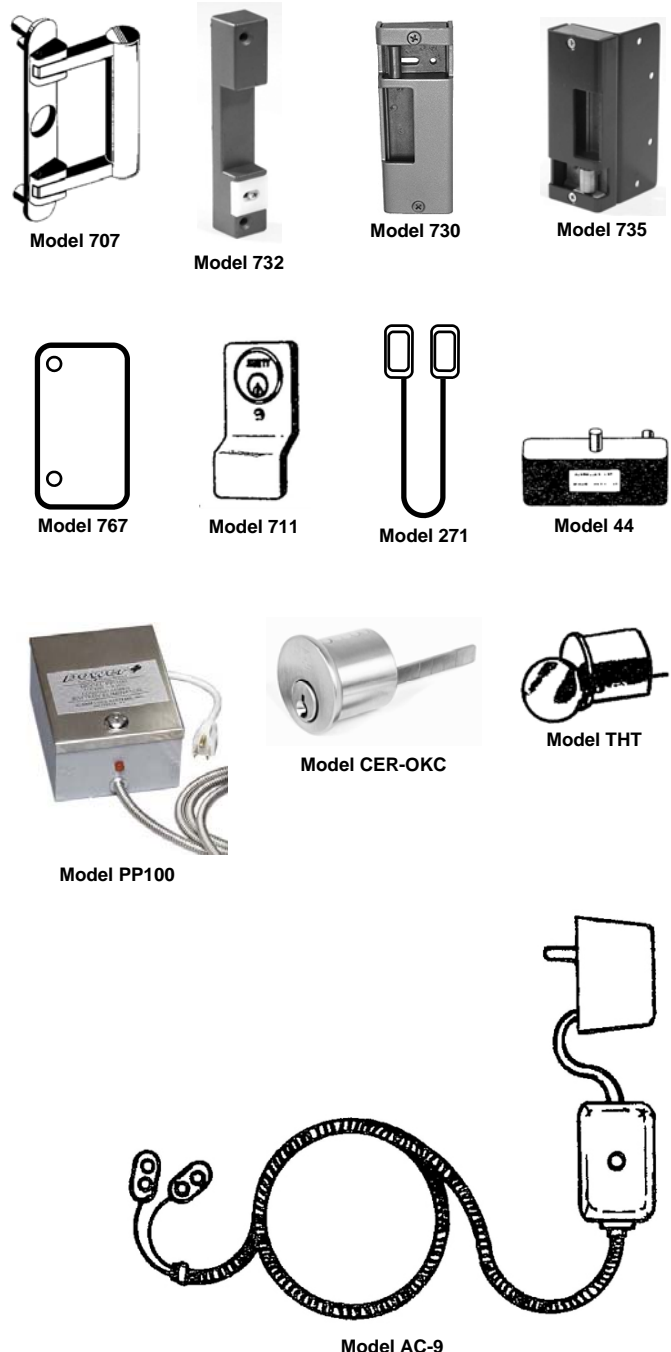

Single Door Installations

SINGLE DOOR INSTALLATIONS

(For double door installations, turn page 6).

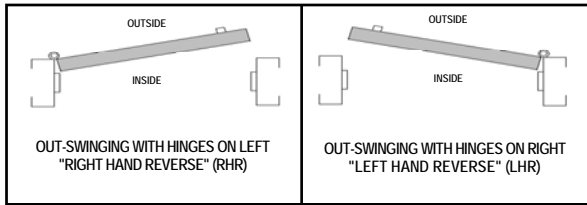

Fig. 1: Cross Section Top View -- Door Hand.

See Fig. 1 to determine the door handing type for your installation. All models are non-handed and can be used for single or double-door installations. For double door installations, skip this section and turn to page 7. The instructions that follow illustrate a typical installation of a model 700/710 to a single "right-hand reverse" door.

1. POSITION THE TEMPLATE

The template positions the lock body relative to the door jamb. Be sure to make an allowance for the gap between the door and the doorjamb (**Note: This gap cannot exceed 5/8" or the latchbolt will not catch within the Keeper Assembly and the door will not lock.**)

Close the door and carefully tape the template to the inside surface of the door and the jamb so that the hole for the rim cylinder is about 38" above the floor. (Note special instructions for mounting onto a narrow-stile glass door). See Fig. 2.

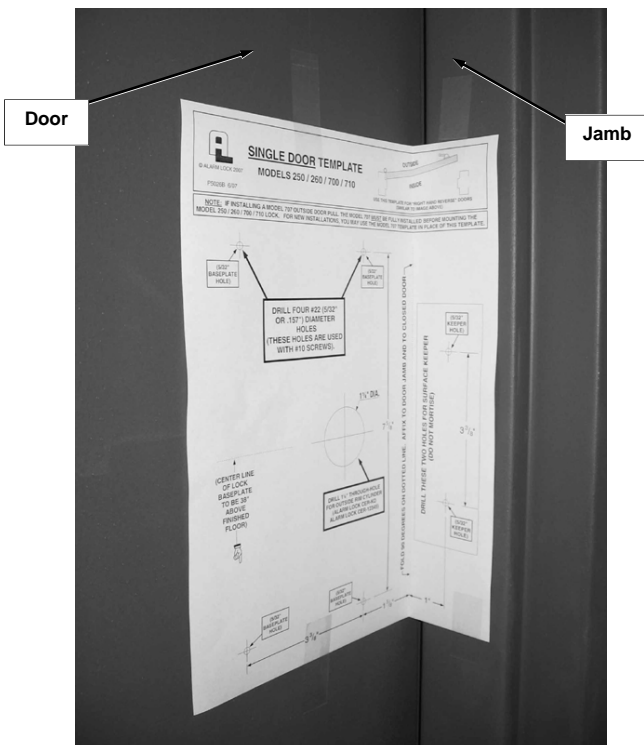

Fig. 2: With door closed, template folded and taped to inside surface of the door and door jamb 38" above floor from mark indicated on template.

2. MARK AND DRILL HOLES

Compare holes referenced on the template (P5026) with holes described in the text below. Reposition the template as often as needed until it is placed correctly. Drill slowly and STRAIGHT through the door.

- Mark six (6) .157" (5/32") diameter holes, four (4) for the **Lock Base Plate** and two (2) (of the four shown on the template) for the **Keeper Base Plate** (P1157).

Note: For mounting onto a narrow-stile glass door, drill only two holes for the **Lock Base Plate**, along the jamb edge.

- IF OUTSIDE CYLINDER (MODEL CER-OKC) IS USED:** Mark the center of the 1/4" diameter hole.
- IF OUTSIDE PULL (MODEL 707) IS USED:** Use the door pull template (W11627). Mark the center of the four 1/4" diameter holes. Then proceed as follows:

For solid wood doors:

- Drill 1/4" diameter through-hole.
- From outside of door, use through-hole drilled in previous step to drill a 5/8" diameter hole to a depth of 1 1/4" only.

For hollow metal doors:

- Drill 1/4" diameter through-hole.
- From outside of door, use through-hole drilled in previous step to drill a 5/8" diameter hole in outer metal skin only.

3. INSTALL LOCK CYLINDER (Not supplied)

Remove the **Lock Cover**. Remove the four (4) screws securing the **Cylinder Housing** (P1145) to the **Lock Base Plate** assembly as shown in Fig. 3.

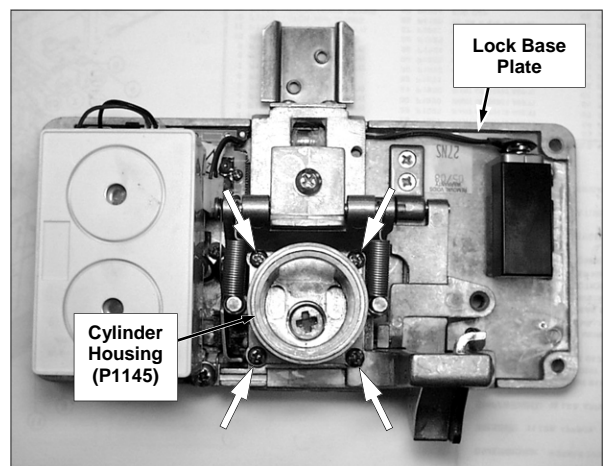

Fig. 3: The **Lock Base Plate** assembly. The lock cylinder is not supplied as shown in this image. Remove 4 screws securing the **Cylinder Housing** (4 arrows).

Install lock cylinder (CER) with the keyway horizontal, facing the front of the lock as shown in Fig. 4 (below).

Single Door Installations (cont'd)

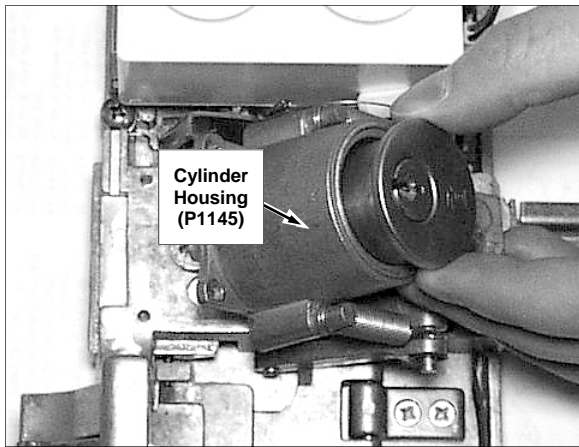

Fig. 4: Install lock cylinder (CER) with the keyway horizontal, facing the front of the lock (nine o'clock position) as shown.

Secure the lock cylinder to the **Cylinder Housing** (P1145) base with the two screws supplied with the lock cylinder (shown in Fig. 5). If needed, cut the cylinder **Tailpiece** 3/8" beyond the **Cylinder Housing** base. Replace the **Cylinder Housing** by guiding the **Tailpiece** into the **Cam Crosshole**, then re-secure the **Cylinder Housing** to the **Lock Base Plate** assembly with the four screws removed in step 3.

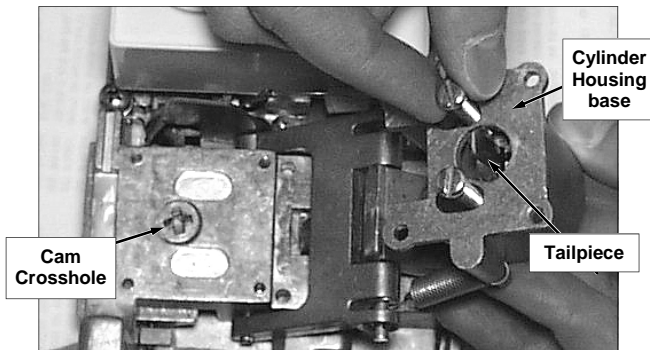

Fig. 5: Secure the lock cylinder to the **Cylinder Housing** base with two screws as shown. The **Tailpiece** must extend beyond the base of the **Cylinder Housing** and must fit into the **Cam Crosshole**.

4. TEST THE DEADBOLT

Use the key to test for proper operation of the deadbolt. Turn the key counter-clockwise to project the deadbolt and turn the key clockwise 360° to retract the deadbolt. The key should be able to be withdrawn from the lock cylinder in either the fully projected ("locked") or fully retracted ("unlocked") position of the deadbolt.

If the key cannot be withdrawn, the lock cylinder and the Cam are mis-aligned. Remove the four (4) screws securing the **Cylinder Housing** to the **Lock Base Plate** assembly as shown in Fig. 3, turn the Cam a quarter turn clockwise, then re-secure the **Cylinder Housing**. Re-test the deadbolt.

5. ATTACH PUSH BAR ASSY (Models 700 / 710 only)

See Fig. 6. Use the **1/8" Hex Wrench** (supplied) to remove the **Hex Screw** (SC636), the small **Lock Washer** (WA136) and the **Stiffening Washer** (WA201) from the **Clapper Arm-Hinge Bkt** (P5022).

Place the **Push Bar Assy** on top of the **Clapper Arm-Hinge Bkt**, and place the **Stiffening Washer** on top of the **Push Bar Assy** as shown. Secure with the small **Lock Washer** and **Hex Screw** as shown in Fig. 6.

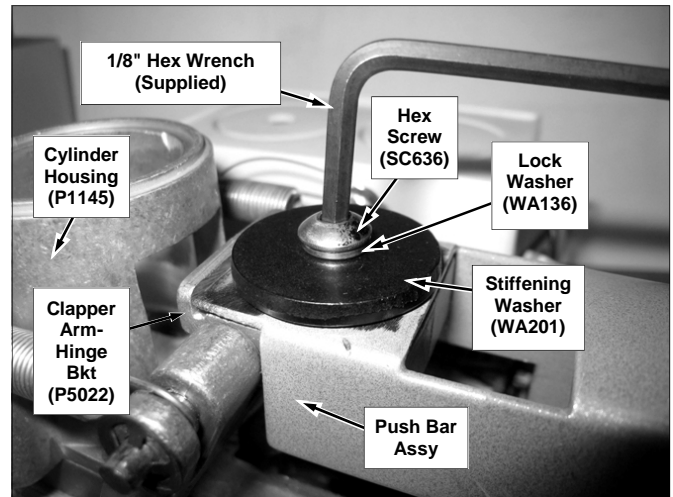

Fig. 6: Place the **Push Bar Assy** on top of the **Clapper Arm-Hinge Bkt**, and place the **Stiffening Washer** on top of the **Push Bar Assy**. Secure with the small **Lock Washer** and **Hex Screw** as shown.

See Fig. 7. Carefully turn the **Lock Base Plate** assembly over, and secure the **Push Bar Assy** to the **Channel/Retaining Bracket** (P5017) using two #10-24 x 1/2" Phillips flat head undercut zinc plated machine screws (P5460).

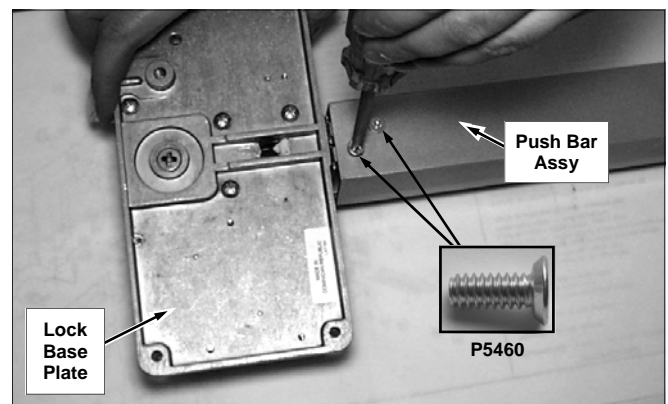



Fig. 7: secure the **Push Bar Assy** to the **Channel/Retaining Bracket** (P5017) using two #10-24 x 1/2" Phillips flat head undercut zinc plated machine screws (P5460).

6. SECURE LOCK BASE PLATE TO DOOR

Align the **Lock Base Plate** (with its attached **Push Bar Assy**) with the holes drilled in step 2. Use the fol-



Single Door Installations (cont'd)

lowing screws to secure the **Lock Base Plate** to the door (Do NOT tighten fully at this time):

<p>For WOOD DOORS #10 x 1-3/4" Phillips Pan Head, Zinc Plated</p> 
<p>For Hollow METAL DOORS #10-24 x 1" Phillips Pan Head, Stainless Steel, Type F Thread Cutting</p> 

door and use the following screws to secure the **Retaining Bracket** to the door.

Note: If the **Push Bar Assy** is too long for the door, cut the end of the **Channel Insert** (P5046) and **Base Channel** (P5011) to the proper length and remove burrs from the edges.

<p>For WOOD DOORS #10 x 3/4" Phillips Pan head, Zinc Plated</p> 
<p>For Hollow METAL DOORS #10-24 x 5/8" Phillips Pan Head, Stainless Steel, Type F Thread Cutting</p> 

Separate the **End Cap** (P5034) from its **Retaining Bracket** (P5045).

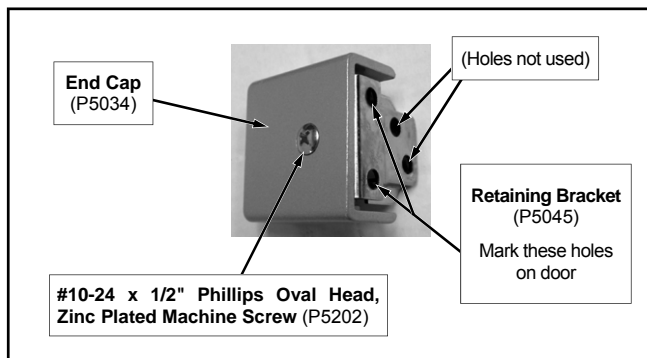

Fig. 8: The **End Cap** is secured to the **Retaining Bracket** at the factory.

Mount the **End Cap** to the **Retaining Bracket** and secure with a **#10-24 x 1/2" Phillips Oval Head, Zinc Plated Machine Screw** (P5202) provided (see Fig. 8 and Fig. 10).

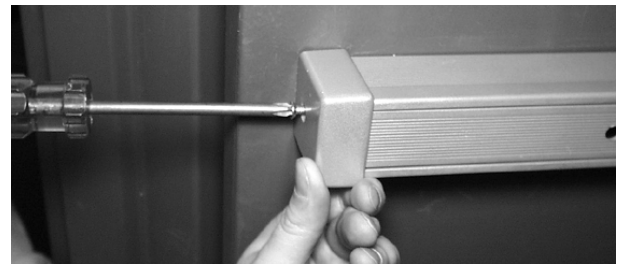

Fig. 10: Mount the **End Cap**.

7. SECURE PUSH BAR ASSY TO DOOR

Hold the end of the **Push Bar Assy** horizontally against the door using a level. Slide the **Retaining Bracket** (P5045) into the end of the **Push Bar Assy**. Using the **Retaining Bracket** as a template, mark two holes on the door as shown in Fig. 8 and Fig. 9. Be sure to mark the correct holes.

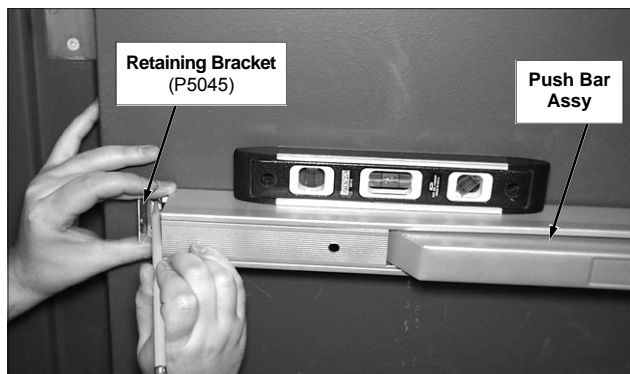



Fig. 9: Using the **Retaining Bracket** as a template, mark two holes on the door. Use a level to ensure the **Push Bar Assy** is horizontal.

8. TIGHTEN THE LOCK BASE PLATE

Fully tighten and secure the **Lock Base Plate** to the door. Do NOT install the **Lock Cover** (P5014) at this time.

9. SINGLE DOOR KEEPER INSTALLATION

Before drilling holes for the single door **Keeper Base** (P1157) in the surface of the doorframe, select the correct screws as follows:

<p>For WOOD Doorframes #10 x 1-1/2" Flat head, Phillips Zinc Plated (four count)</p> 
<p>For Hollow METAL Doorframes #10-24 x 5/8" Machine Screw, Phillips Flat Head, Type F Thread Cutting Stainless Steel (four count)</p> 

Drill two .157" (5/32") diameter mounting holes into the

Single Door Installations (cont'd)

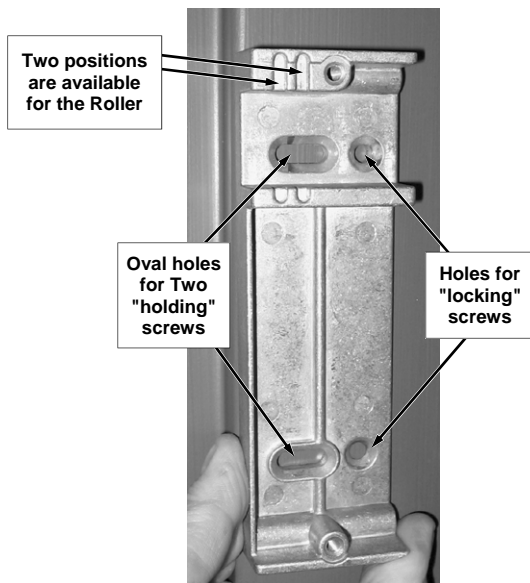

Fig. 11: Install the **Keeper Base** (P1157). Do not drill the holes for the "locking" screws until the **Keeper Base** is adjusted correctly.

Keeper Overview

In general, the **Keeper Base** (P1157) should be installed as close to the edge of the door jamb as possible, in keeping with the measurements on the template, to hold the door tightly latched, thus *minimizing door rattle*.

To allow side-to-side ("forward to back") adjustment of the **Keeper Base**, as shown in Fig. 11, two "holding screws" are to be inserted loosely into the **Keeper Base** oval holes (as shown on the template).

Important: Only *after* the **Keeper Base** position is finalized should the "locking" screw round holes be drilled.

Adjustable "Roller"

In addition to the side-to-side ("forward to back") adjustability provided by the oval "holding screw" holes, two positions are available for the **Roller** (P1171 and P1937).

The single door Keeper is shipped from the factory with its **Keeper Cover** (P0248) installed, holding the installed **Roller** in place. When the **Keeper Cover** is removed, notice the **Roller** (and its **Pin**) have two available positions, "forward" (closer to the closing latch) and "rear" (further from the closing latch). The standard position is "forward", and initial adjustments should be made with the **Roller** installed in this position.

Installation

- a. Close the door and verify the correct height position of the **Keeper Base** with respect to the latch. As shown on the template, drill two .157" (5/32") diameter holes for the two "holding screws" (oval holes).

- b. Remove the **Keeper Cover** from the **Keeper Base** by unscrewing its two screws.
- c. With the **Keeper Base** positioned against the door jamb, insert the appropriate screws into the oval holes of the **Keeper Base**. To allow side-to-side ("forward to back") adjustment of the **Keeper Base**, do NOT tighten these screws yet.
- d. Close the door, project the deadbolt and adjust the **Keeper Base** so that the door is tightly latched. Retract the deadbolt, hold the **Keeper Base**, release the latch and open the door. Tighten the two "holding" screws. If you cannot get the door to be held tightly latched against the **Keeper Base**, it might be necessary to move the **Roller** into its "rear" position (further from the closing latch).

*Recheck the position of the **Keeper Base** as many times as necessary to ensure the door is tightly latched. Ensure the deadbolt, when extended, floats within the rectangular deadbolt hole created when the **Keeper Cover** is installed into the **Keeper Base**.*

As stated earlier, do NOT drill the "locking" screw (round holes) in the **Keeper Base** until the **Keeper Base** position is finalized.

- e. When the **Keeper Base** position is finalized, drill two .157" (5/32") diameter holes, as shown on template, for the "locking" screws. Insert the appropriate screws into the round "locking" holes of the **Keeper Base**, and tighten the screws to securely fasten the keeper to the door jamb.
- f. Install the **Keeper Cover** on the **Keeper Base** by screwing in its two screws (Part # SC413; #8-32 x 5/8" Machine Screw, Phillips Flat Head, Zinc Plated).

10. FINALIZING THE INSTALLATION

Ensure the 9-volt battery is installed and its plug is inserted into the lock **Sub-Ass'y PCB** (printed circuit board). Secure the **Lock Cover** with four #6-32 x 1/4" Phillips Truss Head, Zinc Plated screws.

Secure the Lock Cover

#6-32 x 1/4" Phillips Truss Head, Zinc Plated (four count)



Double Door Installations

DOUBLE DOOR INSTALLATIONS

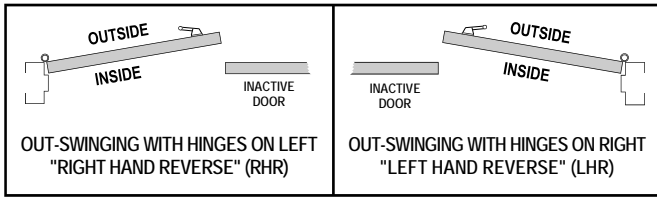

Fig. A: Cross Section Top View -- Door Hand.

See Fig. A to determine the door handing type for your installation. All models are non-handed and can be used for single or double-door installations. For single door installations, stop here and turn to page 3. The instructions that follow illustrate a typical installation of a model 700 / 710 to a "right-hand reverse" double door.

1. POSITION THE TEMPLATE

The template positions the lock body relative to the inactive door. (**Note:** *The gap between the active door and inactive door cannot exceed 5/8" or the latchbolt will not catch within the Keeper Assembly and the door will not lock.*)

With the door closed, carefully tape the template to the inside surface of the active and inactive doors so that the hole for the rim cylinder is about 38" above the floor. Place the dotted line on the template on the edge of the active door. See Fig. B.

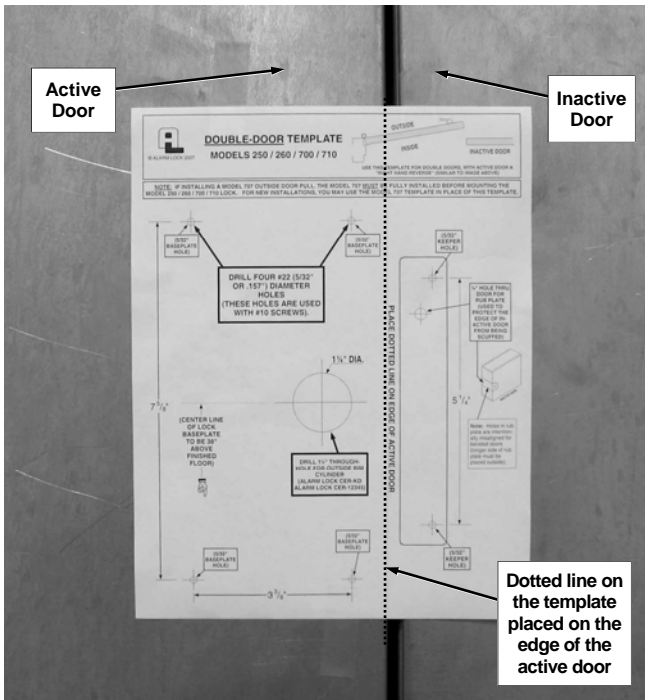

Fig. B: With door closed, tape the template to the inside surface of the active and inactive doors 38" above floor from the mark indicated on the template. Place the dotted line on the template on the edge of the active door.

2. MARK AND DRILL THE HOLES

Compare holes referenced on the template (P5026) with holes described in the text below. Drill slowly and STRAIGHT through the door. Reposition the template as often as needed until it is placed correctly.

- Mark six (6) .157" (5/32") diameter holes, four (4) for the Lock Base Plate and two (2) (of the three shown on template) for the Keeper Assembly.

Note: For mounting onto a narrow-stile glass door, drill only two holes for the Lock Base Plate, along the jamb edge.

- IF OUTSIDE CYLINDER (MODEL CER-OKC) IS USED:** Mark the center of the 1 1/4" diameter hole.
- IF OUTSIDE PULL (MODEL 707) IS USED:** Use the door pull template (P3191). Mark the center of the four (4) 1/4" diameter holes. Then proceed as follows:

For solid wood doors:

- Drill 1/4" diameter through-hole.
- From outside of door, use through-hole drilled in previous step to drill a 5/8" diameter hole to a depth of 1 1/4" only.

For hollow metal doors:

- Drill 1/4" diameter through-hole.
- From outside of door, use through-hole drilled in previous step to drill a 5/8" diameter hole in outer metal skin only.

3. INSTALL LOCK CYLINDER (Not supplied)

Remove the **Lock Cover**. Remove the four (4) screws securing the **Cylinder Housing (P1145)** to the **Lock Base Plate** assembly as shown in Fig. C.

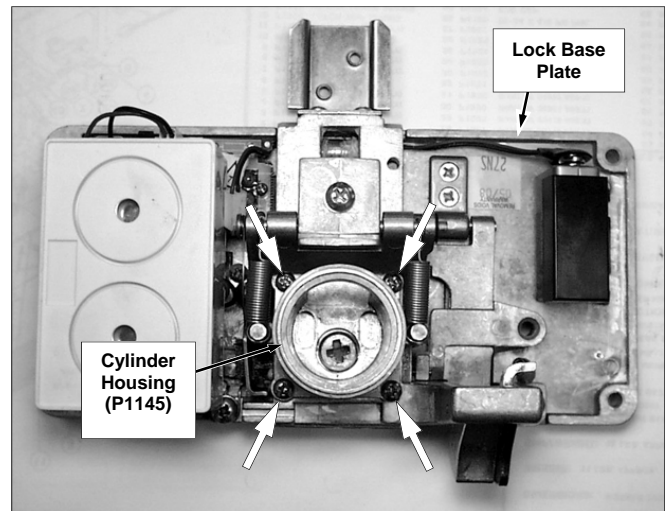

Fig. C: The Lock Base Plate assembly. The lock cylinder is not supplied as shown in this image. Remove 4 screws securing the Cylinder Housing (4 arrows).

Install lock cylinder (CER) with the keyway horizontal, facing the front of the lock as shown in Fig. D (below).

Double Door Installations (cont'd)

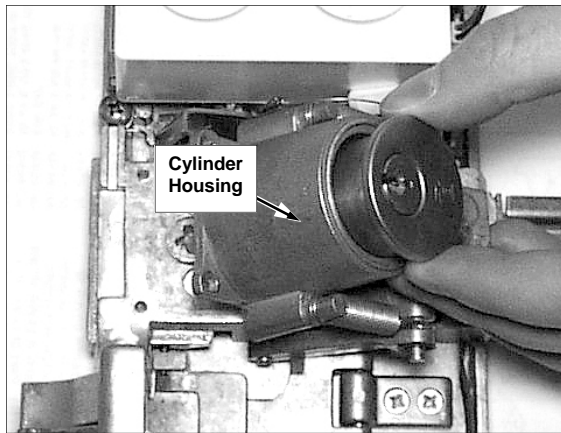

Fig. D: Install lock cylinder (CER) with the keyway horizontal, facing the front of the lock (nine o'clock position) as shown.

Secure the lock cylinder to the **Cylinder Housing** (P1145) base with two screws (supplied with the lock cylinder) as shown in Fig. E. If needed, cut the cylinder **Tailpiece** 3/8" beyond the **Cylinder Housing** base. Replace the **Cylinder Housing** by guiding the **Tailpiece** into the **Cam Crosshole**, then re-secure the **Cylinder Housing** to the **Lock Base Plate** assembly with the four (4) screws removed in step 3.

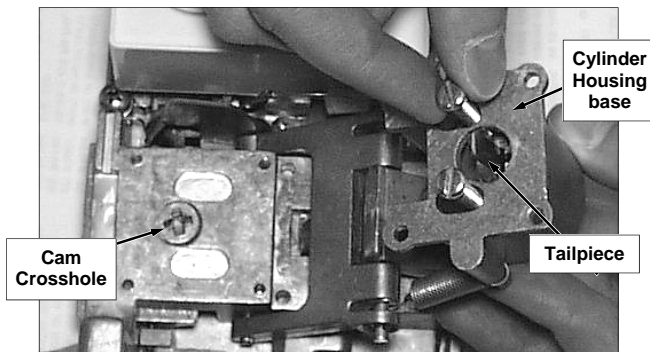

Fig. E: Secure the lock cylinder to the **Cylinder Housing** base with two screws as shown. The **Tailpiece** must extend beyond the base of the **Cylinder Housing** and must fit into the **Cam Crosshole**.

4. TEST THE DEADBOLT

Use the key to test for proper operation of the deadbolt. Turn the key counter-clockwise to project the deadbolt and turn the key clockwise 360° to retract the deadbolt. The key should be able to be withdrawn from the lock cylinder in either the fully projected ("locked") or fully retracted ("unlocked") position of the deadbolt.

If the key cannot be withdrawn, the lock cylinder and the Cam are mis-aligned. Remove the four (4) screws securing the **Cylinder Housing** (P1145) to the **Lock Base Plate** assembly as shown in Fig. C, turn the Cam a quarter turn clockwise, then re-secure the **Cylinder Housing**. Re-test the deadbolt.

5. ATTACH PUSH BAR ASSY (Models 700 / 710 only)

See Fig. F. Use the **1/8" Hex Wrench** (supplied) to remove the **Hex Screw** (SC636), the small **Lock Washer** (WA136) and the **Stiffening Washer** (WA201) from the **Clapper Arm-Hinge Bkt** (P5022).

Place the **Push Bar Assy** on top of the **Clapper Arm-Hinge Bkt**, and place the **Stiffening Washer** on top of the **Push Bar Assy** as shown. Secure with the small **Lock Washer** and **Hex Screw** as shown in Fig. F.

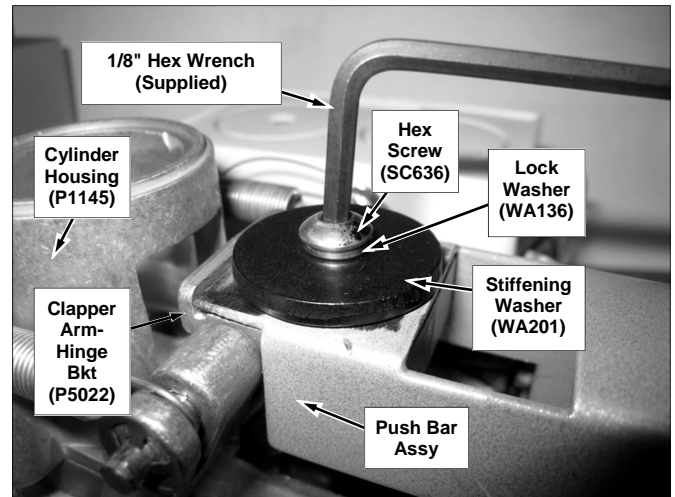

Fig. F: Place the **Push Bar Assy** on top of the **Clapper Arm-Hinge Bkt**, and place the **Stiffening Washer** on top of the **Push Bar Assy**. Secure with the small **Lock Washer** and **Hex Screw** as shown.

See Fig. G. Carefully turn the **Lock Base Plate** assembly over, and secure the **Push Bar Assy** to the **Channel/Retaining Bracket** (P5017) using two #10-24 x 1/2" Phillips flat head undercut zinc plated machine screws (P5460).

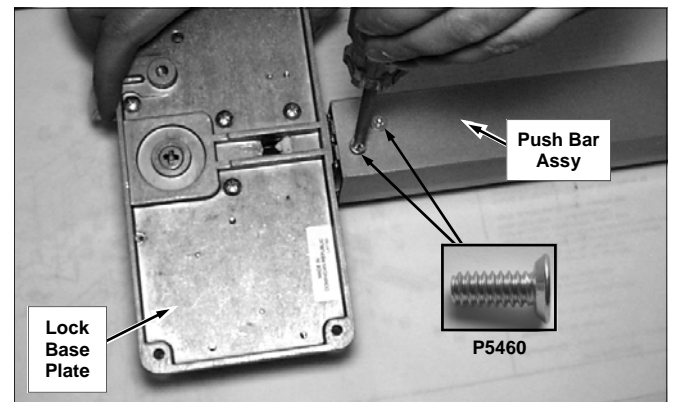

Fig. G: secure the **Push Bar Assy** to the **Channel/Retaining Bracket** (P5017) using two #10-24 x 1/2" Phillips flat head undercut zinc plated machine screws (P5460).

6. SECURE LOCK BASE PLATE TO DOOR

Align the **Lock Base Plate** (with its attached **Push Bar Assy**) with the holes drilled in step 2. Use the following screws to secure the **Lock Base Plate** to the door (Do NOT tighten fully at this time):

Double Door Installations (cont'd)

For WOOD DOORS

#10 x 1-3/4" Phillips Pan Head, Zinc Plated



For Hollow METAL DOORS

#10-24 x 1" Phillips Pan Head, Stainless Steel, Type F Thread Cutting



Note: If the **Push Bar Assy** is too long for the door, cut the end of the **Channel Insert** (P5046) and **Base Channel** (P5011) to the proper length and remove burrs from the edges.

For WOOD DOORS

#10 x 3/4" Phillips Pan head, Zinc Plated



For Hollow METAL DOORS

#10-24 x 5/8" Phillips Pan Head, Stainless Steel, Type F Thread Cutting



Separate the **End Cap** (P5034) from its **Retaining Bracket** (P5045).

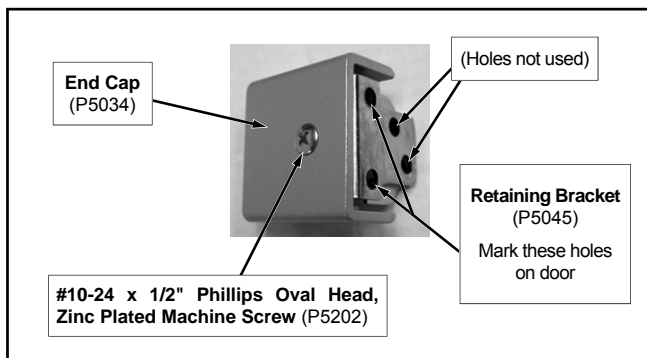

Fig. H: The **End Cap** is secured to the **Retaining Bracket** at the factory.

Mount the **End Cap** to the **Retaining Bracket** and secure with a **#10-24 x 1/2" Phillips Oval Head, Zinc Plated Machine Screw** (P5202) provided (see Fig. H and Fig. J).

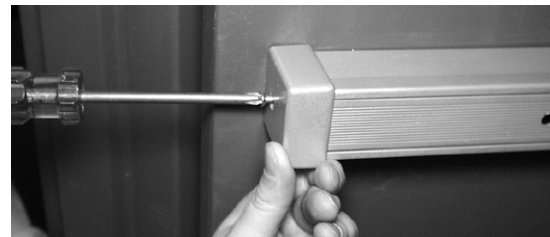

Fig. J: Mount the **End Cap**.

7. SECURE PUSH BAR ASSY TO DOOR

Hold the end of the **Push Bar Assy** horizontally against the door using a level. Slide the **Retaining Bracket** (P5045) into the end of the **Push Bar Assy**. Using the **Retaining Bracket** as a template, mark two holes on the door as shown in Fig. H and Fig. I. Be sure to mark the correct holes.

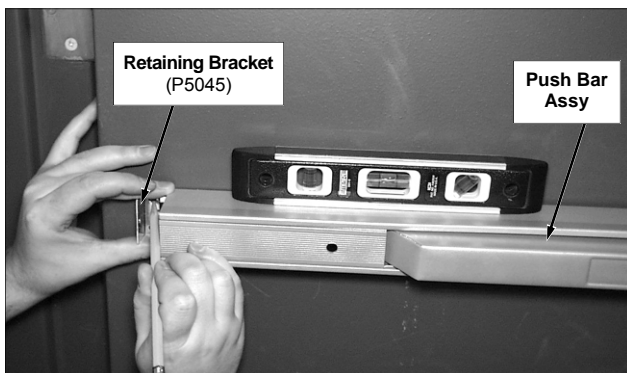

Fig. I: Using the **Retaining Bracket** as a template, mark two holes on the door. Use a level to ensure the **Push Bar Assy** is horizontal.

Drill two .157" (5/32") diameter mounting holes into the door and use the following screws to secure the **Retaining Bracket** to the door.

8. TIGHTEN THE LOCK BASE PLATE

Fully tighten and secure the **Lock Base Plate** to the door. Do NOT install the **Lock Cover** (P5014) at this time.

9. INSTALL THE RUB PLATE

Examine the template and physical parts

On the **Double-Door Template** (P5026), find the **5/32" Keeper Holes**; observe that these two holes are used to mark the screws that secure the **Double-Door Keeper Base** to the inactive door. The third hole on the template is used to mark the **Rub Plate** "through-hole". Notice that the **Rub Plate** through-hole on the template is, by coincidence, located directly under the screw that secures the **Black Nylon Insert** to the **Double-Door Keeper Base**. Be aware that the **Rub Plate** "through-hole" and the **Black Nylon Insert** screw hole are used for two separate purposes:

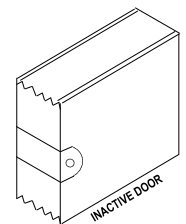

Fig. K: Rub Plate.

- The **Rub Plate** is used to protect the edge of the inactive door from being scuffed by the latchbolt as shown in Fig. K.
- The **black nylon insert** (see Fig. L) is used to prevent the locked active door from rattling and is adjusted with the **Double-Door Keeper Base** secured and the deadbolt projected.

Double Door Installations (cont'd)

Install the Rub Plate

Install the **Rub Plate** for a 1 3/4" wide door. Note that the holes in the **Rub Plate** are intentionally misaligned (and the sides are of different lengths) in order to fit beveled doors (the longer side of the **Rub Plate** is placed outside). The **Rub Plate** through-hole location is marked indicated on the template; drill a 1/4" through-hole straight through the door and secure the **Rub Plate** with the 10-32 screw and nut bushing provided (be sure to place this un-slotted nut bushing on the outside door surface).

10. INSTALL THE MODEL 732 KEEPER

Before drilling holes for the **Double Door Keeper (Model 732)** in the surface of the inactive door, select the correct screws as follows:

For WOOD Doorframes

#10 x 1-1/2" Flat head,
Phillips Zinc Plated
(four count)



For Hollow METAL Doorframes

#10-24 x 5/8" Machine Screw,
Phillips Flat Head, Type F Thread
Cutting Stainless Steel (four
count)



When the **Double Door Keeper Base** position is finalized, drill two .157" (5/32") diameter holes, as shown on template, for the "locking" screws. Insert the appropriate screws into the round "locking" holes of the **Double Door Keeper Base**, and tighten the screws to securely fasten the keeper to the door jamb.

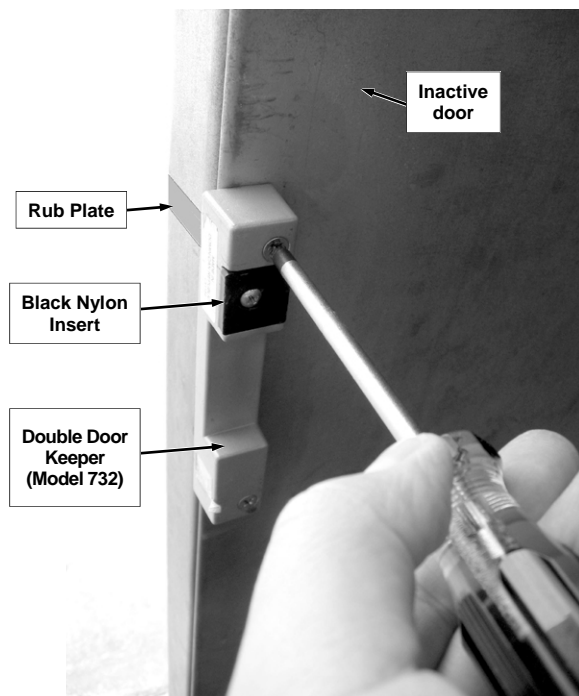

Fig. L: Install the **Double Door Keeper (Model 732)** on the inactive door. Note the location of the **Black Nylon Insert** and installed **Rub Plate**.

11. ADJUST THE BLACK NYLON INSERT

Close the door, project the deadbolt and adjust the **Black Nylon Insert** on the **Double Door Keeper Model 732** by loosening its hold-down screw and sliding the nylon insert against the lock latchbolt so the door is tightly latched and is free from rattle.

12. FINALIZING THE INSTALLATION

Ensure the 9-volt battery is installed and its plug is inserted into the lock **Sub-Ass'y PCB** (printed circuit board). Secure the **Lock Cover** with four #6-32 x 1/4" Phillips Truss Head, Zinc Plated screws.

Secure the Lock Cover

#6-32 x 1/4" Phillips Truss Head, Zinc
Plated (four count)



WATERPROOF MODELS

The waterproof models are basically identical to the standard models, except the waterproof models are specifically designed for outdoor applications. Weather-resistant for exposure to rain make them appropriate for use even in harsh conditions. In addition, the waterproof models are powered with a long-life 9VDC sealed alkaline battery pack (use part #S6173 only). These models include:

- **250WP** ... Clapper Plate Waterproof
- **700WP** ... Channel Push Bar Waterproof
- **710WP** ... Channel Push Bar Retriggerable Waterproof

Operating Instructions -- All Locks

OPERATING INSTRUCTIONS

BEFORE INSTALLING THE LOCK COVER:

1. Select either:
 - **Continuous Alarm** - Leave the black jumper plug on the terminal strip, as installed.
 - **Auto-Alarm Shutdown** - Remove the black jumper plug from the terminal strip.
2. Connect the battery connector to the 9-volt battery observing the proper polarity. A short beep will sound ensuring that the lock is powered and ready.
3. Install the **Lock Cover** with four #6-32 x 1/4" Phillips Truss Head, Zinc Plated screws.
4. Close the door.

OPERATIONAL TESTING

1. Lock and unlock the door using the cylinder key and note a small beep sounds when the deadbolt is retracted, indicating a disarmed condition. The door can now be opened without an alarm, by pushing the **Clapper Plate** or the **Push Bar Assy**.
2. Lock the door again and push the **Clapper Plate** (or **Push Bar Assy**) to open the door. Immediately the alarm pulses loudly and one of the following occurs:
 - If **Continuous Alarm** was selected, the alarm will sound until the lock is manually reset by locking the deadbolt with the key.
 - If **Auto-Alarm Shutdown** was selected, the alarm will sound for two minutes, then reset.







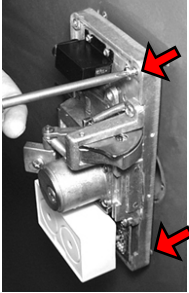

LOW BATTERY DETECTION

When the battery is weak, the sounder emits a short beep approximately once every minute. Always replace weak batteries as soon as possible. To access the 9-volt battery, remove the **Lock Cover** by unscrewing four #6-32 x 1/4" Phillips Truss Head, Zinc Plated screws.

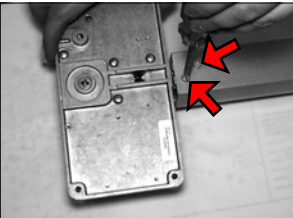

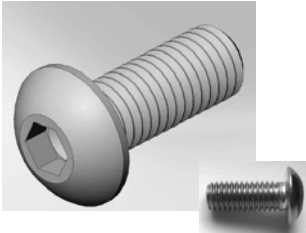
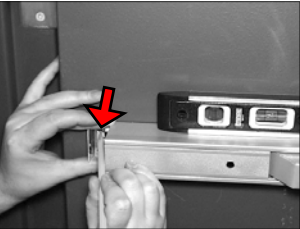

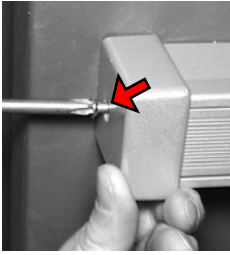



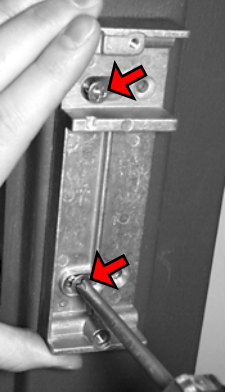

DOGGING OPERATION

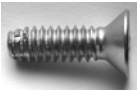
Insert the 3/16" L-shaped hexagonal Allen wrench (provided) into the dogging latch through the hole in the channel insert. Turn the dogging latch counter-clockwise 1/2 turn, push in the **Push Bar Assy** (or **Clapper Plate**), and turn the dogging latch clockwise 1/4 turn until it stops. Release the **Push Bar Assy**. The **Push Bar Assy** remains depressed when the lock is unlatched.

SCREW CHART

LOCATION	DESCRIPTION	IMAGE	SIZE SPECS
	Secures the Lock Base Plate Assembly to a SOLID WOOD DOOR		(Part # P1677) #10 x 1-3/4" Phillips Pan Head, Zinc Plated (four count)
	Secures the Lock Base Plate Assembly to a HOLLOW METAL DOOR		(Part # SC616LF) #10-24 x 1" Phillips Pan Head, Stainless Steel, Type F Thread Cutting (four count)
	Secures the Push Bar Assy to the Channel/Retaining Bracket (P5017)		(Part # P5460) #10-24 x 1/2" Phillips Flat Head, Undercut, Machine Screw, Zinc Plated (two count)
	Connects the Push Bar and Channel Assembly to the Clapper Arm Hinge		(Part # SC636) 10-32 x 1/2" Button Head Socket Cap Screw, Stainless Steel, use Allen wrench (1/8") to tighten (one count)
	Secures Retaining Bracket to a SOLID WOOD DOOR		(Part # P1671) #10 x 3/4" Phillips Pan head, Zinc Plated (two count)
	Secures Retaining Bracket to a HOLLOW METAL DOOR		(Part # SC617LF) #10-24 x 5/8" Phillips Pan Head, Stainless Steel, Type F Thread Cutting (two count)
	Mounts End Cap to Retaining Bracket		(Part # P5202) #10-24 x 1/2" Phillips Oval Head, Zinc Plated Machine Screw

SCREW CHART (Cont'd)

LOCATION	DESCRIPTION	IMAGE	SIZE SPECS
	Secures the SINGLE Door Keeper Base to a SOLID WOOD DOOR		(Part # P1676) #10 x 1-1/2" Flat head, Phillips Zinc Plated (four count)
	Secures the SINGLE Door Keeper Base to a HOLLOW METAL DOOR		(Part # SC618) #10-24 x 5/8" Machine Screw, Phillips Flat Head, Type F Thread Cutting Stainless Steel (four count)
	Secures the DOUBLE Door Keeper Base to a SOLID WOOD DOOR		(Part # P1676) #10 x 1-1/2" Flat head, Phillips Zinc Plated (four count)
	Secures the DOUBLE Door Keeper Base to a HOLLOW METAL DOOR		(Part # SC618) #10-24 x 5/8" Machine Screw, Phillips Flat Head, Type F Thread Cutting Stainless Steel (four count)
	Secures the Cover for the SINGLE Door Keeper Base		(Part # SC413) #8-32 x 5/8" Machine Screw, Phillips Flat Head, Zinc Plated (two count)
	Mounts Lock Cover to Lock Base Plate assembly.		(Part # P1508) #6-32 x 1/4" Phillips Truss Head, Zinc Plated (four count)

DETAIL ASSEMBLY OF 700 & 710 SERIES

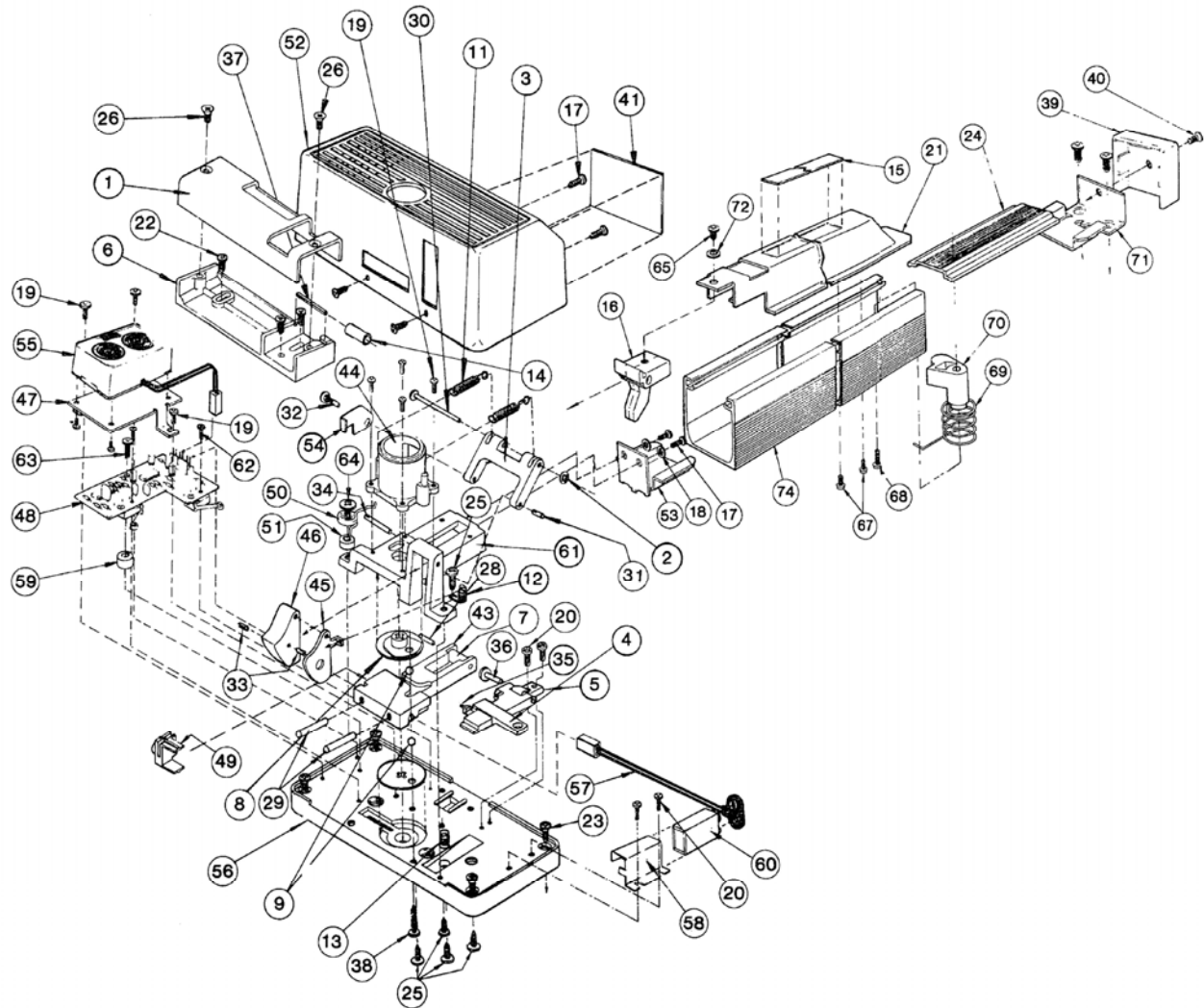

Important: Exploded view and part numbers below do NOT fully apply to waterproof "WP" models.

DES.	PART #	DESCRIPTION
1	P0248	KEEPER COVER
1	P0248G-312E	KEEPER COVER MTLIC BROWN*
2	P1140	(PART OF S5251 ASS'Y)
3	P5093	(PART OF S5252 ASS'Y)
4	P1151	(PART OF S3120 ASS'Y)
5	HW1607	(PART OF S3120 ASS'Y)
6	P1157	KEEPER BASE
7	P1158	(PART OF S3113 ASS'Y)
8	P1159	(PART OF S3114 ASS'Y)
9	P1160	(PART OF S3114 ASS'Y)
11	P1168	(PART OF S5252 ASS'Y)
12	P1169	LATCH TRIP SPRING
13	P1170	D'LOCK LEVER SPRING
14	P1171	(PART OF ROLLER)
15	P5023	LABEL-PUSH BAR
16	P5022	CLAPPER ARM-HINGE BKT.
17	P1508	6-32 X 1/4 L TRUSS HD.
18	WA143	INTERNAL LOCKWASHER
19	P1520	(PART OF HW908LF; SEE #55)
20	SC466	6 X 3/8 SELF TAP, PH PHIL.
21	P5010	PUSH BAR & ASSY
22	P1676	(WOOD MOUNTING SCREW)
22	SC618	(METAL MOUNTING SCREW)
22	SC618	10-24 X 5/8", PHIL FLT HD TYPE F STNLS
23	P1677	(WOOD MOUNTING SCREW)
23	SC616LF	(METAL MOUNTING SCREW)
24	P5046	CHANNEL INSERT
25	SC617LF	10-24X5/8 PHIL PAN STF ST LSS
26	SC413	8-32 X 5/8 MS ZINC PLT
27	P5100	CHANNEL INSERT (DURANODIC)*
28	P1927	(PART OF S3113 ASS'Y)
29	P1928	(PART OF S3113 ASS'Y)
30	P1929	(PART OF S5251 ASS'Y)
31	P1930	(PART OF S5252 ASS'Y)
32	P1931	(PART OF S5252 ASS'Y)
33	P1932	(PART OF S5252 ASS'Y)
34	P1933	(PART OF S5252 ASS'Y)
35	P1934	(PART OF S3120 ASS'Y)
36	P1935	(PART OF S3120 ASS'Y)
37	P1937	(PART OF ROLLER)
38	P4155	10-24 X 5/8 PH PHIL.
39	P5034	END CAP
40	P5202	10-24 X 1/2 L OVAL HD. PHIL.
41	P5233	PROD-LABEL 700/710
42	P5110	LOCK COVER (DURANODIC)*
43	P1143	(PART OF S3113 ASS'Y)
44	P1145	(PART OF S5252 ASS'Y)
45	P1149	(PART OF S5252 ASS'Y)
46	P1150	(PART OF S5252 ASS'Y)
47	P5012	(PART OF HW908LF; SEE #55)
48	P5011	SUB-ASS'Y PCB (VARIES WITH MODEL)
49	P5019	CAM FOLLOWER
50	P5422	TENSION SPRING
51	P5030	TENSION SPRING SPACER
52	P5014	LOCK COVER (ALUM)
53	P5017	CHANNEL/RETAINING BRACKET
54	P5054	(PART OF S5252 ASS'Y)
55	HW908LF	PIEZO W/MOUNTING BRKT ASSY
56	P5063	LOCK BASE PLATE
57	9S5229ASSY	BATTERY CONNECTOR
58	P5077	BATTERY CLAMP BKT.
59	P5089	SPACER, NYLON 1/4 L
60	P5103	BATTERY, 9-VOLT
61	P5121	(PART OF S5252 ASS'Y)
62	P5195	2-56 X 1/2 L PH PHIL.
63	P5195	2-56 X 1/2 L PH PHIL.
63	SC604	2-56 X 1/2 MS PHIL PAN STNLS (WP)
64	SC465	10 X 3/4 PH PHIL TYPE 23
64	SC605	10 X 3/4 PHIL PAN T23 STNLS (WP)
65	SC636	BUTTN HD HEX 1/8" 10-32 X 1/2 SS
66	P5099	BASE CHANNEL (DURANODIC)*
67	P1735	10-32 X 3/8L PH PHIL
68	P5204	(PART OF S5253 ASS'Y)
69	P5048	(PART OF S5253 ASS'Y)
70	P5047	(PART OF S5253 ASS'Y)
71	P5045	RETAINING BKT.
72	P5201	LOCKWASHER #10 INT STAR ZINC
73	P5109	END CAP (DURANODIC)*
74	P5011	BASE CHANNEL
75	P5108	PUSH BAR & ASS'Y (DURANODIC)*

*Optional parts available. Contact your sales representative for more information.

DETAIL ASSEMBLY OF 250 & 260 SERIES

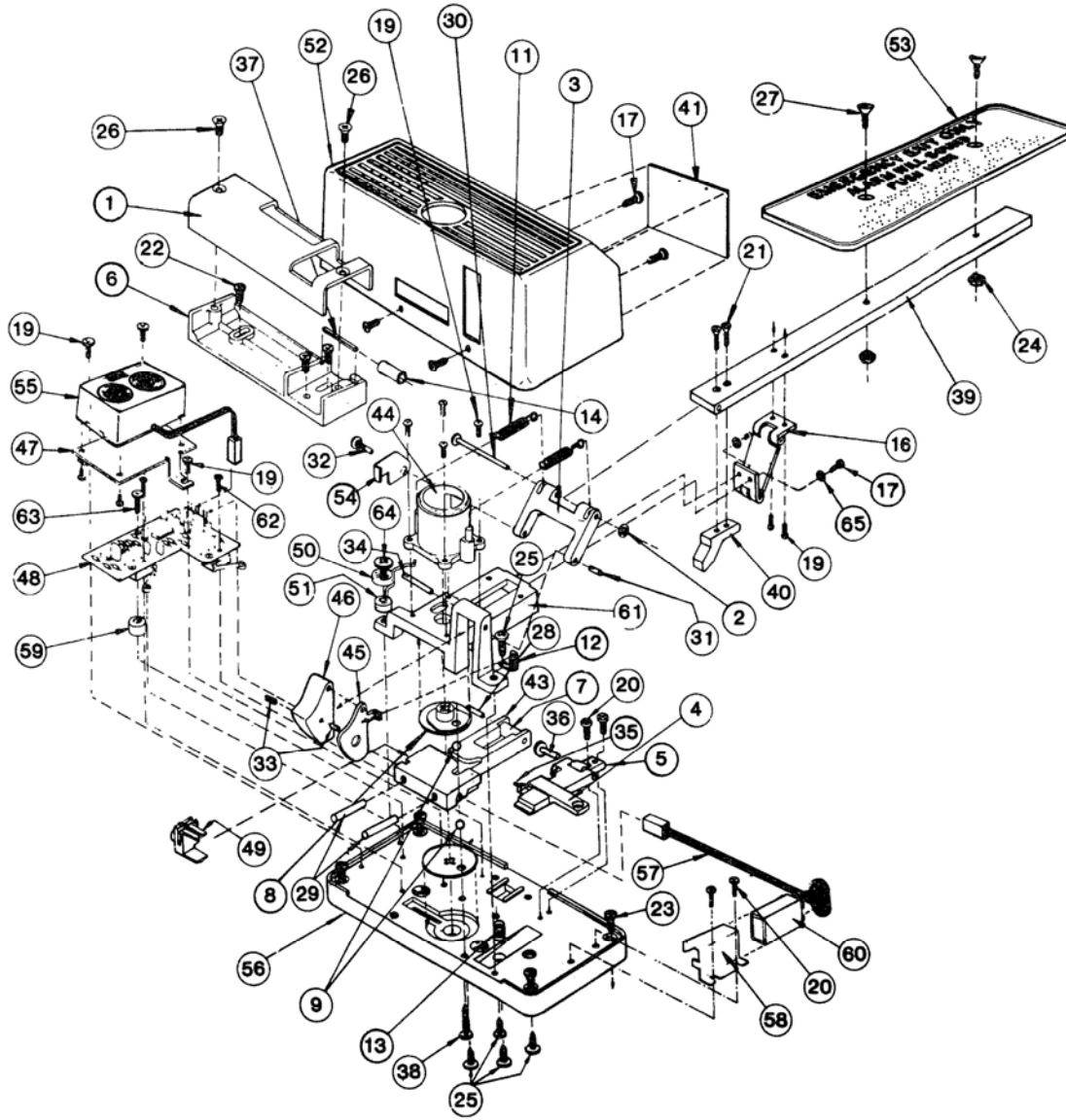

Important: Exploded view and part numbers below do NOT fully apply to waterproof "WP" models.

#...PART#	DESCRIPTION			
1....P0248	KEEPER COVER	22..P1676	(WOOD MOUNTING SCREW)	44 . P1145.....(PART OF S5252 ASS'Y)
1....P0248G-312E	KEEPER COVER MTLIC BROWN*	22..SC618	(METAL MOUNTING SCREW)	45 . P1149.....(PART OF S5252 ASS'Y)
2....P1140	(PART OF S5251 ASS'Y)	23..P1677	(WOOD MOUNTING SCREW)	46 . P1150.....(PART OF S5252 ASS'Y)
3....P5093	(PART OF S5252 ASS'Y)	23..SC616LF	(METAL MOUNTING SCREW)	47 . P5012.....(PART OF HW908LF; SEE #55)
4....P1151	(PART OF S3120 ASS'Y)	24..P1684	NUT 10-32 X 3/8 HEX.	48SUB-ASS'Y PCB (VARIES WITH MODEL)
5....HW1607	(PART OF S3120 ASS'Y)	25..SC617LF	10-24X5/8 PHIL PAN STF ST LSS	49 . P5019.....CAM FOLLOWER
6....P1157	KEEPER BASE	26..SC413	8-32 X 5/8 MS ZINC PLT	50 . P5422TENSION SPRING
7....P1158	(PART OF S3113 ASS'Y)	27..P1748	10-32 X 3/4 L OVAL HD.	51 . P5030.....TENSION SPRING SPACER
8....P1159	(PART OF S3114 ASS'Y)	28..P1927	(PART OF S3113 ASS'Y)	52 . P5031.....LOCK COVER (ALUM)
9....P1160	(PART OF S3114 ASS'Y)	29..P1928	(PART OF S3113 ASS'Y)	53 . P5050.....CLAPPER PLATE
11..P1168	(PART OF S5252 ASS'Y)	30..P1929	(PART OF S5251 ASS'Y)	54 . P5054.....(PART OF S5252 ASS'Y)
12..P1169	LATCH TRIP SPRING	31..P1930	(PART OF S5252 ASS'Y)	55 . HW908LF.....PIEZO W/MOUNTING BRKT ASSY
13..P1170	D'LOCK LEVER SPRING	32..P1931	(PART OF S5252 ASS'Y)	56 . P5063.....LOCK BASE PLATE
14..P1171	(PART OF ROLLER)	33..P1932	(PART OF S5252 ASS'Y)	57 . 9S5229ASSY ..BATTERY CONNECTOR
15..P1250	CLAPPER PLATE (LONG)*	34..P1933	(PART OF S5252 ASS'Y)	58 . P5077.....BATTERY CLAMP BRACKET
16..P1260	HINGE	35..P1934	(PART OF S3120 ASS'Y)	59 . P5089.....SPACER, NYLON 1/4 L
17..P1508	6-32 X 1/4 L TRUSS HD.	36..P1935	(PART OF S3120 ASS'Y)	60 . P5103.....BATTERY, 9-VOLT
18..P4545	CLAPPER ARM	37..P1937	(PART OF ROLLER)	61 . P5121.....(PART OF S5252 ASS'Y)
19..SC545	6-32 X 3/8, FLAT HD, TAPTITE, PHIL	38..P4155	10-24 X 5/8 PH PHIL.	62 . P5195.....SCREW, 2-56 X 1/2 L PH PHIL.
19..SC601	(FOR WP MODELS)	39..P4493	CLAPPER ARM	63 . P5195.....2-56 X 1/2 L PH PHIL.
20..SC466	6 X 3/8 SELF TAP, PH PHIL.	40..P4495	TRIGGER CAM	63 . SC6042-56 X 1/2 MS PHIL PAN STNLSS (WP)
21..SC413	8-32 X 5/8 MS ZINC PLT	41..P5232	PROD-LABEL 250/260	64 . SC46510 X 3/4 PH PHIL TYPE 23
21..SC600	(FOR WP MODELS)	42..P5111	LOCK COVER (DURANODIC)*	64 . SC60510 X 3/4 PHIL PAN T23 STNLSS (WP)
		43..P1143	(PART OF S3113 ASS'Y)	65 . WA143INTERNAL TOOTH LOCK WASHER

*Optional parts available. Contact your sales representative for more information.

ALARM LOCK LIMITED WARRANTY

ALARM LOCK SYSTEMS, INC. (ALARM LOCK) warrants its products to be free from manufacturing defects in materials and workmanship for twenty four months following the date of manufacture. ALARM LOCK will, within said period, at its option, repair or replace any product failing to operate correctly without charge to the original purchaser or user.

This warranty shall not apply to any equipment, or any part thereof, which has been repaired by others, improperly installed, improperly used, abused, altered, damaged, subjected to acts of God, or on which any serial numbers have been altered, defaced or removed. Seller will not be responsible for any dismantling or reinstallation charges, environmental wear and tear, normal maintenance expenses, or shipping and freight expenses required to return products to ALARM LOCK. Additionally, this warranty shall not cover scratches, abrasions or deterioration due to the use of paints, solvents or other chemicals.

THERE ARE NO WARRANTIES, EXPRESS OR IMPLIED, WHICH EXTEND BEYOND THE DESCRIPTION ON THE FACE HEREOF. THERE IS NO EXPRESS OR IMPLIED WARRANTY OF MERCHANTABILITY OR A WARRANTY OF FITNESS FOR A PARTICULAR PURPOSE. ADDITIONALLY, THIS WARRANTY IS IN LIEU OF ALL OTHER OBLIGATIONS OR LIABILITIES ON THE PART OF ALARM LOCK.

Any action for breach of warranty, including but not limited to any implied warranty of merchantability, must be brought within the six months following the end of the warranty period.

IN NO CASE SHALL ALARM LOCK BE LIABLE TO ANYONE FOR ANY CONSEQUENTIAL OR INCIDENTAL DAMAGES FOR BREACH OF THIS OR ANY OTHER WARRANTY, EXPRESS OR IMPLIED, EVEN IF THE LOSS OR DAMAGE IS CAUSED BY THE SELLER'S OWN NEGLIGENCE OR FAULT.

In case of defect, contact the security professional who installed and maintains your security system. In order to exercise the warranty, the product must be returned by the security professional, shipping costs prepaid and insured to ALARM LOCK. After repair or replacement, ALARM LOCK assumes the cost of returning products under warranty. ALARM LOCK shall have no obligation under this warranty, or otherwise, if the product has been repaired by others, improperly installed, improperly used, abused, altered, damaged, subjected to accident, nuisance, flood, fire or acts of God, or on which any serial numbers have been altered, defaced or removed. ALARM LOCK will not be responsible for any dismantling, reassembly or reinstallation charges, environmental wear and tear, normal maintenance expenses, or shipping and freight expenses required to return products to ALARM LOCK. Additionally, this warranty shall not cover scratches, abrasions or deterioration due to the use of paints, solvents or other chemicals.

This warranty contains the entire warranty. It is the sole warranty and any prior agreements or representations, whether oral or written, are either merged herein or are expressly cancelled. ALARM LOCK neither assumes, nor authorizes any other person purporting to act on its behalf to modify, to change, or to assume for it, any other warranty or liability concerning its products.

In no event shall ALARM LOCK be liable for an amount in excess of ALARM LOCK's original selling price of the product, for any loss or damage, whether direct, indirect, incidental, consequential, or otherwise arising out of any failure of the product. Seller's warranty, as hereinabove set forth, shall not be enlarged, diminished or affected by and no obligation or liability shall arise or grow out of Seller's rendering of technical advice or service in connection with Buyer's order of the goods furnished hereunder.

ALARM LOCK RECOMMENDS THAT THE ENTIRE SYSTEM BE COMPLETELY TESTED WEEKLY.

Warning: Despite frequent testing, and due to, but not limited to, any or all of the following; criminal tampering, electrical or communications disruption, it is possible for the system to fail to perform as expected. ALARM LOCK does not represent that the product/system may not be compromised or circumvented; or that the product or system will prevent any personal injury or property loss by burglary, robbery, fire or otherwise; nor that the product or system will in all cases provide adequate warning or protection. A properly installed and maintained alarm may only reduce risk of burglary, robbery, fire or otherwise but it is not insurance or a guarantee that these events will not occur. CONSEQUENTLY, SELLER SHALL HAVE NO LIABILITY FOR ANY PERSONAL INJURY, PROPERTY DAMAGE, OR OTHER LOSS BASED ON A CLAIM THE PRODUCT FAILED TO GIVE WARNING. Therefore, the installer should in turn advise the consumer to take any and all precautions for his or her safety including, but not limited to, fleeing the premises and calling police or fire department, in order to mitigate the possibilities of harm and/or damage.

ALARM LOCK is not an insurer of either the property or safety of the user's family or employees, and limits its liability for any loss or damage including incidental or consequential damages to ALARM LOCK's original selling price of the product regardless of the cause of such loss or damage.

Some states do not allow limitations on how long an implied warranty lasts or do not allow the exclusion or limitation of incidental or consequential damages, or differentiate in their treatment of limitations of liability for ordinary or gross negligence, so the above limitations or exclusions may not apply to you. This Warranty gives you specific legal rights and you may also have other rights which vary from state to state.