

Price List 2024

ELELCTRIFIED LOCKING HARDWARE

commandaccess.com

⚡ Always here to help ⚡

888-622-2377

TERMS & TEAM	2	POWER SUPPLIES	22
ELECTRIFIED MORTISE LOCKS	4	POWER ACCESSORIES	23
ELECTRIFIED CYLINDRICAL LOCKS	10	POWER TRANSFER HINGES	24
ELECTRIFIED EXIT TRIM	13	POWER TRANSFER PIVOTS	30
EXIT DEVICES & KITS	16	DOOR LOOPS	31



COMMAND ACCESS TERMS

PRICES: All list prices are subject to change without prior notice and are not guaranteed. All prices are per unit (each) unless otherwise specified and do not include sales or local taxes. All shipments will be made at prices prevailing at time of shipment.

EXPEDITE FEE: A customer may request that an order be expedited. An additional charge of up to 25% of the cost of the expedited items may be charged. Expedite lead times are subject to availability. Please call for approval.

PAYMENT TERMS: The standard credit terms of Command Access Technologies (herein called CAT) are 2% 10 days net 30. Net 30 means the check shall be received at CAT on or before 30 days from the date of the invoice. Interest will be charged at the rate of 2% per month on past due accounts.

ACCEPTANCE OF ORDERS AND/OR QUOTATIONS: Possession of prices from CAT does not commit CAT to accept any order. CAT reserves the right to refuse any order and will not be bound to fulfill any order until it has been accepted by a representative of CAT and confirmed by a written acknowledgement. Quotations are valid for thirty (30) days following the date of the quotation.

OPEN ACCOUNT STATUS: CAT reserves the right to decline or discontinue direct sales to any customer who does not meet an annual minimum sales requirement of **\$10,000.00** in invoiced purchases.

ACKNOWLEDGEMENTS: An acknowledgement is an exact copy of a customer's order as entered by CAT and should be verified by the customer. If the acknowledgement does not agree with said customer's understanding CAT should be advised within (3) three days or the order will be billed as acknowledged. CAT's sales terms shall apply irrespective of any special stipulation appearing in customer order, unless specifically acknowledged and accepted by CAT.

RETURNED GOODS: The customer must advise customer service at CAT of merchandise to be returned and a Returned Goods Authorization (RGA) will be issued. CAT will not accept goods returned without an RGA. Full credit against further purchases or a replacement will be made at the option of CAT if upon investigation reveals that goods were shipped in error or if goods are defective in workmanship or material. Otherwise, a restocking fee of not less than (25) twenty-five percent will be charged. All merchandise must be PREPAID AND PROPERLY PACKED. All C.O.D. orders shipped to CAT will be refused. Returned goods must be packed in their original boxes. If product has been installed it cannot be returned but only repaired, please consult factory for repair costs (unless under warranty). No credit will be given for product not in its original form unless, upon CAT's inspection, product is found to be defective. If product is returned as defective and is found to be operational, product will be returned to customer (C.O.D.) and no credit will be issued.

MINIMUM CHARGE: No order will be invoiced for less than \$25.00 net plus shipping charges.

CHANGES OR CANCELLATIONS: When a special order is accepted, and entered, no change can be made and the order is non-cancellable. Cancellation for items already packed for shipment will be removed if possible. A twenty-five percent (25%) restocking fee will apply.

CLAIMS OR SHORTAGES: Every possible care is taken in the final examination of packing of goods, and no complaints will be accepted unless made promptly upon receipt of goods. No claim will be allowed for work done by others, consequential damages or other expenditure, and CAT's understanding to repair or replace defective goods is its only liability. No claim for damage, shortage or loss in transit will be accepted unless notice is given in writing to the carrier and to CAT within (10) ten days of receipt of goods.

BACK CHARGES: CAT is not responsible for, does not authorize, and will not accept any charges for the cost of labor, travel or material incurred by anyone other than CAT for any installation, repair, service, or replacement unless incurred with CAT's prior written consent and agreement.

FREIGHT CHARGES: All goods are invoiced F.O.B. CAT, Yorba Linda, California. Freight charges are prepaid and are added to invoice. Consignee pays C.O.D. freight charges when delivered to the Freight Company the shipment becomes the property of the purchaser, who assumes the risk of loss or damage in transit. If invoice exceeds \$1,000.00 net, full service freight by UPS or our choice within the continental U.S.A. (excluding Hawaii, Alaska, Guam & Puerto Rico) is deductible, provided invoice is paid within set terms. Not all products qualify for freight deduction. Airfreight and other special shipments are not deductible. CAT does not ship to directly to Canada, for all Canadian destinations please contact Connection Network Agencies at 905-823-3002.

PRODUCT CHANGES OR CANCELLATIONS: CAT reserves the right to modify or discontinue any price, product, design, function and finish without prior notice.

PRODUCT FINISHES: Although CAT modifies products with the finest protective coatings, they do have their limitations. In time, they might deteriorate from extremes in climate, frequency of use, perspiration, or other factors. CAT does not consider excessive wear or tarnishing of the finish because of any of the above conditions as a defect. It is considered a normal process, which cannot be avoided. Thus, CAT cannot guarantee product finishes and will not repair or replace finishes under this warranty.

COMMAND TEAM ROSTER

DAYENA CHERRY

CSR TEAM MEMBER
DC@COMMANDACCESS.COM

JORDAN HENDERSON

CSR TEAM MEMBER
JH@COMMANDACCESS.COM

DANNY LOPEZ

CSR TEAM MEMBER
DL@COMMANDACCESS.COM

HAYLI THURMAN

CSR TEAM MEMBER
HT@COMMANDACCESS.COM

JOHN VAN ANDRIGHEM

TECH SUPPORT LEAD
JV@COMMANDACCESS.COM

SARAH AFARIAN

CSR MANAGER
SA@COMMANDACCESS.COM

BRIAN KENLEY

DIRECTOR OF TECHNICAL SERVICES
BWK@COMMANDACCESS.COM

JERRAD FREYMUTH

DIRECTOR OF SALES
JF@COMMANDACCESS.COM

MATEO KRISTOFF

VP SALES & MARKETING
MK@COMMANDACCESS.COM



WORLD HEADQUARTERS: 22901 LA PALMA AVE., YORBA LINDA CA 92887

EAST COAST WAREHOUSE: 106 SPRING LAKE DRIVE, NEW BRITAIN, PA 18901



WHAT ALWAYS HERE TO HELP MEANS...

- WE ANSWER THE PHONE WITH A **LIVE VOICE**, MONDAY THRU FRIDAY 7:30AM - 4:00PM PST
- OUR CUSTOMER SERVICE DEPARTMENT STRIVES TO **DELIVER EXCELLENT CUSTOMER SATISFACTION**
- OUR **LIVE CHAT** IS OPERATED BY OUR CUSTOMER SERVICE TEAM MAKING IT EASY TO GET A HOLD OF US, ESPECIALLY IF YOU LIKE TO MULTI-TASK
- OUR **LEAD TIMES ARE 5-10 DAYS** FOR CATALOGED ITEMS. IF WE CAN SHIP SOONER, WE WILL SURE TRY!
- IF WE MAKE A MISTAKE, WE ARE COMMITTED TO MAKING IT RIGHT
- OUR WEBSITE IS USER FRIENDLY AND EXPANDING DAILY WITH INFORMATION & DEMONSTRATION VIDEOS
- WE HAVE COMPETENT, REACHABLE TECHNICAL SUPPORT EVERYDAY DURING BUSINESS HOURS
- ANYONE WHO NEEDS OUR SUPPORT GETS IT
- WE ARE WILLING TO TRAIN ON SITE, AT YOUR CUSTOMERS OR VIA WEBINAR
- WE TAKE GOOD MECHANICAL PRODUCTS & MAKE THEM BETTER ELECTROMECHANICAL PRODUCTS
- WE WILL SHIP REPLACEMENT PRODUCTS AS SOON AS POSSIBLE, USUALLY WITHIN THE NEXT BUSINESS DAY
- WE STRIVE TO ACKNOWLEDGE YOUR ORDER WITHIN 24 HOURS
- ALL OF OUR DOCUMENTS, INCLUDING ACKNOWLEDGMENTS, INVOICES, STATEMENTS, AND RMA'S WILL BE EMAILED



LIMITED WARRANTY: Command Access Technologies warrants that its products are free from defects in workmanship and material under normal use and service. Since CAT does not control product usage, CAT makes no representation as to the degree of security conveyed by the use of any product. This warranty does not cover defects or damage which occur from improper maintenance, improper storage, improper installation, shipping and handling, ordinary wear and tear, misuse, abuse, accidents, unauthorized service, work done by others or consequential damages. CAT will not pay for the cost of repair performed other than in accordance with this warranty. CAT can only perform authorized warranty work at the factory. CAT's only liability, in tort or contract, whether under this warranty or otherwise, is limited to providing repair or replacement of any product or component part which is proven to be defective as covered by the warranty, within three (3) years after delivery from CAT to the original purchaser. Written notice of a product or component part believed to be defective, as covered by this warranty, should be sent to Command Access Technologies 22901 La Palma Avenue, Yorba Linda, CA 92887. Include Claimant's name, address, phone, and identification of the product, invoice number and date, and a brief description of the defect. Upon receipt of such notice, a CAT representative will contact claimants to where to ship such product or component part, with shipping charges prepaid, for examination and, in the event such examination reveals a defect covered by this warranty, the product will be repaired (existing product installed 6+ months) or replaced (all new installations of 6 months or less). This warranty is in lieu of all other express warranties. To the extent permitted by law, all implied warranties are limited to the duration of this warranty. CAT shall not be liable for any incident or consequential damages. Some states do not allow limitations on how long an implied warranty lasts or the exclusion or limitation of incidental or consequential damages, so the above may not apply to you. This warranty gives you specific legal rights, and you may have other rights, which vary, from state to state.



ELECTRIFIED MORTISE LOCKS

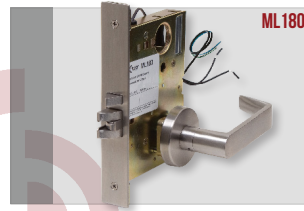

FOR MODIFICATION, CHASSIS ONLY AND COMPLETE LOCKS

PREFIX or SUFFIX

MD - Modification - Prefix
CH - Chassis Only - Suffix

MODEL + FUNCTION

Select a model number and add
EL (Fail Safe) - Electronically Locked
EU (Fail Secure) - Electronically Unlocked

VOLTAGE

12 or 24 Volts must be specified
Motorized = Universal Input 11-30V

OPTIONAL SWITCHES

REX - Request-to-Exit DBM - Deadbolt Monitor
DPS - Door Position Switch
LBM - Latchbolt Monitor

M-OPTION FOR MORTISE LOCK



For Command Access & Schlage model #s only.

- Intelligent auto voltage sensing 11-30 VDC
- Extremely low holding current = motorized
- Field selectable EU/EL with press of a button

FOR AND COMPLETE LOCKS ONLY

TRIM

- Tubular - Straight - Escutcheon
 - Bent - Curved

FINISH (BHMA std)

613 - Oil Rubbed Bronze 626 - Satin Chrome
625 - Polished Chrome
SPECIAL ORDER
605 - Polished Bronze 612 - Satin Bronze
606 - Satin Brass 630 - Satin Stainless

KEYWAY

S - "C" Kwy Standard SFIC - Small Format I/C Prep
LC - Less Cylinder LFIC - Factory Large Format I/C Prep

ACCESSORIES

Faceplates - Storeroom function in specified finishes
Strikes - 4-7/8" ASA Strike in specified finishes
CRU2 - Current Reduction Unit (AC & DC input)
4 Lead - 4' Wire Lead to switches
10 Lead - 10' Wire lead to switches
QC - Molex Connectors
BR1 - Bridge Rectifier w/ 12" lead (included)
BR5 - Bridge Rectifier w/ 5' lead

EXAMPLES

MODIFICATION ONLY

	PREFIX	MODEL	FUNCTION	SUFFIX	VOLTAGE	FINISH	KEYWAY	OPTIONS	ACC	COMPLETE PART #
Part #	MD	ML80	EL	-	12V	-	-	REX	CRU2	MDML80 EL 12V REX CRU2
List \$	-	\$160	-	-	-	-	-	\$70	\$39	\$269

CHASSIS ONLY

	PREFIX	MODEL	FUNCTION	SUFFIX	VOLTAGE	FINISH	KEYWAY	OPTIONS	ACC	COMPLETE PART #
Part #	-	ML19092	EU	CH	-	-	-	REX LBM	-	ML19092 EU CH REX LBM
List \$	-	\$430	-	-	-	-	-	\$140	-	\$570

COMPLETE LOCK

	PREFIX	MODEL	FUNCTION	SUFFIX	VOLTAGE	FINISH	KEYWAY	OPTIONS	ACC	COMPLETE PART #
Part #	-	ML1485	EU	L3B	24V	626	S	REX	QC	ML1485 EU L3B 24V 626 S REX QC
List \$	-	\$740	-	+\$18	-	-	-	\$70	\$28	\$860

Command Access is not a licensee or affiliated, associated or connected with Allegion, Assa Abloy, Dorma, Stanley Security, Adams Rite, Arrow, Corbin Russwin, Mckinney, Pemko, Rixson, Sargent, Yale, Dor-O-matic, Falcon, Ives, Monarch, Schlage, Von Duprin, Best, Precision, Accurate, AHT, Baldwin, Bommer, Cal Royal, CR Laurence, Design Hardware, Emtek, First Choice, FSB, General Lock, Hager, Jackson, Keedex, Lawrence, LSDA, Marks, Marshal-Best, Molex, Omnia, PBB, PDQ, or any of their subsidiaries or affiliates.

COMMAND ACCESS ML1 SERIES

COMMAND ACCESS COMPLETE LOCK RETROFIT SCHLAGE L9000

Specify Voltage. Field Hand-able. Fail Secure/Fail Safe. LFIC = Schlage compatible housing

SOLENOID LOCKS

PART #	COMPLETE LOCK LIST \$	CHASSIS ONLY LIST \$	IN-STOCK TRIM							IN-STOCK FINISHES			KEYWAY			OPTIONAL SWITCHES			
			L3	L6	L7	L17	B ROSE	626	625	613	LC	SC	SFIC	LFIC	REX	LBM	DPS	DBM	
ML170EU/EL	\$670	\$350	L3	L6	L7	L17	+\$18	+\$55	✓	✓	✓	-	✓	+\$66	+\$28	+\$70	+\$70	-	-
ML180EU/EL	\$650	\$330	L3	L6	L7	L17	+\$18	+\$55	✓	✓	✓	-	✓	+\$66	+\$28	+\$70	+\$70	+\$70	-
ML182EU/EL	\$685	\$340	L3	L6	L7	L17	+\$18	-	✓	✓	✓	-	✓	+\$132	+\$56	+\$70	+\$70	+\$70	-
ML1480EU/EL	\$690	\$370	L3	L6	L7	L17	+\$18	-	✓	✓	✓	-	✓	+\$66	+\$28	+\$70	+\$70	-	+\$70
ML1482EU/EL	\$725	\$380	L3	L6	L7	L17	+\$18	-	✓	✓	✓	-	✓	+\$132	+\$56	+\$70	+\$70	-	+\$70
ML1485EU	\$740	\$420	L3	L6	L7	L17	+\$18	-	✓	✓	✓	-	✓	+\$66	+\$28	+\$70	+\$70	-	+\$70
ML156EU	\$740	\$420	L3	L6	L7	L17	+\$18	-	✓	✓	✓	-	✓	+\$66	+\$28	+\$70	+\$70	-	+\$70

✓ or \$ = Available
- = Not Available



MOTORIZED LOCKS

ML19092-M	\$750	\$430	L3	L6	L7	L17	+\$18	+\$55	✓	✓	✓	-	✓	+\$66	+\$28	+\$70	+\$70	+\$70	-
ML19095-M	\$785	\$440	L3	L6	L7	L17	+\$18	+\$55	✓	✓	✓	-	✓	+\$132	+\$56	+\$70	+\$70	+\$70	-

MECHANICAL LOCKS

ML1010	\$495	\$185	L3	L6	L7	L17	+\$18	+\$55	✓	✓	✓	-	✓	+\$66	+\$28	+\$70	+\$70	+\$70	-
ML1040	\$516	\$196	L3	L6	L7	L17	+\$18	+\$55	✓	✓	✓	-	✓	+\$66	+\$28	+\$70	+\$70	-	-
ML1053	\$534	\$214	L3	L6	L7	L17	+\$18	-	✓	✓	✓	-	✓	+\$66	+\$28	+\$70	+\$70	-	+\$70
ML1050/70	\$523	\$203	L3	L6	L7	L17	+\$18	+\$55	✓	✓	✓	-	✓	+\$66	+\$28	+\$70	+\$70	+\$70	-
ML1080	\$523	\$203	L3	L6	L7	L17	+\$18	+\$55	✓	✓	✓	-	✓	+\$66	+\$28	+\$70	+\$70	+\$70	-
ML1082	\$553	\$208	L3	L6	L7	L17	+\$18	-	✓	✓	✓	-	✓	+\$132	+\$56	+\$70	+\$70	+\$70	-

COMMAND ACCESS

RETROFIT CHASSIS ONLY

Specify Voltage, Fail Safe (EL) or Fail Secure (EU) and Handing. Includes 626 faceplate & strike (other finishes available upon request at an upcharge \$60).

MRC1 SERIES

✓ or \$ = Available
- = Not Available

	PART #	LIST \$	626	LC	SC	SFIC	LFIC	REX	LBM	DPS	DBM
BEST 35 SERIES	MRC135D EU/EL	\$425	✓	-	-	✓	-	+\$70	+\$70	+\$70	-
	MRC135W EU/EL	\$450	✓	-	-	✓	-	+\$70	+\$70	+\$70	-
CAL ROYAL 8800 SERIES	MRC18080 EU/EL	\$425	✓	✓	+\$34	+\$66	+\$28	+\$70	+\$70	+\$70	-
	MRC18082 EU/EL	\$450	✓	✓	+\$34	+\$66	+\$56	+\$70	+\$70	+\$70	-
CORBIN RUSSWIN 2000 SERIES	MRC105/03 EU/EL	\$425	✓	✓	+\$34	+\$66	+\$28	+\$70	+\$70	+\$70	-
	MRC104/01 EU/EL	\$450	✓	✓	+\$34	+\$66	+\$56	+\$70	+\$70	+\$70	-
FALCON MA SERIES	MRC181/51 EU/EL	\$425	✓	✓	+\$34	+\$66	+\$28	+\$70	+\$70	+\$70	-
	MRC121/11 EU/EL	\$450	✓	✓	+\$34	+\$66	+\$56	+\$70	+\$70	+\$70	-
	MRC1681/51 EU/EL	\$450	✓	✓	+\$34	+\$66	+\$28	+\$70	+\$70	-	+\$70
SARGENT 8200 SERIES	MRC1370/71 EU/EL	\$425	✓	✓	+\$34	+\$66	+\$28	+\$70	+\$70	+\$70	-
	MRC1373/11 EU/EL	\$450	✓	✓	+\$34	+\$66	+\$56	+\$70	+\$70	+\$70	-

Command Access is not a licensee or affiliated, associated or connected with Allegion, Assa Abloy, Dorma, Stanley Security, Adams Rite, Arrow, Corbin Russwin, McKinney, Pemko, Rixson, Sargent, Yale, Dor-O-matic, Falcon, Ives, Monarch, Schlage, Von Duprin, Best, Precision, Accurate, AHT, Baldwin, Bommer, Cal Royal, CR Laurence, Design Hardware, Emtek, First Choice, FSB, General Lock, Hager, Jackson, Keedex, Lawrence, LSDA, Marks, Marshal-Best, Molex, Omnia, PBB, PDQ, or any of their subsidiaries or affiliates.



ELECTRIFIED LATCH PULLBACK



COMMAND ACCESS LPM190 SERIES



SEE IT IN ACTION!

PART #	COMPLETE LOCK LIST \$	CHASSIS ONLY LIST \$	IN-STOCK TRIM				IN-STOCK FINISHES				KEYWAY			OPTIONAL SWITCHES				
			L3	L6	L7	L17	B ROSE	626	625	613	LC	SC	SFIC	LFIC	REX	LBM	DPS	
LPM1910 ¹	\$983	\$673	L3	L6	L7	L17	+\$18	+\$55	✓	✓	✓	-	✓	+\$66	+\$28	+\$70	+\$70	- ²
LPM190 ¹	\$993	\$673	L3	L6	L7	L17	+\$18	+\$55	✓	✓	✓	-	✓	+\$66	+\$28	+\$70	+\$70	- ²
LPM192 ¹	\$1035	\$695	L3	L6	L7	L17	+\$18	-	✓	✓	✓	-	✓	+\$66	+\$28	+\$70	+\$70	- ²
LPM193 ¹	\$1172	\$832	L3	L6	L7	L17	+\$18	+\$55	✓	✓	✓	-	✓	+\$66	+\$28	+\$70	+\$70	- ²
LPM194 ¹	\$1172	\$832	L3	L6	L7	L17	+\$18	+\$55	✓	✓	✓	-	✓	+\$66	+\$28	+\$70	+\$70	- ²
LPM195 ¹	\$1172	\$832	L3	L6	L7	L17	+\$18	-	✓	✓	✓	-	✓	+\$66	+\$28	+\$70	+\$70	- ²
LPM196 ¹	\$1172	\$832	L3	L6	L7	L17	+\$18	-	✓	✓	✓	-	✓	+\$66	+\$28	+\$70	+\$70	- ²
LPM197 ¹	\$1172	\$832	L3	L6	L7	L17	+\$18	-	✓	✓	✓	-	✓	+\$66	+\$56	+\$70	+\$70	- ²
LPM198 ¹	\$1172	\$832	L3	L6	L7	L17	+\$18	-	✓	✓	✓	-	✓	+\$66	+\$56	+\$70	+\$70	- ²

1. LPM180 Solenoid Series - Limited Availability - Call for Pricing
 2. See IDPS Series for Door Position option

COMMAND ACCESS UNIVERSAL BATHROOM PRIVACY KIT

UBPK1-FM-EUxEL	Includes: PS220B, LPM193 Complete Lock (latch retraction EU x lever control EL), Logic Module, Illuminated Outside/Inside (Push to Open & Push to Lock) IDPS door contact, power transfer hinge, Flush mounted push buttons.	\$2450
UBPK1-FM-EUxEU	Includes: PS220B, LPM194 Complete Lock (latch retraction EU x lever control EU), Logic Module, Illuminated Outside/Inside (Push to Open & Push to Lock), IDPS door contact, power transfer hinge, Flush mounted push buttons.	\$2450
UBPK1-SM-EUxEL	Includes: PS220B, LPM193 Complete Lock (latch retraction EU x lever control EL), Logic Module, Illuminated Outside/Inside (Push to Open & Push to Lock), IDPS door contact, power transfer hinge, Surface mounted push buttons.	\$2450
UBPK1-SM-EUxEU	Includes: PS220B, LPM194 Complete Lock (latch retraction EU x lever control EU), Logic Module, Illuminated Outside/Inside (Push to Open & Push to Lock) IDPS door contact, power transfer hinge, Surface mounted push buttons.	\$2450
UBPK2-FM-EUxEL	Includes: Low Energy Operator, LPM193 Complete Lock (latch retraction EU x lever control EL), IDPS door contact, Illuminated Outside/Inside (Push to Open & Push to Lock), power transfer hinge, Flush mounted push buttons.	\$5600
UBPK2-FM-EUxEU	Includes: Low Energy Operator, LPM194 Complete Lock (latch retraction EU x lever control EU), IDPS door contact, Illuminated Outside/Inside (Push to Open & Push to Lock), power transfer hinge, Flush mounted push buttons.	\$5600
UBPK2-SM-EUxEL	Includes: Low Energy Operator, LPM193 Complete Lock (latch retraction EU x lever control EL), IDPS door contact, Illuminated Outside/Inside (Push to Open & Push to Lock), power transfer hinge, Surface mounted push buttons.	\$5600
UBPK2-SM-EUxEU	Includes: Low Energy Operator, LPM194 Complete Lock (latch retraction EU x lever control EU), IDPS door contact, Illuminated Outside/Inside (Push to Open & Push to Lock), power transfer hinge, Surface mounted push buttons.	\$5600
EME KIT ADD	Add on Emergency Annunciator Kit for UBPK	\$605

ELECTRIFIED MORTISE LOCKS

✓ or \$ = Available
 - = Not Available

PART #	LIST \$			Stock Trim Styles					Stock Finishes			Keyway		Optional Switches				
	COMPLETE LOCK List \$	CHASSIS ONLY List \$	MODIFICATION ONLY List \$	4	4	4	4	4	626	625	613	LC	SC	SFIC (less core)	LFIC (less core)	Request to Exit (REX)	Latchbolt Monitor (LBM)	Door Position (DPS)

ACCURATE

MODIFICATION ONLY (Customer's Accurate 9145/FSB 7145 Chassis)
 Specify Voltage, Fail Safe (EL) or Fail Secure (EU) and Handing.

STOREROOM	ML59EU/EL	-	-	\$165	-	-	-	-	-	-	-	-	-	-	-	+\$70	+\$70	+\$70	-
-----------	-----------	---	---	-------	---	---	---	---	---	---	---	---	---	---	---	-------	-------	-------	---

ARROW

MODIFICATION ONLY (Customer's AM17 or BM17 Chassis) - Specify EU or EL, Voltage and Handing.

FUNCTION	PART #	COM \$	CH \$	MD \$	4	4	4	4	4	626	625	613	LC	SC	SFIC	LFIC	REX	LBM	DPS	DBM
STOREROOM	ML77EU/EL	-	-	\$165	-	-	-	-	-	-	-	-	-	-	-	-	+\$70	-	-	-

BEST 45

MODIFICATION (Customer's Best 45HD, 45HAB & 45HUNAB Chassis) / CHASSIS ONLY / COMPLETE LOCK
 Specify Voltage, Fail Safe (EL) or Fail Secure (EU) and Handing. Special order trims and finishes available. Faceplates & Strikes available in 626

FUNCTION	PART #	COM \$	CH \$	MD \$	4	4	4	4	4	626	625	613	LC	SC	SFIC	LFIC	REX	LBM	DPS	DBM
STOREROOM	ML45DEU/EL	-	\$544	\$154	3H	15H	-	14H	M*	✓	✓	✓	✓	-	+\$66	-	+\$70	+\$70	+\$70	-
INSTITUTIONAL	ML45WEU/EL	-	\$544	\$170	3H	15H	-	14H	-	✓	✓	✓	✓	-	+\$132	-	+\$70	+\$70	+\$70	-
ENTRANCE W/DB	ML453DEU/EL	-	\$701	\$170	3H	15H	-	14H	-	✓	✓	✓	✓	-	+\$66	-	-	-	-	-
PRIVACY W/ DB	ML453TEU	-	\$750	\$214	3H	15H	-	14H	-	✓	✓	✓	✓	-	+\$66	-	-	-	-	-

CAL ROYAL

MODIFICATION (Customer's Cal-Royal M8080 & M8453 Chassis) / COMPLETE LOCK
 Specify Voltage, Fail Safe (EL) or Fail Secure (EU) and Handing.

FUNCTION	PART #	COM \$	CH \$	MD \$	4	4	4	4	4	626	625	613	LC	SC	SFIC	LFIC	REX	LBM	DPS	DBM
STOREROOM	ML8080EU/EL	\$694	-	\$154	TS	SS	GS	JS	-	✓	✓	✓	-	✓	+\$66	+\$28	+\$70	+\$70	-	-
ENTRANCE W/DB	ML8053EU/EL	\$743	-	\$193	TS	SS	GS	JS	-	✓	✓	✓	-	✓	+\$66	+\$28	+\$70	+\$70	-	-

CORBIN RUSSWIN

MODIFICATION (Customer's Corbin ML2057 Chassis)
 Specify Voltage, Fail Safe (EL) or Fail Secure (EU). Faceplates & Strikes available in 613, 625, 626 (see page 9 for pricing)

FUNCTION	PART #	COM \$	CH \$	MD \$	4	4	4	4	4	626	625	613	LC	SC	SFIC	LFIC	REX	LBM	DPS	DBM
STOREROOM	ML05EU/03EL	-	\$680	\$152	-	-	-	-	-	✓	CALL	CALL	✓	✓	+\$66	+\$28	+\$70	+\$70	+\$70	-
INSTITUTIONAL	ML04EU/01EL	-	\$697	\$170	-	-	-	-	-	✓	CALL	CALL	✓	✓	+\$132	+\$56	+\$70	+\$70	+\$70	-

FALCON

MODIFICATION (Customer's Falcon MA 561/31 Chassis)
 Specify Voltage, Fail Safe (EL) or Fail Secure (EU). Faceplates & Strikes available in 613, 625, 626 (see page 9 for pricing)

STOREROOM	ML81EU/51EL	-	-	\$152	SEE MRC1 SERIES FOR CHASSIS ONLY												+\$70	+\$70	-	-
INSTITUTIONAL	ML21EU/11EL	-	-	\$170													+\$70	+\$70	-	-
ENTRANCE W/DB	ML681EU/EL	-	-	\$170													+\$70	+\$70	-	-

1. Not available on deadbolt models
 2. Call for availability of deadbolt trims.



ELECTRIFIED MORTISE LOCKS



√ or \$ = Available
- = Not Available

PART #	LIST \$			Stock Trim Styles					Stock Finishes			Keyway		Optional Switches				
	COMPLETE LOCK List \$	CHASSIS ONLY List \$	MODIFICATION ONLY List \$	Call	Call	Call	Call	Call	626	625	613	S	LC	SFIC (less core)	LFIC (less core)	Request to Exit (REX)	Latchbolt Monitor (LBM)	Door Position (DPS)

SARGENT

MODIFICATION (Customer's Sargent 8237 Chassis) / CHASSIS ONLY

Specify Voltage, Fail Safe (EL) or Fail Secure (EU). Faceplates & Strikes available in 613, 625, 626 (see page 9 for pricing). Fire link is removed for LBM.

FUNCTION	PART #	COM \$	CH \$	MD \$	Call	Call	Call	Call	Call	626	625	613	LC	SC	SFIC	LFIC	REX	LBM	DPS	DBM
STOREROOM	ML371EU/70EL	-	\$830	\$152	-	-	-	-	-	✓	-	✓	✓	✓	+\$66	+\$28	+\$70	+\$70	-	-
INSTITUTIONAL	ML373EU/11EL	-	\$847	\$170	-	-	-	-	-	✓	-	✓	✓	✓	+132	+\$56	+\$70	+\$70	-	-

SCHLAGE

MODIFICATION (Customer's Schlage L9050/9070 & L9453 Chassis) / CHASSIS ONLY / COMPLETE LOCK

Specify Voltage. Faceplates & Strikes available in 613, 625, & 626. Call Factory for other finishes

FUNCTION	PART #	COM \$	CH \$	MD \$	Call	Call	Call	Call	Call	626	625	613	LC	SC	SFIC	LFIC	REX	LBM	DPS	DBM
CLASSROOM	ML70EU/EL	\$1380	\$560	\$166	03	06	Call	17	Call	✓	✓	✓	✓	✓	+\$66	+\$28	+\$70	+\$70	-	-
STOREROOM	ML80EU/EL	\$1350	\$530	\$160	03	06	Call	17	Call	✓	✓	✓	✓	✓	+\$66	+\$28	+\$70	+\$70	+\$70	+\$70
INSTITUTIONAL	ML82EU/EL	\$1410	\$540	\$170	03	06	Call	17	Call	✓	✓	✓	✓	✓	+132	+\$56	+\$70	+\$70	+\$70	+\$70
ENTRANCE W/DB	ML480EU/EL	\$1450	\$620	\$220	03	06	Call	17	Call	✓	✓	✓	✓	✓	+\$66	+\$28	+\$70	+\$70	-	+\$70
INSTITUTIONAL W/DB	ML482EU/EL	\$1500	\$630	\$230	03	06	Call	17	Call	✓	✓	✓	✓	✓	+132	+\$56	+\$70	+\$70	-	+\$70
PRIVACY w/DB	ML485EU	\$1490	\$660	\$250	03	06	Call	17	Call	✓	✓	✓	✓	✓	+\$66	+\$28	+\$70	+\$70	-	+\$70



MOTORIZED LOCKS 11-30V, Field Selectable Fail Secure/Fail Safe. Field Hand-able. LFIC = Schlage compatible housing

FUNCTION	PART #	COM \$	CH \$	MD \$	Call	Call	Call	Call	Call	626	625	613	LC	SC	SFIC	LFIC	REX	LBM	DPS	DBM
STOREROOM	ML92-M EU/EL	\$1450	\$630	\$270	03	06	07	17	L/N	✓	✓	✓	✓	✓	+\$66	+\$28	+\$70	+\$70	-	-
INSTITUTIONAL	ML95-M EU/EL	\$1510	\$640	\$280	03	06	07	17	L/N	✓	✓	✓	✓	✓	+132	+\$56	+\$70	+\$70	-	-

YALE

MODIFICATION (Customer's Yale 8808 Chassis) / CHASSIS ONLY

Specify Voltage, Fail Safe (EL) or Fail Secure (EU) and Handing. Faceplates (List \$57) & Strikes available in 626 (see page 9 for pricing). Fire link is removed for LBM.

FUNCTION	PART #	COM \$	CH \$	MD \$	Call	Call	Call	Call	Call	626	625	613	LC	SC	SFIC	LFIC	REX	LBM	DPS	DBM
STOREROOM	ML91EU/90EL	-	\$700	\$160	-	-	-	-	CALL	✓	-	-	✓	✓	+\$66	+\$28	+\$70	+\$70	-	-
INSTITUTIONAL	ML95EU/94EL	-	\$735	\$177	-	-	-	-	CALL	✓	-	-	✓	✓	+132	+\$56	+\$70	+\$70	-	-

ACCESSORIES

MORTISE LOCK SWITCH OPTIONS

REX - Request to Exit or AE switch available - sends a signal to alert the control panel that the door is about to be opened by someone intending to exit from within the secured area.

LBM - Latchbolt Monitor switch available - sends a signal to the control panel to monitor the position of the latchbolt.

DPS - Door Position switch available - sends a signal to the control panel to monitor the position of the door.

DBM - Deadbolt Monitor switch available - sends a signal to the control panel to monitor the position of the deadbolt.

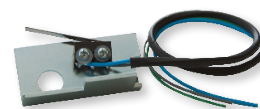

PART #	DESCRIPTION	W/ Electrification	W/O Electrification
CATREXKIT-ML ¹	Command Access ML1-series mortise lock field installable REX (Request to Exit) kit.	\$70	\$150
CATLBMKIT-ML ¹	Command Access ML1-series mortise lock field installable LBM (Latchbolt Monitor) kit	\$70	\$150
CATREXLBMKIT-ML ¹	Command Access ML/Schlage L-series mortise lock field installable LBM (Latchbolt Monitor) + REX (Request to Exit) kit	\$135	\$150
SCHREXKIT-ML ¹	Schlage L-series mortise lock field installable REX (Request to Exit) kit.	\$70	\$150
SCHREXKIT-FE-ML ²	Schlage L909x-series mortise lock field installable REX (Request to Exit) kit.	\$88	\$150
REX	Request to Exit switch installed in Mortise Lock	\$70	\$150
REXBYPASS	Request to Exit By Pass switch installed in Mortise Lock (CAT/SCH)	\$70	\$150
LBM	Latch Bolt Monitor switch installed in Mortise Lock	\$70	\$150
DPS	Door Position switch installed in Mortise Lock	\$70	\$150
DBM	Deadbolt Monitor switch installed in Mortise Lock	\$70	\$150
RXBP	Request to Exit Switch with Bypass option to shunt the signal during unlocked cycles installed in mortise lock	\$135	\$270

1. Requires the lock body to be opened for installation.

2. Only compatible with new Schlage L909x Lock Body with Cutout for REX.

ACCESSORIES & REPLACEMENT FOR MORTISE LOCKS

FACEPLATE	Storeroom or Deadbolt function in specified finishes.	\$42
STRIKE	4-7/8" ASA Strike in specified finishes	\$42
Lead Lining	Add Lead Lining to CAT or Schlage Mortise Lock	\$500
I/O Mounting Plate	Inside Only Mounting Plate for CAT/Schlage trim for less outside trim applications.	\$85
CRU	Current Reduction Unit	\$39
4' LEAD	Add 4' lead to any switch (per switch)	\$35
BR1	Bridge Rectifier w/ 12" Lead	\$18
BR5	Bridge Rectifier w/ 5' Lead	\$30
QC/CON	8-pin or 12-pin Molex Connectors added to locking device retrofit ElectroLynx or Allegion Connect	\$28
QC/CON w/ Lead 3-5'	8-pin or 12-pin Molex Connectors w/3-5' lead added to locking device retrofit ElectroLynx or Allegion Connect	\$48
QC/CON w/ Lead 10-20'	8/12-pin Molex Connectors w/ 10-20' lead added to connect a power supply directly to to QC prepped power transfer hinge	\$105
Door Cord QC/CON	3-5' Door Cord to connect a QC prepped locking device to the power transfer hinge	\$85
SOL-ML	Mortise Lock Replacement Solenoids (Specify brand, EU or EL & Voltage)	\$90

Allegion Connect® is a registered trademark of Allegion
ElectroLynx® is a registered trademark of Assa Abloy

Micro-Fit 3.0™ Interconnect System available to retrofit common quick connection systems such as ElectroLynx® or Allegion Connect®.

www.commandaccess.com | US Customer Support 888.622.2377



ELECTRIFIED CYLINDRICAL LOCK

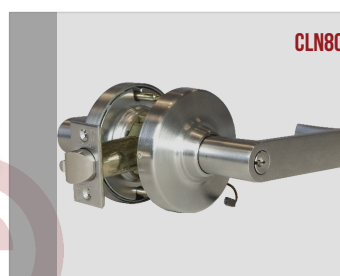
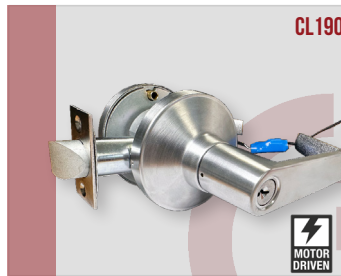
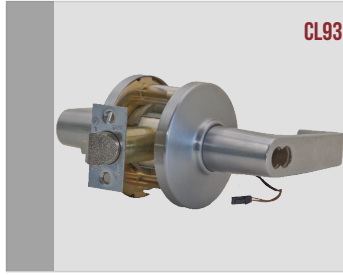

FOR MODIFICATION AND COMPLETE LOCKS

PREFIX

MD - Modification

MODEL + FUNCTION

Select a model number and add
 EL (Fail Safe) - Electronically Locked
 EU (Fail Secure) - Electronically Unlocked

VOLTAGE

12 or 24 Volts must be specified
 Motorized = Universal Input 11-30V
 LE = Universal Input 11-30V



OPTIONAL SWITCHES



REX - Request-to-Exit



FOR COMPLETE LOCKS ONLY

TRIM

 - Tubular
 - Bent

 - Straight
 - Curved

FINISH (BHMA std)

605 - Polished Bronze 625 - Polished Chrome
 613 - Oil Rubbed Bronze 626 - Satin Chrome
SPECIAL ORDER
 606 - Satin Brass 612 - Satin Bronze

KEYWAY

SC - "C" Kwy Standard SFIC - Small Format I/C Prep
 LC - Less Cylinder LFIC - Factory Large Format I/C Prep

ACCESSORIES

Strikes - 4-7/8" ASA Strike in specified finishes
 CRU2 - Current Reduction Unit (AC & DC input)
 4 Lead - 4' Wire Lead to switches
 10 Lead - 10' Wire lead to switches
 QC - Molex Connectors
 BR1 - Bridge Rectifier w/ 12" lead (included)
 BR5 - Bridge Rectifier w/ 5' lead

EXAMPLES

MODIFICATION ONLY

	PREFIX	MODEL	FUNCTION	SUFFIX	VOLTAGE	FINISH	KEYWAY	OPTIONS	ACC	COMPLETE PART #
Part #	MD	CL93D	EL	-	12V	-	-	-	CRU2	MDCL93D EL 12V CRU2
List \$	-	\$143	-	-	-	-	-	-	\$39	\$182

COMPLETE LOCK

	PREFIX	MODEL	FUNCTION	SUFFIX	VOLTAGE	FINISH	KEYWAY	OPTIONS	ACC	COMPLETE PART #
Part #	-	CL180	EU	L6	24V	626	SFIC	REX	-	CL180 EU L6 24V 626 SFIC REX
List \$	-	\$343	-	-	-	-	-	70	-	\$413



ELECTRIFIED CYLINDRICAL LOCK



COMMAND ACCESS CL1 COMPLETE LOCK

Specify Voltage. Typically Stocked Finishes - 605*, 612*, 613, 625, 626. 2-3/8" backset List \$35

FUNCTION	PART #	COM \$					626	625	613	LC	SC	SFIC	LFIC ²	REX
STOREROOM	CL180EU/EL	\$343	-	L6	L7 ³	L17	✓	✓	✓	-	✓	✓	✓	+\$70
LE STOREROOM ¹	CL180-LE EU/EL	\$428	-	L6	L7*	L17	✓	✓	✓	-	✓	✓	✓	✓

✓ or \$ = Available
- = Not Available

1. Universal input 11-30V
2. Available in L6 626 only

3. Limited availability, please call to confirm stock.
- *2-3/8" backset available list \$35

COMMAND ACCESS CL1-HD COMPLETE LOCK

Automatically senses 12v or 24v, Typically Stocked Finishes - 605*, 612*, 613, 625, 626. 2-3/8" backset List \$35

FUNCTION	PART #	COM \$					626	625	613	LC	SC	SFIC	LFIC ²	REX
MOTORIZED STOREROOM	CL190HD-M EU/EL	\$580	-	L6	L7 ³	L17	✓	✓	✓	-	✓	✓	✓	+\$70

✓ or \$ = Available
- = Not Available

COMMAND ACCESS LPC1-HD COMPLETE LOCK

1st of its kind motorized latch retraction in a cylindrical lock, 24v, Typically Stocked Finishes, backset List \$35



PATENT PENDING

FUNCTION	PART #	COM \$					626	625	613	LC	SC	SFIC	LFIC ²	REX
STOREROOM	LPC190-HD EU	\$780	-	L6	L7 ³	L17	✓	✓	✓	-	✓	✓	✓	+\$70
PASSAGE	LPC110-HD EU	\$780	-	L6	L7*	L17	✓	✓	✓	-	✓	✓	✓	✓

✓ or \$ = Available
- = Not Available

BEST

MODIFICATION (Customer's Best 93K Series) / COMPLETE LOCK

Specify Voltage. Typically Stocked Finishes - 626. C & D Roses Available

FUNCTION	PART #	COM \$	MD \$					626	625	613	LC	SC	SFIC	LFIC	REX
STOREROOM	CL93D EU/EL	\$758	\$143	-	15	-	14	✓	-	-	✓	✓	✓	-	+\$70

CAL ROYAL

MODIFICATION (Customer's Cal Royal CGN05) / COMPLETE LOCK

Specify Voltage. Typically Stocked Finishes - 613, 625, 626.

FUNCTION	PART #	COM \$	MD \$					626	625	613	L	SC	SFIC	LFIC	REX
STOREROOM CLUTCH	CLCR05 EU/EL	\$475	\$135	-	-	-	-	✓	✓	✓	✓	✓	✓	✓	+\$70

CORBIN RUSSWIN

MODIFICATION (Customer's Corbin CL3357) / COMPLETE LOCK

Specify Voltage. Typically Stocked Finishes - 613, 625, 626.

FUNCTION	PART #	COM \$	MD \$					626	625	613	LC	SC	SFIC	LFIC	REX
STOREROOM	CL05 EU	\$890	\$162	-	NZD	-	PZD	✓	-	-	✓	✓	-	✓	+\$70
STOREROOM	CL03 EL	\$890	\$162	-	NZD	-	PZD	✓	-	-	✓	✓	-	✓	+\$70

LSDA

MODIFICATION ONLY (Customer's LSDA C5400 Grade One Lock)

Specify Voltage.

FUNCTION	PART #	COM \$	MD \$					626	625	613	LC	SC	SFIC	LFIC	REX
STOREROOM CLUTCH	CLC5400 EU/EL	-	\$224	-	-	-	-	-	-	-	-	-	-	-	+\$70

MARKS

MODIFICATION ONLY (Customer's Marks 195F)
Specify Voltage.

✓ or \$ = Available
- = Not Available

FUNCTION	PART #	COM \$	MD \$	4	4	4	4	626	625	613	LC	SC	SFIC	LFIC	REX
STOREROOM	CLF95 EU/EL	-	\$168	-	-	-	-	-	-	-	-	-	-	-	+\$70

SARGENT

MODIFICATION (Customer's Sargent 10G04) / COMPLETE LOCK
Specify Voltage. Typically Stocked Finishes - 613, 625, 626. Call for availability.

FUNCTION	PART #	COM \$	MD \$	4	4	4	4	626	625	613	LC	SC	SFIC	LFIC	REX
STOREROOM	CL371 EU	\$890	\$162	-	✓	-	✓	✓	-	-	✓	✓	-	✓	+\$70
STOREROOM	CL370 EL	\$890	\$162	-	✓	-	✓	✓	-	-	✓	✓	-	✓	+\$70

SCHLAGE

MODIFICATION (Customer's Schlage ND12PD, ND70PD, ND80PD, ND94PD, ND96PD) / COMPLETE LOCK
Specify Voltage. Typically Stocked Finishes - 613, 625, 626. Classic 'C' type keyway comes standard.

FUNCTION	PART #	COM \$	MD \$	4	4	4	4	626	625	613	LC	SC	SFIC/BD	LFIC/JD	REX
EXIT	CLN12 EU/EL	-	\$123	-	-	-*	-			-	-	-	-	-	+\$70
CLASSROOM	CLN70 EU/EL	\$930	\$123	-	RHO	ATH*	SPA	✓	✓	+\$33	-\$12	✓	+\$20	✓	+\$70
STOREROOM	CLN80 EU/EL	\$930	\$123	-	RHO	ATH*	SPA	✓	✓	+\$33	-\$12	✓	+\$20	✓	+\$70
STOREROOM CLUTCH	CLN96 EU/EL	\$950	\$131	-	RHO	ATH*	SPA	✓	✓	+\$33	-\$12	✓	+\$20	✓	+\$70

Add \$35 list for Schlage original C & Everest C123.
Add \$15 list for Control key..
Add \$70 List net for RD & TD

*Athens Handle Style Only Available in PD - 626

ACCESSORIES & REPLACEMENT FOR CYLINDRICAL LOCKS

CATREXKIT-CL	REX (Request to Exit) installed on CAT CL1 spring cage field installable) kit.	\$82
SCHREXKIT-CL	Schlage ND series Anti-Rotation Plate with Request to Exit (REX) switch installed	\$82
REX	Request to Exit (REX) switch installed installed on cylindrical lock	\$70

ACCESSORIES & REPLACEMENT FOR CLYLINDRICAL LOCKS

STRIKE	Standard ASA Strike in specified finishes	\$40
CRU	Current Reduction Unit	\$39
4' LEAD	Add 4' lead to any switch (per switch)	\$35
BR1	Bridge Rectifier w/ 12" Lead	\$18
BR5	Bridge Rectifier w/ 5' Lead	\$30
QC/CON	8-pin or 12-pin Molex Connectors added to locking device retrofit ElectroLynx or Allegion Connect	\$28
QC/CON w/ Lead 3-5'	8-pin or 12-pin Molex Connectors w/3-5' lead added to locking device retrofit ElectroLynx or Allegion Connect	\$48
QC/CON w/ Lead 10-20'	8/12-pin Molex Connectors w/ 10-20' lead added to connect a power supply directly to to QC prepped power transfer hinge	\$105
Door Cord QC/CON	3-5' Door Cord to connect a QC prepped locking device to the power transfer hinge	\$85
SOL-CL	Cylindrical Lock Replacement Solenoids (Specify brand, EU or EL & Voltage) Factory replacement only	\$90

Allegion Connect® is a registered trademark of Allegion

ElectroLynx® is a registered trademark of Assa Abloy

Micro-Fit 3.0™ Interconnect System available to retrofit common quick connection systems such as ElectroLynx® or Allegion Connect®.

www.commandaccess.com | US Customer Support 888.622.2377



LATCH RETRACTION & PACKAGES

LPM190X SERIES



The LPM190X series is a **motorized latch retraction mortise** lockset that is compatible with Schlage trim and prep. Latch retraction makes it an ideal lock for pairing with auto-operators, double doors, push/pull conditions & single occupancy restroom applications. Available with lever control solenoid for latch retraction x lever control allowing for multiple specialty functions.

- Motorized Latch Retraction
- Retrofits to Schlage L9000 series
- Grade 1 UL listed
- Available with REX, LBM, & DPS
- Input voltage 24VDC
- Current Peak 1A
- Holding current 300mA
- Lever control EU/EL field changeable

PART #	COMPLETE LOCK LIST \$	CHASSIS ONLY LIST \$	IN-STOCK TRIM							IN-STOCK FINISHES			KEYWAY		OPTIONAL SWITCHES			
			L3	L6	L7	L17	B ROSE	626	625	613	LC	SC	SFIC	LFIC	REX	LBM	DPS	
LPM1910 ¹	\$983	\$673	L3	L6	L7	L17	+\$18	+\$55	✓	✓	✓	-	✓	+\$66	+\$28	+\$70	+\$70	- ²
LPM190 ¹	\$993	\$673	L3	L6	L7	L17	+\$18	+\$55	✓	✓	✓	-	✓	+\$66	+\$28	+\$70	+\$70	- ²
LPM192 ¹	\$1035	\$695	L3	L6	L7	L17	+\$18	-	✓	✓	✓	-	✓	+\$66	+\$28	+\$70	+\$70	- ²
LPM193 ¹	\$1172	\$832	L3	L6	L7	L17	+\$18	+\$55	✓	✓	✓	-	✓	+\$66	+\$28	+\$70	+\$70	- ²
LPM194 ¹	\$1172	\$832	L3	L6	L7	L17	+\$18	+\$55	✓	✓	✓	-	✓	+\$66	+\$28	+\$70	+\$70	- ²
LPM195 ¹	\$1172	\$832	L3	L6	L7	L17	+\$18	-	✓	✓	✓	-	✓	+\$66	+\$28	+\$70	+\$70	- ²
LPM196 ¹	\$1172	\$832	L3	L6	L7	L17	+\$18	-	✓	✓	✓	-	✓	+\$66	+\$28	+\$70	+\$70	- ²
LPM197 ¹	\$1172	\$832	L3	L6	L7	L17	+\$18	-	✓	✓	✓	-	✓	+\$66	+\$56	+\$70	+\$70	- ²
LPM198 ¹	\$1172	\$832	L3	L6	L7	L17	+\$18	-	✓	✓	✓	-	✓	+\$66	+\$56	+\$70	+\$70	- ²

1. LPM180 Solenoid Series - Limited Availability - Call for Pricing
 2. See IDPS Series for Door Postion option

EXAMPLES

CHASSIS ONLY

	PREFIX	MODEL	FUNCTION	SUFFIX	VOLTAGE	FINISH	KEYWAY	OPTIONS	ACC	COMPLETE PART #
Part #	-	LPM190-M	EU	CH	24V	-	-	REX LBM	-	LPM190-M EU CH REX LBM
List \$	-	\$673	-	-	-	-	-	\$140	-	\$813

COMPLETE LOCK

	PREFIX	MODEL	FUNCTION	SUFFIX	VOLTAGE	FINISH	KEYWAY	OPTIONS	ACC	COMPLETE PART #
Part #	-	LPM192-M	EU	L3B	24V	626	S		QC	LPM192-M EU L3B 24V 626 S QC
List \$	-	\$1035	-	+\$18	-	-	-		\$28	\$1081

LATCH RETRACTION & PACKAGES

LPC190-HD SERIES







PATENT PENDING

The **LPC190-HD** is a **motorized latch retraction cylindrical lockset** that is compatible with the standard 161 prep. The 1st of its kind latch retraction cylindrical makes it an ideal lock for pairing with auto-operators, double doors, push/pull conditions & single occupancy restroom applications.

- Motorized Latch Retraction
- Input voltage range - 24VDC
- Surge current – 550mA
- Holding current- 15mA
- UL listed HD Grade 1 lockset
- EU - Fail Secure Only
- Request to Exit switch optional

COMMAND ACCESS LPC1-HD COMPLETE LOCK

PATENT PENDING 1st of its kind motorized latch retraction in a cylindrical lock, 24v, Typically Stocked Finishes, backset List \$35

FUNCTION	PART #	COM \$					626	625	613	LC	SC	SFIC	LFIC ²	REX	√ or \$ = Available - = Not Available
STOREROOM	LPC190-HD EU	\$780	-	L6	L7 ³	L17	✓	✓	✓	-	✓	✓	✓	+	\$70
PASSAGE	LPC110-HD EU	\$780	-	L6	L7*	L17	✓	✓	✓	-	✓	✓	✓	✓	

EXAMPLES

COMPLETE LOCK

	PREFIX	MODEL	FUNCTION	SUFFIX	VOLTAGE	FINISH	KEYWAY	OPTIONS	ACC	COMPLETE PART #
Part #	-	LPC190-HD	EU	L6	24V	626	SFIC	REX	-	LPC190-HD EU L6 24V 626 SFIC REX
List \$	-	\$780	-	-	-	-	-	70	-	\$850





PACKAGES

COMMAND ACCESS UNIVERSAL BATHROOM PRIVACY KIT

UBPK1

Includes everything needed for a single occupancy restroom ADA accessible & secure insuring privacy. *All you need to add is low energy operator of choice.*

UBPK2

Includes everything needed for a single occupancy restroom ADA accessible & secure insuring privacy. **Includes heavy duty low energy operator.**

PERFECT SOLUTION FOR SINGLE OCCUPANCY + ADA

- PACKAGE SOLUTION INCLUDES POINT-TO-POINT WIRING DIAGRAM
- PEACE OF MIND - INCLUDES EVERYTHING YOU NEED
- UBPK2 INCLUDES OUR LOCKING HARDWARE AO W/ ON-BOARD POWER & RELAY BOARD
- TOUCHLESS PACKAGE STANDARD

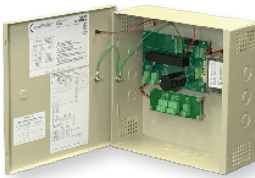

INCLUDED WITH UBPK1

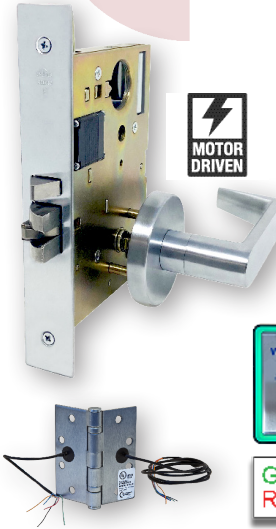

Green LED → Vacant
Red LED → Occupied

LOW ENERGY OPERATOR



INCLUDED WITH UBPK2



ADD ON EMERGENCY KIT



SEE IT IN ACTION!

UBPK1-FM-EUxEL	Includes: PS220B, LPM193 Complete Lock (latch retraction EU x lever control EL), Logic Module, Illuminated Outside/Inside (Push to Open & Push to Lock) IDPS door contact, power transfer hinge, Flush mounted push buttons.	\$2450
UBPK1-FM-EUxEU	Includes: PS220B, LPM194 Complete Lock (latch retraction EU x lever control EU), Logic Module, Illuminated Outside/Inside (Push to Open & Push to Lock), IDPS door contact, power transfer hinge, Flush mounted push buttons.	\$2450
UBPK1-SM-EUxEL	Includes: PS220B, LPM193 Complete Lock (latch retraction EU x lever control EL), Logic Module, Illuminated Outside/Inside (Push to Open & Push to Lock), IDPS door contact, power transfer hinge, Surface mounted push buttons.	\$2450
UBPK1-SM-EUxEU	Includes: PS220B, LPM194 Complete Lock (latch retraction EU x lever control EU), Logic Module, Illuminated Outside/Inside (Push to Open & Push to Lock) IDPS door contact, power transfer hinge, Surface mounted push buttons.	\$2450
UBPK2-FM-EUxEL	Includes: Low Energy Operator, LPM193 Complete Lock (latch retraction EU x lever control EL), IDPS door contact, Illuminated Outside/Inside (Push to Open & Push to Lock), power transfer hinge, Flush mounted push buttons.	\$5600
UBPK2-FM-EUxEU	Includes: Low Energy Operator, LPM194 Complete Lock (latch retraction EU x lever control EU), IDPS door contact, Illuminated Outside/Inside (Push to Open & Push to Lock), power transfer hinge, Flush mounted push buttons.	\$5600
UBPK2-SM-EUxEL	Includes: Low Energy Operator, LPM193 Complete Lock (latch retraction EU x lever control EL), IDPS door contact, Illuminated Outside/Inside (Push to Open & Push to Lock), power transfer hinge, Surface mounted push buttons.	\$5600
UBPK2-SM-EUxEU	Includes: Low Energy Operator, LPM194 Complete Lock (latch retraction EU x lever control EU), IDPS door contact, Illuminated Outside/Inside (Push to Open & Push to Lock), power transfer hinge, Surface mounted push buttons.	\$5600
EME KIT ADD	Add on Emergency Annunciator Kit for UBPK	\$605



PACKAGES

COMMAND ACCESS UNIVERSAL BATHROOM PRIVACY KIT

UBPK1

Includes everything needed for a single occupancy restroom ADA accessible & secure insuring privacy. *All you need to add is low energy operator of choice.*

UBPK2

Includes everything needed for a single occupancy restroom ADA accessible & secure insuring privacy. **Includes heavy duty low energy operator.**

PERFECT SOLUTION FOR SINGLE OCCUPANCY + ADA

- PACKAGE SOLUTION INCLUDES POINT-TO-POINT WIRING DIAGRAM
- PEACE OF MIND - INCLUDES EVERYTHING YOU NEED
- UBPK2 INCLUDES OUR LOCKING HARDWARE AO W/ ON-BOARD POWER & RELAY BOARD
- TOUCHLESS PACKAGE STANDARD

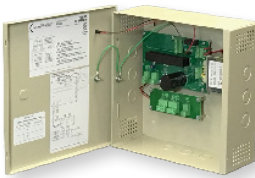

INCLUDED WITH UBPK1



MOTOR DRIVEN

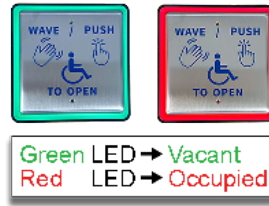

Green LED → Vacant
Red LED → Occupied

LOW ENERGY OPERATOR



INCLUDED WITH UBPK2



IN THE EVENT OF AN EMERGENCY PUSH EMERGENCY BUTTON AND AUDIBLE AND VISUAL SIGNAL WILL ACTIVATE

ADD ON EMERGENCY KIT



SEE IT IN ACTION!

UBPK1-FM-EUxEL	Includes: PS220B, LPC190-HD Complete Lock (latch retraction EU x lever control EL), Logic Module, Illuminated Outside/Inside (Push to Open & Push to Lock) IDPS door contact, power transfer hinge, Flush mounted push buttons.	\$2450
UBPK1-FM-EUxEU	Includes: PS220B, LPC190-HD Complete Lock (latch retraction EU x lever control EU), Logic Module, Illuminated Outside/Inside (Push to Open & Push to Lock), IDPS door contact, power transfer hinge, Flush mounted push buttons.	\$2450
UBPK1-SM-EUxEL	Includes: PS220B, LPC190-HD Complete Lock (latch retraction EU x lever control EL), Logic Module, Illuminated Outside/Inside (Push to Open & Push to Lock), IDPS door contact, power transfer hinge, Surface mounted push buttons.	\$2450
UBPK1-SM-EUxEU	Includes: PS220B, LPC190-HD Complete Lock (latch retraction EU x lever control EU), Logic Module, Illuminated Outside/Inside (Push to Open & Push to Lock) IDPS door contact, power transfer hinge, Surface mounted push buttons.	\$2450
UBPK2-FM-EUxEL	Includes: Low Energy Operator, LPC190-HD Complete Lock (latch retraction EU x lever control EL), IDPS door contact, Illuminated Outside/Inside (Push to Open & Push to Lock), power transfer hinge, Flush mounted push buttons.	\$5600
UBPK2-FM-EUxEU	Includes: Low Energy Operator, LPC190-HD Complete Lock (latch retraction EU x lever control EU), IDPS door contact, Illuminated Outside/Inside (Push to Open & Push to Lock), power transfer hinge, Flush mounted push buttons.	\$5600
UBPK2-SM-EUxEL	Includes: Low Energy Operator, LPC190-HD Complete Lock (latch retraction EU x lever control EL), IDPS door contact, Illuminated Outside/Inside (Push to Open & Push to Lock), power transfer hinge, Surface mounted push buttons.	\$5600
UBPK2-SM-EUxEU	Includes: Low Energy Operator, LPC190-HD Complete Lock (latch retraction EU x lever control EU), IDPS door contact, Illuminated Outside/Inside (Push to Open & Push to Lock), power transfer hinge, Surface mounted push buttons.	\$5600
EME KIT ADD	Add on Emergency Annunciator Kit for UBPK	\$605



ELECTRIFIED EXIT TRIM

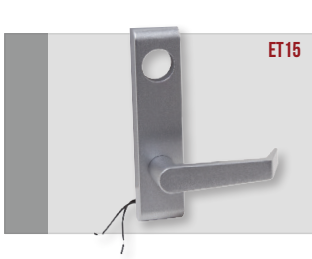

FOR MODIFICATION AND COMPLETE TRIM

PREFIX
MD - Modification

MODEL + FUNCTION
Select a model number and add
EL (Fail Safe) - Electronically Locked
EU (Fail Secure) - Electronically Unlocked

VOLTAGE
12 or 24 Volts must be specified
Motorized = Universal Input 11-30V
LE = Universal Input 11-30V

OPTIONAL SWITCHES
REE-Request-to-Enter

FOR COMPLETE TRIM ONLY

TRIM

- Tubular - Straight
 - Bent - Curved

FINISH (BHMA std)
626 - Satin Chrome
SPECIAL ORDER
613 - Oil Rubbed Bronze 625 - Polished Chrome

KEYWAY
Only ET15/25 have cylinder provided.
Rim Cylinder - "C" Standard
LC - Less Cylinder

ACCESSORIES
CRU2 - Current Reduction Unit (AC & DC input)
4 Lead - 4' Wire Lead to switches
10 Lead - 10' Wire lead to switches
QC - Molex Connectors
BR5 - Bridge Rectifier w/ 5' lead

EXAMPLES

MODIFICATION ONLY

	PREFIX	MODEL	FUNCTION	SUFFIX	VOLTAGE	FINISH	KEYWAY	OPTIONS	ACC	COMPLETE PART #
Part #	MD	MDCR22	EL	-	12V	-	-	-	CRU2	MDCR22 EL 12V CRU2
List \$	-	\$234	-	-	-	-	-	-	\$39	\$273

COMPLETE EXIT TRIM



	PREFIX	MODEL	FUNCTION	SUFFIX	VOLTAGE	FINISH	KEYWAY	OPTIONS	ACC	COMPLETE PART #
Part #	-	V96	EU	06	24V	626	-	REE	-	V96 EU 06 24V 626 REE
List \$	-	\$975	-	-	-	-	-	\$70	-	\$1045



ELECTRIFIED EXIT TRIM

COMMAND ACCESS ET15/16 SERIES

Specify EU or EL & Handing.

	COMPLETE LOCK List \$		628	313	C	Request to Enter (REE)
PART #	COMPLETE LOCK List \$		628	313	C	Request to Enter (REE)





ET15/16 for: Command Access PD15 Jackson 1285/95 AHT 8000/9000

ET15RIM EU/EL	\$525	L6	✓	✓	✓	+\$70
ET15CVR EU/EL	\$525	L6	✓	✓	✓	+\$70
ET16 RIM	\$310	L6	✓	✓	✓	+\$70
ET16 CVR	\$310	L6	✓	✓	✓	+\$70

COMMAND ACCESS ET25/26 SERIES

Command Access PD25/26, Cal Royal 7700 R/SVR, Marks M9000 & Von Duprin 98/99 R/V series

Specify EU or EL & Handing.





	COMPLETE LOCK List \$			626	613	C	IC	Request to Enter (REE)
PART #	COMPLETE LOCK List \$			626	613	C	IC	Request to Enter (REE)

ET25/26 for: Von Duprin 98/99 Command Access PD25 Cal-Royal 77

ET25 EU/EL	\$550	L6	L17	✓	+\$30	✓	+\$66	+\$70
ET25-LE EU/EL	\$635	L6	L17	✓	+\$30	✓	+\$66	✓
ET26 ELT	\$320	L6	L17	✓	+\$30	✓	+\$66	+\$70
ET26 SLT	\$320	L6	L17	✓	+\$30	✓	+\$66	+\$70
ET26 PLT	\$320	L6	L17	✓	+\$30	-	-	+\$70
ET26 DLT	\$320	L6	L17	✓	+\$30	-	-	-
ET26 NPT	\$245	-	-	✓	+\$30	✓	+\$66	-
ET26 DPT	\$235	-	-	✓	+\$30	-	-	-

COMMAND ACCESS ET27/28 SERIES -

motorized lever control - heavy duty exit trim for the CAT PD27/28 series exit device and Detex Advantex series. Also, works with Von Duprin 99/98, Marks M9900, and more with slight modifications.

	COMPLETE LOCK List \$			626	613	*C	Request to Enter (REE)
PART #	COMPLETE LOCK List \$			626	613	*C	Request to Enter (REE)

ET27-M EU/EL	\$700	L6	L17	✓	+\$30	✓	+\$70
ET28 ELT	\$450	L6	L17	✓	+\$30	✓	+\$70
ET28 SLT	\$450	L6	L17	✓	+\$30	✓	+\$70
ET28 PLT	\$430	L6	L17	✓	+\$30	-	+\$70
ET28 DLT	\$430	L6	L17	✓	+\$30	-	-
ET28 NPT	\$200	-	-	✓	+\$30	✓	-
ET28 DPT	\$186	-	-	✓	+\$30	-	-

Command Access is not a licensee or affiliated, associated or connected with Allegion, Assa Abloy, Dorma, Stanley Security, Adams Rite, Arrow, Corbin Russwin, Mckinney, Pemko, Rixson, Sargent, Yale, Dor-O-matic, Falcon, Ives, Monarch, Schlage, Von Duprin, Best, Precision, Accurate, AHT, Baldwin, Bommer, Cal Royal, CR Laurence, Design Hardware, Emtek, First Choice, FSB, General Lock, Hager, Jackson, Keedex, Lawrence, LSDA, Marks, Marshal-Best, Molex, Omnia, PBB, PDQ, or any of their subsidiaries or affiliates.



✓ or \$ = Available
 - = Not Available

Specify EU or EL, Voltage and Handing.

PART #	EXIT TRIM	COMPLETE LOCK List \$	MODIFICATION ONLY List \$ (add prefix MD)			626	LC	MAINTAIN KEY OVERRIDE	Request to Enter (REE)
CR22E U/EL	CAL ROYAL NESC 2200 R/SVR SERIES	-	\$234	-	-	-	-	✓	-
CR77 EU/EL	CAL ROYAL NESC 7700 R/SVR SERIES	-	\$234	-	-	-	-	✓	+\$70
CR98E U/EL	CAL ROYAL NESC 9800 R/SVR SERIES	-	\$234	-	-	-	-	✓	-
FAL581EU/51EL	FALCON 510 SERIES	-	\$300	-	-	-	-	✓	+\$70
H45CE EU/EL	HAGER 45CE SERIES	-	\$234	-	-	-	-	✓	-
SGT700EU/EL	SARGENT 713 SERIES	-	\$400	-	-	-	-	✓	+\$70
V23EU/EL	VON DUPRIN 230L SERIES	\$756	\$234	06	-	✓	✓	✓	-
V36EU/EL*	VON DUPRIN 360L/BE/T SERIES	-	\$518	-	-	-	-	-	-
V96EU/EL	VON DUPRIN 996L R/V & M SERIES	\$975	\$200	06	17	✓	✓	✓	+\$70

*NOTE: V36 DO NOT MAINTAIN KEY OVERRIDE- A DUMMY CYLINDER WILL BE ADDED TO ALL CYLINDER PREP TRIMS.

ACCESSORIES & REPLACEMENTS FOR EXIT TRIM

VDREEKIT-ET	Field installable Request to Enter kit for the Von Duprin 996L Series	\$82
SGTREEKIT-ET	Field installable Request to Enter kit for the Sargent 713 Series	\$82
CRU	Current Reduction Unit	\$39
4' LEAD	Add 4' lead to any switch (per switch)	\$35
10' LEAD	Add 10' lead to any switch (per switch)	\$36
BR5	Bridge Rectifier w/ 5' Lead	\$30
QC/CON	8-pin or 12-pin Molex Connectors added to locking device retrofit ElectroLynx or Allegion Connect	\$28
QC/CON w/ lead	8-pin or 12-pin Molex Connectors w/3-5' lead added to locking device retrofit ElectroLynx or Allegion Connect	\$48
QC/CON w/ Lead	8/12-pin Molex Connectors w/ 10-20' lead added to connect a power supply directly to QC prepped power transfer hinge	\$105
Door Cord QC/CON	3-5' Door Cord to connect a QC prepped locking device to the power transfer hinge	\$85
SOL-ET	Exit Trim Lock Replacement Solenoids (Specify brand, EU or EL & Voltage) - Call Factory to confirm field swap is available	\$90



ELECTRIFIED LATCH RETRACTION KITS

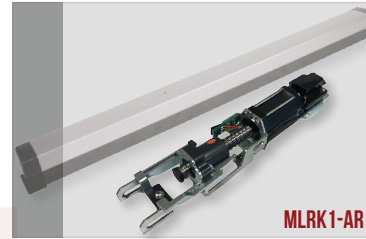
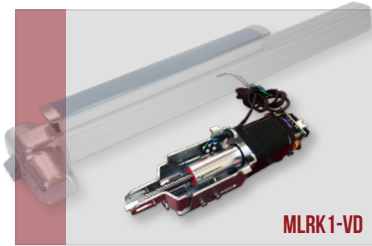
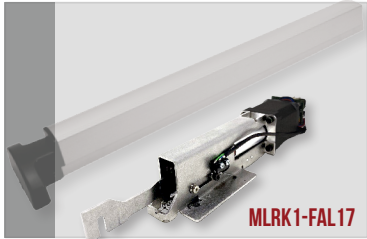

HOW TO ORDER

	MODEL	MANUFACTURER	OPTIONS	COMPLETE PART #
Part #	MLRK1	VD	REX	MLRK1-VD
List \$	\$575	-	N/C	\$575
Part #	MLRK1	AR	REX	MLRK1-AR REX
List \$	\$575	-	\$70	\$645

MOTORIZED LATCH RETRACTION KITS

ALL 24V & Fail Secure (EU) ONLY

Kits work on all style devices: RIM, SVR, CVR, & Mortise.



BUILT-IN
REX

REXKIT
AVAILABLE¹

✓ or \$ = Available
- = Not Available

PART #	EXIT DEVICE	LIST	BUILT-IN REX	REXKIT AVAILABLE ¹
MLRK1-AR	ADAMS RITE 82/84/86/88 SERIES	\$575	+\$70	\$82
MLRK1-AREX	ADAMS RITE EX SERIES	\$575	+\$70	\$82
MLRK1-ARW	Arrow 1000 series	\$575	-	\$82
MLRK1-CAL	CAL ROYAL 22 & 98 SERIES	\$575	-	\$82
MLRK1-CAL77	Cal Royal 7700 series	\$575	+\$70	\$82
MLRK1-COR	CORBIN RUSSWIN 4000/5000	\$575	+\$70	\$82
MLRK1-MRK	Design Hardware 1000	\$575	+\$70	\$82
MLRK1-DRX	DOREX 9500 SERIES	\$575	-	\$82
MLRK1-DOR	DORMA 9000 SERIES	\$575	-	\$82
MLRK1-FAL17	Falcon 16/17 & First Choice 36/37 Series	\$575	✓	\$82
MLRK1-DTX	Detex Advantex & Value Series	\$575	-	\$82

1. See page 21 for REXKIT's available & part #. Order REX Kit separately.

www.commandaccess.com | US Customer Support 888.622.2377

PART #	EXIT DEVICE	LIST	BUILT-IN	REXKIT
			REX	AVAILABLE ¹
MLRK1-FAL25	Falcon 24/25 series	\$575	✓	\$82
MLRK1-HAG	Hager 4500/4600 series	\$575	+\$70	\$82
MLRK1-JAC12	Jackson 1285/1295 SERIES	\$575	+\$70	\$82
MLRK1-JAC12	Kawneer 1686/1786 SERIES	\$575	+\$70	\$82
MLRK1-KAWP	Kawneer Paneline SERIES	\$600	+\$70	\$82
MLRK1-MBS	Marshall Best Q1/2000 SERIES	\$575	+\$70	\$82
MLRK1-MRK	Marks M9900 SERIES	\$575	+\$70	\$82
MLRK1-MRK8	Marks M8800 SERIES	\$575	+\$70	\$82
MLRK1-PDQ	PDQ 6200 SERIES	\$575	+\$70	\$82
MLRK1-PDQ63	PDQ 63/6400 SERIES	\$575	+\$70	\$82
MLRK1-PHI	PHILADELPHIA HARDWARE 9000 SERIES	\$575	+\$70	\$82
MLRK1-SGT	Sargent 80 SERIES	\$575	-	\$82
MLRK1-SQ	Stanley QED 100/200	\$575	-	\$82
MLRK1-TEL	TELL 9500 SERIES	\$575	+\$70	\$82
MLRK1-TS1	Townsteel 1000 SERIES	\$575	+\$70	\$82
MLRK1-TS2	Townsteel 9700 SERIES	\$575	+\$70	\$82
MLRK1-VD22	Von Duprin 22 SERIES	\$575	✓	\$82
MLRK1-VD	Von Duprin 33/35 & 98/99 SERIES	\$575	✓	\$82
MLRK1-VDAX	Von Duprin 33/35 & 98/99 AX SERIES	\$575	✓	\$82
MLRK1-COR	YALE 7000 SERIES	\$575	+\$70	\$82
MLRK1-YAL6	YALE 6000 SERIES	\$575	+\$70	\$82

✓ or \$ = Available
- = Not Available

1. See page 21 for REXKIT's available & part #. Order REX Kit separately.

SOLENOID LATCH RETRACTION KITS

PART #	EXIT DEVICE	LIST	REXKIT
			AVAILABLE
ARLP88-KIT	Adams Rite 8800 series	\$236	\$82
VLP-UL-KIT	Von Duprin 33/35 & 98/99 series	\$454	\$82

Command Access is not a licensee or affiliated, associated or connected with Allegion, Assa Abloy, Dorma, Stanley Security, Adams Rite, Arrow, Corbin Russwin, Mckinney, Pemko, Rixson, Sargent, Yale, Dor-O-matic, Falcon, Ives, Monarch, Schlage, Von Duprin, Best, Precision, Accurate, AHT, Baldwin, Bommer, Cal Royal, CR Laurence, Design Hardware, Emtek, First Choice, FSB, General Lock, Hager, Jackson, Keedex, Lawrence, LSDA, Marks, Marshal-Best, Molex, Omnia, PBB, PDQ, or any of their subsidiaries or affiliates.



ELECTRIFIED EXIT DEVICES



FOR MODIFICATION AND COMPLETE DEVICE

PREFIX MD - Modification
MODEL + FUNCTION Select a model number and add EU (Fail Secure) - Electronically Unlocked only
VOLTAGE 24 Volts 12 Volts - Adams Rite 88 & PD18-RIM ONLY
OPTIONAL SWITCHES REX - Request-to-Exit LBM - Latchbolt Monitor

FOR COMPLETE DEVICE ONLY

SIZE (Width of device) 36 - 36" wide device 42 - 42" wide device 48 - 48" wide device						
FINISH <table border="0" style="width: 100%;"> <tr> <td style="width: 50%;">ARCHITECTURAL</td> <td style="width: 50%;">STOREFRONT</td> </tr> <tr> <td>626 - Satin Chrome</td> <td>628 - Aluminum</td> </tr> <tr> <td>613 - Oil Rubbed Bronze</td> <td>313 - Duronatic</td> </tr> </table>	ARCHITECTURAL	STOREFRONT	626 - Satin Chrome	628 - Aluminum	613 - Oil Rubbed Bronze	313 - Duronatic
ARCHITECTURAL	STOREFRONT					
626 - Satin Chrome	628 - Aluminum					
613 - Oil Rubbed Bronze	313 - Duronatic					
ACCESSORIES 3' Lead - 3' Wire Lead w/ connector(s) 4' Lead - 4' Wire Lead w/ connector(s) QC - Molex Connectors						

EXAMPLES

KEY: MD = MODIFICATION
M = MOTOR DRIVEN

MODIFICATION ONLY - SOLENOID DRIVEN

	PREFIX	MODEL	SUFFIX	FUNCTION	VOLTAGE	SIZE	FINISH	OPTIONS	COMPLETE PART #
Part #	MD	MDARLP86	-	EU	24V	-	-	REX	MDARLP86-EU-24V REX
List \$	-	\$450	-	-	-	-	-	\$70	\$520

COMPLETE MOTOR DRIVEN DEVICE

	PREFIX	MODEL	SUFFIX	FUNCTION	VOLTAGE	SIZE	FINISH	OPTIONS	COMPLETE PART #
Part #	-	PD25	M	EU	24V	36	626	REX	PD25-M-RIM-36-626 REX
List \$	-	\$1324	-	-	-	-	-	\$70	\$1394

PD10 / PD11

STOREFRONT COMPLETE DEVICES

PD10 / PD11 Series retrofits Doromatic 1600/1700 & First Choice 3600/3700.

√ or \$ = Available
- = Not Available

PART #	FUNCTION	LIST \$	36"	*42"	48"	ALUM	DURO	REX	LBM	EXT RODS
PD10-M-RIM	Motorized Latch Retraction (EU)	\$914	✓	+\$70	+\$30	✓	+\$10	+\$70	+\$70	+\$64
PD10-M-CVR	Motorized Latch Retraction (EU)	\$934	✓	+\$70	+\$30	✓	+\$10	+\$70	-	+\$64
PD11-RIM	Mechanical RIM Device	\$470	✓	+\$70	+\$30	✓	+\$10	+\$70	+\$70	+\$64
PD11-CVR	Mechanical CVR Device	\$510	✓	+\$70	+\$30	✓	+\$10	+\$70	-	+\$64

*48" Device mechanics can be relocated at factory for 42" or speciality size for field cut down.

PD15 / PD16

COMPLETE DEVICE - PD15 / PD16 retrofits Jackson 1200 & AHT 8000/9000. Please Specify Handing for CVR.

PART #	FUNCTION	LIST \$	36"	42"*	48"	ALUM	DURO	REX	LBM	EXT RODS
PD15-M-RIM	Motorized Latch Retraction (EU)	\$930	✓	-	+\$10	✓	+\$10	+\$70	-	+\$64
PD15-M-CVR	Motorized Latch Retraction (EU)	\$970	✓	-	+\$10	✓	+\$10	+\$70	-	+\$64
PD16-RIM	Mechanical RIM Device	\$460	✓	-	+\$10	✓	+\$10	+\$70	-	+\$64
PD16-CVR	Mechanical CVR Device	\$480	✓	-	+\$10	✓	+\$10	+\$70	-	+\$64

*48" Device mechanics can be cut down to 42" in the field.

PD18 / PD19

COMPLETE DEVICE - PD18 / PD19 retrofits Adams Rite 8800 & 8600 series.

PART #	FUNCTION	LIST \$	36"	42"	48"	ALUM	DURO	REX	LBM	EXT RODS
PD18-RIM*	Solenoid Latch Retraction (EU)	\$660	✓	-	+\$30	✓	+\$10	+\$70	-	-
PD18-CVR	Solenoid Latch Retraction (EU)	\$960	✓	-	+\$30	✓	+\$10	+\$70	-	-
PD18-M-RIM	Motorized Latch Retraction (EU)	\$916	✓	-	+\$30	✓	+\$10	+\$70		
PD18-M-CVR	Motorized Latch Retraction (EU)	\$1070	✓	-	+\$30	✓	+\$10	+\$70		
PD19-RIM	Mechanical RIM Device	\$460	✓	-	+\$30	✓	+\$10	+\$70	-	-
PD19-CVR	Mechanical CVR Device	\$540	✓	-	+\$30	✓	+\$10	+\$70	-	-

PD25/26

COMPLETE DEVICE - PD25 / PD26 Series retrofits Cal Royal 7700 & Von Duprin 98/99 RIM & SVR.

PART #	FUNCTION	LIST \$	36"	42"	48"	626	613	REX	LBM	EXT RODS
PD25-M-RIM	Motorized Latch Retraction (EU)	\$1324	✓	-	+\$40	✓	+\$75	+\$70	+\$70	-
PD25-M-SVR	Motorized Latch Retraction (EU)	\$1750	✓	-	+\$40	✓	+\$75	+\$70	-	+\$95
PD25F-M-RIM	Motorized Latch Retraction (EU) -Fire Rated	\$1640	✓	-	+\$40	✓	+\$75	+\$70	+\$70	-
PD25F-M-SVR	Motorized Latch Retraction (EU) -Fire Rated	\$2066	✓	-	+\$40	✓	+\$75	+\$70	-	+\$95
PD26-RIM	Mechanical RIM Device	\$768	✓	-	+\$40	✓	+\$75	+\$70	+\$70	-
PD26-SVR	Mechanical SVR Device	\$1203	✓	-	+\$40	✓	+\$75	+\$70	-	+\$95
PD26F-RIM	Mechanical RIM Device - Fire Rated	\$1084	✓	-	+\$40	✓	+\$75	+\$70	+\$70	-
PD26F-SVR	Mechanical SVR Device - Fire Rated	\$1519	✓	-	+\$40	✓	+\$75	+\$70	-	+\$95

- Auxiliary Fire Bolt List \$95

Command Access is not a licensee or affiliated, associated or connected with Allegion, Assa Abloy, Dorma, Stanley Security, Adams Rite, Arrow, Corbin Russwin, Mckinney, Pemko, Rixson, Sargent, Yale, Dor-O-matic, Falcon, Ives, Monarch, Schlage, Von Duprin, Best, Precision, Accurate, AHT, Baldwin, Bommer, Cal Royal, CR Laurence, Design Hardware, Emtek, First Choice, FSB, General Lock, Hager, Jackson, Keedex, Lawrence, LSDA, Marks, Marshal-Best, Molex, Omnia, PBB, PDQ, or any of their subsidiaries or affiliates.



ELECTRIFIED EXIT DEVICES

PD27/28 COMPLETE DEVICE - Wide Stile

PART #	FUNCTION	LIST \$	36"	42"	48"	626	613	FIRE RATED	REX	LBM	EXT RODS
PD27-M-RIM	Motorized Latch Retraction (EU)	\$1492	✓	-	+\$40	✓	+\$75	+\$100	+\$70	+\$70	-
PD27-M-SVR	Motorized Latch Retraction (EU)	\$1878	✓	-	+\$40	✓	+\$75	+\$100	+\$70	-	+\$95
PD28-RIM	Mechanical RIM Device	\$982	✓	-	+\$40	✓	+\$75	+\$100	+\$70	+\$70	-
PD28-SVR	Mechanical SVR Device	\$1368	✓	-	+\$40	✓	+\$75	+\$100	+\$70	-	+\$95

PD29/30 COMPLETE DEVICE - Narrow Stile

PD29-M-RIM	Motorized Latch Retraction (EU)	\$1504	✓	-	+\$40	✓	+\$75	+\$100	+\$70	+\$70	-
PD29-M-SVR	Motorized Latch Retraction (EU)	\$1978	✓	-	+\$40	✓	+\$75	+\$100	+\$70	-	+\$95
PD30-RIM	Mechanical RIM Device	\$994	✓	-	+\$40	✓	+\$75	+\$100	+\$70	+\$70	-
PD30-SVR	Mechanical SVR Device	\$1468	✓	-	+\$40	✓	+\$75	+\$100	+\$70	-	+\$95

ADAMS RITE MODIFICATION (Customer's Adams Rite 8000 Series Devices) - Maintains factory dogging ability.

PART #	FUNCTION	LIST \$	REX	LBM
MDARLP82	Solenoid Latch Retraction (EU)	\$450	+\$70	-
MDARLP84	Solenoid Latch Retraction (EU)	\$450	+\$70	-
MDARLP86	Solenoid Latch Retraction (EU)	\$450	+\$70	-
MDARLP88*	Solenoid Latch Retraction (EU)	\$255	+\$70	-

*Available in 12V or 24V. Please specify when ordering

ACCESSORIES & REPLACEMENT FOR EXIT DEVICES

PART #	FUNCTION	LIST \$
8' Lead	8' Power Lead for Exit Devices	\$35
10' LEAD	Add 10' lead to any switch (per switch)	\$36
QC/CON	8-pin or 12-pin Molex Connectors added to locking device retrofit ElectroLynx or Allegion Connect	\$28
QC/CON w/ lead	8-pin or 12-pin Molex Connectors w/3-5' lead added to locking device retrofit ElectroLynx or Allegion Connect	\$48
QC/CON w/ Lead	8/12-pin Molex Connectors w/ 10-20' lead added to connect a power supply directly to to QC prepped power transfer hinge	\$105
Door Cord QC/CON	3-5' Door Cord to connect a QC prepped locking device to the power transfer hinge	\$85
50944	Motor Molex Power Lead 12" - Plugs directly into our MM modules	\$20
SOL-LP1	Replacement Solenoid Assembly for Electrified Latch Retraction - Single Coil	\$135
SOL-LP2	Replacement Solenoid Assembly for Electrified Latch Retraction - Dual Coil	\$135
SOL-LP3	Replacement Solenoid Assembly for Electrified Latch Retraction - Single Coil (12EU ARLP88)	\$135
SOL-LP4	Replacement Solenoid Assembly for Electrified Latch Retraction - Two-Solenoid Assembly	\$223
SOL-LP5	Replacement Solenoid Assembly for Electrified Latch Retraction - Single Coil (24EU ARLP88)	\$135

NOTES* See website for specific applications. ElectroLynx® is a registered trademark of Assa Abloy

ElectroLynx® is a registered trademark of Assa Abloy

Allegion Connect® is a registered trademark of Allegion

Micro-Fit 3.0™ Interconnect System available to retrofit common quick connection systems such as ElectroLynx® or Allegion Connect®.

www.commandaccess.com | US Customer Support 888.622.2377



EXIT DEVICE SWITCH OPTIONS

PART #	FUNCTION	LIST \$
REX	Add Request to Exit Switch to device	\$70
LBM	Add Latchbolt Monitor Switch to device	\$70
REX2	Add Double Request to Exit Switch to device	\$160

* Call Factory for specific device availability

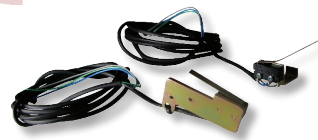

Switch Kit List \$	Mechanical Device	Solenoid Device	Motorized Device
--------------------	-------------------	-----------------	------------------

SWITCH FIELD KITS FOR EXIT DEVICES

Part #	Function	Switch Kit List \$	Mechanical Device	Solenoid Device	Motorized Device
ARREXKIT-ED	Field Installable Request to Exit Kit for Adams Rite 8000 Series	\$82	✓	✓	-
ARREXKIT2-ED	Field Installable Double Request to Exit Kit for Adams Rite 8000 Series	\$160	✓	✓	-
ARREXKIT-M-ED	Field Installable Request to Exit Kit for MRLK1 Adams Rite Series	\$82	-	-	✓
CRSREXKIT-ED	Field Installable Request to Exit Kit for Cal Royal 22/98 & Sargent 80 Series	\$82	✓	-	✓
CYREXKIT-ED	Field Installable Request to Exit Kit for Corbin 4/5000 & Yale 7000 Series	\$82	✓	-	-
CYREXKIT-M-ED	Field Installable Request to Exit Kit for MRLK1 Corbin & Yale Series	\$82	-	-	✓
ED1REXKIT-M-ED	Field Installable Request to Exit Kit for MRLK1 Philadelphia & Tell Series	\$82	-	-	✓
ED2REXKIT-M-ED	Field Installable Request to Exit Kit for MRLK1 Series LSDA9200, USCAN2100, & Townsteel 1000 Series	\$82	-	-	✓
DORREXKIT-ED	Field Installable Request to Exit Kit for Dorma 9000 series	\$82	✓	✓	✓
MRKREXKIT-M-ED	Field Installable Request to Exit Kit for MRLK1-MRK Marks M9900/8800 & Design Hardware Series-	\$82	-	-	✓
LLPREXKIT-M-ED	Field Installable Request to Exit Kit for MRLK1-Hager, LSDA9000, Lawrence, PDQ Series	\$82	-	-	✓
PD10REXKIT-ED	Field Installable Request to Exit Kit for Falcon 16/17 & First Choice 36/37 Series	\$82	✓	✓	✓
PD15REXKIT-ED	Field Installable Request to Exit Kit for Jackson 1285/95 & Kawneer 16/17 Series	\$82	✓	-	-
PD15REXKIT-M-ED	Field Installable Request to Exit Kit for MRLK1 Jackson & Kawneer Series -	\$82	-	-	✓
PD25REXKIT-ED	Field Installable Request to Exit Kit for PD25/26 & Cal Royal 7700 Series	\$82	✓	-	✓
PREREXKIT-ED	Field Installable Request to Exit Kit for Precision 2000 Series	\$82	✓	✓	-
VDREXKIT-ED	Field Installable Request to Exit Kit for Von Duprin 99/98 & 35/33 Series	\$82	✓	✓	✓
VDREXKIT-LC-ED	Field Installable Low Energy Request to Exit Kit for Von Duprin 99/98 & 35/33 Series	\$92	✓	✓	✓
VDREXKIT2-ED	Field Installable Double Request to Exit Kit for Von Duprin 99/98 & 35/33 Series	\$160	✓	✓	✓
VDLBMKIT-ED	Field Installable Latchbolt Monitor Kit for Von Duprin 99/98 & 35/33 Series	\$82	✓	✓	✓
YAL6REXKIT-ED	Field Installable Request to Exit Kit for Yale 6000 Series	\$82	✓	-	-
YAL6REXKIT-M-ED	Field Installable Request to Exit Kit for MRLK1 Yale 6000 Series- MRLK1-YAL6 Series	\$82	-	-	✓



POWER SUPPLIES

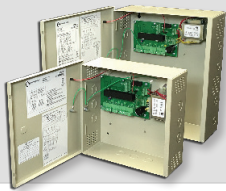

UL294 6TH EDITION LISTING

PS210		PS204/204B
PS220/220B		
PS440B		
PS480B		

POWER SUPPLIES FOR ALL LATCH PULLBACK/EXIT DEVICES

PS210	1.5A, 24V regulated PS w/boost circuitry for up to (2) electric latch pullback devices. Includes (1) solid state input/output	\$310
PS220	2A, 24V regulated PS w/boost circuitry for up to (2) electric latch pullback devices. Includes (2) solid state inputs/outputs and a fire alarm link. (1) 24VDC Power Tap	\$375
PS220B	2A, 24V regulated PS w/boost circuitry for up to (2) electric latch pullback devices. Includes (2) solid state inputs/outputs, battery charging circuit, and a fire alarm link. (1) 24VDC Power Tap. Battery Back-up	\$440
PS440B	4A, 24V regulated PS w/boost circuitry is capable of powering up to (4) electric latch pullback devices. Includes (4) solid state inputs/outputs, battery charging circuit, and a fire alarm link. Battery Back-up	\$495
PS480B	4A, 24V regulated PS w/boost circuitry for up to (8) electric latch pullback devices. Includes (8) solid state inputs/outputs, battery charging circuit, and a fire alarm link. Battery Back-up	\$541

POWER SUPPLIES FOR MOTORIZED LATCH RETRACTION, MORTISE/CYLINDRICAL LOCK, & EXIT TRIM

PS204	2A, 24V regulated PS w/boost circuitry for up to (4) MOTORIZED electric latch pullback devices. Includes (4) solid state inputs/outputs, and a fire alarm link	\$352
PS204B	2A, 24V regulated PS w/boost circuitry for up to (4) MOTORIZED electric latch pullback devices. Includes (4) solid state inputs/outputs, and a fire alarm link. Battery Back-up	\$400

POWER SUPPLIES & AUXILIARY BOARDS

PS1-B0	Board Only to replace PS1 - 1A, 24V regulated power supply	\$244
PS-OP-2	Replacement Relay Board for PS202/202B/220/220B (Specify Series)	\$207
PS-OP-4	Replacement Relay Board for PS204/204B/440B (Specify Series)	\$218
PS-OP-8	Replacement Relay Board for PS480B	\$230
SW3	2.4A 27VDC regulated power supply w/ (3) non-fused outputs for electric strikes, mortise locks and cylindrical locks. **NOT UL**	\$200
BB12V7	Set of (2) 12VDC 7AH Batteries for Power Supplies with Battery Back-Up	\$160
CAMLCK-PS	Cam Lock For Command Power Supplies	\$20



LOCKING HARDWARE AUTO-OPERATOR

Heavy Duty Auto-Operator - On-Board door sequencing, Push To Learn, & locking hardware power tap.

CATHD0100-PUSH	Command Heavy Duty Locking Hardware Auto-Operator 39" -Alum/Duro/Black - Push Arm - Handing Reversible	\$3600
CATHD0100-PULL	Command Heavy Duty Locking Hardware Auto-Operator 39" -Alum/Duro/Black - Pull Arm - Handing Reversible	\$3600

*For Double Doors with single header, double single unit price.



MODULES & ACCESSORIES

POWER SUPPLY ACCESSORIES

DS1+	Door Sequencer	\$175
DS1-X	Door Sequencer	\$200
VD2-873	Replacement Relay Board for Von Duprin PS873 (871-2 board)	\$200
VD2-914	Replacement Relay Board for Von Duprin PS914 (2RS board)	\$200

POWER ACCESSORIES

CAT FT	COMPLETE FIELD TESTER, specify battery (DeWalt, Makita, Milwaukee)	\$226
CAT FT ATTACHMENT	Replacement Battery Attachment, specify battery (DeWalt, Makita, Milwaukee)	\$30
PM300	Power Module for Solenoids powered by DC Power sources	\$210
PM300-D	Power Module for Solenoids powered by DC Power sources w/ built-in .5 second delay	\$210
PM300-AC	Power Module for Solenoids powered by AC Power sources	\$210
PM300-ACD	Power Module for Solenoids powered by AC Power sources w/ built-in .5 second delay	\$210
CRU	Current Reduction Unit for solenoid powered Mortise & Cylindrical locks, Strikes & Exit Trim	\$39
POD Module	Power ON Delay Module - In-Line module allows for .5-5 second delay in activation	\$48
VC3024	Voltage Converter 30VDC to 24VDC	\$48
VC2412	Voltage Converter 24VDC to 12VDC	\$48



SWITCH ACCESSORIES

CAT-AIR-REX	Active Infrared Request to Exit	\$235
IDPS1	Independent DPS switch installs in frame & alum (wood, hollow metal, & FRP)	\$33
IDPS2	Independent High Security DPS switch installs in frame & alum (wood, hollow metal, & FRP)	\$44
IDPSSC-1	Vandal Resistance Independent Concealed Magnetic Contact switch DPS switch installs in frame & alum (wood, hollow metal, & FRP)	\$90
CAT-IVES-DP2	IVES Dust Proof Strike w/ Internal DPS	\$160

ACTUATORS & MORE ACCESSORIES

TA120	Touchless Actuator - Wave to Open Logo - Surface Mount	\$220
TA121	Touchless Actuator - Wave to Lock Logo - Surface Mount	\$220
TA122	Touchless Actuator - Wave to Open + Handicap Logo - Surface Mount	\$220
2WRB	2 Wire Retrofit Board - allows 4 wire touchless actuator to use 2 existing wires	\$215
RB1	Remote Buzzer Single Gang	\$65
RB1-NS	Remote Buzzer Narrow Stile	\$65
DTC MOMA2	Remote 2 Door Desktop Console	\$580
DTC MOMA4	Remote 4 Door Desktop Console	\$800
DTC MOMA8	Remote 8 Door Desktop Console	\$1775



POWER TRANSFER HINGES

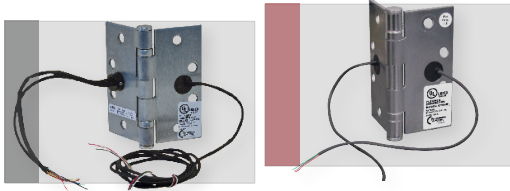

ELEMENTS OF A PART NUMBER



molex



TYPE
ETH - Energy Transfer Hinge
ETM - Energy Transfer Monitor Hinge

WIRES	
M - Monitor Only	2WH* - (2/18ga)
2W - (2/20ga)	4WH* - (2/18ga+2/26ga)
4W - (4/26ga)	6WH* - (2/18ga+4/28ga)
6W - (6/26ga)	8WH* - (2/20ga+6/28ga)
8W - (8/28ga)	10WH* - (2/20ga+8/28ga)
10W - (10/28ga)	12WH* - (2/20ga+10/28ga)
12W - (12/28ga)	

*NOT AVAILABLE ON ALL HINGES SIZES .

SIZE / HANDING	
4.0 x 4.0 (SQ or RC)	5.0 x 5.0
4.5 x 4.0 (SQ or RC)	4.5 x 6.0 (WT)
4.5 x 4.5	5.0 x 6.0 (WT)
5.0 x 4.0	LH - Left Hand
5.0 x 4.5	RH - Right Hand

OPTIONS
QC - Molex Connectors HT - Hospital Tip (SS/Brass Only)
4' Leads - ALWAYS SUPPLIED AT NO CHARGE

FINISH (Steel Base Metal)	
600/P - Prime Coat	641/10A - Antique Bronze Laq.
605-632/3 - Bright Brass	613-640/10B - Anti. Bronze Oil
606-633/4 - Satin Brass	619-646/15 - Satin Nickel
609-638/5 - Satin Brass Antique	625-651/26 - Bright Chrome
611-637/9 - Bright Bronze	626-652/26D - Satin Chrome
612-639/10 - Satin Bronze	693/L1 - Black
FINISH (Brass Base Metal)	
600/P - Prime Coat	613/10B - Antique Bronze Oil
605/3 - Bright Brass	619/15 - Satin Nickel
606/4 - Satin Brass	625/26 - Bright Chrome
609/5 - Satin Brass Antique	626/26D - Satin Chrome
611/9 - Bright Bronze	693/L1 - Black ¹
612/10 - Satin Bronze	
FINISH (Stainless Steel Base Metal)	
629 - Polished Stainless	630 - Brushed Stainless

STYLE	
3SW - 3 Knuckle Standard Weight	CATPIVOT - 3/4" Offset Pivot
3HW - 3 Knuckle Heavy Weight	5SWSC - CAT Swingclear Standard weight (specify straight or bevelled)
5SW - 5 Knuckle Standard Weight	
5HW - 5 Knuckle Heavy Weight	
3/4" - offset pivot (top/intermediate)	PP - Pocket pivot (center hung)
1-1/2" - offset pivot (top/intermediate)	SC - Swing Clear Hinge
TP - Top pivot (center hung)	RB - Raised Barrel

EXTRA HINGES FOR MODIFICATION

Due to the nature of the modification process, please send 1 extra hinge for every 8 to be modified. We will return any hinges not need back with your order.

¹For Example: 1-8 hinges, 1 extra | 9-16 hinges, 2 extra .

EXAMPLES

MODIFICATION ONLY - BUTT HINGE

	TYPE	WIRES	SIZE	BASE	STYLE	HANDING	OPTIONS	COMPLETE PART #
Part #	ETM	4W	4540	Steel	3CB1	-	QC	ETM4WMOD-3CB1 QC
List \$	-	\$212	-	-	-	-	\$46	\$258

COMPLETE ENERGY TRANSFER HINGE

	TYPE	WIRES	SIZE	FINISH	STYLE	HANDING	OPTIONS	COMPLETE PART #
Part #	ETH	8W	4545	626	BB79	-	4' Lead	ETH8W4545-626 BB79
List \$	-	\$156	-	-	-	-	N/C	\$156

COMPLETE ENERGY TRANSFER PIVOT

	TYPE	WIRES	SIZE	FINISH	STYLE	HANDING	OPTIONS	COMPLETE PART #
Part #	ETH	420W	-	626	CATPIVOT	RH	4' Lead	ETH420W-626-CATPIVOT RH
List \$	-	\$322+30	-	-	-	-	N/C	\$352

Command Access is not a licensee or affiliated, associated or connected with Allegion, Assa Abloy, Dorma, Stanley Security, Adams Rite, Arrow, Corbin Russwin, McKinney, Pemko, Rixson, Sargent, Yale, Dor-O-matic, Falcon, Ives, Monarch, Schlage, Von Duprin, Best, Precision, Accurate, AHT, Baldwin, Bommer, Cal Royal, CR Laurence, Design Hardware, Emtek, First Choice, FSB, General Lock, Hager, Jackson, Keedex, Lawrence, LSDA, Marks, Marshal-Best, Molex, Omnia, PBB, PDQ, or any of their subsidiaries or affiliates.

HOW TO ORDER

HOW TO MEASURE A HINGE REFERENCE

EXAMPLE: 4.5 (HEIGHT) x 4.0 (WIDTH)

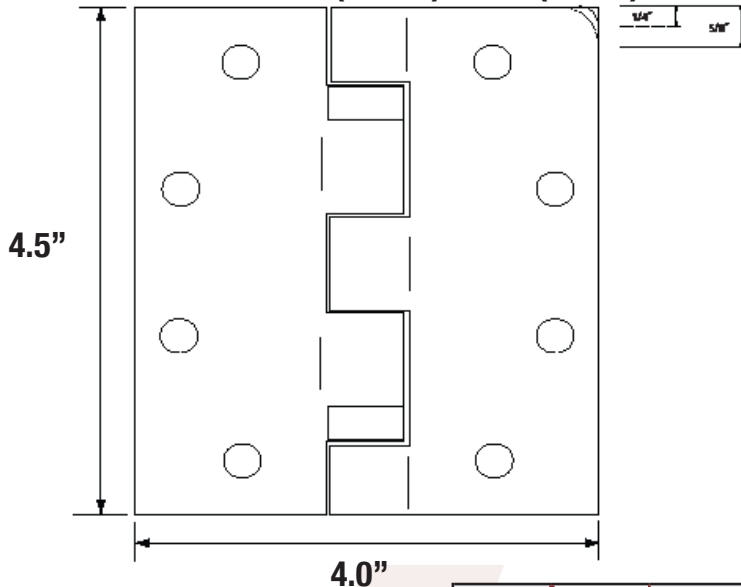

TYPES OF HINGES

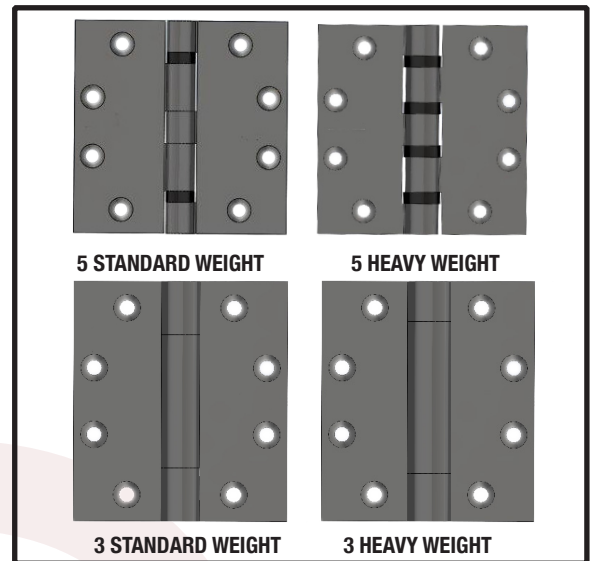

HINGE CROSS REFERENCE SHEET

	COMMAND ACCESS	HAGER	STANLEY	MCKINNEY	PBB	IVES	CAL ROYAL	BOMMER
5 KNUCKLE - SW STEEL BASE	BB79	BB1279	FBB179 CB179	TA2714	BB81	5BB1	BB31	BB5000
5 KNUCKLE - SW BRASS BASE	BB91	BB1191	FB191 CB191	TA2314	BB21	5BB1	SBB31	BB5001
5 KNUCKLE - SW STAINLESS STEEL BASE	BB91	BB1191	FBB191 CB191	TA2314	BB51	5BB1	BB31-630	BB5002
5 KNUCKLE - HW STEEL BASE	BB68	BB1168	FBB168 CB168	T4A3786	4B81	5BB1HW	BB5200	BB5004
5 KNUCKLE - HW BRASS BASE	BB99	BB1199	FB199 CB199	T4A3385	4B81	5BB1HW	N/A	BB5005
5 KNUCKLE - HW STAINLESS STEEL BASE	BB99	BB1199	FBB199 CB199	T4A3385	4B21	5BB1HW	BB5200-630	BB5006
3 KNUCKLE - SW STEEL BASE	CB70	AB700	CB1900R	TA714	CB81	3CB1	BB200	LB8000
3 KNUCKLE - SW BRASS BASE	CB80	AB800	CB1960R	TA314	CB21	3CB1	N/A	LB8001
3 KNUCKLE - SW STAINLESS STEEL BASE	CB80	AB800	CB1960R	TA314	CB51	3CB1	BB2200-630	LB8002
3 KNUCKLE - HW STEEL BASE	CB75	AB750	CB1901R	TA786	4C81	3CB1HW	BB3300	LB8004
3 KNUCKLE - HW BRASS BASE	CB85	AB850	CB1961R	TA386	4C21	3CB1HW	N/A	LB8005
3 KNUCKLE - HW STAINLESS STEEL BASE	CB85	AB850	CB1961R	TA386	4C51	3CB1HW	BB3300-630	LB8006

5 KNUCKLE STANDARD TRANSFER HINGES - ETH

STEEL BASE (BB79)	2W	4W	6W	8W	10W	12W	2WH	4WH	6WH	8WH	10WH	12WH
4.0 x 4.0	\$124	\$124	\$146	\$156	\$187	\$187	-	-	-	-	-	-
4.5 x 4.0	\$124	\$124	\$146	\$156	\$187	\$187	\$172	\$187	\$197	\$206	\$237	\$250
4.5 x 4.5	\$124	\$124	\$146	\$156	\$187	\$187	\$172	\$187	\$197	\$206	\$237	\$250
5.0 x 4.5	\$149	\$149	\$167	\$187	\$210	\$210	\$197	\$212	\$222	\$237	\$260	\$273
5.0 x 5.0	\$171	\$171	\$189	\$210	\$232	\$232	\$219	\$234	\$244	\$260	\$282	\$295
BRASS BASE (BB91)	2W	4W	6W	8W	10W	12W	2WH	4WH	6WH	8WH	10WH	12WH
4.0 x 4.0	\$158	\$158	\$175	\$193	\$210	\$210	-	-	-	-	-	-
4.5 x 4.0	\$158	\$158	\$175	\$193	\$210	\$210	\$206	\$221	\$231	\$243	\$260	\$273
4.5 x 4.5	\$158	\$158	\$175	\$193	\$210	\$210	\$206	\$221	\$231	\$243	\$260	\$273
5.0 x 4.5	\$175	\$175	\$193	\$210	\$230	\$230	\$223	\$238	\$248	\$260	\$280	\$293
5.0 x 5.0	\$189	\$189	\$210	\$230	\$250	\$250	\$237	\$252	\$262	\$280	\$300	\$313
STAINLESS STEEL BASE (BB91)	2W	4W	6W	8W	10W	12W	2WH	4WH	6WH	8WH	10WH	12WH
4.0 x 4.0	\$171	\$171	\$190	\$205	\$247	\$247	-	-	-	-	-	-
4.5 x 4.0	\$171	\$171	\$190	\$205	\$247	\$247	\$219	\$234	\$244	\$255	\$297	\$310
4.5 x 4.5	\$171	\$171	\$190	\$205	\$247	\$247	\$219	\$234	\$244	\$255	\$297	\$310
5.0 x 4.5	\$190	\$190	\$210	\$230	\$263	\$263	\$238	\$253	\$263	\$280	\$313	\$326
5.0 x 5.0	\$210	\$210	\$230	\$247	\$280	\$280	\$258	\$273	\$283	\$297	\$330	\$343

5 KNUCKLE HEAVY TRANSFER HINGES - ETH

STEEL BASE (BB68)	2W	4W	6W	8W	10W	12W	2WH	4WH	6WH	8WH	10WH	12WH
4.5 x 4.0	\$164	\$164	\$181	\$195	\$212	\$212	\$212	\$227	\$237	\$248	\$265	\$278
4.5 x 4.5	\$164	\$164	\$181	\$195	\$212	\$212	\$212	\$227	\$237	\$248	\$265	\$278
5.0 x 4.5	\$184	\$184	\$199	\$212	\$229	\$229	\$232	\$247	\$257	\$265	\$252	\$295
5.0 x 5.0	\$197	\$197	\$215	\$224	\$241	\$241	\$245	\$260	\$270	\$277	\$294	\$307
BRASS BASE (BB99)	2W	4W	6W	8W	10W	12W	2WH	4WH	6WH	8WH	10WH	12WH
4.5 x 4.0	\$184	\$184	\$202	\$220	\$239	\$239	\$232	\$247	\$257	\$273	\$292	\$305
4.5 x 4.5	\$184	\$184	\$202	\$220	\$239	\$239	\$232	\$247	\$257	\$273	\$292	\$305
5.0 x 4.5	\$202	\$202	\$220	\$239	\$257	\$257	\$250	\$265	\$275	\$292	\$310	\$323
5.0 x 5.0	\$215	\$215	\$232	\$250	\$275	\$275	\$263	\$278	\$288	\$303	\$328	\$341
STAINLESS STEEL BASE (BB99)	2W	4W	6W	8W	10W	12W	2WH	4WH	6WH	8WH	10WH	12WH
4.5 x 4.0	\$206	\$206	\$215	\$234	\$262	\$262	\$254	\$269	\$279	\$287	\$315	\$328
4.5 x 4.5	\$206	\$206	\$215	\$234	\$262	\$262	\$254	\$269	\$279	\$287	\$315	\$328
5.0 x 4.5	\$220	\$220	\$239	\$255	\$283	\$283	\$268	\$283	\$293	\$308	\$336	\$349
5.0 x 5.0	\$232	\$232	\$250	\$267	\$296	\$296	\$280	\$295	\$305	\$320	\$349	\$362

5 KNUCKLE ENERGY TRANSFER HINGES- ETH

MODIFICATION ONLY	2W	4W	6W	8W	10W	12W	2WH	4WH	6WH	8WH	10WH	12WH
5 KNUCKLE - SW STEEL OR BRASS	\$110	\$110	\$128	\$144	\$165	\$181	\$161	\$173	\$191	\$207	\$228	\$241
5 KNUCKLE - SW STAINLESS STEEL	\$148	\$148	\$165	\$182	\$199	\$215	\$199	\$211	\$229	\$245	\$262	\$275
5 KNUCKLE - HW STEEL OR BRASS	\$123	\$123	\$139	\$156	\$173	\$189	\$174	\$186	\$204	\$219	\$236	\$249
5 KNUCKLE - HW STAINLESS STEEL	\$162	\$162	\$179	\$197	\$214	\$230	\$213	\$225	\$243	\$260	\$277	\$290

3 KNUCKLE STANDARD TRANSFER HINGES - ETH

STEEL BASE (CB70)	2W	4W	6W	8W	10W	12W	2WH	4WH	6WH	8WH	10WH	12WH
4.5 x 4.0	\$138	\$138	\$155	\$172	\$189	\$189	\$186	\$201	\$211	\$225	\$242	\$255
4.5 x 4.5	\$138	\$138	\$155	\$172	\$189	\$189	\$186	\$201	\$211	\$225	\$242	\$255
5.0 x 4.5	\$158	\$158	\$175	\$193	\$210	\$210	\$206	\$221	\$231	\$246	\$263	\$276
5.0 x 5.0	\$175	\$175	\$193	\$210	\$228	\$228	\$223	\$238	\$248	\$263	\$281	\$294
BRASS BASE (CB80)	2W	4W	6W	8W	10W	12W	2WH	4WH	6WH	8WH	10WH	12WH
4.5 x 4.0	\$167	\$167	\$184	\$202	\$220	\$220	\$215	\$230	\$240	\$255	\$273	\$286
4.5 x 4.5	\$167	\$167	\$184	\$202	\$220	\$220	\$215	\$230	\$240	\$255	\$273	\$286
5.0 x 4.5	\$184	\$184	\$202	\$220	\$239	\$239	\$232	\$247	\$257	\$273	\$292	\$305
5.0 x 5.0	\$197	\$197	\$215	\$232	\$252	\$252	\$245	\$260	\$270	\$285	\$305	\$318
STAINLESS STEEL BASE (CB80)	2W	4W	6W	8W	10W	12W	2WH	4WH	6WH	8WH	10WH	12WH
4.5 x 4.0	\$181	\$181	\$198	\$215	\$232	\$232	\$229	\$244	\$254	\$268	\$285	\$298
4.5 x 4.5	\$181	\$181	\$198	\$215	\$232	\$232	\$229	\$244	\$254	\$268	\$285	\$298
5.0 x 4.5	\$202	\$202	\$220	\$237	\$257	\$257	\$250	\$265	\$275	\$290	\$310	\$323
5.0 x 5.0	\$215	\$215	\$237	\$255	\$272	\$272	\$263	\$278	\$288	\$308	\$325	\$338

3 KNUCKLE HEAVY TRANSFER HINGES - ETH

STEEL BASE (CB75)	2W	4W	6W	8W	10W	12W	2WH	4WH	6WH	8WH	10WH	12WH
4.5 x 4.0	\$164	\$164	\$183	\$202	\$215	\$215	\$212	\$227	\$237	\$255	\$268	\$281
4.5 x 4.5	\$164	\$164	\$183	\$202	\$215	\$215	\$212	\$227	\$237	\$255	\$268	\$281
5.0 x 4.5	\$184	\$184	\$204	\$224	\$237	\$237	\$232	\$247	\$257	\$277	\$290	\$303
5.0 x 5.0	\$206	\$206	\$226	\$246	\$259	\$259	\$254	\$269	\$279	\$299	\$312	\$325
BRASS BASE (CB85)	2W	4W	6W	8W	10W	12W	2WH	4WH	6WH	8WH	10WH	12WH
4.5 x 4.0	\$180	\$180	\$197	\$215	\$232	\$232	\$228	\$243	\$253	\$268	\$285	\$298
4.5 x 4.5	\$180	\$180	\$197	\$215	\$232	\$232	\$228	\$243	\$253	\$268	\$285	\$298
5.0 x 4.5	\$197	\$197	\$215	\$232	\$250	\$250	\$245	\$260	\$270	\$285	\$303	\$316
5.0 x 5.0	\$220	\$220	\$237	\$255	\$272	\$272	\$268	\$283	\$293	\$308	\$325	\$338
STAINLESS STEEL BASE (CB85)	2W	4W	6W	8W	10W	12W	2WH	4WH	6WH	8WH	10WH	12WH
4.5 x 4.0	\$194	\$194	\$212	\$234	\$257	\$257	\$242	\$257	\$267	\$287	\$310	\$323
4.5 x 4.5	\$194	\$194	\$212	\$234	\$257	\$257	\$242	\$257	\$267	\$287	\$310	\$323
5.0 x 4.5	\$215	\$215	\$234	\$257	\$275	\$275	\$263	\$278	\$288	\$310	\$328	\$341
5.0 x 5.0	\$237	\$237	\$257	\$279	\$296	\$296	\$285	\$300	\$310	\$332	\$349	\$362

3 KNUCKLE ENERGY TRANSFER HINGES- ETH

MODIFICATION ONLY	2W	4W	6W	8W	10W	12W	2WH	4WH	6WH	8WH	10WH	12WH
3 KNUCKLE - SW STEEL OR BRASS	\$114	\$114	\$131	\$148	\$165	\$181	\$165	\$177	\$195	\$211	\$228	\$241
3 KNUCKLE - SW STAINLESS STEEL	\$156	\$156	\$173	\$189	\$207	\$223	\$207	\$219	\$237	\$252	\$270	\$283
3 KNUCKLE - HW STEEL OR BRASS	\$139	\$139	\$156	\$173	\$190	\$206	\$190	\$202	\$220	\$236	\$253	\$266
3 KNUCKLE - HW STAINLESS STEEL	\$169	\$169	\$187	\$204	\$222	\$238	\$220	\$232	\$250	\$267	\$285	\$298

5 KNUCKLE STANDARD TRANSFER HINGES - ETM

STEEL BASE (BB79)	M	2W	4W	6W	8W	10W	2WH	4WH	6WH	8WH
4.5 x 4.0	\$135	\$224	\$224	\$244	\$262	\$272	\$272	\$299	\$314	\$337
4.5 x 4.5	\$135	\$224	\$224	\$244	\$262	\$272	\$272	\$299	\$314	\$337
5.0 x 4.5	\$152	\$241	\$241	\$262	\$280	\$291	\$289	\$316	\$331	\$355
5.0 x 5.0	\$174	\$264	\$264	\$285	\$302	\$313	\$312	\$339	\$354	\$377
BRASS BASE (BB91)	M	2W	4W	6W	8W	10W	2WH	4WH	6WH	8WH
4.5 x 4.0	\$161	\$253	\$253	\$268	\$287	\$304	\$311	\$328	\$343	\$362
4.5 x 4.5	\$161	\$253	\$253	\$268	\$287	\$304	\$311	\$328	\$343	\$362
5.0 x 4.5	\$179	\$270	\$270	\$287	\$304	\$322	\$328	\$345	\$360	\$379
5.0 x 5.0	\$201	\$292	\$292	\$304	\$327	\$345	\$350	\$367	\$382	\$402
STAINLESS STEEL BASE (BB91)	M	2W	4W	6W	8W	10W	2WH	4WH	6WH	8WH
4.5 x 4.0	\$179	\$268	\$268	\$287	\$304	\$322	\$326	\$343	\$358	\$379
4.5 x 4.5	\$179	\$268	\$268	\$287	\$304	\$322	\$326	\$343	\$358	\$379
5.0 x 4.5	\$197	\$287	\$287	\$304	\$322	\$341	\$345	\$362	\$377	\$397
5.0 x 5.0	\$221	\$309	\$309	\$326	\$345	\$362	\$367	\$384	\$399	\$420

5 KNUCKLE HEAVY TRANSFER HINGES - ETM

STEEL BASE (BB68)	M	2W	4W	6W	8W	10W	2WH	4WH	6WH	8WH
4.5 x 4.0	\$176	\$269	\$269	\$288	\$305	\$315	\$327	\$344	\$359	\$380
4.5 x 4.5	\$176	\$269	\$269	\$288	\$305	\$315	\$327	\$344	\$359	\$380
5.0 x 4.5	\$195	\$288	\$288	\$305	\$325	\$335	\$346	\$363	\$378	\$400
5.0 x 5.0	\$217	\$311	\$311	\$330	\$335	\$346	\$369	\$386	\$401	\$410
BRASS BASE (BB99)	M	2W	4W	6W	8W	10W	2WH	4WH	6WH	8WH
4.5 x 4.0	\$191	\$276	\$276	\$295	\$313	\$331	\$334	\$351	\$366	\$388
4.5 x 4.5	\$191	\$276	\$276	\$295	\$313	\$331	\$334	\$351	\$366	\$388
5.0 x 4.5	\$208	\$295	\$295	\$313	\$331	\$349	\$353	\$370	\$385	\$406
5.0 x 5.0	\$230	\$318	\$318	\$335	\$353	\$371	\$376	\$393	\$428	\$428
STAINLESS STEEL BASE (BB99)	M	2W	4W	6W	8W	10W	2WH	4WH	6WH	8WH
4.5 x 4.0	\$208	\$295	\$295	\$313	\$331	\$349	\$353	\$370	\$385	\$406
4.5 x 4.5	\$208	\$295	\$295	\$313	\$331	\$349	\$353	\$370	\$385	\$406
5.0 x 4.5	\$237	\$327	\$327	\$345	\$362	\$381	\$385	\$402	\$417	\$437
5.0 x 5.0	\$253	\$341	\$341	\$358	\$404	\$393	\$399	\$416	\$431	\$479

5 KNUCKLE ENERGY TRANSFER HINGES- ETM

MODIFICATION ONLY	M	2W	4W	6W	8W	10W	2WH	4WH	6WH	8WH
5 KNUCKLE - SW STEEL OR BRASS	\$116	\$206	\$206	\$222	\$242	\$259	\$257	\$273	\$293	\$310
5 KNUCKLE - SW STAINLESS STEEL	\$151	\$241	\$241	\$259	\$274	\$291	\$292	\$310	\$328	\$342
5 KNUCKLE - HW STEEL OR BRASS	\$125	\$212	\$212	\$232	\$250	\$265	\$263	\$283	\$301	\$316
5 KNUCKLE - HW STAINLESS STEEL	\$160	\$250	\$265	\$265	\$283	\$300	\$301	\$316	\$334	\$351

3 KNUCKLE STANDARD TRANSFER HINGES - ETM

STEEL BASE (CB70)	M	2W	4W	6W	8W	10W	2WH	4WH	6WH	8WH
4.5 x 4.0	\$143	\$235	\$235	\$253	\$268	\$287	\$293	\$310	-	-
4.5 x 4.5	\$143	\$235	\$235	\$253	\$268	\$287	\$293	\$310	-	-
5.0 x 4.5	\$161	\$253	\$253	\$270	\$287	\$304	\$311	\$328	-	-
5.0 x 5.0	\$184	\$275	\$275	\$293	\$309	\$327	\$333	\$350	-	-
BRASS BASE (CB80)	M	2W	4W	6W	8W	10W	2WH	4WH	6WH	8WH
4.5 x 4.0	\$161	\$253	\$253	\$268	\$287	\$304	\$311	\$328	\$343	\$362
4.5 x 4.5	\$161	\$253	\$253	\$268	\$287	\$304	\$311	\$328	\$343	\$362
5.0 x 4.5	\$179	\$270	\$270	\$287	\$304	\$322	\$328	\$345	\$360	\$379
5.0 x 5.0	\$201	\$293	\$293	\$309	\$327	\$345	\$351	\$368	\$383	\$402
STAINLESS STEEL BASE (CB80)	M	2W	4W	6W	8W	10W	2WH	4WH	6WH	8WH
4.5 x 4.0	\$184	\$272	\$272	\$291	\$309	\$327	\$330	\$347	\$362	\$384
4.5 x 4.5	\$184	\$272	\$272	\$291	\$309	\$327	\$330	\$347	\$362	\$384
5.0 x 4.5	\$201	\$291	\$291	\$309	\$327	\$345	\$349	\$366	\$381	\$402
5.0 x 5.0	\$224	\$313	\$313	\$334	\$349	\$367	\$371	\$388	\$403	\$424

3 KNUCKLE HEAVY TRANSFER HINGES - ETM

STEEL BASE (CB75)	M	2W	4W	6W	8W	10W	2WH	4WH	6WH	8WH
4.5 x 4.0	\$170	\$262	\$262	\$278	\$295	\$313	\$320	\$333	-	-
4.5 x 4.5	\$170	\$262	\$262	\$278	\$295	\$313	\$320	\$333	-	-
5.0 x 4.5	\$188	\$281	\$281	\$295	\$313	\$331	\$339	\$350	-	-
5.0 x 5.0	\$210	\$302	\$302	\$318	\$335	\$353	\$360	\$373	-	-
BRASS BASE (CB85)	M	2W	4W	6W	8W	10W	2WH	4WH	6WH	8WH
4.5 x 4.0	\$191	\$278	\$278	\$295	\$313	\$331	\$336	\$353	\$368	\$388
4.5 x 4.5	\$191	\$278	\$278	\$295	\$313	\$331	\$336	\$353	\$368	\$388
5.0 x 4.5	\$208	\$295	\$295	\$313	\$331	\$349	\$353	\$370	\$385	\$406
5.0 x 5.0	\$231	\$318	\$318	\$335	\$353	\$371	\$376	\$393	\$408	\$428
STAINLESS STEEL BASE (CB85)	M	2W	4W	6W	8W	10W	2WH	4WH	6WH	8WH
4.5 x 4.0	\$214	\$304	\$304	\$322	\$347	\$365	\$362	\$379	\$394	\$422
4.5 x 4.5	\$214	\$304	\$304	\$322	\$347	\$365	\$362	\$379	\$394	\$422
5.0 x 4.5	\$233	\$322	\$322	\$341	\$365	\$383	\$380	\$397	\$412	\$440
5.0 x 5.0	\$255	\$345	\$345	\$362	\$387	\$405	\$403	\$420	\$435	\$462

3 KNUCKLE ENERGY TRANSFER HINGES- ETM

MODIFICATION ONLY	M	2W	4W	6W	8W	10W	2WH	4WH	6WH	8WH
3 KNUCKLE - SW STEEL OR BRASS	\$125	\$212	\$212	\$230	\$248	\$265	\$263	\$281	\$299	\$316
3 KNUCKLE - SW STAINLESS STEEL	\$177	\$265	\$265	\$283	\$300	\$318	\$316	\$334	\$351	\$369
3 KNUCKLE - HW STEEL OR BRASS	\$142	\$232	\$232	\$250	\$267	\$285	\$283	\$301	\$318	\$336
3 KNUCKLE - HW STAINLESS STEEL	\$197	\$285	\$285	\$302	\$320	\$338	\$336	\$353	\$371	\$389

COMMAND ACCESS ENERGY TRANSFER SWINGCLEAR

WIRE MORTISE/CYLINDRICAL LOCK, & EXIT TRIM					WIRE HEAVY LATCH RETRACTION			
ETH2W (2/20GA)	ETH4W (4/26GA)	ETH6W (6/26GA)	ETH8W (8/28GA)	ETH10W (10/28GA)	ETH2WH (2/18GA)	ETH4WH (2/18GA + 2/26GA)	ETH6WH (2/18GA + 4/28GA)	ETH8WH (2/20GA + 6/28GA)

Specify Bevelled or Square. 626 Finish. Consult factory for other finishes.

5SW STEEL BASED SC	\$367	\$367	\$386	\$403	\$420	\$415	\$434	\$451	\$468
5HW STEEL BASED SC	\$411	\$411	\$431	\$446	\$465	\$459	\$479	\$494	\$513

ENERGY TRANSFER SPECIALTY- MOD

HINGE TYPE	2W	4W	6W	8W	10W	2WH	4WH	6WH	8WH
SWINGCLEAR - SW STEEL HINGE	\$268	\$268	\$286	\$304	\$322	\$317	\$328	\$346	\$364
SWINGCLEAR - HW STEEL HINGE	\$294	\$294	\$313	\$330	\$348	\$343	\$354	\$373	\$390
SWINGCLEAR - SW SS HINGE	\$304	\$304	\$322	\$340	\$358	\$353	\$364	\$382	\$400
SWINGCLEAR - HW SS HINGE	\$330	\$330	\$348	\$367	\$384	\$379	\$390	\$408	\$427
RAISED BARREL - SW STEEL HINGE	\$268	\$268	\$286	\$304	\$322	\$317	\$328	\$346	\$364
RAISED BARREL - HW STEEL HINGE	\$294	\$294	\$313	\$348	\$360	\$343	\$354	\$373	\$390
RAISED BARREL - SW SS HINGE	\$304	\$304	\$322	\$340	\$358	\$353	\$364	\$382	\$400
RAISED BARREL - HW SS HINGE	\$330	\$330	\$348	\$367	\$384	\$379	\$390	\$408	\$427
HALF OR FULL SURFACE - SW STEEL	\$280	\$280	\$296	\$315	\$332	\$329	\$340	\$356	\$375
HALF OR FULL SURFACE - HW STEEL	\$296	\$296	\$315	\$332	\$351	\$345	\$356	\$375	\$392
HALF OR FULL SURFACE - SW SS	\$313	\$313	\$330	\$349	\$367	\$362	\$373	\$390	\$409
HALF OR FULL SURFACE - HW SS	\$334	\$334	\$353	\$371	\$388	\$383	\$394	\$413	\$431

NOTE: Wire access hole location on all hinges, regardless of hinge manufacturer, are located per Command Access Templates unless otherwise requested. Our standard templates are available on our website at www.commandaccess.com.

COMMAND ACCESS ENERGY TRANSFER PIVOTS

Specify Handing, Finishes available in 613, 625, 626.

HINGE TYPE	2W	4W	6W	8W	10W	12W	2WH	4WH	6WH	8WH	10WH	12WH
INTERMEDIATE PIVOT - CAT PIVOT	\$322	\$322	\$340	\$358	\$376	\$386	\$370	\$388	\$406	\$424	\$434	\$449

ENERGY TRANSFER PIVOTS - MOD

HINGE TYPE	2W	4W	6W	8W	10W	12W	2WH	4WH	6WH	8WH	10WH	12WH
3/4" OFFSET BRASS OR ALUMINUM	\$304	\$304	\$322	\$340	\$358	\$369	\$353	\$364	\$382	\$400	\$418	\$429
3/4" OFFSET STAINLESS STEEL	\$330	\$330	\$348	\$367	\$384	\$395	\$379	\$390	\$408	\$427	\$444	\$455
1-1/2" OFFSET BRASS OR ALUMINUM	\$313	\$313	\$330	\$348	\$367	\$377	\$362	\$373	\$390	\$408	\$427	\$438
1-1/2" OFFSET STAINLESS STEEL	\$340	\$340	\$358	\$376	\$392	\$404	\$389	\$400	\$418	\$436	\$452	\$463
TOP, POCKET, OR CENTER HUNG PIVOT	\$178	\$178	\$196	\$214	\$232	\$242	\$227	\$238	\$256	\$274	\$292	\$302

CONCEALED EPT

CAT EPT ALUM	Concealed Power Transfer ALUM specify (2 Wire or 10 Wire), same prep as Von Duprin EPT	\$455
CAT EPT DURO	Concealed Power Transfer DURO specify (2 Wire or 10 Wire), same prep as Von Duprin EPT	\$455

CONCEALED DOOR LOOPS

CDL-AL	Aluminum Finish, 6" total length.	\$50
CDL-BLK	Black Finish, 6" total length.	\$50
CDL-AL-FX	Aluminum Finish, 6" total length. Includes 1 side fixed for complete concealment in opposite side.	\$54
CDL-BLK-FX	Black Finish, 6" total length. Includes 1 side fixed for complete concealment in opposite side.	\$54

FOR 3/4" OFFSET PIVOT APPLICATIONS

CDL-AL-EXT	Aluminum Finish, 12" total length. Includes 1 side fixed for complete concealment in opposite side & extended length for wire guidance	\$64
CDL-BLK-EXT	Black Finish, 12" total length. Includes 1 side fixed for complete concealment in opposite side & extended length for wire guidance	\$64
CDL-AL-EXT2	Aluminum Finish, 18" total length. Includes 1 side fixed for complete concealment in opposite side & extended length for wire guidance	\$82
CDL-BLK-EXT2	Black Finish, 18" total length. Includes 1 side fixed for complete concealment in opposite side & extended length for wire guidance	\$82

DOOR LOOPS

DL-20A	20" Door Loop, Aluminum Finish (Can be cut in the field to length)	\$46
DL-20D	20" Door Loop, Aluminum Finish (Can be cut in the field to length)	\$46
NDL-18A	Narrow 18" Door Loop, Aluminum Finish (Can be cut in the field to length)	\$40
NDL-18D	Narrow 18" Door Loop, Aluminum Finish (Can be cut in the field to length)	\$40

ADDITIONAL OPTIONS FOR POWER TRANSFER

DOOR 4' LEAD	Standard 4' Lead on Door Side - Included Standard with every hinge	n/c
FRAME 4' LEAD	Add 4' Lead on Frame Side	CALL
WT	Additional charge to supply a wide throw hinge	\$44
QC/CON	8-pin or 12-pin Molex Connectors added to locking device retrofit ElectroLynx or Allegion Connect	\$28
QC/CON w/ lead	8-pin or 12-pin Molex Connectors w/3-5' lead added to locking device retrofit ElectroLynx or Allegion Connect	\$48
QC/CON w/ Lead	8/12-pin Molex Connectors w/ 10-20' lead added to connect a power supply directly to a QC/CON prepped power transfer hinge	\$105
Door Cord QC/CON	3-5' Door Cord to connect a QC prepped locking device to the power transfer hinge	\$85
HT	Add Hospital Tip to Hinge (SS/Brass Only)	\$88
CAT HINGE REWIRE	Rewire Command Access Hinge	\$88
OTHER HINGE REWIRE	Rewire another manufacturers hinge	\$106



ALLEGION CONNECT® IS A REGISTERED TRADEMARK OF ALLEGION & ELECTROLYNX® IS A REGISTERED TRADEMARK OF ASSA ABLÖY
 MICRO-FIT 3.0™ INTERCONNECT SYSTEM AVAILABLE TO RETROFIT COMMON QUICK CONNECTION SYSTEMS SUCH AS ELECTROLYNX® OR ALLEGION CONNECT®.

INSTALLATION TOOLS

CAT-HIIT-21	MORTISE LOCK CYLINDER GUIDE	CALL
CAT-HIIT-22	MORTISE LOCK DOUBLE CYLINDER GUIDE	CALL
CAT-HIIT-50	CYLINDRICAL LOCK BORE HOLES	CALL
CAT-HIIT-111	GRADE 1 CYLINDRICAL LOCK FACE HOLES	CALL
CAT-HIT-60	WIRE RACEWAY DRILL GUIDE FOR ELECTRIFIED LOCKS	CALL
CAT-HIIT-66- CLAMP	CLAMP SYSTEM FOR ALL HIT-66 GUIDES	CALL
CAT-HIIT-66-110	CYLINDRICAL LOCKS	CALL
CAT-HIIT-66-282	SCHLAGE L SERIES MORTISE LOCK	CALL
CAT-HIT-32VD9W	VON DUPRIN 98/99 WOOD RIM & SVR	CALL
CAT-DT-200	CYLINDRICAL LOCK BORE HOLES	CALL
CAT-DT-100	CYLINDRICAL LOCK BORE HOLES	CALL
DOOR DOLLY 1	MINI DOOR DOLLY	CALL
DOOR DOLLY 2	DOOR DOLLY	CALL

Command Access is not a licensee or affiliated, associated or connected with Allegion, Assa Abloy, Dorma, Stanley Security, Adams Rite, Arrow, Corbin Russwin, Mckinney, Pemko, Rixson, Sargent, Yale, Dor-O-matic, Falcon, Ives, Monarch, Schlage, Von Duprin, Best, Precision, Accurate, AHT, Baldwin, Bommer, Cal Royal, CR Laurence, Design Hardware, Emtek, First Choice, FSB, General Lock, Hager, Jackson, Keedex, Lawrence, LSDA, Marks, Marshal-Best, Molex, Omnia, PBB, PDQ, or any of their subsidiaries or affiliates.

ALWAYS HERE TO HELP!



22901 LA PALMA AVE YORBA LINDA CA 92887

ELECTRIFIED LOCKING HARDWARE

commandaccess.com

888-622-2377



www.commandaccess.com
orders@commandaccess.com
Live Chat Available
Customer Support 1-888-622-2377

WWW.COMMANDACCESS.COM