

Access 800™

Locks

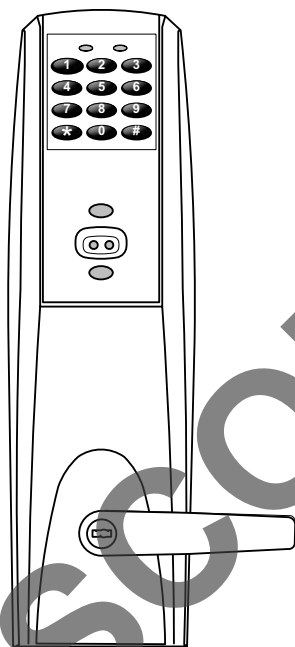

CYLINDRICAL

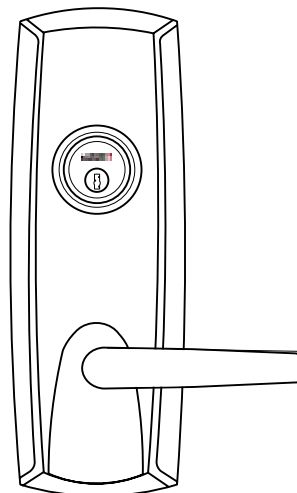
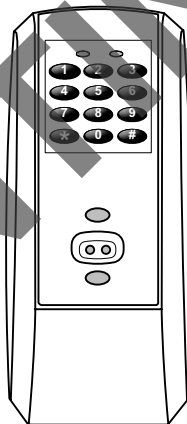

EXIT

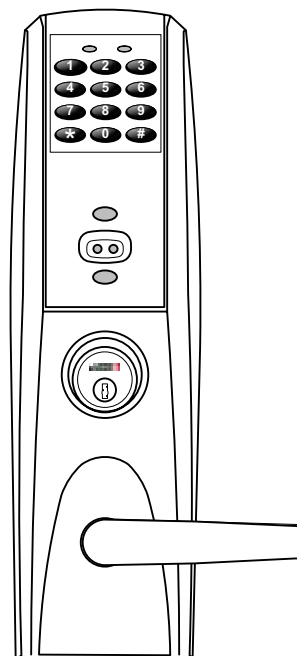

MORTISE

(For products before 2007)

For installation assistance contact Corbin Russwin
1-800-543-3658 • techsupport.corbinrusswin@assaabloy.com

Copyright © 2018-2019 Corbin Russwin, Inc., an ASSA ABLOY Group company. All rights reserved. Reproduction in whole or in part without the express written permission of Corbin Russwin, Inc. is prohibited.

(617417440) FM359 7/19

ASSA ABLOY, the global leader
in door opening solutions

TOC	Table of Contents
1	Overview 2
2	General Programming 3
3	Individual Door Log Sheet for Keypad Programming 3
4	M800 Programming 4
5	M801, M803, M804, M806 Programming 8
6	Chain Programming 14
7	M802 and M805 Programming 15

1 Overview

The Keypad Lock can support 100 (M800) / 2000 (M801 – M806) users. Each user is assigned a User Number in addition to the code used for entry.

Example:

User Type	User Location
Master	01
Supervisor	03 (M800), 02 (M801-M806)
Emergency	02 (M800), 03-2000 (M801-M806)
Standard	04-100 (M800), 03-2000 (M801-M806)

- Accessware applications software must be used for programming with M802 & M805 controller.
- The Master Code is always User Location “01”. The Master Code assigns the Emergency and Supervisory Codes. It is also used for programming. Users are deleted through the Master Programming Code only.
- The Supervisory Code is User Location “03” for M800 and “02” for M801-M806 Technology. The Supervisory Code allows temporary lock out of selected users, changes duration of unlock time, requests infrared interrogation output, and may add additional User Codes.
- The Emergency Code is User Location “02” for M800 and can be assigned to locations “03-2000” for M801-M806 Technology. The Emergency Code cannot be locked out or

disabled. Presentation of a valid credential by this user type will override any locked condition and will unlock the door, including User Lockout and Panic Lockdown states. Presentation of this user type also allows entry on a Access 800™ mortise controller if the deadbolt is thrown. This user type will unlock the door for the time specified in the Door Settings screen under “Lock Timer - Extended Users”.

- The User Codes are entered at user location “04” or higher for M800 and “03” or higher for M801-M806. User locations do not have to be used or entered sequentially.
- The “Lock Out” user is location dependent and will lock out all users beyond this location. To ensure that all users are locked out of the keypad, program this user at location “04” for M800 and “03 for M801-M806.
- The “Passage” user has precedence over all users except the “Panic” user. The lock must be toggled back into a locked state for other users to function.
- Remote Unlocking used for remote unlocking of Access 800 lock. For the Mortise Lock, when the deadbolt is thrown and the remote unlocking feature is used, both the latchbolt and deadbolt can be retracted by turning the lever handle.

2

General Programming

To Begin Programming:

The Lock Controller is preset at the factory with Master Code “1234”. **It is strongly recommended that the Master Code be changed as the first programming step.** Entering 1234 * will unlock the lock allowing the lever handle to retract the latchbolt.

Initial Set-Up Procedures:

- The following are typical procedures to be used when setting up your Access 800 lock.
- If a mistake is made during any of procedures, depress the “*” key several times until the yellow LED goes out.
- If no keystroke is made in a 30 second time frame, the programming up to that point will default and you will have to start over.

Determine which programming steps to use for your lock:

- If your label has an M800, then use the programming in Section 4. (Figure 1)
- If your label has an M801, M803, M804, or M806, reference programming in Section 5. (Figure 2)
- If your label has a M802 or M805, Accessware™ application Software must be used for programming. See Section 7. (Figure 2)

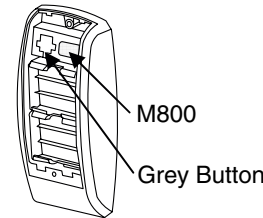

Figure 1

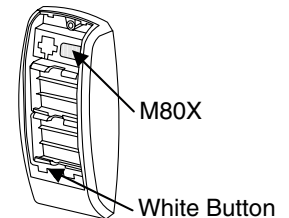

Figure 2

3

Individual Door Log Sheet for Keypad Programming

Lock Model: _____

Door Name: _____

Location: _____

Main Codes - User Programmed “Door” Log			
Function	User Location	Default Code	User Programmed Code
Master Code	01	1234&	
Supervisor Code	02		

***Note: If memory is cleared, you must reprogram Emergency code. The Master code resets back to 1234*.**

User Programmed “Door” Log				
User Name	User Type	User Location	User Code	Card/Fob#, Notes

To Change the Master Code

99# 1234*	Yellow LED blinks
50# 01#	Yellow LED blinks
New Master Code*	Yellow LED blinks quickly
New Master Code*	Yellow LED blinks slowly
*	Yellow LED goes out

This example uses the Factory Default **1234***, yours may differ.

It is strongly recommended not to use the factory default Master code.

Enter the Emergency Code

99# Master Code*	Yellow LED blinks
50# 02#	Yellow LED blinks
Emergency (1-6 digits)*	Yellow LED blinks quickly
Emergency (1-6 digits)*	Yellow LED blinks slowly
*	Yellow LED goes out

Emergency Code defaults to a 10 second unlock time.

Enter the Supervisor Code

99# Master Code*	Yellow LED blinks
50# 1# 03#	Yellow LED blinks
Supervisory (1-6 digits)*	Yellow LED blinks quickly
Supervisory (1-6 digits)*	Yellow LED blinks slowly
*	Yellow LED goes out

Enter A User Code

99# Master Code or Supervisor Code*	Yellow LED blinks
50# 1# (User Location 04-100)#	Yellow LED blinks
User Code (1-6 digits)*	Yellow LED blinks quickly
User Code (1-6 digits)*	Yellow LED blinks slowly
*	Yellow LED goes out

Enter A Passage (Maintained) Code

99# Master Code or Supervisor Code *	Yellow LED blinks
50# 0# (User Location 04-100)#	Yellow LED blinks
User Code (1-6 digits)*	Yellow LED blinks quickly
User Code (1-6 digits)*	Yellow LED blinks slowly
*	Yellow LED goes out

4

M800 Programming

Enter A One Time User Code

99# Master Code or Supervisor Code*	Yellow LED blinks
50# 5# (User Location 04-100)#	Yellow LED blinks
User Code (1-6 digits)*	Yellow LED blinks Quickly
User Code (1-6 digits)*	Yellow LED blinks slowly
*	Yellow LED goes out

To Enable/Disable A User

99# Master Code or Supervisor Code*	Yellow LED blinks
56# 0# (Enable) (User Location 04-100)#	
or 1# (Disable) (User Location 04-100)#	Yellow LED blinks
*	Yellow LED blinks quickly
*	Yellow LED blinks slowly
*	Yellow LED goes out

To Delete A User

99# Master Code	Yellow LED blinks
50# 0# (User Location 04-100)#	Yellow LED blinks
*	Yellow LED blinks quickly
*	Yellow LED blinks slowly
*	Yellow LED goes out

To Set Unlock Time

99# Master Code or Supervisor Code*	Yellow LED blinks
11# (1-99 sec)# 0#	Yellow LED blinks
*	Yellow LED blinks quickly
*	Yellow LED blinks slowly
*	Yellow LED goes out

The Unlock Time is adjustable for Momentary Operation. A 5 second unlock time is recommended to extend battery life. Once the unlock time is entered, it is the same for ALL users except Emergency "02".

To Deactivate / Reactivate "Beep" With Key Stroke

99# Master Code or Supervisor Code*	Yellow LED blinks
30# 0# 0# (Off) or 1# (On)	Yellow LED blinks
*	Yellow LED blinks quickly
*	Yellow LED blinks slowly
*	Yellow LED goes out

4

M800 Programming

To Program Door Name into Keypad

99# Master Code*	Yellow LED blinks
43# Door Name (up to 5 digits)#	Yellow LED blinks
0#	Yellow LED blinks quickly
*	Yellow LED blinks slowly
*	Yellow LED goes out

To Interrogate Transaction Log

To output the last 1000 transactions:

99# Supervisor or Master Code*	Yellow LED blinks
70# 0# 0#	Yellow LED blinks
*	Yellow LED blinks quickly
*	Yellow LED goes out

When printing finishes, the green LED will turn off and the yellow LED will blink slowly.

*	Yellow LED goes out
---	---------------------

Sequence Number

Four digit – Rolling last 1000 transactions, 9999 is highest number

Latest transaction – Highest #, First to print

Oldest transaction – Lowest #, Last to print

Hold an infrared printer up to the infrared LED. (Figure 3) An HP82240B Infrared Printer can be used to download information from the keypad to a printout.

Note: The highest Seq. # is the programming request to output the entries. The balance of Sequence numbers are the actual entries. (Figure 4)

Door Name	Door Seq	Name User	5666 Trans
	0005	001	—
	0004	003	—
	0003	003	—
	0002	020	—
	0001	003	—

Transaction Number User Number Transaction Type

Varies

Figure 4

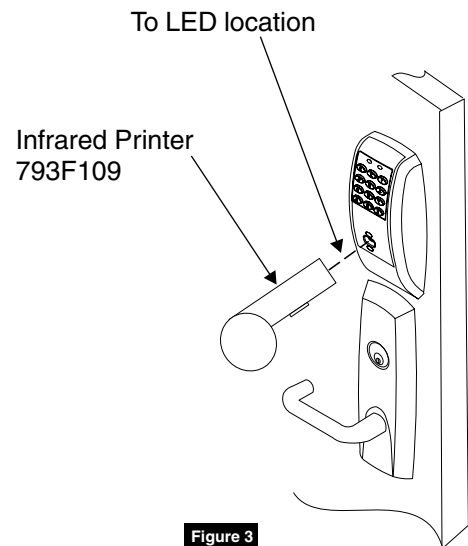

Figure 3

4

M800 Programming

User Location

Three digits - 001 through 100
(User numbers assigned at time of programming)

Transaction Descriptions

Will vary

Optional Equipment

Printer Paper (6 Rolls 794F189) used for infrared printers.
Infrared Printer 793F109 used to download the user and transaction type.

To Reset / Clear Transaction Log

99# Master Code*	Yellow LED blinks
76# 00000# 00000#	Yellow LED blinks
*	Yellow LED blinks quickly
*	Yellow LED blinks slowly
*	Yellow LED goes out

To Clear the Entire Memory and restore Factory default settings

99# Master Code*	Yellow LED blinks
46# 00000# 00000#	Yellow LED blinks
*	Yellow LED blinks quickly
*	Yellow LED blinks rapidly, slowly when complete
*	Yellow LED goes out

This deletes ALL Codes, including Master, Emergency and Supervisor. The Master Code is set back to 1234*. Door Number to 0001 and Unlock Time to 5 seconds. If the Master Code is not known, Factory Assistance will be required to clear the memory.
Call 1-800-810-WIRE (9473)

Status Indicators

- No Green LED after code is entered once and 3 rapid beeps – Invalid Code (Three attempts will lock out for 10 seconds with Yellow LED)
- 4 Long beeps after User code is entered - Low Battery.
- 4 Long beeps after User code is entered, 4 more long beeps - Voltage (batteries) too low to operate. Enter Master Code or Emergency Code to gain entry.
- 1 beep after User Code entered – Disabled User
- 4 beeps after User Code entered – Deadbolt Thrown (Mortise Lock Only)
- 3 beeps after User Code entered – User Lockout

5

M801, M803, M804, M806 Programming

To Change the Master Code

99# 1234*	Yellow LED blinks
50# 1# 01#	Yellow LED blinks
New Master Code*	Yellow LED blinks quickly
New Master Code*	Yellow LED blinks slowly
*	Yellow LED goes out

This example uses the Factory Default **1234***, yours may differ.

It is strongly recommended not to use the factory default Master code.

Enter the Supervisor Code

99# Master Code*	Yellow LED blinks
50# 1# 02#	Yellow LED blinks
Supervisory (1-6 digits)*	Yellow LED blinks quickly
Supervisory (1-6 digits)*	Yellow LED blinks slowly
*	Yellow LED goes out

Enter A User Code

99# Master Code or Supervisor Code*	Yellow LED blinks
50# 1# (User Location 03-2000)#	Yellow LED blinks
User Code (1-6 digits)*	Yellow LED blinks quickly
User Code (1-6 digits)*	Yellow LED blinks slowly
*	Yellow LED goes out

Enter A Panic User Code

99# Master Code or Supervisor Code *	Yellow LED blinks
50# 9# (User Location 03-2000)#	Yellow LED blinks
User Code (1-6 digits)*	Yellow LED blinks quickly
User Code (1-6 digits)*	Yellow LED blinks slowly
*	Yellow LED goes out

Enter A Passage (Maintained) Code

99# Master Code or Supervisor Code*	Yellow LED blinks
50# 0# (User Location 03-2000)#	Yellow LED blinks
User Code (1-6 digits)*	Yellow LED blinks quickly
User Code (1-6 digits)*	Yellow LED blinks slowly
*	Yellow LED goes out

Note: The “Passage” user has precedence over all users except the “Panic” user. The lock must toggled back into a locked state for other users to function.

5

M801, M803, M804, M806 Programming

To Enter the Emergency Code

99# Master Code*	Yellow LED blinks
50# 7# (User Location 03-2000)#	Yellow LED blinks
User Code (1-6 digits)*	Yellow LED blinks quickly
User Code (1-6 digits)*	Yellow LED blinks slowly
*	Yellow LED goes out

Enter a Lock Out User Code

99# Master Code or Supervisor Code*	Yellow LED blinks
50# 3# (User Location 03-2000)#	Yellow LED blinks
User Code*	Yellow LED blinks quickly
User Code*	Yellow LED blinks slowly
*	Yellow LED goes out

Note: The “lock out” user is location dependent and will lock out all users beyond this location. To ensure that all users are locked out of the keypad, program this user at User Location “04”.

Enter A One Time User Code

99# Master Code or Supervisor Code*	Yellow LED blinks
50# 5# (User Location 03-2000)#	Yellow LED blinks
(1-6 Digits)*	Yellow LED blinks quickly
(1-6 Digits)*	Yellow LED blinks slowly
*	Yellow LED goes out

Enter An Extended Unlock User Code

99# Master Code*	Yellow LED blinks
50# 4# (User Location 03-2000)#	Yellow LED blinks
User Code (1-6 digits)*	Yellow LED blinks quickly
User Code (1-6 digits)*	Yellow LED blinks slowly
*	Yellow LED goes out

5

M801, M803, M804, M806 Programming

To Activate The RF FOB Function

Note: Press and hold for 3 seconds the button on the RF FOB. If the controller beeps and the LEDs flash, the RF FOB function is enabled and this procedure does not have to be completed. With the RF FOB function enabled the battery life of the unit will be reduced.

Press the white reset button located in the battery compartment and any front keypad key at the same time and hold for 1 second, then release buttons.

Enter code 1030#

1#

1# (to Enable) or 0# (to Disable)

*

*

*

Yellow LED blinks

Yellow LED blinks

Yellow LED blinks

Yellow LED blinks

Yellow LED blinks quickly

Yellow LED blinks slowly

Yellow LED goes out

Enter a Card, Tag, Fob and RF FOB User

99# Master Code or Supervisor Code*

50# (See Table Below)# (User Location 03-2000)#

*

*

Present Card, Tag, FOB or RF FOB

*

*

Yellow LED blinks

Yellow LED blinks

Yellow LED blinks quickly

Yellow LED blinks slowly

BEEP / Yellow LED blinks

Yellow LED blinks slowly

Yellow LED goes out

5

M801, M803, M804, M806 Programming

Enter a User Code and Card, Tag, FOB and RF FOB

99# Master Code or Supervisor Code*	Yellow LED blinks
50# (See Table Below)# (User Location 03-2000)#	Yellow LED blinks
User Code (1-6 digits)*	Yellow LED blinks quickly
User Code (1-6 digits)*	Yellow LED blinks slowly
Present Card, Tag, FOB or RF FOB	BEEP / Yellow LED blinks
*	Yellow LED blinks slowly
*	Yellow LED goes out

User Type Table:

0	Passage User
1	Standard User
3	Lockout User
4	Extended Unlock User
5	One Time User
7	Emergency User
8	Communications Enable User
9	Panic User

Note 1: There is a time delay period between initially depressing the RF FOB button and the actuation of the lock. In some cases the RF FOB will have to be depressed (and held for 3 seconds) multiple times to successfully actuate the lock.

Note 2: In the event that there are co-located RF Technology locks using individual RF FOBs that are depressed simultaneously; the locks may not actuate due to cross interference between the locks and the RF FOBs. The "User" should repeatedly depress (and hold for 3 seconds) the RF FOB button until actuation of the lock occurs.

Turn OFF Audible Beep verification on every Key Depression

99# Master Code*	Yellow LED blinks
30# 0# 0# (Off) (1# = On)	Yellow LED blinks
*	Yellow LED blinks quickly
*	Yellow LED blinks slowly
*	Yellow LED goes out

5

M801, M803, M804, M806 Programming

Turn ON Yellow LED verification on every Key Depression

99# Master Code*	Yellow LED blinks
30# 1# 1# (On) (0# = Off)	Yellow LED blinks
*	Yellow LED blinks quickly
*	Yellow LED blinks slowly
*	Yellow LED goes out

Set Time

99# Master Code*	Yellow LED blinks
41# hh:mm# (24hr Format) 0#	Yellow LED blinks
*	Yellow LED blinks quickly
*	Yellow LED blinks slowly
*	Yellow LED goes out

24Hr Format => 1PM = 13:00, 2PM = 14:00.....10PM = 22:00, Midnight = 00:00, 1:15PM = 13:15

Daylight Savings Time

99# Master Code*	Yellow LED blinks
30# 13# 1# (On) (0# = Off)	Yellow LED blinks
*	Yellow LED blinks quickly
*	Yellow LED blinks slowly
*	Yellow LED goes out

Set Date (Today's Date)

99# Master Code*	Yellow LED blinks
42# mmddyy# D.O.W.# (Sunday=1)	Yellow LED blinks
*	Yellow LED blinks quickly
*	Yellow LED blinks slowly
*	Yellow LED goes out

D.O.W. = Day of week

Set Unlock Time

99# Master Code or Supervisor Code*	Yellow LED blinks
11# (1-255 sec.)# 0#	Yellow LED blinks
*	Yellow LED blinks quickly
*	Yellow LED blinks slowly
*	Yellow LED goes out

The Unlock Time is adjustable for momentary operation. A 5 second unlock time is recommended to extend battery life. Once unlock time is entered, it is the same for ALL users except Extended Users.

5

M801, M803, M804, M806 Programming

To Enable/Disable A User

99# Master Code or Supervisor Code*	Yellow LED blinks
56# 0# (Enable) or 1# (Disable) (User No. 03-2000)#	Yellow LED blinks
*	Yellow LED blinks quickly
*	Yellow LED blinks slowly
*	Yellow LED goes out

To Delete A User

99# Master Code or Supervisor Code*	Yellow LED blinks
50# 0# (User Number 03-2000)#	Yellow LED blinks
*	Yellow LED blinks quickly
*	Yellow LED blinks slowly
*	Yellow LED goes out

To Clear the Entire Memory

99# Master Code*	Yellow LED blinks
46# 00000# 00000#	Yellow LED blinks
*	Yellow LED blinks quickly
*	Yellow LED blinks rapidly, slowly when complete
*	Yellow LED goes out

Status Indicators

- No Green LED after code is entered once and 3 rapid beeps, but flashes after 3 consecutive entries – Invalid Code
- 4 Long beeps after Standard code is entered - Low Battery
- 4 Long beeps after Standard code is entered, 4 more long beeps - Voltage (batteries) too low to operate. Enter Master Code or Emergency Code to gain entry.
- 1 beep after User Code entered – Disabled User
- 4 beeps after User Code entered – Deadbolt Thrown (Mortise Lock Only)
- 3 beeps after User Code entered – User Lockout
- Alternating Red/Green LED – Awaiting second entry of Code and Card, Tag, or Fob User

Keypad Programming Instructions

6

Chain Programming

When programming multiple Users and Codes into the M800, M801, M803, M804 and M806 Lock, it is not necessary to leave and re-enter the programming Mode (50) for each entry. Multiple entries may be chained together and the three different types of user codes (Standard, Passage and One Time) may be mixed.

The format to be used is as follows where:

“T” is the Type of user code with “1” = Standard, “0” = Passage and “5” = One Time.

“UL_” is User Location (04-100 for M800 and 03-2000 for all others)

“UC_” is User Code (2 to 6 digits) which correlates with the User Location

99# Master or Supervisor Code* 50# Type# User Location a# User Code a* User Code a*

Type# User Location b# User Code b* User Code b* T# ULc# UCc* UCc* T# ULd#

UCd* UCd* T# UL_# UC_# UC_**

Example with four User Codes:

Type	User Location	User Code
1	05	875
3	12	2226
2	08	5444
1	48	3367

Using Master Code 4732 and above information, the lock would be programmed as follows:

99# 4732* 50# 1# 05# 875* 875* 3# 12# 2226* 2226* 2# 08# 5444* 5444* 1# 48# 3367* 3367*

If all user codes are the type 1, it is not necessary to enter the type number with each entry.

The format now simplifies to:

99# Master or Supervisor Code* 50# User Location a# User Code a* User Code a* ULb#

UCb* UCb* ULc# UCc* UCc* UL_# UC_# UC_**

Example with three User Codes:

Type	User Location	User Code
1	07	77
1	15	67832
1	91	7568

Using Master Code 45988 and above information, the lock would be programmed as follows:

99# 45988* 07# 77* 77* 15# 67832* 67832* 91# 7568* 7568**

To chain the User Location delete procedure:

99# Master Code* User Location a#** ULb#** ULc#** UL_#****

Using the information from the above example:

99# 45988* 07#** 15#** 91#****

7

M802 and M805 Programming

In a Prox Only M802 or RF Technology & Prox M805 configuration, all programming must be completed using Accessware™ Software. The Software includes a convenient Software User's Manual in .pdf format to be used as a programming guide. After setting up your system using the software, Hotsync to the PDA. Be sure to program a "Communications Enable" credential for future programming.

To program the lock for the first time or after memory is reset, the following steps are required.

1. Use Accessware™ software to set up your system and Hotsync door information to PDA.
2. Remove Battery Cover from inside of lock.
3. On PDA - select "Access HH", then "Imp/Exp"
"Do **NOT** click OK at this point" PDA Response: "Please enter your communications code at the door"
4. "Wake up" the M802 or M805 lock by presenting any HID Prox Credential or by depressing an RF FOB Lock Response: Audible beep
5. Within a couple seconds press and hold the controller CommEnable push button (white button located in the battery compartment) for 2 seconds, then release the button.
6. On the PDA, click "OK" The PDA will begin transferring (0-100%) of the door data to the lock.

If there was an error, check connections and repeat process starting at Step 3.

Note: The Credential will NOT actuate the lock for 45 seconds from the start of the downloading process. After this time expires, the Credential will function as defined by its User Type.

Reprogramming

Note: Using the proximity card, FOB, tag or RF FOB programmed as a "CommEnable" User, present the "CommEnable" credential to the lock to initiate communications after performing Step 3 (above) without the need to press the CommEnable button.

Corbin Russwin
225 Episcopal Road
Berlin, CT 06037
Phone: 800-543-3658
Fax: 800-447-6714
corbinrusswin.com

ASSA ABLOY is the global
leader in door opening solutions,
dedicated to satisfying
end-user needs for security,
safety and convenience

Copyright © 2018-2019 Corbin Russwin, Inc., an ASSA ABLOY Group company. All rights reserved. Reproduction in whole or in part without the express written permission of Corbin Russwin, Inc. is prohibited.

Patent pending and/or patent: www.assaabloydss.com/patents

For installation assistance contact Corbin Russwin
1-800-543-3658 • techsupport.corbinrusswin@assaabloy.com