



Padlocks & Deadlocks

Product Catalog

Experience a safer
and more open world

Introduction

Padlocks & Deadlocks



Applications

Corbin Russwin Auxiliary Locks provide security for a wide range of applications. Our auxiliary and special purpose locks including padlocks and deadlocks allow end users to meet specific security needs.

Table of Contents

Introduction 2

Padlocks PL5000 Series

Features 3
 Ordering Examples 4
 Quick Codes 4

Deadlocks DL2200/ DL3200 Series

Features 5
 Functions 5
 Strikes 5
 Indicators 6
 Ordering Examples 7
 Cylinders 7
 Quick Codes 8

Deadlocks DL3000 Series

Features 9
 Functions 9
 Strikes 9
 Ordering Examples 10
 Quick Codes 10-11

Deadlocks DL4100 Series

Features 12
 Functions 12
 Strikes 13
 Thumbturns 13
 Ordering Examples 14
 Quick Codes 14-15

www.corbinrusswin.com

PL5000 Series Padlocks

Rekeyable Fixed Core (RFC) and Large Format Interchangeable Core (LFIC) Models

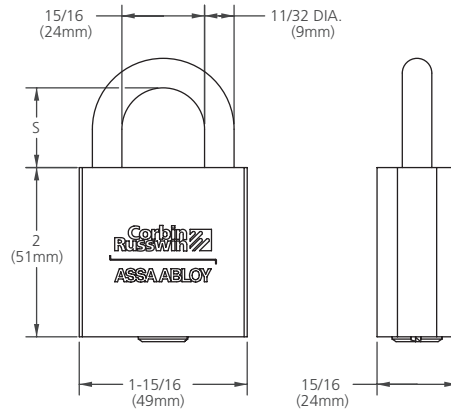

Model	Series	Shackle Clearance S
RFC	PL5000R PL5100R PL5200R	Std: 7/8" (22mm) 258: 2-5/8" (67mm)
LFIC	PL5070 PL5170 PL5270	

Padlock Parts	
756F963	Throw member for LFIC & RFC padlocks (A)
793F592 (606 finish)	Cylinder sleeve for RFC padlocks (B)
438F41-8	Mounting screw for RFC padlocks (C)

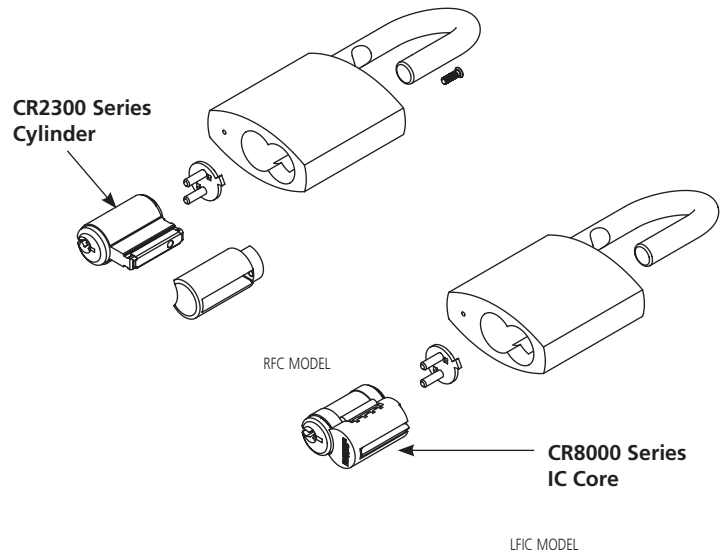

Features

Case

Extruded brass.

Shackle

11/32" (9mm) diameter hardened steel (PL5000 Series), brass (PL5100 Series) or stainless steel (PL5200 Series).

Locking

Ball-bearing locking heel and toe.

Cylinder

RFC model: 6-pin Fixed Core (CR2300)
LFIC model: 6-Pin, Security, Pyramid & Access 3 (CR8000 Series)
L4 keyway standard

Keying Features Available

Master keying
Construction master keying
Interchangeable core (LFIC) 6-pin
LFIC security
Concealed key control
Visual key control (not for HS)
Pyramid (LFIC only)
Access 3® (LFIC only)

Keys

Two nickel silver standard.

Warranty

One-year limited.

Finish

BHMA 606 Satin Brass (US4) only.

PL5000 Series

Padlocks

Ordering Examples

Stock Order

Quantity	Series/Function
10	PL5000R

Contract/Detailed Order

Quantity	Keypad	Series/Function	Shackle Length	Misc. Options
4	AJ3	PL5080	258	M45 x S19866

Quick Codes

Series/Function

Description	Series/Function		
	Hardened Steel Shackle	Brass Shackle	Stainless Steel Shackle
Rekeyable Fixed Core (RFC)	PL5000R	PL5100R	PL5200R
Large Format Interchangeable core (LFIC) less core	PL5070	PL5170	PL5270
LFIC 6-pin	PL5080	PL5180	PL5280
LFIC security	PL5090	PL5190	PL5290
Pyramid High Security (LFIC)	PL5030	PL5130	PL5230
Pyramid Security (LFIC)	PL5037	PL5137	PL5237

Miscellaneous Options

Description	Specify
Chain and clevis attached	M44
Custom die stamped case (specify existing die number, or provide lettering specifications or artwork)	M45 x #

Cylinder Only

Description	Specify
Removable Core	
Standard 6-pin	CR2300
Large Format Interchangeable Core	
Standard 6-pin	CR8000
Security	CR8010
Pyramid High Security	CR8020
Pyramid Security	CR8027
Access 3® - Patented	CR8500
Access 3® - Security	CR8600
Access 3® - High Security	CR8700

Cylinder and Keying

Description	Specify
Keyed Random (standard for Pyramid & LFIC security padlocks)	KR
0-bitted (not available for Pyramid & LFIC security padlocks)	(standard)
Construction Master Keyed (RFC & LFIC 6-pin padlocks only)	CMK
Temporary Construction Core (Red) (LFIC 6-pin padlocks only)	CT6R
Temporary Construction Core (Blue) (LFIC 6-pin padlocks only)	CT6B
Temporary Construction Core (Green) (LFIC 6-pin padlocks only)	CT6G
Visual Key Control (VKC)	
- Keys only	VKC1
- Locks and keys (RFC & LFIC 6-pin padlocks only)	VKC2
- Locks only (RFC & LFIC 6-pin padlocks only)	VKC3
Concealed Key Control (CKC) (LFIC 6-pin & LFIC security padlocks only)	
- CKC cores and VKC keys	CKC2
- CKC cores only	CKC3
2 keys per lock	(standard)
More than 2 keys	KY# (e.g., KY6)
Rekeyable FC (RFC) Less Cylinder	LC
Access 3® Patented LFIC	ACP
Access 3® Security LFIC	ACS
Access 3® High Security LFIC	ACHS

Shackle Clearance

Description	Specify
7/8" (22mm)	(standard)
2-5/8" (67mm)	258

DL2200/DL3200 Series

Deadlocks

Features

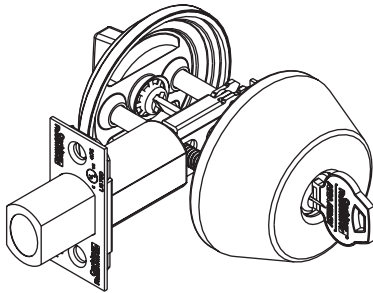

Handing Non-handed.

Door Thickness Standard: 1-3/4" (44mm). Optional door thicknesses available; see Quick Codes.

Backset Standard: 2-3/4" (70mm)
Optional: 2-3/8" (60mm)

Front Standard: brass or stainless steel, 2-1/4" (57mm) x 1-1/8" (29mm).
Optional: 1" width; see Quick Codes.

Deadbolt 1" throw, solid steel deadbolt with hardened, free spinning, steel pin insert.

Strike Standard; 2-3/4" (70mm) x 1-1/8" (29mm). Optional strikes and wrought boxes available; see Strikes, this page.

Cylinder Standard: brass, 6-pin, L4 keyway, 0-bitted. Security cylinder optional; see Quick Codes.

Keys Two nickel silver standard.

Keying Features Available

Master keying
Construction master keying
Security
Visual key control
Concealed key control

Warranty One-year limited.

Certification/Compliance

UL

UL10B/UL10C Fire Rated Auxiliary Lock for A label and lesser class doors when used with a correspondingly rated primary latching device.

ANSI/BHMA

DL2200 - A156.36 Certified Grade 2
DL3200 - A156.36 Certified Grade 1



Any retrofit or other field modification to a fire rated opening can potentially impact the fire rating of the opening, and Corbin Russwin, Inc. makes no representations or warranties concerning what such impact may be in any specific situation. When retrofitting any portion of an existing fire-rated opening, or specifying and installing a new fire-rated opening, please consult with a code specialist or local code official (Authority Having Jurisdiction) to ensure compliance with all applicable codes and ratings.

Functions

Outside	Inside	Series/ Function	Type	ANSI No.	Function Description
		DL2213 DL3213	Single Cylinder	E0150 Series	- By key outside and by thumbturn inside.
		DL2212 DL3212	Double Cylinder	E0140 Series	- By key either side.
		DL2217 DL3217	Classroom	E0170 Series	- By key outside and by thumbturn inside. - Thumbturn will retract but not project deadbolt.
		DL2211 DL3211	Cylinder x Blank	E0160 Series	- By key one side only; opposite side blank.
		DL2260 DL3260	Thumbturn x Blank	E0190 Series	- By thumbturn one side only; opposite side blank.
		DL2261	Thumbturn x Indicator	E01112	- By thumbturn inside, emergency override key outside. - Indicator standard for both sides, specify indicator option code.

Strikes



Metal Frame Strike

Standard
2-3/4" (70mm) x 1-1/8" (29mm).
To order separately, specify 781F568 x Finish



Wood Frame Strike

Standard
2-3/4" (70mm) x 1-1/8" (29mm).
To order separately, specify 781F558 x Finish.



Strike Box

Standard with standard strikes.
To order separately, specify 781F599.



ANSI Strike

Optional; see Quick Codes.
To order separately, specify 423L71 x Finish.

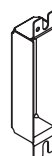

ANSI Wrought Strike Box

Optional for use with ANSI strike; see Quick Codes. To order separately, specify 120F768.

DL2200 Series

Indicators

Available on the DL2200 Series, ANSI/BHMA Grade 2, deadbolts, status indicators can be used in a variety of applications and are most commonly used to identify occupancy status of a room.

With indicator option codes that are designed to convey wording and color in one simple code, indicators are provided on the DL2213 function as an option, and standard on both sides for the DL2261 function. Indicator option codes must be specified when ordering.

Note: Oversized thumbturn standard on indicator functions only. Other functions available by special application. Contact customer service for more details.



Features:

- Multiple indicator windows
- Large indicator windows
- Color, wording and symbols
- Options for wording/color
- Oversized thumbturn
- Patent pending thumbturn indicator
- Handed and field reversible

Applications:

- Restrooms
- Quiet rooms
- Nursing mother's rooms

Indicator Option Codes

Single Indicator (Available for DL2213)			
Option Code	Outside Wording	Inside Wording	Color
V01	No Indicator	Unlocked/Locked	Green/Red
V01F	No Indicator	Ouvert/Fermé	Green/Red
V04	No Indicator	Unlocked/Locked	White/Red
Double Indicator (Available for DL2261)			
Option Code	Outside Wording	Inside Wording	Color
V21*	Vacant/Occupied	Unlocked/Locked	Green/Red
V21F	Libre/Occupée	Ouvert/Fermé	Green/Red
V54	Vacant/Occupied	Unlocked/Locked	White/Red

UNLOCKED	LOCKED	VACANT	OCCUPIED
UNLOCKED	LOCKED		
OVERT	FERMÉ	LIBRE	OCCUPÉE
OVERT	FERMÉ		
UNLOCKED	LOCKED	VACANT	OCCUPIED
UNLOCKED	LOCKED		

* V21 provided standard for DL2261 unless otherwise specified

DL2200/DL3200 Series

Deadlocks

Ordering Examples

Stock Order

Quantity	Series/Function	Finish
24	DL2213	626

Contract/Detailed Order

Quantity	Keylet	Series/Function	Finish	Strike	Options
24	AA1	DL2213	626	SS078	HS-CKC2

Cylinders

Cylinder Only (less housing)

Function	Part Number	Cylinder Type	Door Thickness
11,13,17	CR4400-134-A51	6-Pin Conventional	1-3/8" (35mm) 1-3/4" (44mm) 2" (51mm) 2-1/4" (57mm)
	CR4400-134-A51-7	7-Pin Conventional	
	CR4410-134-A51	Security	
	CR4420-134-A51	Pyramid High Security	
	CR4427-134-A51	Pyramid Security	
	CR4500-134-A51	Access 3® Patented	
	CR4600-134-A51	Access 3® Security	
12	CR4700-134-A51	Access 3® High Security	1-3/8" (35mm) 1-3/4" (44mm) 2" (51mm) 2-1/4" (57mm)
	CR4400-134-A52	6-Pin Conventional	
	CR4400-134-A52-7	7-Pin Conventional	
	CR4410-134-A52	Security	
	CR4420-134-A52	Pyramid High Security	
	CR4427-134-A52	Pyramid Security	
	CR4500-134-A52	Access 3® Patented (AP)	
	CR4600-134-A52	Access 3® Security (AS)	
	CR4700-134-A52	Access 3® High Security (AHS)	
	CR4400-214-A52	6-Pin Conventional	
	CR4400-214-A52-7	7-Pin Conventional	
	CR4410-214-A52	Security	
	CR4420-214-A52	Pyramid High Security	
	CR4427-214-A52	Pyramid Security	
CR4500-214-A52	Access 3® Patented (AP)		
CR4600-214-A52	Access 3® Security (AS)		
CR4700-214-A52	Access 3 High Security (AHS)		
11,12,13,17	CR8000	6-Pin LFIC	See the Housing Assembly for Interchangeable Core Cylinder chart below.
	CR8000-7	7-Pin LFIC	
	CR8010	Security LFIC	
	CR8020	Pyramid High Security LFIC	
	CR8027	Pyramid Security LFIC	
	CR8200	6-pin SFIC	
	CR8200-7	7-pin SFIC	
	CR8500	Access 3® Patented LFIC	
	CR8600	Access 3® Security LFIC	
	CR8500	Access 3® High Security LFIC	

Housing Assembly - Interchangeable Core Cylinder

Function	Part Number	Accepts Core	Door Thickness
11,13,17	CR4440-134-A51	6 & 7 Pin SFIC	1-3/8" (35mm) 1-3/4" (44mm) 2" (51mm) 2-1/4" (57mm)
	CR4470-134-A51	6-Pin LFIC	
	CR4470-134-A51-7	7-Pin LFIC	
12	CR4440-138-A52-XX (*)	6 & 7 Pin SFIC	1-3/8" (35mm)
	CR4470-138-A52-XX	6-Pin LFIC	
	CR4470-138-A52-7-XX	7-Pin LFIC	
	CR4440-134-A52-XX	6 & 7 Pin SFIC	1-3/4" (44mm)
	CR4470-134-A52-XX	6-Pin LFIC	
	CR4470-134-A52-7-XX	7-Pin LFIC	2" (51mm)
	CR4440-200-A52-XX	6 & 7 Pin SFIC	
	CR4470-200-A52-XX	6-Pin LFIC	
	CR4470-200-A52-7-XX	7-Pin LFIC	
	CR4440-214-A52-XX	6 & 7 Pin SFIC	2-1/4" (57mm)
CR4470-214-A52-XX	6-Pin LFIC		
CR4470-214-A52-7-XX	7-Pin LFIC		

(*) Specify "OS" for outside of door or "IS" for inside of door.

DL2200/DL3200 Series

Deadlocks

Quick Codes

Cylinder and Keying

Description	Specify
Conventional 6-pin	(standard)
Less Cylinder(s)	LC
Conventional 7-pin	7P
LFIC	
LFIC 6-pin	C6
LFIC 6-pin Less Core	CL6
LFIC 6-pin with Temporary Disposable Core	CT6D
LFIC 6-pin with Temporary Construction Core (Red)	CT6R
LFIC 6-pin with Temporary Construction Core (Blue)	CT6B
LFIC 6-pin with Temporary Construction Core (Green)	CT6G
LFIC 7-pin	C7
LFIC 7-pin Less Core	CL7
LFIC 7-pin with Temporary Disposable Core	CT7D
LFIC 7-pin with Temporary Construction Core (Red)	CT7R
LFIC 7-pin with Temporary Construction Core (Blue)	CT7B
LFIC 7-pin with Temporary Construction Core (Green)	CT7G
SFIC	
SFIC 6-pin	C6S
SFIC 6-pin Less Core	CLS6
SFIC 6-pin with Temporary Construction Core (Blue)	CT6SB
SFIC 7-pin	C7S
SFIC 7-pin Less Core	CLS7
SFIC 7-pin with Temporary Construction Core (Blue)	CT7SB
SFIC 6- or 7-pin Small Format Disposable Core	CTSD
Security	
Security	HS
Security LFIC	CHS
Access 3®	
Access 3® Patented Fixed Core	AP
Access 3® Security Fixed Core	AS
Access 3® High Security Fixed Core	AHS
Access 3® Patented LFIC	ACP
Access 3® Security LFIC	ACS
Access 3® High Security LFIC	ACHS
Pyramid	
Pyramid High Security Fixed Core	PHS
Pyramid High Security LFIC	PCHS
Pyramid Security Fixed Core	PS
Pyramid Security LFIC	PCS
Keying and Keys	
0-bitted with 2 blank keys	(standard)
Keyed Random	KR
Construction Master Keyed (not available for Pyramid & Security cylinders)	CMK
2 keys per lock	(standard)
More than 2 keys (e.g., KY6)	KY#
Visual key control (VKC)	
Keys only	VKC1
Cylinders and keys (not for AS, AHS, ACS, ACHS, HS, CHS, PHS or PCHS)	VKC2
Cylinders only (not for AS, AHS, ACS, ACHS, HS, CHS, PHS or PCHS)	VKC3
Concealed key control (CKC)	
CKC cylinders and VKC keys	CKC2
CKC cylinders only (not for AS, AHS, ACS, ACHS, PHS, PCHS)	CKC3

Strike

Lip to Center	ANSI Straight Lip Specify
7/8" (22mm)	SS078
1-1/8" (29mm)	SS118
1-1/4" (32mm)	SS114
1-3/8" (35mm)	SS138
1-1/2" (38mm)	SS112
1-3/4" (44mm)	SS134
2" (51mm)	SS200
2-1/4" (57mm)	SS214
2-1/2" (64mm)	SS212
2-3/4" (70mm)	SS234
3" (76mm)	SS300

Finish

Description	Specify
US3 Bright Brass	605
US4 Satin Brass	606
US10 Satin Bronze	612
US10B Dark Oxidized Satin Bronze, oil rubbed	613
US10BE Dark Oxidized Satin Bronze - equivalent	613E
US26 Bright Chromium Plated	625
US26D Satin Chromium Plated	626
— Black Suede Powder Coat	BSP
— White Suede Powder Coat	WSP

Lock/Cylinder Finish

Lock	Cylinder/Core*
605,606, 612,613,613E	606
625,626,WSP	626
BSP	BSP

*Finish when cylinder provided with lock

Door Thickness

Description	Specify
1-3/8" (35mm)	D138
1-3/4" (44mm)	(standard)
2" (51mm)	D200**
2-1/4" (57mm)	D214**

** Special application required for use with DL2261, contact Technical Product Support

Miscellaneous Options

Description	Specify
ANSI wrought strike box	M17
Plastic box for standard strike	(standard)

Bolt Assembly

Description	Part No.	Specify
2-3/8" (60mm) Backset	781F528	B238
2-3/4" (70mm) Backset	781F538	(standard)
Front Trim Plates		
1" (25mm) Wide	781F50M x Finish	M14
1-1/8" (29mm) Wide	781F51M x Finish	(standard)

DL3000 Series

Deadlocks

Features

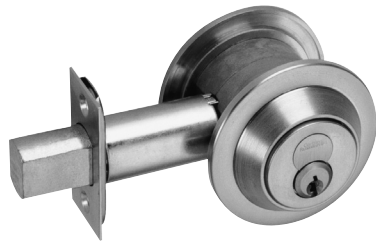

Handing

Non-handed, except DL3017, which is handed and field reversible.

Door Thickness

Standard: 1-3/4" (44mm) - 2-1/4" (57mm).
Optional door thicknesses available; see Quick Codes.

Backset

Standard: 2-3/4" (70mm)
Optional: 2-3/8" (60mm)

Front

Standard: wrought brass or bronze, 2-1/4" (57mm) x 1-1/8" (29mm).
Accommodates flat doors and doors with beveled 1/8" (3mm) in 2" (51mm).

Deadbolt

Zinc diecast hardened steel insert. 1" (25mm) throw, 5/8" (16mm) wide x 3/4" (19mm) high.

Strike

Standard; 2-3/4" (70mm) x 1-1/8" (29mm).
Optional strikes and wrought boxes available; see Strikes, this page.

Cylinder

Brass, 6-pin, L4 keyway, 0-bitted. Security cylinders optional; see Quick Codes.

Keys

Two nickel silver standard.

Keying Features Available

- Master keying
- Construction master keying
- 7-pin (FC) conventional
- Interchangeable core (LFIC or SFIC)
- Security
- Security (LFIC)
- Visual key control
- Concealed key control
- Pyramid (FC)
- Pyramid (LFIC)

Warranty

One-year limited.

Functions

Outside	Inside	Series/Function	Type	ANSI No.	Function Description
		DL3013	Single Cylinder	E0150 Series	- By key outside and by thumbturn inside.
		DL3012	Double Cylinder	E0140 Series	- By key either side.
		DL3017	Classroom	E0170 Series	- By key outside and by thumbturn inside. - Thumbturn will retract but not project deadbolt.
		DL3011	Cylinder x Blank	E0160 Series	- By key one side only; opposite side blank.
		DL3060	Thumbturn x Blank	E0190 Series	- By thumbturn one side; opposite side blank.

Strikes



Standard Strike

2-3/4" (70mm) x 1-1/8" (29mm).
To order separately, specify 424F83 x Finish.



ANSI Strike

Optional; see Quick Codes.
To order separately, specify 423L71 x Finish.



Wrought Strike Box

Standard with Standard Strike.
To order separately, specify 496F71-8.

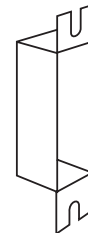

ANSI Wrought Strike Box

Optional for use with ANSI Strike; see Quick Codes.
To order separately, specify 120F76-8.



Optional Strike

3-1/2" (89mm) x 1-1/8" (29mm); see Quick Codes.
To order separately, specify 394F19 x Finish.

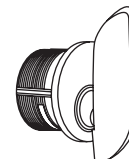

Optional Thumbturn

Large profile and offset center thumbturn makes it easier to grasp and rotate. To order specify Quick Code M34. Available for DL3013, DL3017, DL3060.

Note: Large Format Interchangeable core not available with 1-3/8" door thickness (D138) option and 2-3/8" backset (B238) option.

DL3000 Series

Deadlocks

Ordering Examples

Stock Order

Quantity	Series/Function	Finish
24	DL3013	626

Contract/Detailed Order

Quantity	Keyset	Series/Function	Finish	Optional Strike	Door Thickness	Misc. Options
24	AA1	DL3013	613	SS118	D214	C6-M17

Quick Codes

Finish

	Description	Specify
US3	Bright Brass	605
US4	Satin Brass	606
US10	Satin Bronze	612
US10B	Dark Oxidized Satin Bronze, oil rubbed	613
US10BE	Dark Oxidized Satin Bronze - equivalent	613E
US26	Bright Chromium Plated	625
US26D	Satin Chromium Plated	626
—	Black Suede Powder Coat	BSP
—	White Suede Powder Coat	WSP

Strike

Lip to Center	ANSI Straight Lip Specify
7/8" (22mm)	SS078
1-1/8" (29mm)	SS118
1-1/4" (32mm)	SS114
1-3/8" (35mm)	SS138
1-1/2" (38mm)	SS112
1-3/4" (44mm)	SS134
2" (51mm)	SS200
2-1/4" (57mm)	SS214
2-1/2" (64mm)	SS212
2-3/4" (70mm)	SS234
3" (76mm)	SS300
Other Strikes (no lip)	Specify
2-3/4" (70mm) x 1-1/8" (29mm)	(standard)
3-1/2" (89mm) x 1-1/8" (29mm)	SD001

Door Thickness

Description	Specify
1-3/4" (44mm) - 2" (51mm)	(standard)
2-1/4" (57mm)	D214
1-3/8" (35mm)	D138

Miscellaneous Options

Description	Specify
ANSI wrought strike box	M17
Ergonomic Thumbturn	M34
Wrought box for standard strike	(standard)

DL3000 Series

Deadlocks

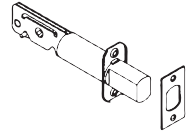

Quick Codes (cont.)

Cylinder and Keying

Description	Specify
Conventional 6-pin	(standard)
Less Cylinder(s)	LC
Conventional 7-pin	7P
LFIC	
LFIC 6-pin	C6
LFIC 6-pin Less Core	CL6
LFIC 6-pin with Temporary Disposable Core	CT6D
LFIC 6-pin with Temporary Construction Core (Red)	CT6R
LFIC 6-pin with Temporary Construction Core (Blue)	CT6B
LFIC 6-pin with Temporary Construction Core (Green)	CT6G
LFIC 7-pin	C7
LFIC 7-pin Less Core	CL7
LFIC 7-pin with temporary disposable core	CT7D
LFIC 7-pin with Temporary Construction Core (Red)	CT7R
LFIC 7-pin with Temporary Construction Core (Blue)	CT7B
LFIC 7-pin with Temporary Construction Core (Green)	CT7G
SFIC	
SFIC 6-pin	C6S
SFIC 6-pin Less Core	CLS6
SFIC 6-pin with Temporary Construction Core (Blue)	CT6SB
SFIC 7-pin	C7S
SFIC 7-pin Less Core	CLS7
SFIC 7-pin with Temporary Construction Core (Blue)	CT7SB
SFIC 6- or 7-pin Small Format Disposable Core	CTSD
Security	
Security	HS
Security LFIC	CHS
Access 3®	
Access 3® Patented Fixed Core	AP
Access 3® Security Fixed Core	AS
Access 3® High Security Fixed Core	AHS
Access 3® Patented LFIC	ACP
Access 3® Security LFIC	ACS
Access 3® High Security LFIC	ACHS
Pyramid	
Pyramid High Security Fixed Core	PHS
Pyramid High Security LFIC	PCHS
Pyramid Security Fixed Core	PS
Pyramid Security LFIC	PCS
UL Housing	
LFIC 6-pin Less Core	CL6AH
LFIC 6-Pin Disposable Core	CTAHD
LFIC 6-pin with Temporary Construction Core (Red/Blue/Green)	CT6AH (R/B/G)
Keying and Keys	
0-bitted with 2 blank keys	(standard)
Keyed Random	KR
Construction Master Keyed (not available for Pyramid & Security cylinders)	CMK
2 keys per lock	(standard)
More than 2 keys (e.g., KY6)	KY#
Visual key control (VKC)	
Keys only	VKC1
Cylinders and keys (not for AS, AHS, ACS, ACHS, HS, CHS, PHS or PCHS)	VKC2
Cylinders only (not for AS, AHS, ACS, ACHS, HS, CHS, PHS or PCHS)	VKC3
Concealed key control (CKC)	
CKC cylinders and VKC keys	CKC2
CKC cylinders only (not for AS, AHS, ACS, ACHS, PHS, PCHS)	CKC3

Bolt and Front

Description	Part No.	Specify
2-3/4" (70mm) backset bolt (less front)	467F35-8	(standard)
2-3/8" (60mm) backset bolt (less front)	693F20-8	B238
1-1/8" (29mm) front	467F36	—

Cylinder Only

Specify Part No. x Keyway x Finish

Description	Number
Conventional 6-pin	CR1000-118-A03
Conventional 7-pin	CR1000-114-A03-7
LFIC 6-pin	CR1080-114-A03
LFIC 6-pin less core	CR1070-114-A03
LFIC 7-pin	CR1080-114-A03-7
LFIC 7-pin less core	CR1070-114-A03-7
SFIC 6-pin	CR1050-114-A03
SFIC 6-pin	CR1040-114-A03
SFIC 7-pin	CR1050-114-A03-7
SFIC 7-pin	CR1040-114-A03-7
Security	CR1010-118-A03
Security LFIC	CR1090-114-A03
Pyramid (FC) Conventional	CR1020-114-A03
Pyramid (LFIC)	CR1030-114-A03
Access 3 Patented Fixed Core	CR1500-114-A03
Access 3 Security Fixed Core	CR1600-114-A03
Access 3 High Security Fixed Core	CR1700-114-A03
Access 3 Patented Interchangeable Core	CR1580-114-A03
Access 3 Security Interchangeable Core	CR1680-114-A03
Access 3 High Security Interchangeable Core	CR1788-114-A03
Access 3 UL 6-Pin Housing	CR1078-114-A03

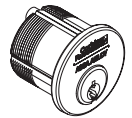

DL4100 Series

Deadlocks

Features

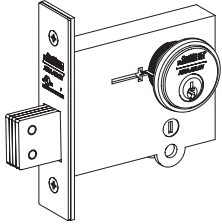

Handing

Non-handed.

Door Thickness

Standard: 1-3/4" (44mm). Optional door thicknesses available; see Quick Codes.

Backset

2-3/4" (70mm).

Lockcase

Heavy wrought steel; zinc dichromate finish.

Front

Brass, bronze, stainless steel.
4-5/8" (117mm) x 1-1/8" (29mm).
Adjustable for flat or beveled doors (bevel adjustment 1/8" (3mm) in 2" (51mm)).

Deadbolt

Laminated stacked steel with hardened pin, 1" (25mm) throw.

Strike

Standard: wrought brass or bronze,
3-1/2" (89mm) x 1-1/8" (29mm).
Optional strikes available; see Strikes,
next page.

Cylinder

6-pin, L4 keyway, 0-bitted. Security
cylinder optional; see Quick Codes.

Keys

Two nickel silver standard.

Keying Features Available

Master keying
Construction master keying
7-pin (FC) conventional
Interchangeable core (LFIC or SFIC)
Security
Security (LFIC)
Visual key control
Concealed key control
Pyramid (FC)
Pyramid (LFIC)

Warranty

One-year limited.







Certification/Compliance

UL

Listed for use on fire doors.

Any retrofit or other field modification to a fire rated opening can potentially impact the fire rating of the opening, and Corbin Russwin, Inc. makes no representations or warranties concerning what such impact may be in any specific situation. When retrofitting any portion of an existing fire-rated opening, or specifying and installing a new fire-rated opening, please consult with a code specialist or local code official (Authority Having Jurisdiction) to ensure compliance with all applicable codes and ratings.

Functions

Outside/Inside	Series/ Function	Type	ANSI No.	Function Description
	DL4113	Single Cylinder	E6070 Series	- By key outside and by thumbturn inside.
	DL4112	Double Cylinder	E6060 Series	- By key either side.
	DL4117	Classroom	E6090 Series	- By key outside and by thumbturn inside. - Thumbturn will retract but not project deadbolt.
	DL4111	Cylinder x Blank	E6080 Series	- By key one side only; opposite side blank.
	DL4122	Double Cylinder x Thumbturn	—	- By key either side and by thumbturn inside. - Thumbturn will retract but not project deadbolt.
	DL4160	Thumbturn x Blank	—	- By thumbturn inside only; opposite side blank.

DL4100 Series

Deadlocks

Strikes



Standard Strike

3-1/2" (89mm) x 1-1/8" (29mm). To order separately, specify 796F34 x Finish.

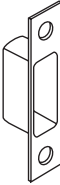

Strike Box

Optional with Standard Strike; see Quick Codes. To order separately, specify 466F27-9.



ANSI Strike

Optional; see Quick Codes. To order separately, specify 240L08 x Finish.



ANSI Wrought Strike Box

Optional for use with ANSI Strike; see Quick Codes. To order separately, specify 120F76-8.

Thumbturns

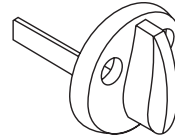

Standard Thumbturn

Cast brass or bronze. Standard on functions utilizing thumbturn. Surface screw mounted. To order separately, see table.

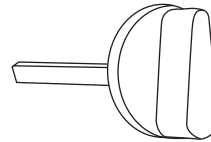

Optional Thumbturn

Large profile and offset center thumbturn makes it easier to grasp and rotate. To order with lock, specify Quick Code M34. To order separately, see table.

Door	Packet	
	Standard	Optional
1-3/4" (44mm)	796F30M x FIN	791F51M x FIN
2" (51mm)	857F45M x FIN	
2-1/4" (57mm)	857F46M x FIN	

DL4100 Series

Deadlocks

Ordering Examples

Stock Order

Quantity	Series/Function	Finish
24	DL4113	626

Contract/Detailed Order

Quantity	Keyset	Series/Function	Finish	Optional Strike	Door Thickness	Misc. Options
7	AA13	DL4112	626	SS118	D214	C6-VKC2

Quick Codes

Cylinder and Keying

Description	Specify
Conventional 6-pin	(standard)
Conventional 7-pin	7P
Less Cylinder(s)	LC
LFIC	
LFIC 6-pin	C6
LFIC 6-pin Less Core	CL6
LFIC 6-Pin Disposable Core	CT6D
LFIC 6-pin with Temporary Construction Core (Red)	CT6R
LFIC 6-pin with Temporary Construction Core (Blue)	CT6B
LFIC 6-pin with Temporary Construction Core (Green)	CT6G
LFIC 7-pin	C7
LFIC 7-pin Less Core	CL7
LFIC 7-Pin Disposable Core	CT7D
LFIC 7-pin with Temporary Construction Core (Red)	CT7R
LFIC 7-pin with Temporary Construction Core (Blue)	CT7B
LFIC 7-pin with Temporary Construction Core (Green)	CT7G
SFIC	
SFIC 6-pin	C6S
SFIC 6-pin Less Core	CLS6
SFIC 6-Pin Disposable Core	CT6SD
SFIC 6-pin with Temporary Construction Core (Blue)	CT6SB
SFIC 7-pin	C7S
SFIC 7-pin Less Core	CLS7
SFIC 7-Pin Disposable Core	CT7SD
SFIC 7-pin with Temporary Construction Core (Blue)	CT7SB
Security	
Security	HS
Security LFIC	CHS
Access 3*	
Access 3* Patented Fixed Core	AP
Access 3* Security Fixed Core	AS
Access 3* High Security Fixed Core	AHS
Access 3* Patented LFIC	ACP
Access 3* Security LFIC	ACS
Access 3* High Security LFIC	ACHS
Pyramid	
Pyramid Security Fixed Core	PS
Pyramid High Security Fixed Core	PHS
Pyramid Security LFIC	PCS
Pyramid High Security LFIC	PCHS
Pyramid LFIC Less Core	CLP
Pyramid with Temporary Construction Core	CTP
Pyramid Disposable Core	CTPD

Description	Specify
UL Housing	
LFIC 6-pin Less Core	CL6AH
LFIC 6-Pin Disposable Core	CTAHD
LFIC 6-pin with Temporary Construction Core (Red/Blue/Green) ³	CT6AH (R/B/G)
Other	
Master Ring	MR
Flex Head Cylinder, 6-pin (sectional trim)	FX6
Flex Head Cylinder, 7-pin (sectional trim)	FX7
Flex Head Cylinder, Master Ring (sectional trim)	FXM
Plug Only to Show, Less Cylinder	PO-LC
Plug Only to Show, 6-pin (concealed shell; M and R escutcheons only, single cylinder only)	PO6
Plug Only to Show, 7-pin (concealed shell; M and R escutcheons only, single cylinder only)	PO7
Keying and Keys	
0-bitted with 2 blank keys	0Bit (standard)
Keyed Random	KR
Construction Master Keyed (not available for Pyramid)	CMK
Uncombined	UC
2 keys per lock	(standard)
More than 2 keys	KY# (e.g., KY6)
Visual key control (VKC)	
No biting or keyset stamping on keys or cylinder	VKC0
Keys only	VKC1
Cylinders and keys (not for AS, AHS, ACS, ACHS, HS, CHS, PHS or PCHS)	VKC2
Cylinders only (not for AS, AHS, HS, ACS, ACHS, CHS, PHS or PCHS)	VKC3
Concealed key control (CKC)	
CKC cylinders with VKC keys	CKC2
CKC cylinders only (not for AS, AHS, HS, ACS, ACHS, CHS, PHS or PCHS)	CKC3

DL4100 Series

Deadlocks

Finish

	Description	Specify
BHMA 605 (US3)	Bright Brass	605
BHMA 606 (US4)	Satin Brass	606
BHMA 611 (US9)	Bright Bronze	611
BHMA 612 (US10)	Satin Bronze	612
BHMA 613 (US10B)	Dark Oxidized Satin Bronze, Oil Rubbed	613
BHMA 613E (US10BE)	Dark Oxidized Satin Bronze - equivalent	613E
613L	Dark Oxidized Satin Bronze, Clear Coated	613L
BHMA 618 (US14)	Bright Nickel	618
BHMA 619 (US15)	Satin Nickel	619
BHMA 625 (US26)	Bright Chromium Plated	625
BHMA 626 (US26D)	Satin Chromium Plated	626
—	Black Suede Powder Coat	BSP
—	White Suede Powder Coat	WSP

Strike

Lip to Center	ANSI Straight Lip Specify
7/8" (22mm)	SS078
1-1/8" (29mm)	SS118
1-1/4" (32mm)	SS114
1-3/8" (35mm)	SS138
1-1/2" (38mm)	SS112
1-3/4" (44mm)	SS134
2" (51mm)	SS200
2-1/4" (57mm)	SS214
2-1/2" (64mm)	SS212
2-3/4" (70mm)	SS234
3" (76mm)	SS300

Miscellaneous Options

Description	Specify
Spanner head screws	M02
Torx® head screws	M04
ANSI wrought strike box	M17
Lead wrapped case	M29
Ergonomic thumbturn	M34
Box for standard strike	M40

Door Thickness

Description	Specify
1-3/4" (44mm) - 2" (51mm)	(standard)
2-1/4" (57mm)	D214

Cylinder Only

Specify Part No. x Keyway x Finish

Description	Number
Conventional 6-pin	CR1000-118-A07
Conventional 7-pin	CR1000-114-A07-7
LFIC 6-pin	CR1080-114-A07
LFIC 6-pin less core	CR1070-114-A07
LFIC 7-pin	CR1080-112-A07-7
LFIC 7-pin less core	CR1070-112-A07-7
SFIC 6-pin	CR1050-114-A07-6
SFIC 6-pin less core	CR1040-114-A07-6
SFIC 7-pin	CR1050-114-A07-7
SFIC 7-pin less core	CR1040-114-A07-7
Security	CR1010-118-A07
Security IC	CR1090-114-A07
Pyramid (FC) Conventional	CR1020-114-A07
Pyramid (IC)	CR1030-114-A07
Access 3® Patented Fixed Core	CR1500-114-A07
Access 3® Security Fixed Core	CR1600-114-A07
Access 3® High Security Fixed Core	CR1700-114-A07
Access 3® Patented Interchangeable Core	CR1580-114-A07
Access 3® Security Interchangeable Core	CR1680-114-A07
Access 3® High Security Interchangeable Core	CR1788-114-A07

The ASSA ABLOY Group is the global leader in access solutions. Every day, we help billions of people experience a more open world.

ASSA ABLOY Opening Solutions leads the development within door openings and products for access solutions in homes, businesses and institutions. Our offering includes doors, frames, door and window hardware, mechanical and smart locks, access control and service.



For additional information, contact your
ASSA ABLOY Door Security Solutions
sales consultant or visit www.corbinruswin.com.

In U.S.

Corbin Russwin
225 Episcopal Road
Berlin, CT 06037
Phone: 800-543-3658
Fax: 800-447-6714
www.corbinruswin.com

In Canada

ASSA ABLOY Door
Security Solutions Canada
160 Four Valley Drive
Vaughan, Ontario
Canada L4K 4T9
Phone: 800-461-3007
Fax: 800-461-8989
www.assaabloydss.ca