

Corbin
Russwin

ASSA ABLOY

CK4200 Series

Heavy-Duty Cylindrical Knob Locksets



ASSA ABLOY, the global leader
in door opening solutions

Applications

CK4200



Table of Contents

Applications.....	2
Features.....	3
Functions.....	5
Trim Designs.....	7
Options and Accessories.....	9
How to Order.....	11
Quick Codes.....	12
Helpful Terms.....	13
How to Specify.....	14

www.corbinruswin.com

Applications

The highest quality materials and precision manufacturing ensure strength, durability and quiet operation. Ideal for demanding, high-use commercial, industrial and institutional applications, including:

- Schools
- Hotels
- Apartments
- Hospitals and nursing homes
- Churches
- Municipal buildings
- Airports
- Retail complexes
- Offices
- Warehouses

Advantages

- "Lock-on" rose liners and thimble increase security and prevent lock from loosening
- 1-3/4" (44mm) knob shank minimizes wear
- 5/8" (16mm) latch and concealed knob catch enhance strength and security



Features

Handing

Field reversible.

Door Thickness

1-3/4" (44mm) – 2" (51mm) standard.
Optional door thickness available; see Quick Codes, page 12.

Backset

2-3/4" (70mm) standard.
Optional: 3-3/4" (95mm), 5" (127mm) and 7" (178mm); see Quick Codes, page 12.

Lock Chassis

Steel, zinc dichromated for corrosion resistance.
Optional: stainless steel chassis; see Quick Codes, page 12.

Front

Wrought brass, bronze or stainless steel,
2-1/4" (57mm) x 1-1/8" (29mm).
Accommodates doors beveled
1/8" (3mm) to 2" (51mm).
Optional: flat front; see Quick Codes,
page 12.

Latchbolt

Brass, chrome plated, 5/8" (16mm).

Auxiliary Latchbolt

Deadlocking latchbolt prevents
manipulation when door is closed.

Strike

Wrought brass, bronze or stainless steel,
ANSI curved lip standard, 4-7/8" (124mm)
x 1-1/4" (32mm) x 1-1/4" (32mm) lip to
center. Optional strikes, lip lengths and
ANSI wrought strike box available; see
Quick Codes, page 12.

Cylinder

Brass, 6-pin, L4 keyway, 0-bitted standard.

Keying Features Available

Master keying
Construction master keying
Visual key control
Concealed key control
Conventional 6-pin
Interchangeable core (IC)
Security
Security IC
Pyramid Security
Pyramid Security IC
Pyramid High Security
Pyramid High Security IC
Disposable Temporary Core
Master Ring

Keys

Two nickel silver standard.

Warranty

One-year limited.

Certification/Compliance

ANSI

Meets A156.2 Series 4000, Grade 1.

Federal

Meets FF-H-106C.

C-UL US

All locks listed for A Label and lesser class
single doors, 4' x 8'.
Letter F and UL symbol on latch front
indicate listing.

Any retrofit or other field modification to
a fire-rated opening can potentially impact
the fire rating of the opening, and Corbin
Russwin, Inc. makes no representations or
warranties concerning what such impact
may be in any specific situation. When
retrofitting any portion of an existing fire-
rated opening, or specifying and installing
a new fire-rated opening, please consult
with a code specialist or local code official
(Authority Having Jurisdiction) to ensure
compliance with all applicable codes and
ratings.

Features

CK4200

Finishes

BHMA 605	Bright Brass	
BHMA 606	Satin Brass	
BHMA 611	Bright Bronze	
BHMA 612	Satin Bronze	
BHMA 613	Dark Oxidized Satin Bronze, oil rubbed	
BHMA 618	Bright Nickel Plated	
BHMA 619	Satin Nickel Plated	
BHMA 625	Bright Chromium Plated	
BHMA 626	Satin Chromium Plated	
626C	Satin Chromium Plated with MicroShield®	
BHMA 629	Bright Stainless Steel	
BHMA 630	Satin Stainless Steel	
630C	Satin Stainless Steel with MicroShield®	
BHMA 722	Black Oxidized Bronze, oil rubbed	

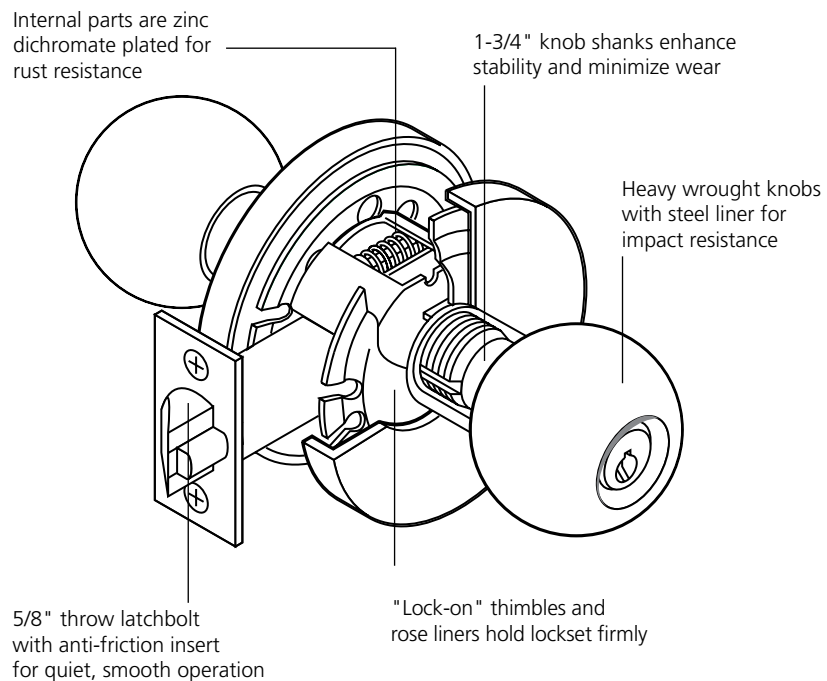

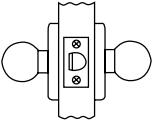
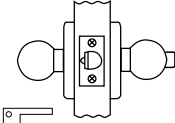
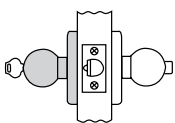
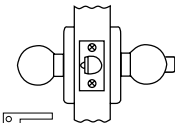
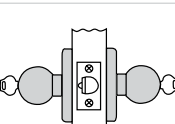
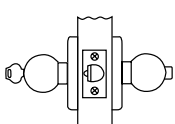
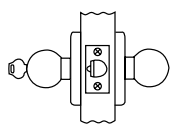
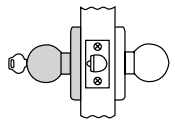
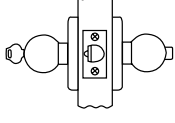
Outside	Inside	Series/Function	Type	ANSI No.	Function Description
		CK4210	Passage or Closet	F75	<ul style="list-style-type: none"> Latchbolt by knob either side. Both knobs always free.
		CK4220	Privacy, Bedroom or Bathroom	F76	<ul style="list-style-type: none"> Latchbolt by knob either side. Outside knob locked by push button. Outside knob unlocked by emergency release tool outside, by rotating inside knob or by closing door. Inside knob always free.
		CK4229	Hotel or Motel	F93	<ul style="list-style-type: none"> Deadlocking latchbolt by knob inside or by key outside. Push button shuts out all keys except emergency key, and projects occupancy indicator in face of cylinder. Push button released by turning inside knob or by closing door.* Outside knob always rigid. Inside knob always free.
		CK4230	Privacy, Bedroom or Bathroom	F76	<ul style="list-style-type: none"> Latchbolt by knob either side. Outside knob locked by push button. Outside knob unlocked by turning slotted button outside, by rotating inside knob, or by closing door. Inside knob always free.
		CK4232	Institution or Utility	F87	<ul style="list-style-type: none"> Deadlocking latchbolt by key either side. Both knobs always rigid
		CK4251	Entrance or Office	F81	<ul style="list-style-type: none"> Deadlocking latchbolt by knob either side, except when turn button locks outside knob. Key outside retracts latchbolt. Outside knob unlocked by turn button. Inside knob always free
		CK4255	Classroom	F84	<ul style="list-style-type: none"> Deadlocking latchbolt by knob either side, except when key outside locks outside knob. Outside knob unlocked by key outside. Inside knob always free.
		CK4257	Storeroom or Closet	F86	<ul style="list-style-type: none"> Deadlocking latchbolt by key in outside knob or by rotating inside knob. Outside knob always rigid. Inside knob always free.
		CK4261	Entrance or Office	F82	<ul style="list-style-type: none"> Deadlocking latchbolt by knob either side, except when push button locks outside knob. Push button released by turning inside knob or by key in outside knob. Closing door does not release push button. Inside knob always free.







*Unless push button has been fixed in locked position by spanner key (furnished). When push button is fixed by spanner key, lock is operable only by emergency key or by display key.

 Indicates optional interchangeable core available; see Quick Codes, page 12.

 Indicates rigid knob.

Functions

CK4200

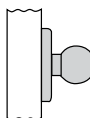
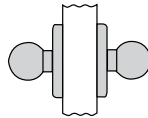
Outside	Inside	Series/Function	Type	ANSI No. Series 4000	Function Description
		CK4272	Apartment Exit or Public Toilet	F88	<ul style="list-style-type: none"> • Deadbolting latchbolt by knob either side, except when key inside locks outside knob. • Key outside retracts latchbolt. • Inside key unlocks outside knob. • Inside knob always free. • Keyed alike unless otherwise specified.
		CK4275	Dormitory	—	<ul style="list-style-type: none"> • Deadlocking latchbolt by knob either side, except when push button or key locks outside knob. • Push button released by turning inside knob, by closing door, by 1/4 counterclockwise turn of key in outside knob, or by key in outside knob. If push button is held in locked position, key in outside knob will retract latchbolt. • Inside knob always free.
		CK4282	Store Door	F91	<ul style="list-style-type: none"> • Deadlocking latchbolt by knob either side, except when key either side locks both knobs. • Keyed alike unless otherwise specified.
		CK4250	Half Dummy Trim	—	<ul style="list-style-type: none"> • Knob acts as pull only; no operation. • Knob is rigid.
		CK4270	Full Dummy Trim	—	<ul style="list-style-type: none"> • Knobs act as pulls only; no operation. • Knobs are rigid.

 Indicates rigid knob.

 Indicates optional interchangeable core available; see Quick Codes, page 12.

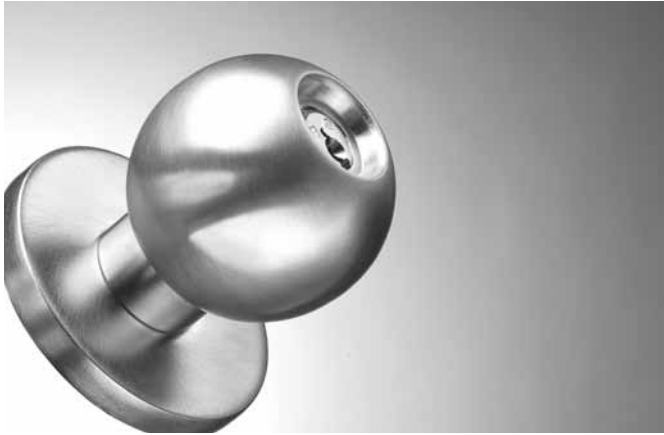

Global

Brass, bronze or stainless steel



GRC

Knob: Wrought reinforced
Rose: Wrought reinforced

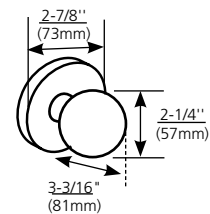

GRD

Knob: Wrought reinforced
Rose: Wrought reinforced

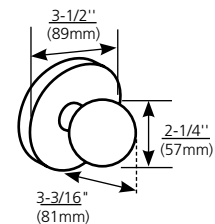

GRE

Knob: Wrought reinforced
Rose: Wrought reinforced

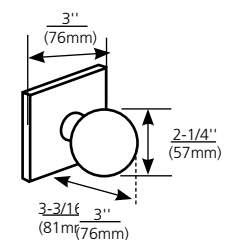

Trim Designs

CK4200



Belmont

Brass, bronze or stainless steel



BRC

Knob: Wrought reinforced

Rose: Wrought reinforced

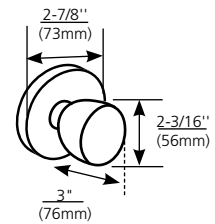

BRD

Knob: Wrought reinforced

Rose: Wrought reinforced

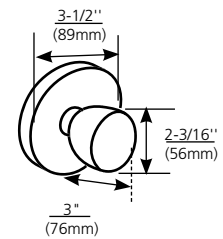

BRE

Knob: Wrought reinforced

Rose: Wrought reinforced

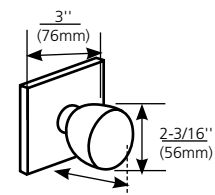

Latches

To order optional latchbolt with lockset, see Quick Codes, page 12.
To order latchbolt separately, specify Part No. x Finish (e.g., 486F83 x 626).

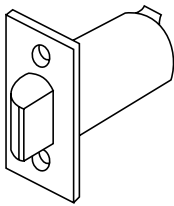

Plain

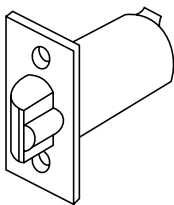

Deadlocking

Description	Plain	Deadbolting
2-3/4" (70mm) Backset Square corner front, 2-1/4" (57mm) x 1-1/8" (29mm) beveled Square corner front, 2-1/4" (57mm) x 1-1/8" (29mm) flat	486F83 486F84	486F89 486F90
3-3/4" (95mm) Backset Square corner front, 2-1/4" (57mm) x 1-1/8" (29mm) beveled Square corner front, 2-1/4" (57mm) x 1-1/8" (29mm) flat	469F27 469F28	469F29 469F30
5" (127mm) Backset Square corner front, 2-1/4" (57mm) x 1-1/8" (29mm) beveled Square corner front, 2-1/4" (57mm) x 1-1/8" (29mm) flat	469F31 469F32	469F33 469F34
7" (178mm) Backset Square corner front, 2-1/4" (57mm) x 1-1/8" (29mm) beveled Square corner front, 2-1/4" (57mm) x 1-1/8" (29mm) flat	469F35 469F36	469F37 469F38

Delrin Insert

Global and Belmont designs available with black Delrin insert at base of knob.
To order with lockset, see Quick Codes, page 12.
To order separately, specify Part No. 493F999

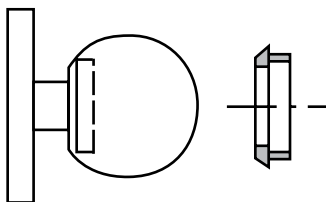

Options and Accessories

CK4200

Strikes

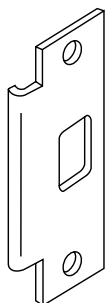

ANSI Curved Lip (standard)
Brass, bronze, or stainless steel
4-7/8" (124mm) x 1-1/4" (32mm) x
1-1/4" (32mm) lip to center
Optional lip lengths: 1" (25mm),
1-1/8" (29mm), 1-3/8" (35mm),
1-1/2" (38mm), 1-3/4" (44mm),
2" (51mm), 2-1/4" (57mm),
2-1/2" (64mm), 2-3/4" (70mm),
3" (76mm)
To order optional strike with lockset, see
Quick Codes, page 12.
To order separately, specify 217L13 x
Lip Length x Finish.

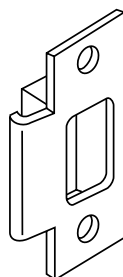

Curved Lip "T" Strike
Brass, bronze, or stainless steel
2-3/4" (70mm) x 1-1/8" (29mm) x
1-1/4" (32mm) lip to center
Optional lip lengths: 1" (25mm),
1-1/8" (29mm), 1-3/8" (35mm),
1-1/2" (38mm), 1-3/4" (44mm),
2" (51mm), 2-1/4" (57mm),
2-1/2" (64mm), 2-3/4" (70mm),
3" (76mm)
To order optional strike with lockset,
see Quick Codes, page 12.
To order separately, specify 586L19 x
Lip Length x Finish.

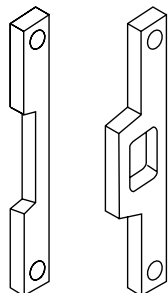

Rabbeted Front and Strike
Brass or bronze
4" (102mm) x 5/8" (16mm) for
1/2" (13mm) rabbet.
No optional lip lengths.
To order with lockset, see Quick Codes,
page 12.
To order separately, specify 601F28 x Finish.

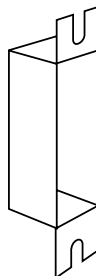

ANSI Wrought Strike Box
To order with lockset, see
Quick Codes, page 12.
To order separately, specify
120F76-8.

Cylinders

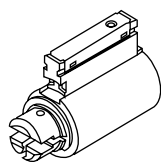

Standard Cylinder
.552" plug diameter
.496" Pyramid plug diameter
Brass, 6 pin,
2 nickel silver keys
Finishes: 606, 626

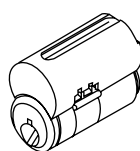

Interchangeable Core
.509" plug diameter conventional
.552" plug diameter security
.496" Pyramid plug diameter
Brass, 6 pin,
2 nickel silver keys
Finishes: 605, 606, 611,
612, 613, 625, 626, 722

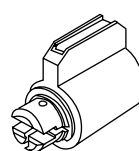

Master Ring Cylinder
.552" plug diameter
Brass, 6 pin,
2 nickel silver keys
Finishes: 606, 626

Conventional	2000-052 (standard)	8000	2060-052
Security	2010-052	8010	N/A
Hotel Conventional	2001-052	8001-042	2061-052
Hotel Security	2011-052	8011-042	N/A
Pyramid High Security	2020-052	8020	N/A
Pyramid Security	2027-052	8027	N/A

To order optional cylinder with lockset, see Quick Codes, page 12.

To order cylinder separately, specify Part No. x Keyway x Finish (e.g., 2000-052 x L4 x 626).

Ordering Examples

Stock Order

Quantity	Series/Function	Trim	Finish	Hand
100	CK4255	GRC	626	RHR

Split Trim/Finish Order

Quantity	Series/ Function	Trim		Finish		Hand
		Outside	Inside	Outside	Inside	
12	CK4255	GRC	BRC	626	625	RHR

Contract / Detailed Order

Quantity	Keyset	Series/ Function	Trim	Finish	Hand	Door Thickness	Backset	Optional Strike	Misc. Options	Optional Cylinder	Keying
24	AA1	CK4255	GRC	626	RHR	D214	B334	SC112	M02-M24	PS	VKC1

Where to find ordering information and quick codes

Series/Function	Pages 5-6
Trim Designs	Pages 7-8
Finish	Page 12
Handing	Page 12
Door Thickness	Page 12
Backset	Page 12
Strike	Page 12
Miscellaneous Option	Page 12
Cylinder and Keying	Page 12

Quick Codes

CK4200

Finish

	Description	Specify
US3	Bright Brass	605
US4	Satin Brass	606
US9	Bright Bronze	611
US10	Satin Bronze	612
US10B	Dark Oxidized Satin Bronze, oil rubbed	613
US14	Bright Nickel Plated	618
US15	Satin Nickel Plated	619
US26	Bright Chromium Plated	625
US26D	Satin Chromium Plated	626
	Satin Chromium Plated with MicroShield®	626C
US32	Bright Stainless Steel	629
US32D	Satin Stainless Steel	630
	Satin Stainless Steel with MicroShield®	630C
	Black Oxidized Bronze, oil rubbed	722

Cylinder and Keying

Description	Specify
Conventional 6-pin	(standard)
Less cylinder(s)	LC
IC 6-pin	C6
IC 6-pin with temporary construction core (Red)	CT6R
IC 6-pin with temporary construction core (Blue)	CT6B
IC 6-pin with temporary construction core (Green)	CT6G
IC 6-pin with temporary construction core	CT6
IC 6-pin less core	CL6
Security ¹	HS
Security IC ¹	CHS
6-pin disposable temporary core	CT6D
Pyramid Security ¹	PS
Pyramid Security IC ¹	PCS
Pyramid High Security ¹	PHS
Pyramid High Security IC ¹	PCHS
Pyramid with temporary construction core	CTP
Pyramid Less Core	CLP
Pyramid disposable temporary construction core	CTPD
Master ring	MR
0-bitted with 2 blank keys	(standard)
Keyed random	KR
Construction master keyed	CMK
Visual key control (VKC)	
- No stamping	VKCO
- Keys only	VKC1
- Cylinders and keys (not for HS or CHS)	VKC2
- Cylinders only (not for HS or CHS)	VKC3
Concealed key control (CKC)	
CKC cylinders with VKC keys	CKC2
CKC cylinders only	CKC3
2 keys per lock	(standard)
More than 2 keys	KY# (e.g., KY6)

NOTE: 1. Not available in CK4229 function.

Strikes

Lip to Center	ANSI Curved Lip Specify	Curved Lip Box Specify
1" (25mm)	SA100	SC100
1-1/8" (29mm)	SA118	SC118
1-1/4" (32mm)	(standard)	SC114
1-3/8" (35mm)	SA138	SC138
1-1/2" (38mm)	SA112	SC112
1-3/4" (44mm)	SA134	SC134
2" (51mm)	SA200	SC200
2-1/4" (57mm)	SA214	SC214
2-1/2" (63mm)	SA212	SC212
2-3/4" (70mm)	SA234	SC234
3" (76mm)	SA300	SC300

Rabbeted front strike Specify SR118

Handing

Description	Specify
Right Hand	RH
Left Hand	LH
Right Hand Reverse	RHR
Left Hand Reverse	LHR

Backset

Description	Specify
2-3/4" (70mm)	(standard)
3-3/4" (95mm)	B334
5" (127mm)	B500
7" (178mm)	B700

Miscellaneous Options

Description	Specify
Delrin insert	M01
Spanner head screws	M02
Torx® head screws	M04
Knob to accept Best-type core	M10
Flat front	M12
ANSI wrought strike box	M17
Knurling outside and inside	M20
Knurling outside only	M21
Knurling inside only	M22
Abrasive coat outside and inside	M23
Abrasive coat inside	M24
Abrasive coat outside	M25
Stainless steel chassis	M26
Lead lined rose (inside only)	M28
Panel application	PNL*

* Must specify door thickness before panel is applied, panel thickness and side of the door panel is applied to (inside or outside).

Door Thickness

Door Thickness	Specify
1-3/4" (44mm) - 2" (51mm)	(standard)
2-1/8" (54mm)	D218
2-1/4" (57mm)	D214
2-3/8" (60mm)	D238
2-1/2" (63mm)	D212
2-5/8" (67mm) - 5" (127mm)*	D258 to D500 in 1/8" increments

* Available only for 10, 20, 51, 55, 57, 61 functions.

Abrasive Coat

Hard granular material applied to a knob or lever to provide a non-slip tactile surface for the visually impaired.

Auxiliary Latchbolt

A supplementary latch which, when the door is closed, automatically deadlocks the latchbolt. Protects the latchbolt from forced retraction or "credit carding."

Backset

The distance from the front of the lock to the centerline of the cylinder or knob/lever hub.

Bevel

The angle of the edge of a door in relation to the inside and outside surfaces of the stile. The most common bevel for commercial doors is 1/8" (3mm) in 2" (51mm).

Box Strike

A strike equipped with an enclosure behind the hole(s) for the latchbolt and/or deadbolt. Protects the strike area from mortar and cement.

Chassis

The housing of a lockset, containing most of the working parts.

Curved Lip Strike

A strike with the lip curved to conform to the detail of the door frame.

Dummy Trim

Trim only, without the lock or latching mechanism, usually used on the inactive door of a pair of doors for design balance.

Front

The part of a lock visible on the edge of a door.

Hand

The direction a door swings.

Knurling

A permanently applied tactile warning engraved in the metal of a knob or lever to warn the visually impaired of dangerous conditions on the other side of the door.

Latchbolt

A lock component having a beveled end that projects from the lock front but may be forced back into the chassis by end pressure or drawn back by action of the retractor. When the door is closed, the latchbolt projects into a hole provided in the strike, holding the door in the closed position.

Lead Lined

Pertains to a lockset whose trim has a lining of lead to prevent the passage of radiation. Generally used in hospital applications.

Lip of Strike

The projection part of a strike which first engages the latch; may be curved or straight.

Non-ferrous

Pertaining to parts which do not contain iron. Ideal for use in corrosive environments.

Rabbet

The portion of a door frame into which the door fits. Also, the abutting edges of a pair of doors, so shaped as to provide an overlap. One half of the edge projects beyond the other half, usually 1/2".

Strike

A metal plate that is pierced or recessed to receive the deadbolt or latchbolt of a lock (sometimes called a keeper).

Throw

The distance that a lock's deadbolt or latchbolt projects when in the locked position. The effective throw is the distance that a latchbolt projects when deadlocked.

Wrought Strike Box

A metal box mounted behind the strike to protect the strike opening from mortar or cement.

Keying and Cylinder Terms

Concealed Key Control (CKC)

The marking of standard key symbols on a cylinder in a location which is not visible once the cylinder is installed.

Construction Core

An interchangeable core for temporary use during construction. It is replaced by the permanent core when construction personnel no longer needs access.

Construction Master Keying (CMK)

A cylinder preparation that allows temporary access by construction personnel.

Control Key

A key used to remove and install interchangeable cores.

Cylinder

A lock component containing the combination that determines which keys will operate.

High Security Cylinder

A cylinder which provides extra resistance to picking and unauthorized duplication of keys.

Interchangeable Core (IC)

A cylinder which can be removed and installed quickly with a control key by non-skilled personnel when rekeying is required.

Key Section

The cross-section of a key blade, as viewed from bow to tip.

Key Symbol

A letter/number combination in standard industry format (e.g. 1AA, AA1, etc.) which indicates exactly how a key or cylinder fits into a keying system.

Keyway

The opening in a cylinder plug through which the key enters.

Master Keying

Preparation of a cylinder to operate with keys of different levels of access.

Master Ring Cylinder

A cylinder which offers a wider range of keying.

Visual Key Control (VKC)

The marking of standard key symbols on keys and on the visible portion of the front of a cylinder.

How to Specify

CK4200

Suggested Specifications

All locksets shall be CK4200 Series Heavy-Duty Cylindrical Knob Locksets as manufactured by Corbin Russwin Architectural Hardware, Berlin, Connecticut.

Locksets shall have a steel chassis, zinc dichromate plated for rust resistance, which fits a 2-1/8" (54mm) door preparation. Latchbolts shall have a 5/8" (16mm) throw and an effective deadlocking throw of 7/16" (11mm). Each latchbolt shall be furnished with a nylon insert for durability and quiet operation.

The standard backset shall be 2-3/4" (70mm), with longer backsets available.

Knobs shall have a minimum thickness of .080" (2mm), and roses a minimum thickness of .035" (0.9mm) with a .065" (1.6mm) liner. Outside knobs shall be removable for rekeying without removing the lockset from the door.

Lock-on thimbles and rose liners shall lock the chassis into the door cutout, preventing lock movement and loosening.

Cylinders shall be 6-pin, constructed of brass, with conventional, high security, interchangeable core and master ring available.

All locksets shall be listed by Underwriters Laboratories for A label and lesser class single doors, 4'x 8'.

Locksets to be used on specified exterior doors or doors subject to special atmospheric conditions (pool areas, chemical laboratories, sewage disposal plants, etc.) shall be constructed of stainless steel.

Certification:

Federal Specification FF-H-106C

ANSI A156.2 Series 4000, Grade 1

All locks, trim and cylinders shall be from one manufacturer.

All locksets shall carry a one-year limited warranty.



ASSA ABLOY

In U.S.

Corbin Russwin
Architectural Hardware
225 Episcopal Road
Berlin, CT 06037
Phone: 800-543-3658
Fax: 800-447-6714
corbinrusswin.com

In Canada

ASSA ABLOY Door
Security Solutions Canada
160 Four Valley Drive
Vaughan, Ontario
Canada L4K 4T9
Phone: 800-461-3007
Fax: 905-738-2478
www.assaabloy.ca

For more information regarding Corbin Russwin Locksets, Exit Devices, Door Controls and Key Systems, contact your authorized Corbin Russwin Distributor or Sales Representative.



MicroShield®

As part of their promise to provide innovative solutions to their customers, certain ASSA ABLOY Group brands offer the MicroShield® technology, a silver-based antimicrobial coating designed to inhibit the growth of bacteria. MicroShield® is a registered trademark of Yale Security Inc., an ASSA ABLOY Group company.

Corbin Russwin and Design® is a registered trademark of Corbin Russwin, Inc., an ASSA ABLOY Group company. Other products' brand names may be trademarks or registered trademarks of their respective owners and are mentioned for reference purposes only. These materials are protected under US copyright laws. All contents current at time of publication. Corbin Russwin, Inc., an ASSA ABLOY Group Company, reserves the right to change availability of any item in this catalog, its design, construction, and/or its materials. Copyright © 2003, 2011 Corbin Russwin, Inc., an ASSA ABLOY Group company. All rights reserved. Reproduction in whole or in part without the express written permission of Corbin Russwin, Inc. is prohibited.

ASSA ABLOY is the global leader in door opening solutions, dedicated to satisfying end-user needs for security, safety and convenience.