



ASSA ABLOY

CK4700 Series

Light/Medium Duty Knob Locksets



ASSA ABLOY, the global leader
in door opening solutions

Introduction

CK4700



Quality

The CK4700 series is a Grade 2 light/medium-duty knob lockset which provides an outstanding combination of value and performance. It is the ideal knob lockset for light commercial and heavy-duty residential applications such as interior offices, closets, multi-family housing, restaurants and retail complexes. The CK4700 series provides quality materials and performance.

Vandal Resistance

CK4700 series locksets are available with Corbin Russwin's Pyramid patented* security cylinder, the most secure locking system available. Pyramid is especially recommended for installations that require superior protection against picking and drilling. See the Key Systems catalog for additional information. (* Patent No. 6, 125, 674)

Key Advantages

- ANSI Grade 2 certification
- UL 1-1/2 hour fire rating
- Pyramid cylinders for increased security
- Interlocking tubular chassis and latchbolt

Table of Contents

Introduction.....	2
Features.....	3
Functions.....	4
Trim Design.....	5
Options and Accessories.....	6
How to Order.....	8
Quick Codes.....	9
Specifications.....	10



Features

Handing

Non-handed.

Door Thickness

1-3/8" (35mm) to 1-3/4" (44mm).

Lock Chassis

Die cast zinc for corrosion resistance.

Backset

2-3/4" (70mm) standard.

Optional: 2-3/8" (60mm). See Quick Codes, page 9.

Latches

1/2" (13mm) bolt projection.

Auxiliary Latchbolt

Deadlocking latchbolt prevents manipulation when door is closed.

Strike

T- Strike standard. Optional strikes, lip lengths and ANSI wrought strike box available; see Quick Codes, page 9.

Cylinder

Brass, 6-pin, L4 keyway, 0-bitted standard.

Keying Features Available

Master keying
Construction master keying
Visual key control
Concealed key control
High Security Pyramid

Keys

Two nickel silver standard.

Warranty

One-year limited.

Certification/Compliance

ANSI

Meets A156.2 Series 4000, Grade 2.

UL/ULC

All locks listed for B Label Single doors.
UL symbol on latch front indicates listing.

Any retrofit or other field modification to a fire-rated opening can potentially impact the fire rating of the opening, and Corbin Russwin, Inc. makes no representations or warranties concerning what such impact may be in any specific situation. When retrofitting any portion of an existing fire rated opening, or specifying and installing a new fire-rated opening, please consult with a code specialist or local code official (Authority Having Jurisdiction) to ensure compliance with all applicable codes and ratings.

Finishes

BHMA 605	Bright Brass
BHMA 626	Satin Chromium Plated

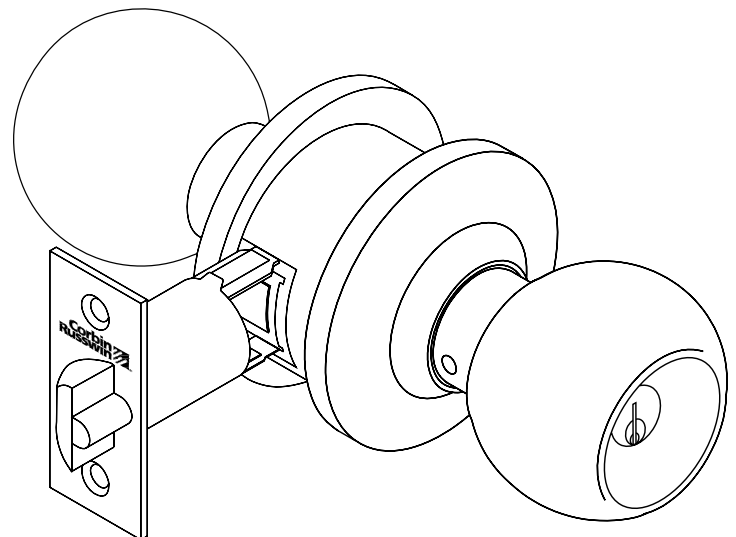

Functions

CK4700

Outside	Inside	Series/Function	Type	ANSI No.	Function Description
		CK4710	Passage or Closet	F75	<ul style="list-style-type: none"> • Deadlocking latchbolt by knob either side. • Both knobs always free.
		CK4720	Privacy Bedroom or Bathroom	F76	<ul style="list-style-type: none"> • Deadlocking latchbolt by knob either side. • Outside knob locked by button. • Outside knob unlocked by button inside, or by rotating inside knob. • Emergency release in outside knob. • Inside knob always free.
		CK4751	Entrance or Office	F81	<ul style="list-style-type: none"> • Deadlocking latchbolt by knob either side, except when button locks outside knob. • Rotating button locks outside knob, requiring key to unlock. Turning inside knob unlocks outside knob. • Rotating button the other way locks outside knob, requiring key to unlock. Turning inside knob unlocks outside knob only when button is rotated back to unlock. • Inside knob always free.
		CK4755	Classroom	F84	<ul style="list-style-type: none"> • Deadlocking latchbolt by knob either side, except when key outside locks outside knob. • Outside knob unlocked by key outside. • Inside knob always free.
		CK4759	Storeroom or Public Restroom	F86	<ul style="list-style-type: none"> • Deadlocking latchbolt by knob inside. • Key outside unlocks outside knob to retract latchbolt. • Knob retracts latchbolt. • Key is retained in the unlocked mode. • When key is removed, outside knob is locked. • Inside knob always free.
		CK4750	Half Dummy Trim (Surface Mounted)	—	<ul style="list-style-type: none"> • Knob acts as pull only; no operation. • Knob is rigid.

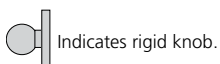

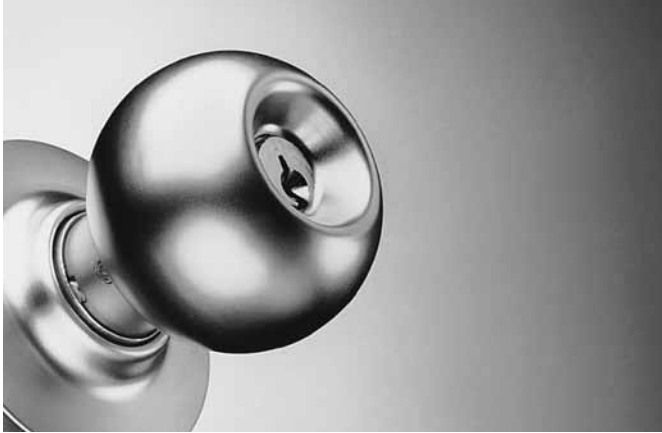

Global

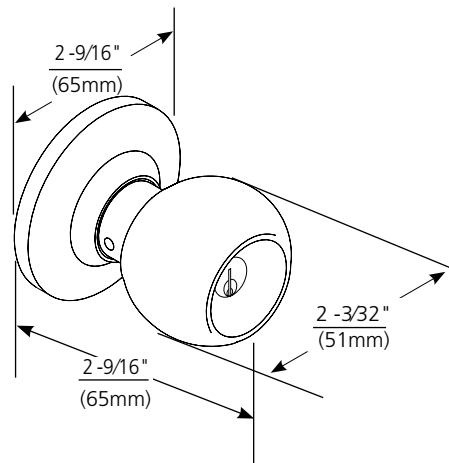

GWC

Knob: Brass

Knob projection: 2-9/16" (65mm)

Rose: Brass

Rose diameter: 2-9/16" (65mm)

Options and Accessories

CK4700

Latches

To order optional latchbolt with lockset, see Quick Codes, page 9.
To order latchbolt separately, specify Part No. x Finish
(e.g., 687F63 x 626).

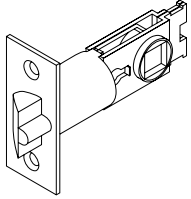

Backset and Front Description			UL Latches
2-3/4" (70mm)	Square Corner Front	2-1/4" (57mm) x 1-1/8" (29mm) faceplate	687F63
2-3/8" (60mm)	Square Corner Front	2-1/4" (57mm) x 1" (25mm) faceplate	687F64
2-3/8" (60mm)	1/4" (6mm) Round Corner Front	2-1/4" (57mm) x 1" (25mm) faceplate	687F65
1" (25mm) Latch Sleeve			687F71

All CK4700 Latches are Deadlocking.

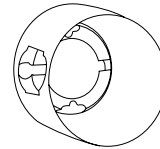
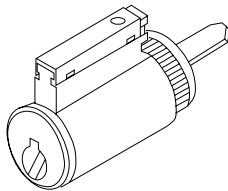

Cylinders

		Standard Cylinder .509" plug diameter conventional .496" plug diameter high security Brass, 6-pin 2 nickel silver keys Finishes: 606, 626
Conventional	6-Pin	(standard) (2000-037)
Pyramid High Security	7-pin	(2020-037)
Pyramid Security	7-pin	(2027-037)
Schlage® C Keyway	5-Pin	2400-037-C-5 "O" bitted or keyed random

To order optional cylinder with lockset, see Quick Codes, page 9.
To order cylinder separately, specify Part No. x Keyway x Finish
(e.g., 2000-037 x L4 x 626).

UL Firecup

Part No. 687F66

Supplied standard with all CK4700's. Failure to use invalidates UL listing.

Screw Pack

Part No. 687F96

Supplied standard with wood-machine screws combination.

Strikes

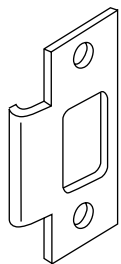

Curved Lip "T" Strike

2-3/4" (70mm) x 1-1/8" (29mm) x
1-1/4" (32mm) lip to center
Supplied standard with lockset.
To order separately, specify 586L19 x Lip
Length x Finish.

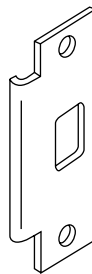

ANSI Curved Lip

4-7/8" (124mm) x 1-1/4" (32mm) x
1-1/4" (32mm) lip to center
To order with lockset, specify SA114.
To order separately, specify 217L13 x Lip
Length x Finish.

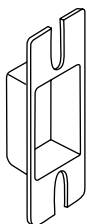

Dust Box for 2-3/4" (70mm) Curved Lip "T" Strike

To order with lockset, specify M77.
To order separately, specify 687F94 x
Finish.

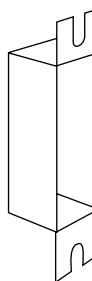

ANSI Wrought Strike Box

To order with lockset, specify M17.
To order separately, specify 120F76-8.

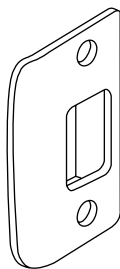

Full Lip Radius Corner

2-1/4" (57mm) x 1-1/2" (38mm) x
1" (25mm) lip to center
To order with lockset, specify SFR114.
To order separately, specify 687F62 x
1-1/8" (29mm) x Finish.

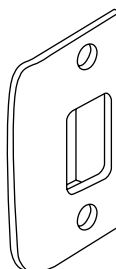

Full Lip Square Corner

2-1/4" (57mm) x 1-1/2" (38mm) x 1" (25mm)
lip to center
To order with lockset, specify SF114.
To order separately, specify 687F61 x Finish.

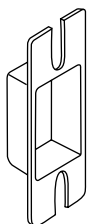

Dust Box for 2-1/4" (57mm) Full Lip Radius and Square Corner Strikes

To order with lockset, specify M78.
To order separately, specify 687F95 x Finish.

How to Order

CK4700

Ordering Examples

Stock Order

Quantity	Series/Function	Trim	Finish
100	CK4755	GWC	626

Where to find ordering information and quick codes

Handing	Page 3
Series/Function	Page 4
Trim Design	Page 5
Finish	Page 9
Door Thickness	Page 9
Backset	Page 9
Strike	Page 9
Miscellaneous Options	Page 9
Cylinders and Keying	Page 9

Contract/Detailed Order

Quantity	Keyset	Series/Function	Trim	Finish	Backset	Misc. Options	Keying
24	AA1	CK4755	GWC	626	B238	M17	CKC2

Finishes

Description		Specify
BHMA 605 (US3)	Bright Brass	605
BHMA 626 (US26D)	Satin Chromium Plated	626

Backset

Description	Specify
2-3/8" (60mm)	B238
2-3/4" (70mm)	(standard)

Cylinder and Keying

Description	Specify
Conventional 6-pin	(standard)
Less cylinder	LC
0-bitted with 2 blank keys	(standard)
Keyed random	KR
Construction master keying (not available for Pyramid)	CMK
Pyramid High Security	PHS
Pyramid Security	PS
Visual Key Control (VKC)	
- No keying data stamped on key or cylinder	VKC0
- Keys only	VKC1
- Cylinders and keys (not for PHS)	VKC2
- Cylinders only (not for PHS)	VKC3
Concealed key control (CKC)	
- CKC cylinders with VKC keys	CKC2
- CKC cylinders only (not for PHS)	CKC3
2 keys per lock	(standard)
More than 2 keys	KY# (e.g., KY6)

Door Thickness

Description	Specify
1-3/8" (35mm) - 1-3/4" (44mm)	(standard)

Strike

Strike Type	Specify
ANSI Curved Lip	SA114
Curved Lip "T" Strike	(standard)
Full Lip 1/4" (6mm) Radius Corner	SFR114
Full Lip Square Corner	SF114

Miscellaneous

Description	Specify
Less cylinder with tailpiece for Schlage® cylinder	M06
1-1/8" (29mm) latch front, square corners (standard with 2-3/4" (70mm) backset).	(standard)
1" (25mm) latch front, square corners (standard with 2-3/8" (60mm) backset). Available in 2-3/8" (60mm) backset only.	M14
1" (25mm) latch front, rounded corners. Available in 2-3/8" (60mm) backset only.	M15
Dust box for 2-3/4" (70mm) strike	M77
Dust box for 2-1/4" (57mm) strike	M78
ANSI wrought strike box	M17

Specifications

CK4700

Locksets shall be CK4700 Series Grade 2 Key-in-Knob Locksets.

Locks shall have an interlocking tubular chassis and latchbolt.

Locksets shall be adjustable for 1-3/8" (35mm) and 1-3/4" (44mm) door thickness. The latchbolt shall be adjustable to accommodate flat or beveled doors, shall have a 1/2" (13mm) throw and shall include a deadlocking feature to inhibit manipulation when door is closed.

Inside and outside knobs shall be of the same profile and projection for aesthetic continuity. The knob shall have a 2-9/16" (65mm) projection from face of door.

Locksets shall be furnished with two nickel silver keys. All cylinder plugs shall furnished with 6-pin chambers for master keying capabilities.

Cylinders shall be easily changed by removing the knob without disassembling the lockset.

Certification:

UL 1-1/2 Hour Fire Rating

ANSI A156.2 Series 4000, Grade 2

Locksets shall carry a one-year warranty.



ASSA ABLOY

In U.S.

Corbin Russwin
Architectural Hardware
225 Episcopal Road
Berlin, CT 06037
Phone: 800-543-3658
Fax: 800-447-6714
corbinrusswin.com

In Canada

ASSA ABLOY Door
Security Solutions Canada
160 Four Valley Drive
Vaughan, Ontario
Canada L4K 4T9
Phone: 800-461-3007
Fax: 905-738-2478
www.assaabloy.ca

For more information regarding Corbin Russwin Locksets, Exit Devices, Door Controls and Key Systems, contact your authorized Corbin Russwin Distributor or Sales Representative.

Corbin Russwin and Design® is a registered trademark of Corbin Russwin, Inc., an ASSA ABLOY Group company. Other products' brand names may be trademarks or registered trademarks of their respective owners and are mentioned for reference purposes only. These materials are protected under US copyright laws. All contents current at time of publication. Corbin Russwin, Inc., an ASSA ABLOY Group Company, reserves the right to change availability of any item in this catalog, its design, construction, and/or its materials. Copyright © 2001, 2013 Corbin Russwin, Inc., an ASSA ABLOY Group company. All rights reserved. Reproduction in whole or in part without the express written permission of Corbin Russwin, Inc. is prohibited.

ASSA ABLOY is the global leader in door opening solutions, dedicated to satisfying end-user needs for security, safety and convenience.