

ED2000 Series

Exit Device

Product Catalog

Experience a safer
and more open world

Introduction

ED2000 Series

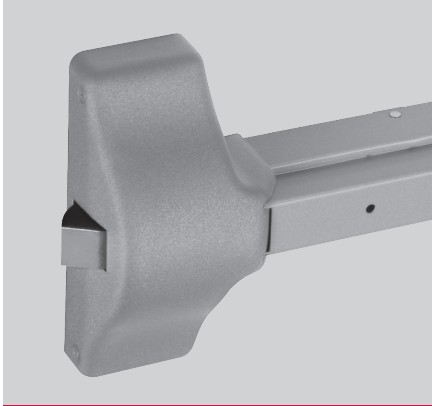

ED2000 Series Exit Device

Corbin Russwin ED2000 Series exit device is the ideal choice for economy commercial applications where you need consistent quality, dependability and ease of use and installation. The ED2000 Series is ANSI/BHMA certified Grade 1, with durable construction and versatile mounting applications, making it ideal for a variety of facilities.

Advantages

- ANSI/BHMA Grade 1 certified 
- Easy-to-use touchbar for quick egress and ADA compliance
- Heavy-duty steel construction
- Low profile and projection for barrier-free code compliance
- No projecting parts to inhibit egress
- Accommodates various trim functions for flexibility
- Wide range of trim styles and finishes to match other Corbin Russwin products
- Devices available to satisfy C-UL US safety and fire requirements
- One-year warranty

Table of Contents

Introduction.....	2
Applications and Listings.....	3
Rim Exit Features.....	4
Surface Vertical Rod Exit Features	6
Rim/Vertical Rod Trims and Functions	8
Options & Accessories.....	11
Cylinders.....	12
Mullions.....	13
How to Order	14
Quick Codes	15
How to Specify	17

Applications and Listings

ED2000 Series

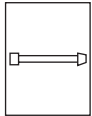
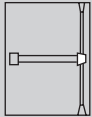
Single Door	Listing	Maximum Opening	Application
Rim ED2200 ED2200A	Panic 3Hr. UL	4' x * 4' x 8'	Surface applied; single point latching. 
Surface Vertical Rod ED2400	Panic	4' x 8'	Surface applied; two point latching. 

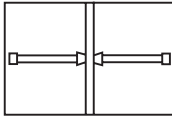
Pair of Doors with Removable Mullion	Listing	Maximum Opening	Application
Rim x Rim ED2200 x ED2200 x CR910 ED2200A x ED2200A x CR910A	Panic 3Hr. UL	8' x 10' 8' x 8'	2 independent active doors with removable mullion. 

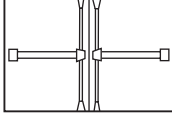
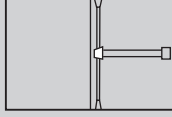
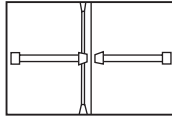
Pair of Doors	Listing	Maximum Opening	Application
Surface Vertical Rod x Surface Vertical Rod ED2400 x ED2400 ED2400A x ED2400A	Panic 1-1/2 Hr. UL	8' x 8' 8' x 8'	2 independent doors with 2 point latching, swinging in the same direction. Overlapping astragal may not be required. 
Surface Vertical Rod x Surface Vertical Rod (Double Egress) ED2400 x ED2400 ED2400A x ED2400A	Panic 3 Hr. UL	8' x 8' 8' x 8'	2 independent doors with 2 point latching, swinging in opposite directions. Overlapping astragal required for 3-hour openings. 
Surface Vertical Rod x Rim ED2400 x ED2200 x S02	Panic	8' x 8'	S02 strike required on inactive door; coordinator recommended. 

Note: All ED2000 Series touchbar exit devices are UL305 panic listed.
*UL does not set a door height limitation on panic applications.

Rim Exit Features

ED2000 Series

ED2200 Series Panic Listed Rim Exit Device ED2200A Series 3-Hour Fire Listed Rim Exit Device



Features

Handing

Non-handed for easy installation

Bar Length

Easily field cut to size.

Standard: 36" (914mm) bar fits 30" - 36" (762mm-914mm) door.

Optional: 24" (610mm) bar fits 24" (610mm) door; specify W024.

Optional: 48" (1219mm) bar fits 36" - 48" (914mm-1219mm) door; specify W048.

Latchbolt

Full 3/4" (19mm) projection, 1" (25mm) wide.

Door Opening Length

-36 for 30" - 36" (76cm - 91cm) doors

-42 for 36" - 42" (91cm - 107cm) doors

-48 for 42" - 48" (107cm - 122cm) doors

Door Thickness

1-3/4" (44mm) standard. Refer to page 18 for other door thicknesses

Minimum Stile Width

4-1/2" (114mm)

Projection

Minimum width 5" (127mm).

Projection

2-1/2" (64mm) active, 1-3/4" (44mm) depressed

Strike

Surface-mounted 3/8" (10mm) diameter roller strike, complete with positive locking plate and shims, assuring low friction relocking for a long, trouble-free life.

Cylinders

Cylinder not included unless specified. See Quick Codes, page 15.

Removable Mullion

See Mullions, page 13.

Trim

1800ET series utility trim, CR500 series rose trim

Dogging

Hex key dogging supplied standard on panic devices

Options

Optional for mounting device over raised vision light molding; specify M58.

Warranty

One-year limited.

Certification/Compliance

ANSI/BHMA Certified

A156.3 Type 1, Grade 1 

UL/cUL Listed

FVSR/FVSR7 - Panic hardware

GXHX/GXHX7 - Fire exit hardware (F)

(up to 4' x 8' single, 8' x 8' pairs, 3 hr.)

All devices listed for safety as panic hardware; devices comply with UL 305 standards for panic hardware. UL symbol on rear cover label indicates listing. Threehour fire-rated devices listed as fire exit hardware for A label and lesser class 4' x 8' single or 8' x 8' double doors; UL symbol on rear cover label indicates listing. Any retrofit or other field modification to a fire rated opening can potentially impact the fire rating of the opening, and Corbin Russwin, Inc. makes no representations or warranties concerning what such impact may be in any specific situation. When retrofitting any portion of an existing fire rated opening, or specifying and installing a new fire-rated opening, please consult with a code specialist or local code official (Authority Having Jurisdiction) to ensure compliance with all applicable codes and ratings.

California State Reference Code

This product has been approved by the California State Fire Marshal pursuant to section 13144.1 of the California Health and Safety Code.

NFPA

All exit devices comply with NFPA 101 Life Safety Code. All fire-rated devices comply with NFPA 80 Fire Doors and Windows.

ADA

Exit devices, lever trims and pulls comply with Americans with Disabilities Act.

Finishes

BHMA 689	Silver Aluminum Painted
BHMA 691	Light Bronze Painted
BHMA 693	Black Painted
BHMA 695	Dark Bronze Painted
BHMA 626	Satin Chromium Plated (Trim Only)
BHMA 630	Satin Stainless Steel (Trim Only)
BSP	Black Suede Powder Coat
WSP	White Suede Powder Coat (Device Only)

Rim Exit Features

ED2000 Series

ED2200 and ED2200A Rim Exit Devices

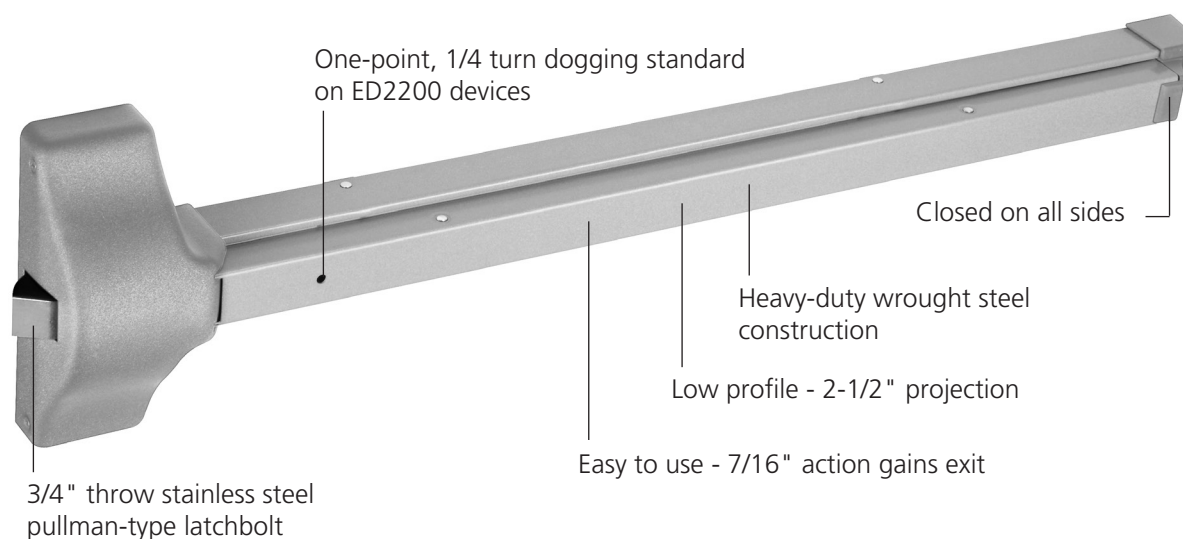

Surface Vertical Rod Features

ED2000 Series

ED2400 Series Panic Listed Surface Vertical Rod Exit Device ED2400A Series 3-Hour Fire Listed Surface Vertical Rod Exit Device

Features

Handing

Handed, specify hand (field reversible)

Bar Length

Easily field cut to size.

Standard: 36" (914mm) bar fits 30" - 36" (762mm-914mm) door.

Optional: 24" (610mm) bar fits 24" (610mm) door; specify W024.

Optional: 48" (1219mm) bar fits 36" -48" (914mm-1219mm) door; specify W048.

Latchbolt

Top: 3/4" (19mm) throw, stainless steel pullman-type with automatic deadlatching.

Bottom: 5/8" (16mm) throw deadbolt, held retracted during door swing.

Door Opening Length

-36 for 30" - 36" (76cm - 91cm) doors

-42 for 36" - 42" (91cm - 107cm) doors

-48 for 42" - 48" (107cm - 122cm) doors

Door Opening Height

Standard door height 7' (213cm), with the device centerline at 39-15/16" (101cm) from floor

Optional heights up to 8' (244cm) by using rod extensions

Door Thickness

1-3/4" (44mm) standard. Refer to page 18 for other door thicknesses

Minimum Stile Width

4-1/2" (114mm)

Projection

Minimum width 5" (127mm).

Projection

2-1/2" (64mm) active, 1-3/4" (44mm) depressed

Strike

Top: adjustable strike with positive locking plate and shims.

Bottom: flush mounted.

Optional strikes available; see Options and Accessories, page 51

Cylinders

Cylinder not included unless specified. See Quick Codes, page 15.

Removable Mullion

See Mullions, page 13.

Trim

1800ET series utility trim, CR500 series rose trim

Dogging

Hex key dogging supplied standard on panic devices

Options

Shim Kit M58, Sex Nuts and Bolts, Bottom Pullman Latch (panic only)

Warranty

One-year limited.

Certification/Compliance

ANSI/BHMA Certified

A156.3 Type 1, Grade 1 

UL/cUL Listed

FVSR/FVSR7 - Panic hardware

GXHX/GXHX7 - Fire exit hardware (F)

(up to 4' x 8' single, 8' x 8' pairs, 3 hr.)

All devices listed for safety as panic hardware; devices comply with UL 305 standards for panic hardware. UL symbol on rear cover label indicates listing

Three hour fire-rated devices listed as fire exit hardware for A label and lesser class 4' x 8' single or 8' x 8' double doors; UL symbol on rear cover label indicates listing.

Any retrofit or other field modification to a fire rated opening can potentially impact the fire rating of the opening, and Corbin Russwin, Inc. makes no representations or warranties concerning what such impact may be in any specific situation. When retrofitting any portion of an existing fire rated opening, or specifying and installing a new fire-rated opening, please consult with a code specialist or local code official (Authority Having Jurisdiction) to ensure compliance with all applicable codes and ratings.

California State Reference Code

This product has been approved by the California State Fire Marshal pursuant to section 13144.1 of the California Health and Safety Code.

NFPA

All exit devices comply with NFPA 101 Life Safety Code. All fire-rated devices comply with NFPA 80 Fire Doors and Windows.

ADA

Exit devices, lever trims and pulls comply with Americans with Disabilities Act.

Finishes

BHMA 689	Silver Aluminum Painted
BHMA 691	Light Bronze Painted
BHMA 693	Black Painted
BHMA 695	Dark Bronze Painted
BHMA 626	Satin Chromium Plated (Trim only)
BHMA 630	Satin Stainless Steel (Trim only)
BSP	Black Suede Powder Coat
WSP	White Suede Powder Coat

Surface Vertical Rod Features





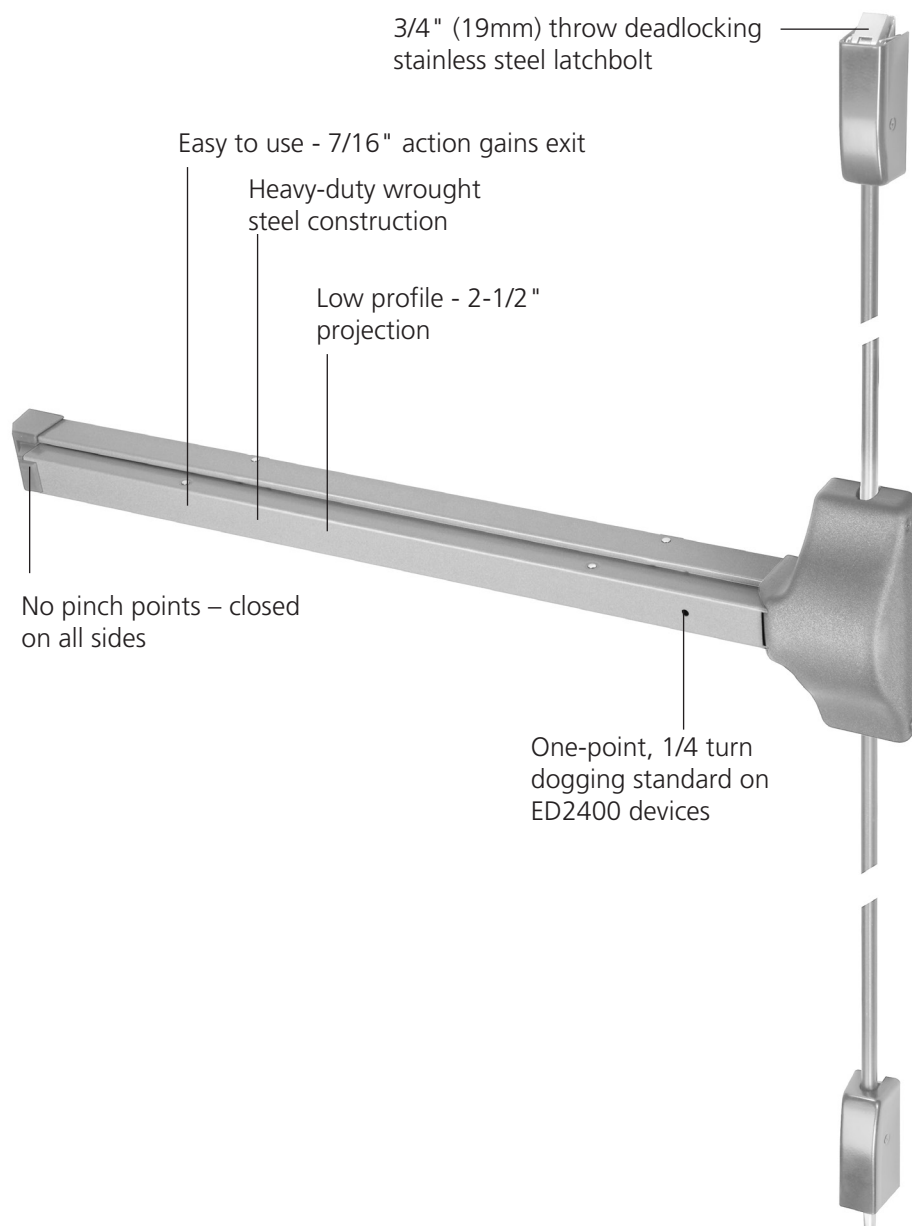





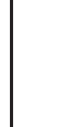





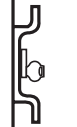

ED2000 Series

ED2400 and ED2400A Surface Vertical Rod Exit Devices

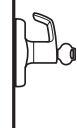

Functions

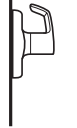
ED2000 Series

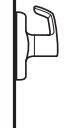
Rim ED2200 ED2200A		Surface Vertical Rod ED2400 ED2400A		Type	ANSI No.	Function Descriptions
Inside	Outside	Inside	Outside			
				Exit Only	F01	<ul style="list-style-type: none"> Exit only; no trim.
				Dummy	F02	<ul style="list-style-type: none"> Entrance by trim when actuating bar is locked down.
				Nightlatch	F03	<ul style="list-style-type: none"> Entrance by trim when latch bolt is retracted by key. Key removable only when locked.
				Classroom	F08	<ul style="list-style-type: none"> Entrance by knob or lever. Key locks or unlocks knob or lever.
				Passage	—	<ul style="list-style-type: none"> Latch bolt retracted by knob or lever.







Indicates rigid grip when locked.

Note: Trims shown are for function representation only. See pages 9 and 10 for available trims.

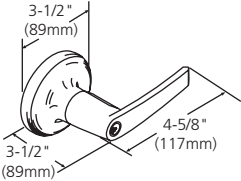
Functions

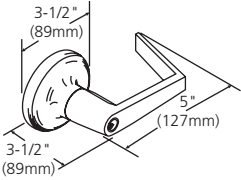
ED2000 Series

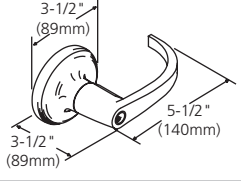
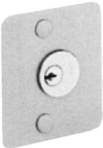
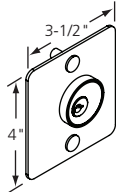



Trim Design		Trim/Function				
		Passage	Dummy ANSI No. F02	Classroom ANSI No. F08	Nightlatch ANSI No. F03	
	<p>Armstrong A5 Lever: Die cast zinc Rose: Wrought brass or bronze Cylinder: Key-in-lever</p>		A510ET	A550ET	A555ET	A557ET ²
	<p>Newport N5 Lever: Die cast zinc Rose: Wrought brass or bronze Cylinder: Key-in-lever</p>		N510ET	N550ET	N555ET	N557ET ²
	<p>Princeton PR5 Lever: Die cast zinc Rose: Wrought brass or bronze Cylinder: Key-in-lever</p>		PR510ET	PR550ET	PR555ET	PR557ET ²
	<p>Flat Plate F18 Plate: Steel Cylinder: Rim Available in plated and painted finishes.</p>		N/A	N/A	N/A	F1857ET

Notes:

- Blank plate with no ANSI function.
- Not recommended for use with ED2400 or ED2400A Surface Vertical Rod devices.

Functions

ED2000 Series

Trim Design			Trim/Function			
			Passage	Dummy ANSI No. F02	Classroom ANSI No. F08	Nightlatch ANSI No. F03
	Leaf Pull P18 Pull: Extruded Cylinder: Rim Available in painted finishes only.		N/A	P1850ET	N/A	P1857ET ²
	Key Only K1 Cylinder: Rim Note: Available with cylinder option only. Ex: K057 x 6P		N/A	N/A	N/A	K157ET

2. Not recommended for use with ED2400 or ED2400A Surface Vertical Rod devices.

Options and Accessories

ED2000 Series

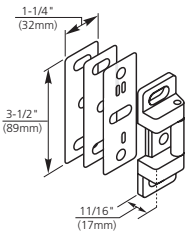
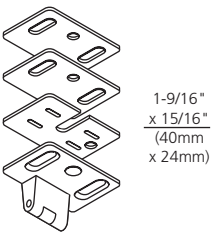
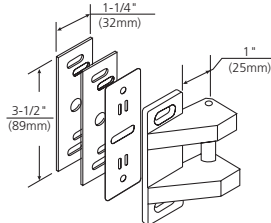
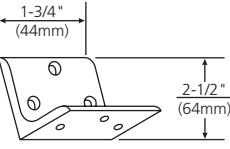
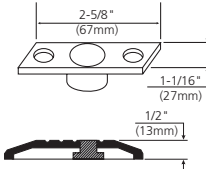
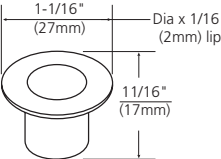
Rim Strikes (Screws Included)	Vertical Rod Strikes (Screws Included)
 <p>Rim Strike Standard on ED2200 and ED2200B devices. To order separately, specify 650F308.</p>	 <p>Top Strike Standard on ED2400(A) devices. To order separately, specify 650F548.</p>
 <p>Rim x Vertical Rod Strike Required for ED2200 devices when used on pair of doors with ED2400 device. To order with exit device, specify S02. To order separately, specify 655F718.</p>	 <p>Flush Transom Top Strike Bracket Optional for use with ED2400 and ED2400A devices. Used to mount top strike on openings with flush transom. 2-1/2" x 1-5/8" (64mm x 41mm). Black finish only. To order, specify 650F878.</p>
 <p>Flush Bottom Strike Optional for ED2400 devices only. To order with exit device, specify S09. To order separately, specify 650F888.</p>	 <p>Fire-Rated Bottom Strike Standard on ED2400(A) devices. To order separately, specify 650F578.</p>

Shim Kits

Shim kits are available for devices on doors with interfacing molding.

Each shim kit contains:

- 2 sets of 1/8" shims (shim up to 1/4")
- Longer connecting bar for the trim
- Installation instructions

867F498 – Shim Kit for ED2200(A) Series rim exit devices



867F508 – Shim Kit for ED2400(A) Series surface vertical rod exit devices

Cylinders

ED2000 Series

Cylinders

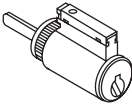
L4 keyway standard. To order with Exit Device, see Quick Codes, page 15. To order separately, specify Part No. x keyway x Finish (e.g., CR2000-039 x L4 x 626).

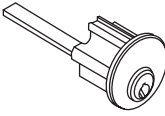
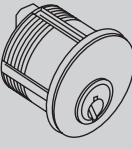
	Cylinder Type	Part No.	Description
Key-in-Lever for A5, N5 & PR5 trim		CR2000-039 CR2010-039	6-pin 6-pin, Security
Interchangeable Core Optional for A5, N5 & PR5 trim		CR8000 CR8010 CR8200	6-pin 6-pin, Security 6-pin, SFIC
Rim for all other trim		CR3000-200 CR3000-200-7 CR3010-200 CR3080-178 CR3080-178-7 CR3070-178 CR3070-178-7 CR3090-178 CR3020-200 CR3027-200 CR3030-178 CR3037-178 CR3050-178 CR3050-178-7 CR3040-178 CR3040-178-7	6-pin 7-pin, horizontal tailpiece 6-pin, horizontal tailpiece, Security 6-pin, LFIC 7-pin, LFIC 6-pin, LFIC less core 7-pin, LFIC less core 6-pin, Security LFIC Pyramid High Security Pyramid Security 7-pin Pyramid, LFIC High Security Pyramid Security LFIC 6-pin, SFIC 7-pin, SFIC 6-pin, SFIC, Less Core 7-pin, SFIC, Less Core
CR900 Series Key Removable Mullion Mortise Cylinders		CR1000-118-A62 CR1000-114-A62-7 CR1080-114-A62 CR1080-112-A62-7 CR1070-114-A62 CR1070-112-A62-7 CR1020-114-A62 CR1027-114-A62 CR1030-114-A62 CR1037-114-A62 CR1010-118-A62 CR1090-114-A62 CR1050-114-A62 CR1050-114-A62-7 CR1040-114-A62 CR1040-114-A62-7	6-Pin 7-Pin 6-Pin, LFIC 7-Pin, LFIC 6-pin, LFIC, less core 7-pin, LFIC, less core 7-pin, Pyramid High Security 7-pin, Pyramid Security 7-pin, Pyramid High Security LFIC 7-pin, Pyramid Security LFIC Security Security LFIC 6-pin, SFIC 7-pin, SFIC 6-pin, SFIC, Less Core 7-pin, SFIC, Less Core

CR900 Series Key Removable Mullion Cylinder Collar Packet

Mullion Series	Cylinder Length and Type			
	1-1/8"	1-1/4"	1-1/4" IC	1-1/2" IC
CR972BKM CR910BKM	610F01*	447F43*		609F37*

Note: Cylinder collar packets contain a collar and spring washer.

*Specify finish when ordering packets.

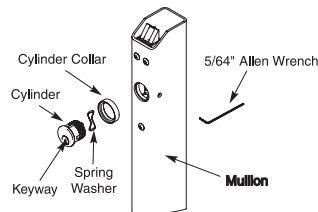

Cylinders/Mullions

ED2000 Series

Compatibility with Competitive Cylinders

Competitive Cylinder	Complete Trim	Tailpiece for Optional Cylinders
Schlage® conventional 21-002, 23-001 or 23-013	Specify M06	682F39-8 Tailpiece
Schlage Primus 20-548, 20-550, 20-748 or 20-750	Specify M06	682F39-8 Tailpiece
Best® style core, 6 or 7-pin	Specify M08	682F958 Tailpiece
Schlage IC Core	Specify M69	697F94-2 Tailpiece
IC 6-Pin	Specify C6	682F918 Tailpiece kit
IC 7-Pin	Specify C7	682F918 Tailpiece kit

For Assa and Medeco retrofit cylinders, consult those manufacturers' catalogs.

CR900 Series Removable Mullions

The CR900 series mullions are used to install two ED2200 Rim Exit Devices in a double door opening. They may be quickly and easily removed, then reinstalled, when a full double door opening is temporarily required. The CR900 series mullions meet ANSI A156.3, Type 22.

Materials and Finish

Steel mullion with malleable iron top and bottom plates; furnished with zinc plated fasteners for metal frames and concrete floors. May be cut, drilled and tapped in the field for Rim Exit Devices. CR900 series mullions are primed for painting, BHMA 600, red.

CR900 Series Mullions - How to Order

Removable Mullions

UL Fire Rating ¹	Mullion Opening Height ²	Catalog Number
Panic Only	Up to 7'2"	CR972
Panic Only	Up to 10'0"	CR910
3-Hour	Up to 7'2" (Only fire rated up to 8')	CR972A
3-Hour	Up to 10'0"	CR910A ⁴

Key Removable Mullions

UL Fire Rating ¹	Mullion Opening Height ²	Catalog Number
1-1/2 Hour	Up to 7'2"	CR972BKM ³
1-1/2 Hour	Up to 10'0" (Only fire rated up to 8')	CR910BKM ^{3,4}

Notes:

1. UL label on mullion indicates listing.
2. May be field cut for doors.
3. Cylinder and collars not included, specify separately. See Cylinders on page 12.
4. For 8' length Mullion must be ordered as 10' length and cut in the field to 8' size

CR900 Series Mullions - Options

M95- Spacer Block

Recommended for double rabbeted frames where the stop face width is less than the mounting hole spacing and also for door frames 5-3/4" (176mm) or less. To order with a mullion, specify M95. To order separately, specify Part No. 683F29-8.

M96- Angle Bracket

Recommended for any header configuration with less than 3" (76mm) of mounting surface. To order with a mullion, specify M96. To order separately, specify Part No. 655F63-8.

M57- Mullion Stabilizer Kit

Controls the movement of the mullion. Recommended for opening over 7' high, or whenever door movement must be minimized. To order with mullion, specify M57. To order separately, specify Part No. 653F11-1 x 695 or 628.

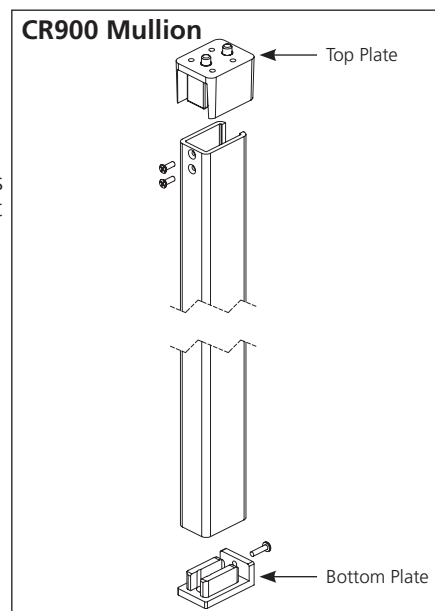

How to Order

ED2000 Series

Ordering Examples

Rim Exit Device

Quantity	Exit Device	Finish
20	ED2200	689

Removable Mullion

Quantity	Mullion
6	CR972A

Where to find ordering information and Quick Codes

Functions and Trims	Pages 8-10
Rim and Vertical Rod	Pages 8-10
Removable Mullion	Pages 13
Finish	Page 15
Handing	Page 15
Cylinders and Keying	Page 15
Door Thickness	Page 16
Strike	Page 16
Door Width	Page 16
Door Height	Page 16
Miscellaneous Options	Page 16

Rim Exit Device with Trim

Quantity	Exit Device	Trim/ Function	Finish		Hand	Door Thickness	Door Width	Misc. Options
			Trim	Device				
65	ED2200A	A510ET	626	689	LHR	D200	W048	M58

Vertical Rod Exit Device with Trim

Quantity	Exit Device	Trim/ Function	Finish		Hand	Door Thickness	Optional Strike	Door Width	Door Height	Misc. Options
			Trim	Device						
28	ED2400	N555ET	626	689	RHR	D214	S03	W048	H0800	M54

Contract/Detailed Order - Rim Exit Device with Trim

Quantity	Exit Device	Trim/ Function	Finish		Hand	Door Thickness	Door Width	Misc. Options	Cylinder/ Key Options	Keying	Keyset
			Trim	Device							
32	ED2200	P557ET	626	689	LHR	D200	W048	M54	C6	VKC3	AA1

Handing

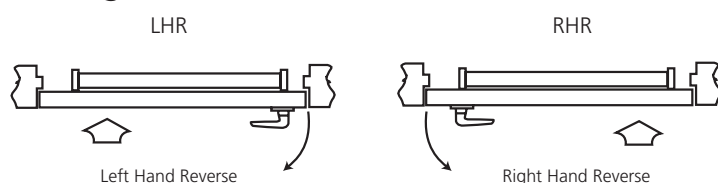

Note: Arrow (↔) indicates secure side of door.

Quick Codes

ED2000 Series

Cylinders and Keying

Description	Specify
Conventional 6-pin	6P
Conventional 7-pin ³	7P
LFIC	
LFIC 6-pin	C6
LFIC 6-pin, Less Core	CL6
LFIC 6-pin with Temporary Construction Core (Red)	CT6R
LFIC 6-pin with Temporary Construction Core (Blue)	CT6B
LFIC 6-pin with Temporary Construction Core (Green)	CT6G
LFIC 6-pin with Temporary Disposable Core	CT6D
LFIC 7-pin ³	C7
LFIC 7-pin, Less Core ³	CL7
LFIC 7-pin with Temporary Construction Core (Red) ³	CT7R
LFIC 7-pin with Temporary Construction Core (Blue) ³	CT7B
LFIC 7-pin with Temporary Construction Core (Green) ³	CT7G
LFIC 7-pin with Temporary Disposable Core ³	CT7D
SFIC	
SFIC 6-pin	C6S
SFIC 6-pin with Temporary Construction Core (Blue) ³	CT6SB
SFIC 6-pin Less Core	CLS6
SFIC 6-pin with SFIC Disposable Temporary Core ³	CT6SD
SFIC 7-pin	C7S
SFIC 7-pin with Temporary Construction Core (Blue)	CT7SB
SFIC 7-pin, Less Core	CLS7
SFIC 7-pin with SFIC Disposable Temporary Core	CT7S
Security	
Security	HS
Security LFIC ³	CHS
Access 3®	
Access 3® - Patented	AP
Access 3® - Security	AS
Access 3® - High Security	AHS
Access 3® LFIC - Patented ³	ACP
Access 3® LFIC - Security ²	ACS
Access 3® LFIC - High Security ³	ACHS
Pyramid	
Pyramid Security Fixed Core	PS
Pyramid Security LFIC	PCS
Pyramid High Security Fixed Core	PHS
Pyramid High Security LFIC	PCHS
Pyramid LFIC with Temporary Construction Core	CTP
Pyramid LFIC with Temporary Disposable Core	CTPD
Pyramid LFIC Less Core	CLP
Keying and Keys	
0-bitted with 2 blank keys	(standard)
Keyed Random	KR
Construction Master Keyed ¹	CMK
Master Keyed (all cylinders except (8000, 8020, 8027, 8200))	specify keyset
Master Keyed Pyramid	specify keyset
Master Keyed Security (including LFIC cylinder and core)	specify keyset
Master Keyed 8000, 8020, 8027, 8200	specify keyset
Master Keyed to customer bittings or sample key	specify keyset

Cylinders and Keying (cont.)

Description	Specify
Visual key control (VKC)	
No biting or keyset stamping on keys	VKC0
Keys only	VKC1
Cylinders and Keys ² (not for AS, AHS, ACS, ACHS, HS, CHS, PHS or PCHS)	VKC2
Cylinders Only ² (not for AS, AHS, ACS, ACHS, HS, CHS, PHS or PCHS)	VKC3
Concealed key control (CKC)	
CKC Cylinders with VKC Keys	CKC2
CKC Cylinders Only ² (not for AS, AHS, ACS, ACHS, PHS, PCHS)	CKC3

Notes:

1. CMK construction master keying is not available in Pyramid or Security Series.
2. VKC2, VKC3, CKC3 are not available in Pyramid or Security series.
3. Not available for 500ET trim.

Handing

Hand	Specify
Right Hand Reverse	RHR
Left Hand Reverse	LHR

Finishes

Description	Specify
Silver Aluminum Painted	689
Dark Bronze Painted	690
Light Bronze Painted	691
Black Painted	693
Satin Chromium Plated (Trim Only)	626
Satin Stainless Steel (Trim Only)	630
Black Suede Powder Coat	BSP
White Suede Powder Coat	WSP

Lock Finish

Description	Cylinder/Core*
605,606,611,612,613,690,691,722	606
618,619,622, 625,626,626C,689,WSP	626
BSP	BSP
WSP	WSP

*Finish when cylinder provided with lock

Quick Codes

ED2000 Series

Door Thickness

Door	Specify
1-3/4" (44mm)	(standard)
2" (51mm)	D200
2-1/4" (57mm)	D214

*A5, N5, PR5 series trims only.

Door Width

Door	Specify
36" (914mm)	(standard)
42" (1067mm)	W042
48" (1219mm)	W048

Door Height

Door	Specify
7'0" (2.13m) (ED2400 devices)	(standard)
8'0" (2.44m) (ED2400A devices)	(standard)

Strike

Description	Specify
Rim	
Rim x vertical rod	S02
Vertical Rod	
Flush bottom (ED2400 devices only)	S09

Miscellaneous Options

Description	Specify
Lever to accept Best® type core (N6 and PR6 trims only)	M08
Lever to accept <i>Schlage</i> IC core	M69
Less dogging	M51
Sex nuts and bolts (SNBs) ¹	M54
Mullion stabilizer kit	M57
Shim kit (for vision light)	M58

How to Specify

ED2000 Series

Suggested Specification

All exit devices shall be ED2000 Series Touchbar Exit Devices as manufactured by Corbin Russwin Architectural Hardware.

The maximum exit device projection shall be 2-1/2" (64mm). The exit device bar shall be constructed of heavy wrought steel. The touchbar shall be constructed of wrought steel; scalped pushpads or pushpads with plastic or Lexan coatings shall not be acceptable. The touchbar shall cover the entire length of the devices. Pushpads which cover less than the entire length of the device shall not be acceptable. Nylon bearings and stainless steel springs shall be used for long life and durability; only torsion springs are acceptable. All device covers shall be of aluminum; plastic or metal stamping shall not be acceptable. Mounting screws shall be concealed to deter tampering. All ferrous parts shall be zinc coated to prevent rusting.

Single point, one quarter turn hex key dogging shall be standard on non-fire-rated devices.

All devices shall be listed by Underwriters Laboratories for safety as panic hardware. Fire rated devices shall be UL/C-UL listed for A label and lesser class doors, 4' x 8' single and 8' x 8' pair. The model number shall be located on the end cap; devices having the model number located other than on the end cap shall not be acceptable.

On trims with cylinders, the locking and unlocking of the trim shall be housed in the trim and not in the active head of the device. Trim shall be throughbolted and fasteners shall be concealed.

All trims shall be furnished in architectural finishes and shall match the trims and finishes on corresponding locksets.

Certification:
ANSI A156.3, Grade 1

All devices, trims and cylinders shall be from one manufacturer.

All devices and trims shall carry a one-year limited warranty.

The ASSA ABLOY Group is the global leader in access solutions. Every day, we help billions of people experience a more open world.

ASSA ABLOY Opening Solutions leads the development within door openings and products for access solutions in homes, businesses and institutions. Our offering includes doors, frames, door and window hardware, mechanical and smart locks, access control and service.



For additional information, contact your
ASSA ABLOY Door Security Solutions
sales consultant or visit www.corbinrusswin.com.

In U.S.

Corbin Russwin
Architectural Hardware
225 Episcopal Road
Berlin, CT 06037
Phone: 800-543-3658
Fax: 800-447-6714
corbinrusswin.com

In Canada

ASSA ABLOY Door
Security Solutions Canada
160 Four Valley Drive
Vaughan, Ontario
Canada L4K 4T9
Phone: 800-461-3007
Fax: 800-461-8989
www.assaabloydss.ca

MicroShield®

As part of their promise to provide innovative solutions to their customers, certain ASSA ABLOY Group brands offer the MicroShield® technology, a silver-based antimicrobial coating designed to inhibit the growth of bacteria.

Microshield® is a registered trademark of ASSA ABLOY Access and Egress Hardware Group, Inc.



The Agion antimicrobial is not intended as a substitute for good hygiene. Coated products must still be cleaned to ensure the surfaces will be free of destructive microbes. ASSA ABLOY makes no representations or warranties, express or implied, as to the efficacy of the Agion antimicrobial. A copy of the Agion warranty is available upon request. Agion is a registered trademark of Agion Technologies, Inc., Wakefield, MA, USA