

**Corbin
Russwin**

ASSA ABLOY

ED6000 Series

Crossbar Exit Devices



ASSA ABLOY, the global leader
in door opening solutions



Introduction

ED6000

ED6000 Series



Applications

Since patenting some of the first exit devices nearly a century ago, Corbin Russwin has met rigorous life safety and security requirements, while offering pleasing aesthetics and trouble-free operation. Designed for applications in high-use, high-abuse situations, ED6000 Crossbar Exit Devices can be teamed with a variety of Corbin Russwin trims to provide desired functions, styles and finishes in new construction and renovations, including:

- Schools and universities
- Health care facilities
- Government and municipal buildings
- Commercial and industrial
- Office and retail complexes
- Transportation facilities
- Hotels and conference centers
- Religious facilities

Advantages

- Meets ANSI Grade 1 requirements
- Heavy-duty construction
- Base metals (brass, bronze and stainless steel) for durability
- Easy-to-use crossbar operation for quick egress and ADA compliance
- Dogging standard on all panic listed devices
- Thru-bolted trims for strength and security
- Wide range of finishes, trims and styles to match other Corbin Russwin products
- Devices available to satisfy panic and fire opening requirements

Table of Contents





Introduction.....	2
Applications and Listings.....	3
Rim Exit Features.....	5
Surface Vertical Rod Exit Features..	7
Rim/Surface Vertical Rod	
Trims and Functions	9
Fire-Rated Rim Exit Features	13
Fire-Rated Rim Trims	
and Functions	15
Mortise Exit Features.....	18
Mortise Trims and Functions	20
Concealed Vertical Rod	
Exit Features	24
Concealed Vertical Rod	
Trims and Functions.....	26
ED66900 ECE Applications.....	27
ECE Features.....	28
ECE Functions	29
Options and Accessories	30
Mullions.....	33
Cylinders.....	34
How to Order	35
Quick Codes	36
Helpful Terms	38
How to Specify	39

Applications and Listings

ED6000

UL UL listed as fire exit hardware by Underwriters Laboratories Inc.

Single Door

	Max. Door Opening	Fire Door Ratings					Application	
		A	B, D	C, E				
		3 Hr.	90 Min.	45 Min.	30 Min.	20 Min.		
Rim								
ED6200	4'*	Devices are panic listed only.					Surface applied; single point latching.	
ED6200A	4' x 7'2"	UL	UL	UL	UL	UL		
Vertical Rod								
ED6400	4' x 10'	Devices are panic listed only.					Surface applied; two point latching.	
ED6400A	4' x 7'2"	Fire ratings do not apply for single door applications.						
Mortise								
ED6600	4'*	Devices are panic listed only.					Mortised in door; two point latching.	
ED6600A	4' x 7'2"	UL	UL	UL	UL	UL		
Concealed Vertical Rod								
ED6800	4' x 10'8"	Devices are panic listed only.					Rods concealed in door; two point latching.	
ED6800A	4' x 7'2"	Fire ratings do not apply for single door applications.						

Pair of Doors with Removable Mullion

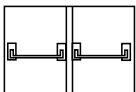
	Max. Door Opening	Fire Door Ratings					Application	
		A	B, D	C, E				
		3 Hr.	90 Min.	45 Min.	30 Min.	20 Min.		
Rim x Rim								
ED6200 x ED6200 x 507	8' x 7'2"	Devices are panic listed only.					2 independent, active doors with removable mullion.	
ED6200 x ED6200 x 510	8' x 10'	Fire ratings do not apply.						
ED6200A x ED6200A x 507	8' x 7'2"	UL	UL	UL	UL	UL		

*UL does not set a door height limitation on panic applications.

Applications and Listings

ED6000

Pair of Doors

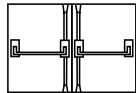
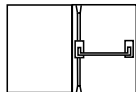
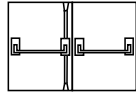
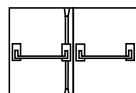
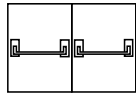
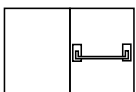
	Max. Door Opening	Fire Door Ratings					Application	
		A	B, D	C, E				
		3 Hr.	90 Min.	45 Min.	30 Min.	20 Min.		
Vertical Rod (Swinging in the Same Direction)								
ED6400 x ED6400	8'*	Devices are panic listed only.					2 independent doors with 2 point latching – overlapping astragal not required.	
ED6400A x ED6400A	8' x 7'2"	—	UL	UL	UL	UL		
Vertical Rod (Swinging in Opposite Directions)								
ED6400 x ED6400	8'*	Devices are panic listed only.					2 independent doors with 2 point latching – overlapping astragal required for 3 hour openings.	
ED6400A x ED6400A	8' x 7'2"	UL	UL	UL	UL	UL		
Vertical Rod x Mortise								
ED6400 x ED6600	8'*	Devices are panic listed only.					Overlapping astragal required for 3 hour openings. Coordinator required with standard strike.	
ED6400A x ED6600A	8' x 7'2"	UL	UL	UL	UL	UL		
ED6400A x ED6600A x Open back strike	8' x 7'2"	—	UL	UL	UL	UL		
Vertical Rod x Rim								
ED6400 x ED6200 x S02	8'*	Devices are panic listed only.					Non-prepped doors only; S02 strike required on inactive door; coordinator recommended.	
Concealed Vertical Rod (Swinging in the Same Direction)								
ED6800 x ED6800	8'*	Devices are panic listed only.					2 independent doors with 2 point latching – overlapping astragal not required.	
ED6800A x ED6800A	8' x 7'2"	—	UL	UL	UL	UL		
Concealed Vertical Rod (Swinging in Opposite Directions)								
ED6800 x ED6800	8'*	Devices are panic listed only.					2 independent doors with 2 point latching – overlapping astragal required for 3 hour openings.	
ED6800A x ED6800A	8' x 7'2"	UL	UL	UL	UL	UL		

*UL does not set a door height limitation on panic applications.



ED6200 Panic Listed Rim Exit Device

Features

Handing

Field reversible; specify hand.

Bar Length

Easily field cut to size.

Standard: 36" (914mm) bar fits up to 36" (914mm) door.

Optional: 48" (1219mm) bar fits up to 48" (1219mm) door; specify W048.

Door Thickness

1-3/4" (44mm) standard.

Optional: 2" (51mm); specify D200.

Optional: 2-1/4" (57mm); specify D214.

Backset

2-5/8" for 1/2" stop, 2-3/4" for 5/8" stop. (Backset changes when mullion is used.)

Stile

Minimum width with 1/2" stop and standard strike 4" (102mm).

Latchbolt

3/4" (19mm) pivoted.

Materials

Brass, bronze or stainless steel.

Cases

Heavy wrought, 7-1/4" (184mm) x 2-9/16" (65mm).

Projection

5-3/4" (146mm); 4-1/2" (114mm) depressed.

Crossbar

Standard: 13/16" (1mm) x 1-3/8" (35mm) oval seamless tubing.

Optional: reinforced crossbar or stainless steel crossbar; see Quick Codes, page 36.

Dogging

Standard on ED6200 devices.

Optional: less dogging; specify M51.

Fasteners

Standard: machine screws.

Optional: sex nuts and bolts or spanner head screws; specify M54.

Strike:

See Options and Accessories, page 30.

Removable Mullion

See Mullions, page 33.

Functions and Trims

Thru-bolted lever, knob, pull and thumbpiece trims available with wide range of functions; see Trims and Functions, page 9.

Cylinders

Cylinder not included unless specified. See How to Order, page 34.

Applications and Listings

See page 3.

Warranty

One-year limited.

Certification/Compliance

ANSI

Meets A156.3, Grade 1.

Meets A117.1 Accessibility Code.

C-UL US

All devices listed for safety as panic hardware; devices comply with UL 305 standards for panic hardware. UL symbol on active case cover indicates listing.

California State Reference Code

This product has been approved by the California State Fire Marshal pursuant to section 13144.1 of the California Health and Safety Code.

NFPA

All exit devices comply with NFPA 101 Life Safety Code.

ADA

Exit devices, lever trims and pulls comply with Americans with Disabilities Act.

Finishes

BHMA 605	Bright Brass	
BHMA 606	Satin Brass	
BHMA 611	Bright Bronze	
BHMA 612	Satin Bronze	
BHMA 613	Oxidized Bronze, oil rubbed, available lacquered	
BHMA 618	Bright Nickel Plated	
BHMA 619	Satin Nickel Plated	
BHMA 622	Flat Black Coated	
BHMA 625	Bright Chromium Plated	
BHMA 626	Satin Chromium Plated	
626C	Satin Chromium Plated with MicroShield®	
BHMA 629	Bright Stainless Steel	
BHMA 630	Satin Stainless Steel	
630C	Satin Stainless Steel with MicroShield®	
BHMA 722	Black oxidized bronze, oil rubbed	

Rim Exit Features

ED6000

ED6200 Rim Exit Device

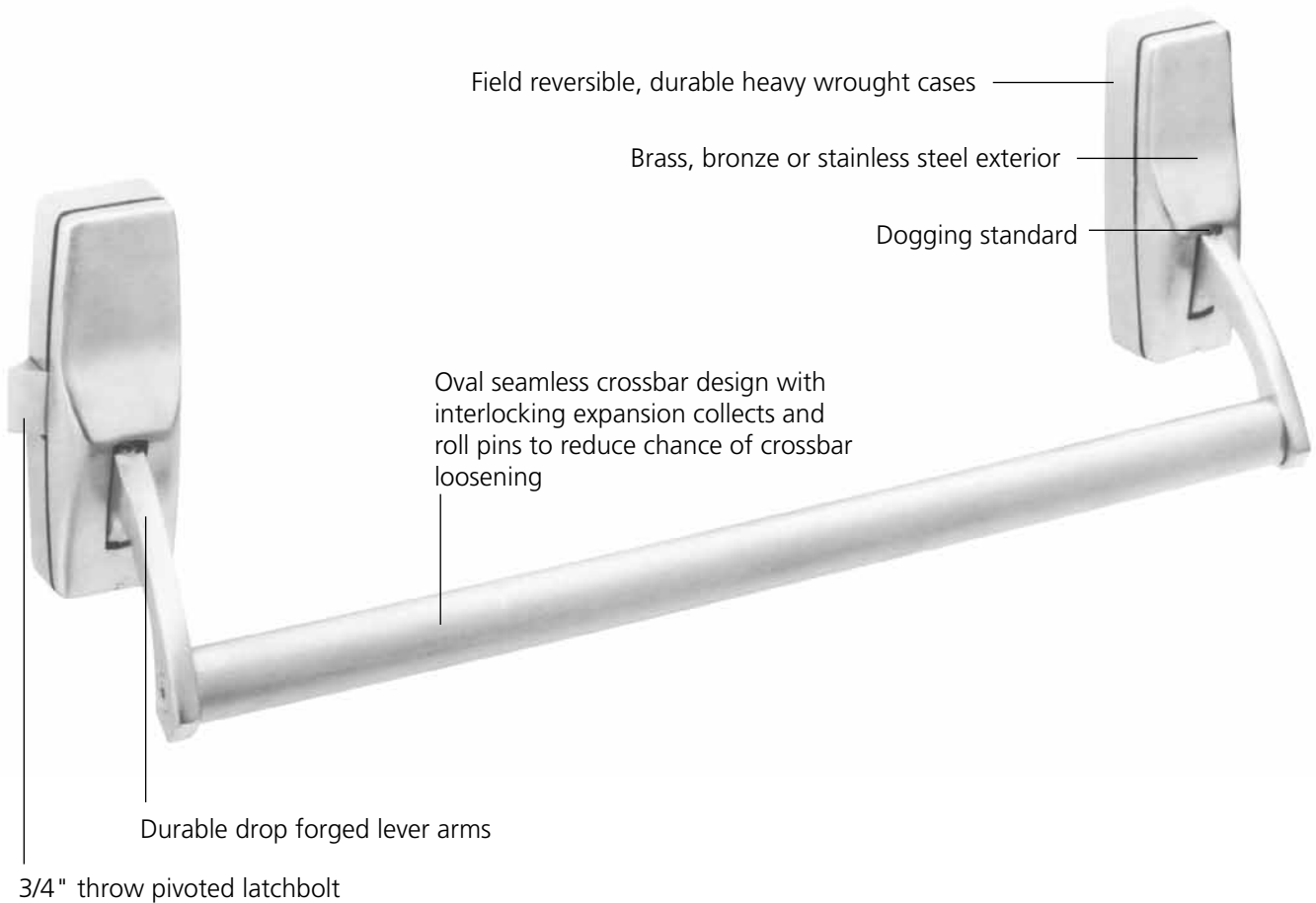

Surface Vertical Rod Exit Features

ED6000

ED6400 Panic Listed Vertical Rod Exit Device ED6400A 3-Hour Fire Listed Vertical Rod Exit Device

Features

Handing

Device handed but easily field reversible; specify hand.

Bar Length

Easily field cut to size.

Standard: 36" (914mm) bar fits up to 36" (762mm-914mm) door.

Optional: 48" (1219mm) bar fits up to 48" (1219mm) door; specify W048.

Door Thickness

1-3/4" (44mm) standard.

Optional: 2" (51mm); specify D200.

Optional: 2-1/4" (57mm); specify D214.

Backset

2-3/4" (70mm).

Stile

Minimum width 4-1/8" (105mm).

Door Height

All top rods easily field cut to size.

Standard on ED6400 devices; top rod for doors up to 7'6".

Optional on ED6400 devices; top rod for doors up to 10'; see How to Order, page 35.

Standard on ED6400A devices; top rod for 7'2" door.

Latchbolt

ED6400 devices:

Top: 5/8" throw.

Bottom: 3/4" throw; acts independently, allowing top latch to remain engaged even when bottom latch is not projected.

ED6400A devices:

Top: 3/4" steel, jamb mounted; projects into pusher on device.

Bottom: 3/4" throw steel.

Latchbolt Operation

Standard on ED6400 and ED6400A devices: latchbolts held in retracted position until door closes.

Optional on ED6400 devices: free-latching latchbolts; see How to Order, page 35.

Vertical Rods

Inverted U-shaped rectangular.

Materials

Brass, bronze or stainless steel.

Cases

Heavy wrought, 7-1/4" (184mm) x 2-9/16" (65mm).

Crossbar

Standard: 13/16" (1mm) x 1-3/8" (35mm) oval seamless tubing.

Optional: reinforced crossbar or stainless steel crossbar; see Quick Codes, page 36.

Dogging

Standard on ED6400 devices.

Optional: less dogging; specify M51.

Dogging not available on ED6400A devices.

Projection

5-3/4" (146mm); 4-1/4" (108mm) depressed.

Fasteners

Standard on ED6400 devices: machine screws.

Optional on ED6400 devices: sex nuts and bolts; specify M54.

Standard on ED6400A devices; sex nuts and bolts.

Optional on ED6400 and ED6400A devices; spanner head screws; specify M02.

Strike

See Options and Accessories, page 31.

Functions and Trims

Thru-bolted lever, knob, pull and thumbpiece trims available with wide range of functions; see Trims and Functions, page 9.

Cylinders

Cylinder not included unless specified. See How to Order, page 34.

Applications and Listings

See page 3.

Warranty

One-year limited.

Certification/Compliance

ANSI

Meets A156.3, Grade 1.

C-UL US

All devices listed for safety as panic hardware; devices comply with UL 305 standards for panic hardware. 3-hour fire-rated devices listed as fire exit hardware for A label and lesser class 8' x 7'2" double doors. UL symbol on active head indicates listing.

Any retrofit or other field modification to a fire-rated opening can potentially impact the fire rating of the opening, and Corbin Russwin, Inc. makes no representations or warranties concerning what such impact may be in any specific situation. When retrofitting any portion of an existing fire-rated opening, or specifying and installing a new fire-rated opening, please consult with a code specialist or local code official (Authority Having Jurisdiction) to ensure compliance with all applicable codes and ratings.

California State Reference Code

This product has been approved by the California State Fire Marshal pursuant to section 13144.1 of the California Health and Safety Code.



NFPA

All exit devices comply with NFPA 101 Life Safety Code. All fire-rated devices comply with NFPA 80 Fire Doors and Windows.

ADA

Lever trims and pulls comply with Americans with Disabilities Act.

Finishes

BHMA 605	Bright Brass
BHMA 606	Satin Brass
BHMA 611	Bright Bronze
BHMA 612	Satin Bronze
BHMA 613	Oxidized Bronze, oil rubbed, available lacquered
BHMA 618	Bright Nickel Plated
BHMA 619	Satin Nickel Plated
BHMA 622	Flat Black Coated
BHMA 625	Bright Chromium Plated
BHMA 626	Satin Chromium Plated
626C	Satin Chromium Plated with MicroShield® 
BHMA 629	Bright Stainless Steel
BHMA 630	Satin Stainless Steel
630C	Satin Stainless Steel with MicroShield® 
BHMA 722	Black oxidized bronze, oil rubbed

Surface Vertical Rod Exit Features

ED6000

ED6400 Vertical Rod Surface Exit Device

ED6400A Vertical Rod Surface Exit Device

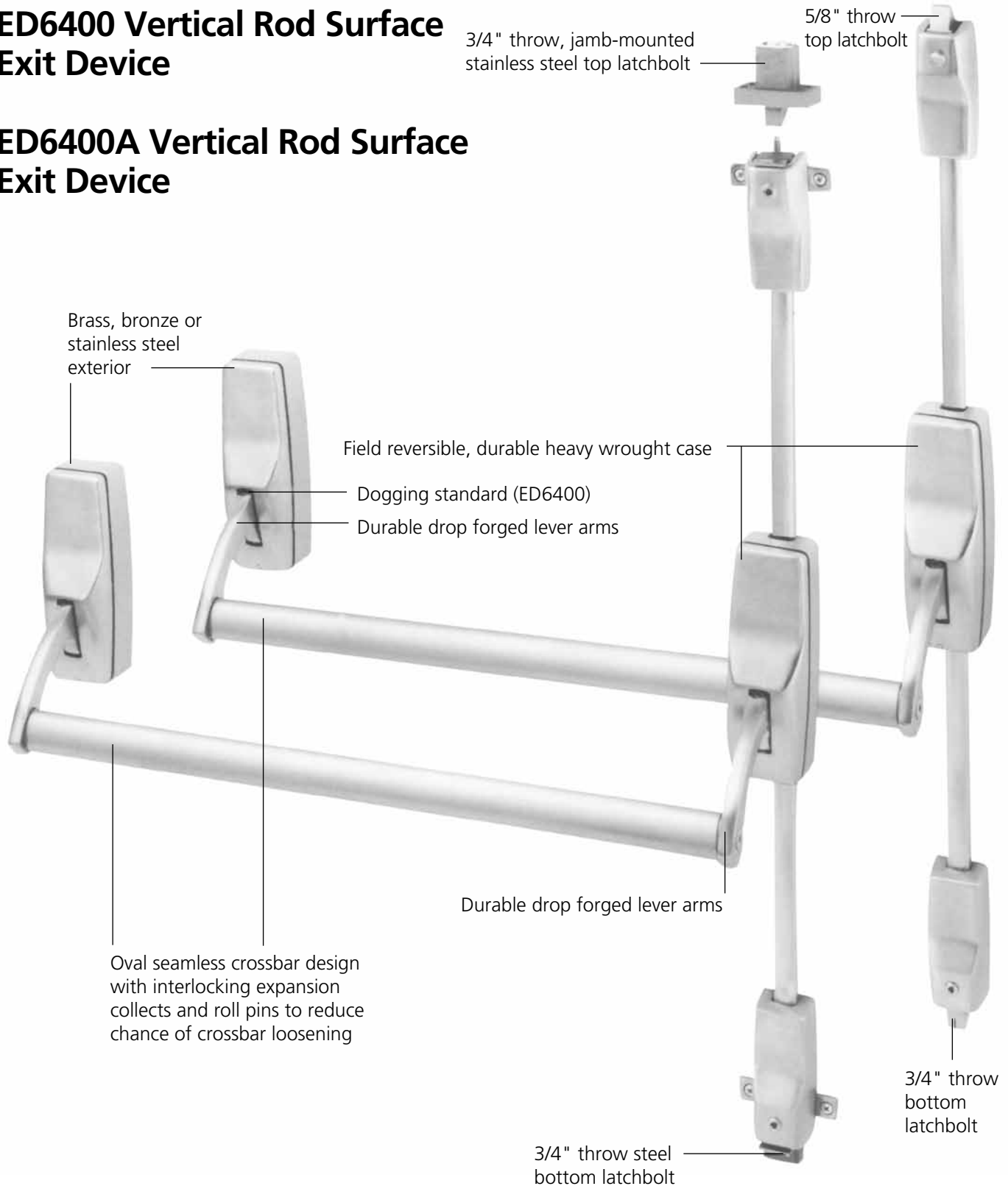

Rim/SVR Trims and Functions



ED6000

Device Only

Rim Exit Device	ANSI Type	Type	ANSI No.	Function Description
ED6200	2	Exit Only	01	Exit only; no trim. (Accepts all trims listed on pages 9-12).
Vertical Rod Exit Device	ANSI Type	Type	ANSI No.	Function Description
ED6400	2	Exit Only	01	Exit only; no trim.
ED6400A	2	Exit Only	01	3-hour fire-rated exit only; no trim.



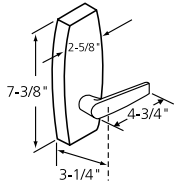

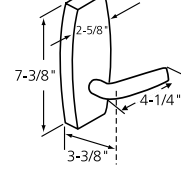





Device with Trim

Vertical Rod Exit Device	Accepts Trim/Function			Function Description (See Trim Designs Below)
	ANSI Type	Type	ANSI No.	
ED6410	2	Passage (10)	—	- Free at all times.
ED6410A	2	Passage (10)	—	- 3-hour fire-rated; free at all times.
ED6450	2	Dummy (50)	02	- Always rigid.
ED6450A	2	Dummy (50)	02	- 3-hour fire-rated; always rigid.
ED6410	2	Classroom (55)	05/08	- Free at all times, except when locked by key.
ED6410A	2	Classroom (55)	05/08	- 3-hour fire-rated; free at all times, except when locked by key.
ED6457	2	Classroom (55)	03/04/06	- Free only when key is turned. Key removable only when locked. - Not available fire-rated.
ED6458	2	Latch Hold-Back x Nighlatch Trim (57)	04/06	- Always inactive. Locked except when latch is held in retracted position by key. (Outside cylinder dogging) - Not available on fire-rated devices.

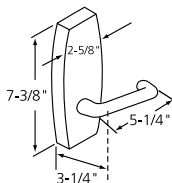
Pull Trim Design		Trim/Function				
		Passage ANSI No. 14	Dummy ANSI No. 02	Classroom ANSI No. 08	Nighlatch ANSI No. 03	
	Armstrong A3 Lever: Cast Escutcheon: Cast Cylinder: Rim		A310	A350	A355	A357
	Citation C2 Lever: Cast Escutcheon: Cast Cylinder: Rim		C210	C250	C255	C257



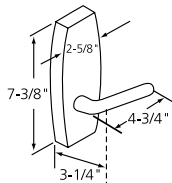





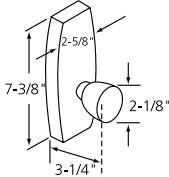

Rim/SVR Trims and Functions

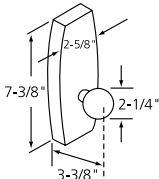
ED6000

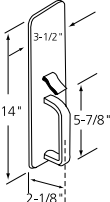
Pull Trim Design				Trim/Function			
				Passage ANSI No. 14	Dummy ANSI No. 02	Classroom ANSI No. 08	Nightlatch ANSI No. 03/04
	<p>Dirke D2</p> <p>Lever: Cast Escutcheon: Cast Cylinder: Rim</p>			D210	D250	D255	D257
	<p>Essex E2</p> <p>Lever: Cast Escutcheon: Cast Cylinder: Rim</p>			E210	E250	E255	E257
	<p>Lustra L2</p> <p>Lever: Cast Escutcheon: Cast Cylinder: Rim</p>			L210	L250	L255	L257
	<p>Newport N3</p> <p>Lever: Cast Escutcheon: Cast Cylinder: Rim</p>			N310	N350	N355	N357
	<p>Regis R2</p> <p>Lever: Cast Escutcheon: Cast Cylinder: Rim</p>			R210	R250	R255	R257
	<p>Princeton PR2</p> <p>Lever: Cast Escutcheon: Cast Cylinder: Rim</p>			PR210	PR250	PR255	PR257

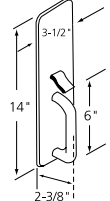
Rim/SVR Trims and Functions

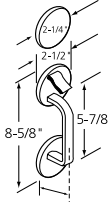
ED6000

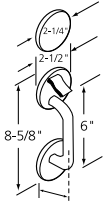



Pull Trim Design	Trim/Function				
	Passage ANSI No. 14	Dummy ANSI No. 02	Classroom ANSI No. 08	Nightlatch ANSI No. 03/04	
 <p>Belmont B3 Knob: Wrought reinforced Escutcheon: Cast Cylinder: Rim</p>		B310	B350	B355	B357*
 <p>Global G4 Knob: Wrought reinforced Escutcheon: Cast Cylinder: Rim</p>		G410	G450	G455	G457*
 <p>D Grip T3 Grip: Extruded Escutcheon: Wrought Cylinder: Rim</p>		T310	T350	T355	T357*
 <p>Round Grip T4 Grip: Extruded Escutcheon: Wrought Cylinder: Rim</p>		T410	T450	T455	T457*
 <p>D Grip Sectional T5 Grip: Extruded Cylinder: Rim</p>		T510	T550	T555	T557*
 <p>Round Grip Sectional T6 Grip: Extruded Cylinder: Rim</p>		T610	T650	T655	T657*

*When used with ED6458 device, provides latch hold-back for ANSI No. 04 function.

Offset Pull Trims

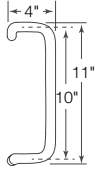
ED6000

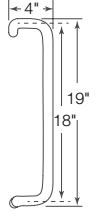
Offset Pull Trim: P12, P13, P14*

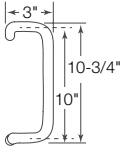
	<p>Offset Pull P12 Clearance: 2-1/2 "</p>		<p>Specify Part Number, 716F50M x Finish¹</p>
	<p>Offset Pull P13 Clearance: 2-1/2 "</p>		<p>Specify Part Number, 716F51M x Finish¹</p>
	<p>Offset Pull P14 Clearance: 2-1/2 "</p>		<p>Specify Part Number, 716F52M x Finish¹</p>

1. Available in 605, 606, 612, 613, 626, 629 and 630 finishes.

*Available on 1-3/4" thick doors only



ED6200A 3-Hour Fire Listed Rim Exit Device

Features

Handing

Handed; specify hand.

Bar Length

Easily field cut to size.

Standard: 36" (914mm) bar fits up to 36" (762mm-914mm) door.

Optional: 48" (1219mm) bar fits up to 48" (1219mm) door; specify W048.

Door Thickness

1-3/4" (44mm) standard.

Optional: 2" (51mm); specify D200.

Optional: 2-1/4" (57mm); specify D214.

Backset

2-3/4" (70mm) with 6/8" (19mm) stop.
(Backset changes when mullion is used.)

Stile

Minimum width with 5/8" stop and standard strike: 4-1/8" (105mm).

Latchbolt

3/4" (19mm) throw stainless steel, with stainless steel deadlocking plunger.

Materials

Brass, bronze or stainless steel.

Cases

Heavy wrought, 8-3/8" (213mm) x 2-5/8" (67mm).

Crossbar

Standard: 13/16" (1mm) x 1-3/8" (35mm) oval seamless tubing.

Optional: reinforced crossbar or stainless steel crossbar; see Quick Codes, page 36.

Dogging

Not available.

Projection

5-3/4" (146mm); 3" (76mm) depressed.

Fasteners

Sex nuts and bolts standard.

Optional: spanner head screws; specify M02.

Strike

See Options and Accessories, page 30.

Removable Mullion

See Mullions, page 33.

Functions and Trims

Thru-bolted lever, knob, pull and thumbpiece trims available with wide range of functions; see Trims and Functions, page 15.

Cylinders

Cylinder not included unless specified. See How to Order, page 34.

Applications and Listings

See page 3.

Warranty

One-year limited.

Certification/Compliance

ANSI

Meets A156.3, Grade 1.

Meets A117.1 Accessibility Code.

C-UL US

All devices listed for safety as panic hardware; devices comply with UL 305 standards for panic hardware. 3-hour fire-rated devices listed as fire exit hardware for A label and lesser class 8' x 7'2" double doors. UL symbol on active head indicates listing.

Any retrofit or other field modification to a fire-rated opening can potentially impact the fire rating of the opening, and Corbin Russwin, Inc. makes no representations or warranties concerning what such impact may be in any specific situation. When retrofitting any portion of an existing fire-rated opening, or specifying and installing a new fire-rated opening, please consult with a code specialist or local code official (Authority Having Jurisdiction) to ensure compliance with all applicable codes and ratings.

California State Reference Code

This product has been approved by the California State Fire Marshal pursuant to section 13144.1 of the California Health and Safety Code.



NFPA

All exit devices comply with NFPA 101 Life Safety Code. All fire-rated devices comply with NFPA 80 Fire Doors and Windows.

ADA

Exit devices, lever trims and pulls comply with Americans with Disabilities Act.

Finishes

BHMA 605	Bright Brass
BHMA 606	Satin Brass
BHMA 611	Bright Bronze
BHMA 612	Satin Bronze
BHMA 613	Oxidized Bronze, oil rubbed, available lacquered
BHMA 618	Bright Nickel Plated
BHMA 619	Satin Nickel Plated
BHMA 622	Flat Black Coated
BHMA 625	Bright Chromium Plated
BHMA 626	Satin Chromium Plated
626C	Satin Chromium Plated with MicroShield® 
BHMA 629	Bright Stainless Steel
BHMA 630	Satin Stainless Steel
630C	Satin Stainless Steel with MicroShield® 
BHMA 722	Black oxidized bronze, oil rubbed

Fire-Rated Rim Exit Features

ED6000

ED6200A Rim Exit Device

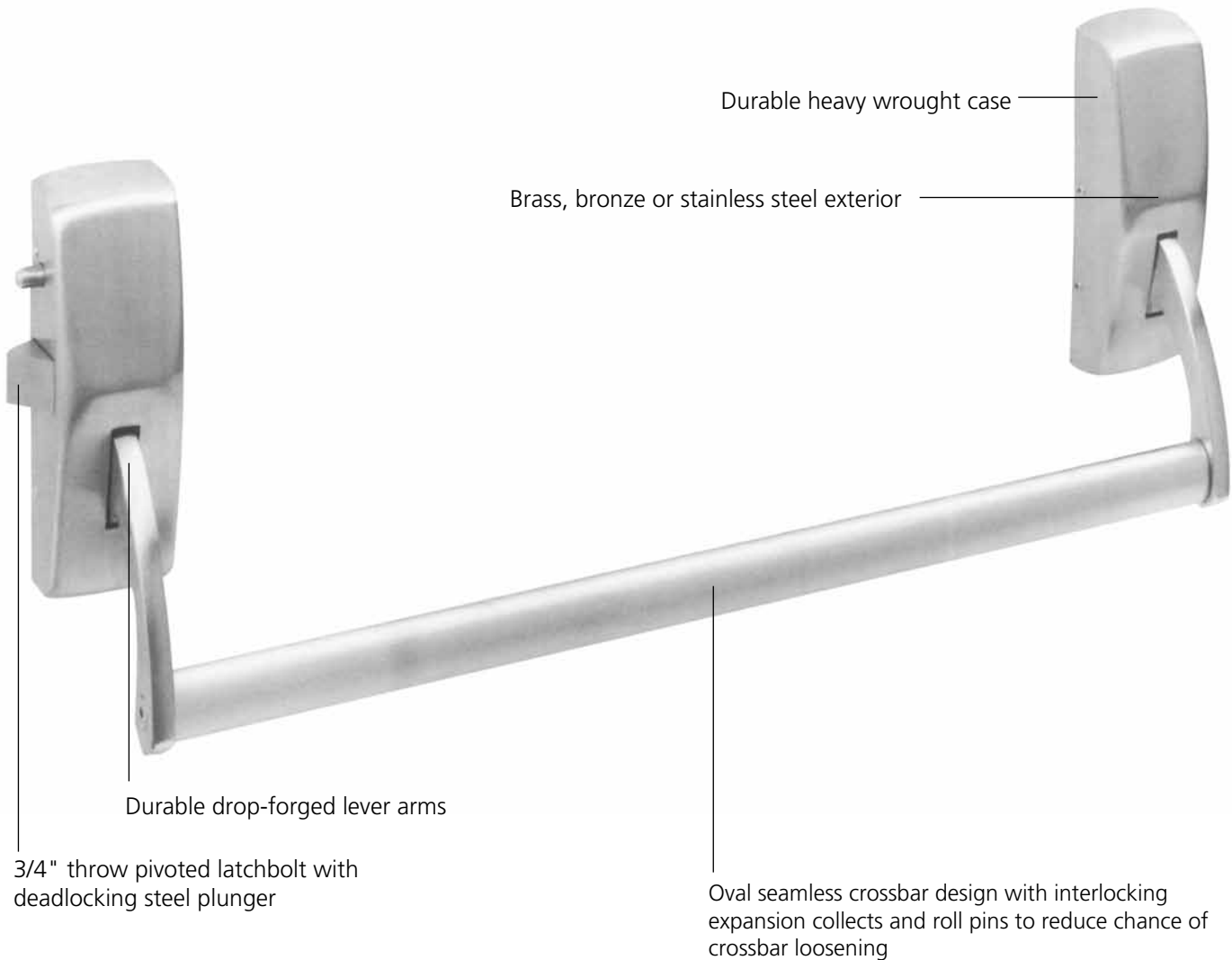

Fire-Rated Rim Trims and Functions





ED6000

Device Only

Rim Exit Device	ANSI Type	Type	ANSI No.	Function Description
ED6200A	1	Exit Only	01	3-hour fire-rated exit only; no trim. (Accepts all trims listed on pages 15-17.)



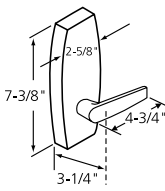

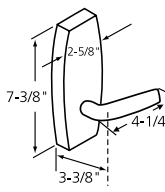



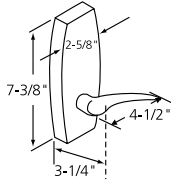

Device with Trim

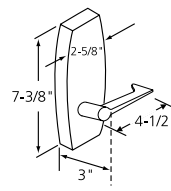
Rim Exit Device	ANSI Type	Accepts Trim/Function		Function Description (See Trim Designs Below)
		Type	ANSI No.	
ED6200A	1	Passage (10)	—	- 3-hour fire-rated; free at all times.
ED6200A	1	Dummy (50)	—	- 3-hour fire-rated; always free wheeling.
ED6200A	1	Classroom (55)	05/08	- 3-hour fire-rated; free at all times, except when locked by key.
ED6257A	1	Nightlatch (57)	03/04/06/06	- 3-hour fire-rated; always rigid. Entrance by trim when latchbolt is retracted by key. Key removable only when locked.

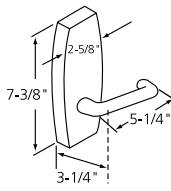
Pull Trim Design		Trim/Function					
		Passage	Dummy ANSI No. F02	Classroom ANSI No. F08	Nightlatch ANSI No. F03/F04/F06		
	Armstrong A4 Lever: Cast Escutcheon: Cast Cylinder: Rim			A410	A450	A455	A457
	Citation C3 Lever: Cast Escutcheon: Cast Cylinder: Rim			C310	C350	C355	C357

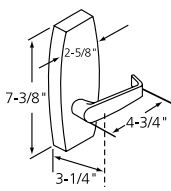

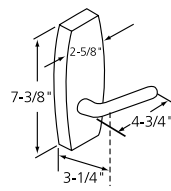

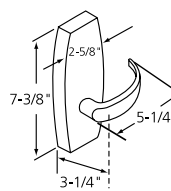

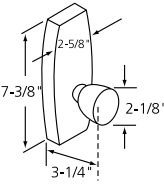

Fire-Rated Rim Trims and Functions

ED6000

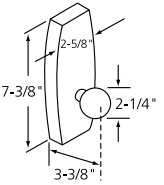
Pull Trim Design	Trim/Function			
	Passage	Dummy ANSI No. F02	Classroom ANSI No. F08	Nightlatch ANSI No. F03/F04/F06
 <p>Dirke D3 Lever: Cast Escutcheon: Cast Cylinder: Rim</p> 	D310	D350	D355	D357
 <p>Essex E3 Lever: Cast Escutcheon: Cast Cylinder: Rim</p> 	E310	E350	E355	E357
 <p>Lustra L3 Lever: Cast Escutcheon: Cast Cylinder: Rim</p> 	L310	L350	L355	L357
 <p>Newport N4 Lever: Cast Escutcheon: Cast Cylinder: Rim</p> 	N410	N450	N455	N457
 <p>Regis R3 Lever: Cast Escutcheon: Cast Cylinder: Rim</p> 	R310	R350	R355	R357
 <p>Princeton PR3 Lever: Cast Escutcheon: Cast Cylinder: Rim</p> 	PR310	PR350	PR355	PR357

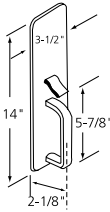
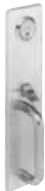
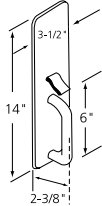
Fire-Rated Rim Trims and Functions

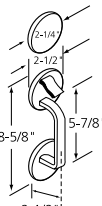
ED6000

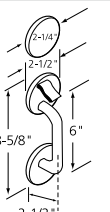
Pull Trim Design	Trim/Function				
	Passage	Dummy ANSI No. F02	Classroom ANSI No. F08	Nightlatch ANSI No. F03/F04/F06	
 <p>Belmont B4 Knob: Wrought reinforced Escutcheon: Cast Cylinder: Rim</p>		B410	B450	B455	B457
 <p>Global G5 Knob: Wrought reinforced Escutcheon: Cast Cylinder: Rim</p>		G510	G550	G555	G557
 <p>D Grip T7 Grip: Extruded Escutcheon: Wrought Cylinder: Rim</p>		T710	T750	T755	T757
 <p>Round Grip T8 Grip: Extruded Escutcheon: Wrought Cylinder: Rim</p>		T810	T850	T855	T857
 <p>D Grip Sectional T9 Grip: Extruded Cylinder: Rim</p>		T910	T950	T955	T957
 <p>Round Grip Sectional T10 Grip: Extruded Cylinder: Rim</p>		T1010	T1050	T1055	T1057

Mortise Exit Features

ED6000

ED6600 Panic-Listed Mortise Exit Device ED6600A 3-Hour Fire-Listed Mortise Exit Device



Features

Handing

Device handed but easily field reversible; specify hand. Strike is not field reversible.

Bar Length

Easily field cut to size.
Standard: 36" (914mm) bar fits up to 36" (762mm-914mm) door.
Optional: 48" (1219mm) bar fits up to 48" (1219mm) door; specify W048.

Door Thickness

1-3/4" (44mm) standard.
Optional: 2" (51mm); specify D200.
Optional: 2-1/4" (57mm); specify D214.

Backset

2-3/4" (70mm).

Stile

Minimum width 5" (127mm).

Projection

5-3/4" (146mm); 4-1/2" (114mm) depressed.

Latchbolt

Brass, 3/4" (19mm) throw.

Auxiliary Latch

Brass.

Front

8" x 1-1/4" (203mm x 32mm) heavy gauge steel.

Accommodates flat doors and doors beveled 1/8" (3mm) in 2" (51mm).

Latch Hold-Back

On ED6600 devices with keyed function trim, latchbolt may be held in retracted position by pushing in latchbolt and turning key.

Not available on ED6600A devices.

Materials

Brass, bronze or stainless steel.

Cases

Heavy wrought, 7-1/4" (184mm) x 2-9/16" (65mm).

Crossbar

Standard: 13/16" (1mm) x 1-3/8" (35mm) oval seamless tubing.

Optional: reinforced crossbar or stainless steel crossbar; see Quick Codes, page 36.

Dogging

Standard on ED6600 devices.
Optional less dogging; specify M51.
Dogging not available on ED6600A devices.

Fasteners

Standard on ED6600 devices: machine screws.
Optional on ED6600 devices: sex nuts and bolts; specify M54.
Standard on ED6600A devices; sex nuts and bolts.

Optional on ED6600 and ED6600A devices; spanner head screws; specify M02.

Strike

See Options and Accessories, page 32.

Functions and Trims

Thru-bolted lever, knob, pull and thumbpiece trims available with wide range of functions; see Trims and Functions, page 20.

Cylinders

Cylinder not included unless specified. See How to Order, page 34.

Applications and Listings

See page 3.

Warranty

One-year limited.

Certification/Compliance

ANSI

Meets A156.3, Grade 1.
Meets A117.1 Accessibility Code.

C-UL US

All devices listed for safety as panic hardware; devices comply with UL 305 standards for panic hardware. 3-hour fire-rated devices listed as fire exit hardware for A label and lesser class 4'x7'2" double doors. UL symbol on active head indicates listing.

Any retrofit or other field modification to a fire-rated opening can potentially impact the fire rating of the opening, and Corbin Russwin, Inc. makes no representations or warranties concerning what such impact may be in any specific situation. When retrofitting any portion of an existing fire-rated opening, or specifying

and installing a new fire-rated opening, please consult with a code specialist or local code official (Authority Having Jurisdiction) to ensure compliance with all applicable codes and ratings.

California State Reference Code

This product has been approved by the California State Fire Marshal pursuant to section 13144.1 of the California Health and Safety Code.



NFPA

All exit devices comply with NFPA 101 Life Safety Code. All fire-rated devices comply with NFPA 80 Fire Doors and Windows.

ADA

Exit devices, lever trims and pulls comply with Americans with Disabilities Act.

Finishes

BHMA 605	Bright Brass
BHMA 606	Satin Brass
BHMA 611	Bright Bronze
BHMA 612	Satin Bronze
BHMA 613	Oxidized Bronze, oil rubbed, available lacquered
BHMA 618	Bright Nickel Plated
BHMA 619	Satin Nickel Plated
BHMA 622	Flat Black Coated
BHMA 625	Bright Chromium Plated
BHMA 626	Satin Chromium Plated
626C	Satin Chromium Plated with MicroShield® 
BHMA 629	Bright Stainless Steel
BHMA 630	Satin Stainless Steel
630C	Satin Stainless Steel with MicroShield® 
BHMA 722	Black oxidized bronze, oil rubbed

ED6600 and ED6600A Mortise Exit Devices

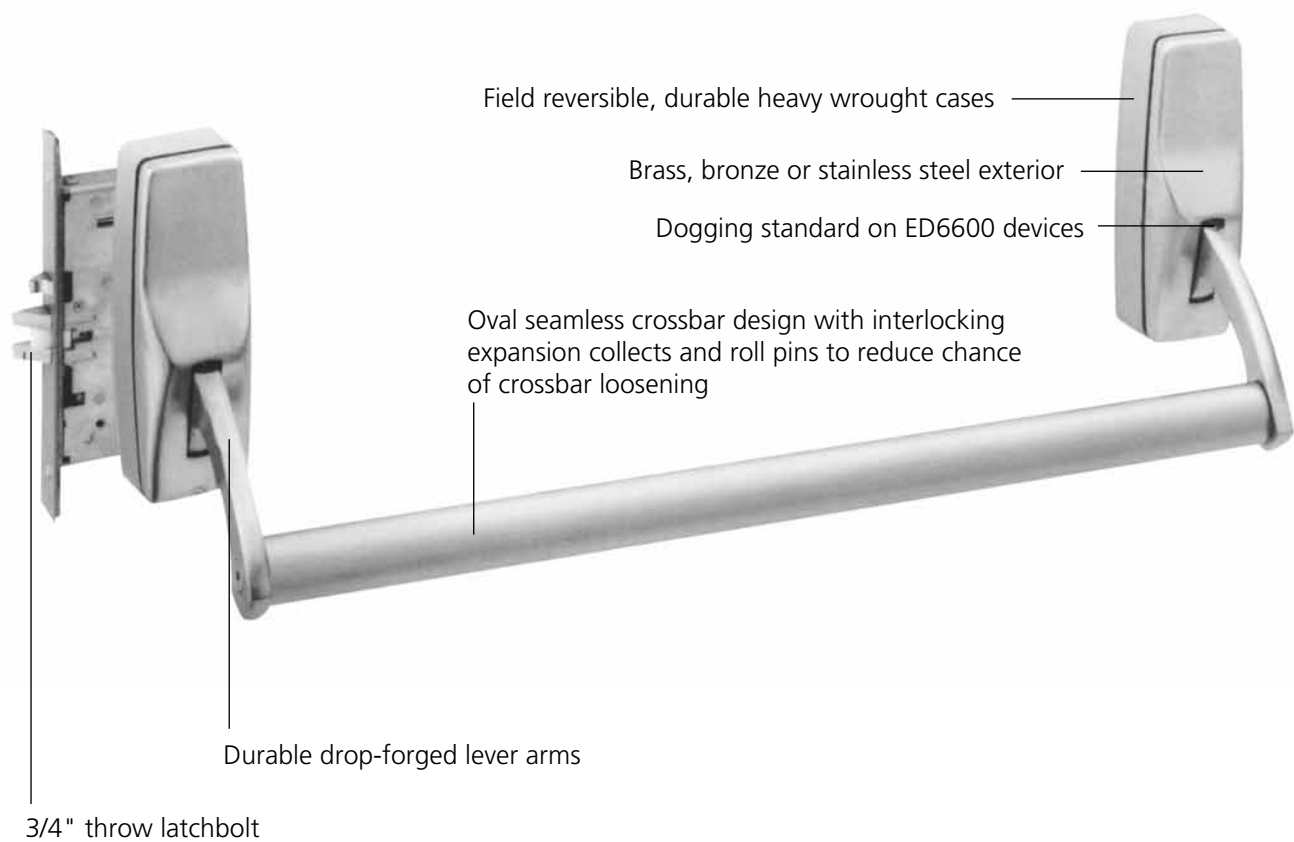





Mortise Trims and Functions

ED6000



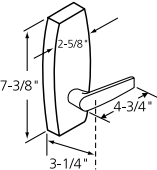

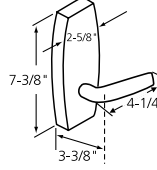





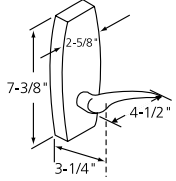

Mortise Exit Device	ANSI Type	Accepts Trim/Function		Function Description (See Trim Designs Below)
		Type	ANSI No.	
ED6600	3	Exit Only	F01	- Exit only; no trim. (Accepts all trims listed on pages 20-23.)
ED6600A	3	Exit Only	F01	- 3-hour fire-rated exit only; no trim. (Accepts all trims listed on pages 20-22.)
For Passage, Dummy, Classroom and Nightlatch functions, see Trim Designs below.		Passage (10)	—	- Free at all times.
		Dummy (50)	F02	- Always free wheeling.
		Classroom (55)	F05/F08	- Free at all times, except when locked by key.
		Nightlatch (57)	F03	- Entrance by trim when latchbolt is retracted by key. Key removable only when locked.
ED6600	—	Latch hold back	—	- Latchbolt held in retracted position by pushing in latchbolt and turning key.

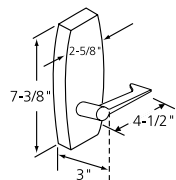
Device with Trim

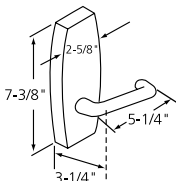
Pull Trim Design			Trim/Function				
			Passage	Dummy ANSI No. F02	Classroom ANSI No. F05/F08	Nightlatch ANSI No. F03	
	Armstrong A4M Lever: Cast Escutcheon: Cast Cylinder: 1-3/4" Mortise A02 Cam			A4M10	A4M50	A4M55	A4M57
	Citation C3M Lever: Cast Escutcheon: Cast Cylinder: 1-3/4" Mortise A02 Cam			C3M10	C3M50	C3M55	C3M57

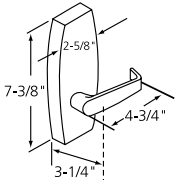
Mortise Trims and Functions

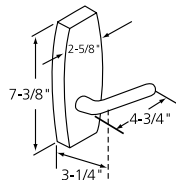
ED6000

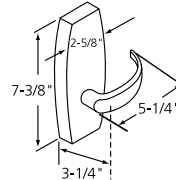
Pull Trim Design				Trim/Function			
				Passage	Dummy ANSI No. F02	Classroom ANSI No. F05/F08	Nightlatch ANSI No. F03
	<p>Dirke D3M</p> <p>Lever: Cast Escutcheon: Cast Cylinder: 1-3/4" Mortise A02 Cam</p> 		D3M10	D3M50	D3M55	D3M57	
	<p>Essex E3M</p> <p>Lever: Cast Escutcheon: Cast Cylinder: 1-3/4" Mortise A02 Cam</p> 		E3M10	E3M50	E3M55	E3M57	
	<p>Lustra L3M</p> <p>Lever: Cast Escutcheon: Cast Cylinder: 1-3/4" Mortise A02 Cam</p> 		L3M10	L3M50	L3M55	L3M57	
	<p>Newport N4M</p> <p>Lever: Cast Escutcheon: Cast Cylinder: 1-3/4" Mortise A02 Cam</p> 		N4M10	N4M50	N4M55	N4M57	
	<p>Regis R3M</p> <p>Lever: Cast Escutcheon: Cast Cylinder: 1-3/4" Mortise A02 Cam</p> 		R3M10	R3M50	R3M55	R3M57	
	<p>Princeton PR3M</p> <p>Lever: Cast Escutcheon: Cast Cylinder: 1-3/4" Mortise A02 Cam</p> 		PR3M10	PR3M50	PR3M55	PR3M57	



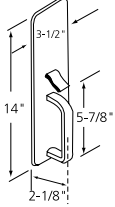
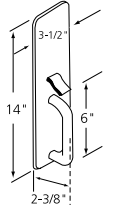
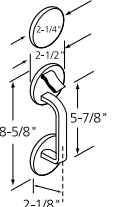
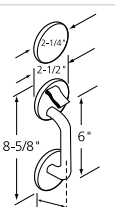

Mortise Trims and Functions

ED6000

Knob or Thumbpiece Trim Design	Trim/Function				
	Passage	Dummy ANSI No. F02	Classroom ANSI No. F05/F08	Nightlatch ANSI No. F03	
 <p>Belmont B4M Knob: Wrought reinforced Escutcheon: Cast Cylinder: 1-1/2" Mortise A02 Cam</p>		B4M10	B4M50	B4M55	B4M57
 <p>Global G5M Knob: Wrought reinforced Escutcheon: Cast Cylinder: 1-1/2" Mortise A02 Cam</p>		G5M10	G5M50	G5M55	G5M57
 <p>D Grip T7M Grip: Extruded Escutcheon: Wrought Cylinder: 1-1/4" Mortise A02 Cam</p>		T7M10	T7M50	T7M55	T7M57
 <p>Round Grip T8M Grip: Extruded Escutcheon: Wrought Cylinder: 1-1/4" Mortise A02 Cam</p>		T8M10	T8M50	T8M55	T8M57
 <p>D Grip Sectional T9M Grip: Extruded Cylinder: 1-1/4" Mortise A02 Cam</p>		T9M10	T9M50	T9M55	T9M57
 <p>Round Grip Sectional T10M Grip: Extruded Cylinder: 1-1/4" Mortise A02 Cam</p>		T10M10	T10M50	T10M55	T10M57

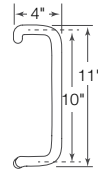
Offset Pull Trims

ED6000

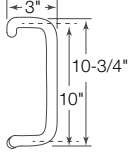
Offset Pull Trim: P12, P13, P14*			
	<p>Offset Pull P12 Clearance: 2-1/2 "</p>		<p>Specify Part Number, 716F50M x Finish¹</p>
	<p>Offset Pull P13 Clearance: 2-1/2 "</p>		<p>Specify Part Number, 716F51M x Finish¹</p>
	<p>Offset Pull P14 Clearance: 2-1/2 "</p>		<p>Specify Part Number, 716F52M x Finish¹</p>

1. Available in 605, 606, 612, 613, 626, 629 and 630 finishes.
*Available on 1-3/4" thick doors only.

Concealed Vertical Rod Exit Features

ED6000

ED6800 Panic-Listed Concealed Vertical Rod Exit Device



ED6800A 3-Hour Fire-Listed Concealed Vertical Rod Exit Device

For use with metal doors only.

Features

Handing

Field reversible; specify hand.

Bar length

Easily field cut to size.

Standard 36" bar fits doors up to 36" (914mm).

Optional 48" bar fits up to 48" (1219mm) doors; specify W048.

Door Thickness

1-3/4" (44mm) only (properly reinforced doors).

Backset

2-3/4" (70mm).

Stile

Minimum width 4-1/8" (108mm).

Door Height

All top rods easily field cut to size.

Standard on ED6800 devices: top rod for doors up to 8'6" .

Optional on ED6800 devices: top rod for doors up to 10' x 8"; see Quick Codes, page 36.

Standard on ED6800A devices: top rod for 7'2" door.

Projection

5-3/4" (150mm); 4-1/2" (114mm) depressed.

Latchbolts

Top: 3/4" (19mm) pivoted and deadlocking.

Bottom: 13/16" (20mm) throw rounded steel.

Rods

Top: 3/8" (10mm) solid steel.

Bottom: 1/2" (13mm) O.D. steel tubing.

Materials

Brass, bronze or stainless steel.

Cases

Heavy wrought, 7-1/4" x 2-9/16" (184mm x 65mm)

Crossbar

Standard: 13/16" x 1-3/8" (20mm x 35mm) oval seamless tubing.

Optional: reinforced crossbar or stainless steel crossbar; see Quick Codes, page 36.

Dogging

Standard on ED6800 devices.

Optional on ED6800 devices: less dogging, specify M51.

Dogging not available on ED6800A devices.

Fasteners

Standard on ED6800 devices: machine screws.

Optional on ED6800 devices: sex nuts and bolts; specify M54.

Optional on ED6800 and ED6800A devices: spanner head screws; specify M02.

Strikes

See Options and Accessories, page 31.

Trims and Functions

Through-bolted knob and operator trims available with wide range of functions. See Trims and Functions, page 26.

Cylinders

Cylinder not included unless specified. See How to Order, page 34.

Applications and Listings

See page 3.

Warranty

One-year limited.

Certification/Compliance

ANSI

Meets A156.3, Grade 1.

Meets A117.1 Accessibility Code.

C-UL US

All exit devices listed for safety as panic hardware; devices comply with UL 305 standards for panic hardware. 3-hour fire-rated devices listed as fire exit hardware for A label and less class 8' x 7'2" double doors. UL symbol on active head indicates listing.

Any retrofit or other field modification to a fire-rated opening can potentially impact the fire rating of the opening, and Corbin Russwin, Inc. makes no representations or warranties concerning what such impact may be in any specific situation. When retrofitting any portion of an existing fire-rated opening, or specifying

and installing a new fire-rated opening, please consult with a code specialist or local code official (Authority Having Jurisdiction) to ensure compliance with all applicable codes and ratings.

NFPA

All exit devices comply with NFPA 101 Life Safety Code. Fire-rated devices comply with NFPA 80 Fire Doors and Windows.

ADA

Exit devices, lever trims and pulls comply with Americans with Disabilities Act.

Finishes

BHMA 605	Bright Brass
BHMA 606	Satin Brass
BHMA 611	Bright Bronze
BHMA 612	Satin Bronze
BHMA 613	Oxidized Bronze, oil rubbed, available lacquered
BHMA 618	Bright Nickel Plated
BHMA 619	Satin Nickel Plated
BHMA 622	Flat Black Coated
BHMA 625	Bright Chromium Plated
BHMA 626	Satin Chromium Plated
626C	Satin Chromium Plated with MicroShield®
BHMA 629	Bright Stainless Steel
BHMA 630	Satin Stainless Steel
630C	Satin Stainless Steel with MicroShield®
BHMA 722	Black oxidized bronze, oil rubbed

Concealed Vertical Rod Exit Features

ED6000

ED6800 and ED6800A Concealed Vertical Rod Exit Devices



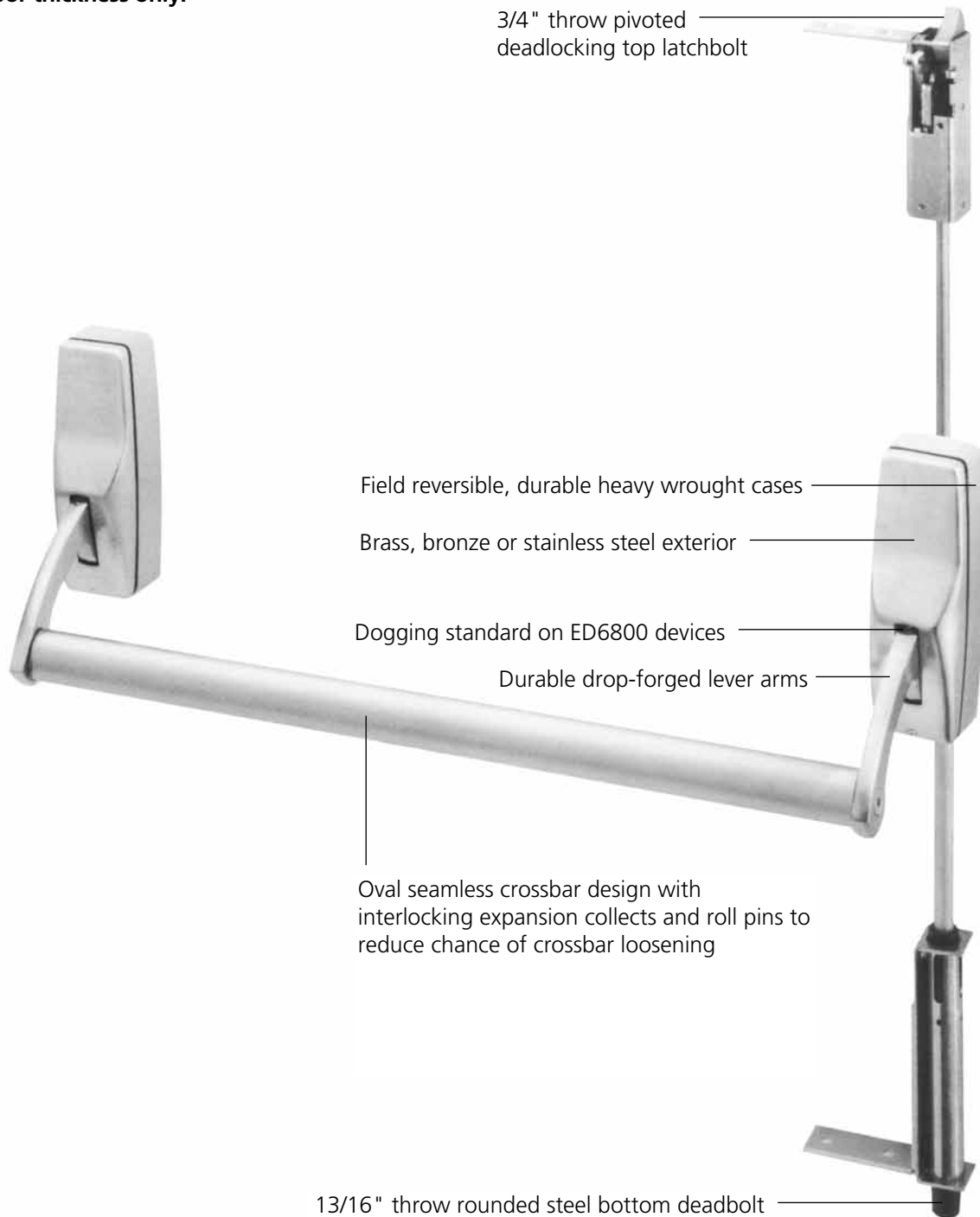



For use with metal doors only.
1-3/4" door thickness only.

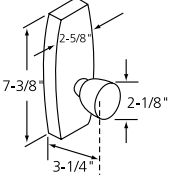

CVR Trims and Functions

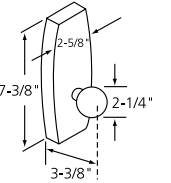
ED6000

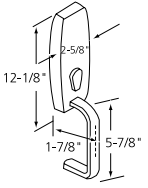
Concealed Vertical Rod Exit Device	ANSI Type	Accepts Trim/Function		Function Description (See Trim Designs Below)
		Type	ANSI No.	
ED6800	8	Exit Only	F01	- Exit only; no trim. (Accepts all trims listed below.)
ED6800A	8	Exit Only	F01	- 3-hour fire-rated exit only; no trim. (Accepts all trims listed below.)
For Passage, Dummy, Classroom and Nightlatch functions, see Trim Designs below.		Passage (10)	—	- Free at all times.
		Dummy (50)	F02	- Always free wheeling.
		Classroom (55)	F08/F11	- Free at all times, except when locked by key.
		Nightlatch (57)	F03/F04/ F09/F12	- Always rigid. Entrance by trim when latchbolt is retracted by key. Key removable only when locked.
ED6800	8	Latch hold back	F04	- Latchbolt held in retracted position by depressing bar and turning key. (Outside Cylinder Dogging.)

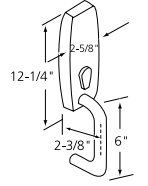
Pull Trim Design	Trim/Function			
	Passage	Dummy ANSI No. F02	Classroom ANSI No. F08/F11	Nightlatch ANSI No. F03/F04/ F09/F12
 <p>Belmont B5 Knob: Wrought reinforced Escutcheon: Cast Cylinder: 1-1/2" Mortise A02 Cam</p> 	B510	B550	B555	B557
 <p>Global G6 Knob: Wrought reinforced Escutcheon: Cast Cylinder: 1-1/2" Mortise A02 Cam</p> 	G610	G650	G655	G657
 <p>D Grip Operator 01 Grip: Extruded Escutcheon: Cast Cylinder: Mortise with A92 cam</p> 	N/A	0150	0155	0157 0156*
 <p>Round Grip Operator 02 Grip: Extruded Escutcheon: Cast Cylinder: Mortise with A92 cam</p> 	N/A	0250	0255	0257 0256*

*Key also holds top and bottom latchbolts in retracted position for ANSI No. 04 function. Not available with ED6800A devices.

ED66900 Series Electrically Controlled Mortise Exit Devices

Applications

This series offers the safety features of a heavy-duty mortise crossbar exit devices with the added security of an electrically controlled exit (ECE). Solenoid-operated units are designed for optimum versatility and flexibility, providing both power lock (fail safe) and power unlock (fail secure) functions in AC as well as DE systems. This devices is best used in:

- Stair tower doors
- Perimeter doors
- Security areas
- Computer areas
- Controlled environments

Advantages

- Proven reliability and durability of the Corbin Russwin Mortise Lockset
- Available as fail safe or fail secure
- Key always retracts latchbolt
- Integral solenoid
- Low voltage AC or DC systems available
- Accepts wide range of trims

ElectroLynx®

ElectroLynx, a new quick-connect feature of ASSA ABLOY Group companies, takes the guesswork out of installing electrified door hardware products.

It's ... hardwiring Made Easy. By using standard "plug and play" connectors, a simple "click" links power from the incoming source to electrified locking products, including hinges, locks, exit devices, magnetic holders, and strikes. What normally takes an hour or more can be connected in virtually minutes.

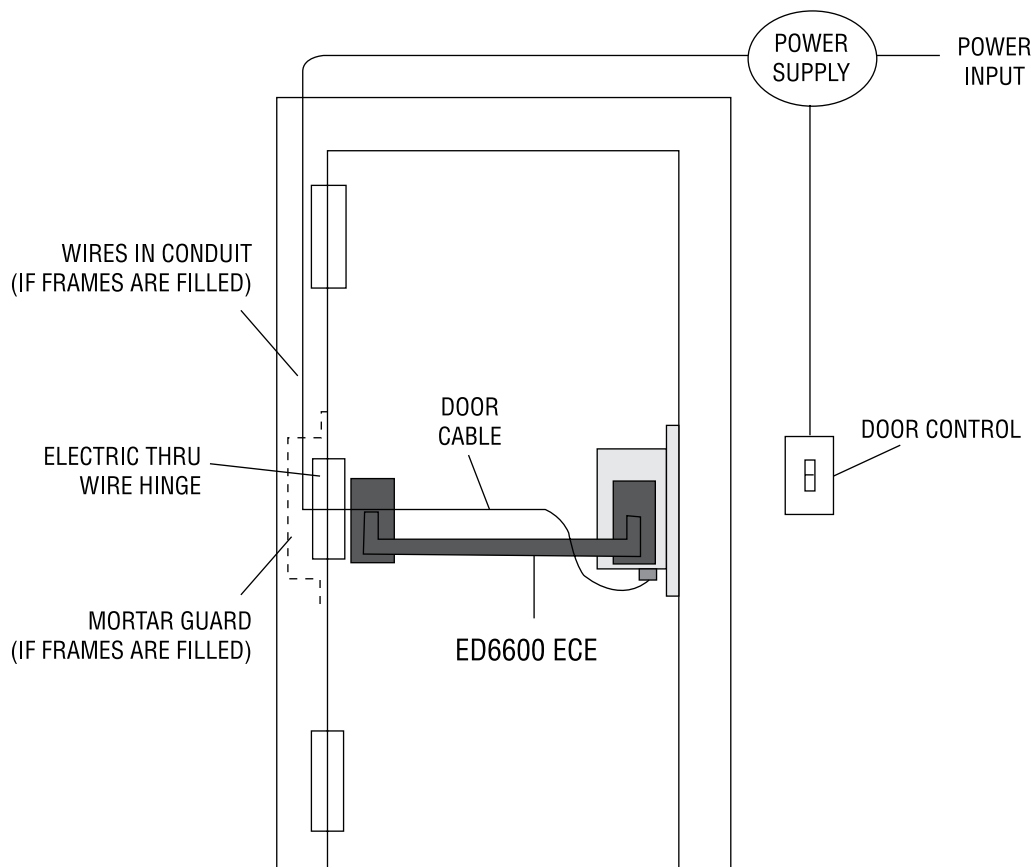

ECE Features

ED6000

ED66900 Panic-Listed ECE Mortise Exit Device

Features

Handing

Field reversible device; specify hand.
Mortise lock and strike are not reversible.

Bar Length

Easily field cut to size.
Standard 36" bar fits doors up to 36" (914mm).
Optional 48" bar fits doors up to 48" (1219mm); specify W048.

Door Thickness

1-3/4" (44mm).
Optional: 2" (51mm) and 2-1/4" (57mm); to order specify D200 or D214.

Backset

2-3/4" (70mm).

Stile

Minimum width: 5" (127mm).

Latchbolt

Brass, 3/4" (19mm) throw.

Auxiliary Latch

Brass.

Front

8" x 1-1/4" (203mm x 32mm) heavy gauge steel.
Accommodates flat doors and doors beveled 1/8" to 2" (3mm to 51mm).

Materials

Brass, bronze or stainless steel.

Cases

Heavy wrought, 7-1/4" x 2-9/16" (184mm x 65mm).

Crossbar

Standard: 13/16" x 1-3/8" (20mm x 35mm) oval seamless tubing.
Optional: reinforced crossbar or stainless steel crossbar; see Quick Codes, page 36.

Dogging

Dogging standard.
Optional: less dogging. Specify M51.

Fasteners

Standard: machine screws.
Optional: sex nuts and bolts; specify M54.
Optional: spanner head screws; specify M02.

Strike

Standard: ANSI strike.
Optional: open back strike and ANSI wrought strike box available; see Options and Accessories, page 32.

Trim

Accepts trims listed on pages 20-22.

Cylinders

Cylinder not included unless specified. See How to Order, page 34.

Operating Current

12VAC	0.8 AMPS
12VDC	0.8 AMPS
24VAC	0.4 AMPS
24VDC	0.4 AMPS

See How to Order, page 35.

Warranty

One-year limited.

Certification/Compliance

ANSI

Meets A156.3, Grade 1.

C-UL US

All exit devices listed for safety as panic hardware; devices comply with UL 305 standards for panic hardware. UL symbol on active head indicates listing.

NFPA

All exit devices comply with NFPA 101 Life Safety Code.

ADA

Exit devices, lever trims and pulls comply with Americans with Disabilities Act.

Finishes

BHMA 605	Bright Brass
BHMA 606	Satin Brass
BHMA 611	Bright Bronze
BHMA 612	Satin Bronze
BHMA 613	Oxidized Bronze, oil rubbed, available lacquered
BHMA 618	Bright Nickel Plated
BHMA 619	Satin Nickel Plated
BHMA 622	Flat Black Coated
BHMA 625	Bright Chromium Plated
BHMA 626	Satin Chromium Plated
626C	Satin Chromium Plated with MicroShield®
BHMA 629	Bright Stainless Steel
BHMA 630	Satin Stainless Steel
630C	Satin Stainless Steel with MicroShield®
BHMA 722	Black oxidized bronze, oil rubbed

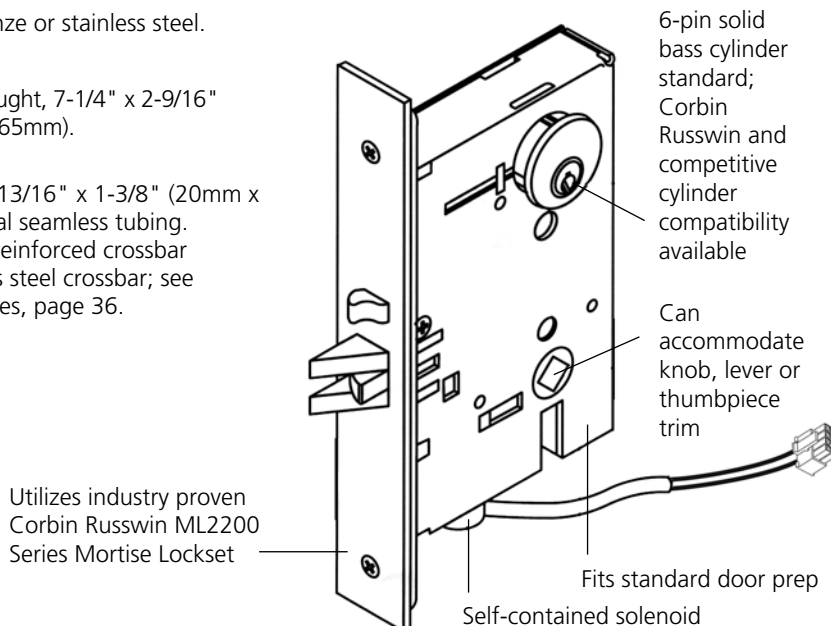

The following functions are locked when power is on (Fail Safe).

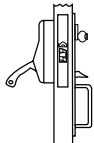
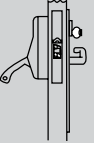
Inside	Outside	Function	Function Description
		ED66902	<ul style="list-style-type: none"> - When energized, solenoid locks outside trim; thumbpiece is then free-acting and disengaged. - Key retracts latchbolt at all times. - Mortise Lock No. MLE10.
		ED66904	<ul style="list-style-type: none"> - When energized, solenoid locks outside trim; knob or lever is then free-acting and disengaged. - Key retracts latchbolt at all times. - Mortise Lock No. MLE10.

The following functions are unlocked when power is on (Fail Secure).

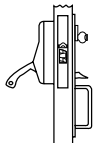
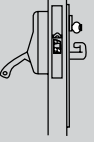
Inside	Outside	Function	Function Description
		ED66901	<ul style="list-style-type: none"> - When energized, solenoid unlocks outside trim. - Thumbpiece retracts latchbolt. - Key retracts latchbolt at all times. - Mortise Lock No. MLE11.
		ED66903	<ul style="list-style-type: none"> - When energized, solenoid unlocks outside trim. - Knob or lever retracts latchbolt. - Key retracts latchbolt at all times. - Mortise Lock No. MLE11.

Options and Accessories

ED6000

Rim Strikes

(Screws Included)

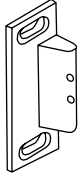

Rim Strike

Standard on ED6200 devices. For doors with 1/2" (13mm) or 5/8" (16mm) stop. Adjustable to compensate for shrinkage and swelling of door. Nylon anti-friction inserts for quieter operation. 3-1/4" x 1-1/16" (82mm x 27mm). To order separately, specify 145F55. 1/8" (3mm) shim available for 1/2" (13mm) stop; specify 184F82.

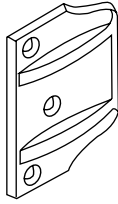

Rim x Vertical Rod Strike

Required for ED6200 devices when used with ED6400 device on a pair of doors. To order with device, specify option S02. To order separately, specify 467F73.

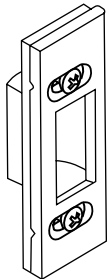

Mortised Adjustable Rim Strike

Optional for ED6200 devices only. Adjustable to compensate for shrinkage and swelling of door. 3-3/4" x 1-9/16" (95mm x 40mm). To order with device, specify option S04. To order separately specify 142F43.

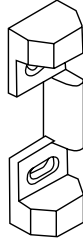

Fire-Rated Rim Strike

Standard on ED6200A devices. Steel with black nylon coating. Surface application; reversible, adjustable. 4-3/8" x 1-9/32" (111mm x 32mm). To order separately, specify 499F59.

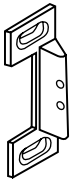

Open Rim Strike

Optional for ED6200 devices. Adjustable to compensate for shrinkage and swelling of door. Nylon anti-friction inserts for quieter operation. 3-1/4" x 1-3/32" (82mm x 28mm). To order with device, specify S05. To order separately, specify 145F56.

Vertical Rod Strikes

(Screws Included)

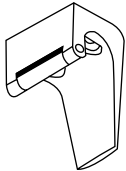

Top Strike for Latch Hold-Back

Standard on ED6400 devices with latch hold-back. 2-3/32" x 1-3/4" x 2-5/32" (53mm x 44mm x 55mm) high. To order separately, specify 392F24.

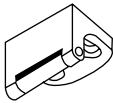

Non-Hold-Back Top Strike

Standard on ED6400 devices without latch hold-back. 1-1/2" x 1-3/4" x 7/8" (38mm x 44mm x 22mm) high. To order separately, specify 392F22.

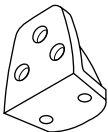

Flush Transom Strike Bracket

Optional for ED6400 devices when mounting top strike on flush transom. To order with device, specify option M67. To order separately, specify 176F65.

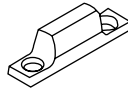

Surface Projecting Bottom Strike

Standard on ED6400 devices. 2-9/16" x 19/32" x 5/8" (65mm x 15mm x 16mm) high. To order separately, specify 502F96.

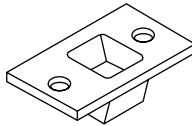

Flush Bottom Strike

Optional for ED6400 devices. 3-1/2" x 1-3/4" x 7/8" (99mm x 44mm x 22mm) deep. To order with devices, specify option S03. To order separately, specify 392F28.

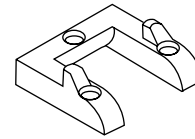

Bottom Strike for Threshold

Optional on ED6400A devices. For use with threshold. To order with device, specify option S06. To order separately, specify 304F34.

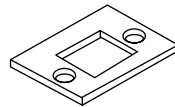

Bottom Strike

Standard on ED6400A devices. To order separately, specify 502F75.

Concealed Vertical Rod Strikes

(Screws Included)

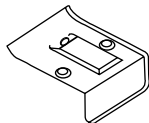

Top Strike

Standard on ED6800 devices. To order separately, specify 503F55.

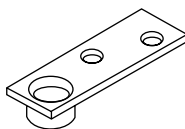

Bottom Strike

Standard on ED6800 and ED6800A devices. To order separately, specify 503F52.

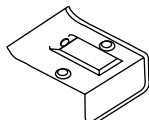

Fire-Rated Top Strike

Standard on ED6800A devices. To order separately, specify 503F56.

Options and Accessories

ED6000

Mortise Strikes

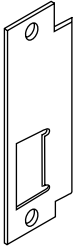

Straight Lip ANSI Strike

Standard on ED6600 and ED6600A. On stainless steel exit devices, stainless steel strike furnished standard. 4-7/8" x 1-1/4" x 1-1/8" (124mm x 32mm x 28mm) lip to center, for 1-3/4" (44mm) doors. To order separately, specify Part No.

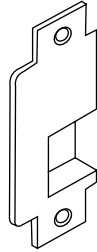

Open Back Strike

Optional for use with ED6400 x ED6600 devices on a pair of doors. See How to Order, page 35. To order separately, specify Part No. x Door Thickness x Finish.

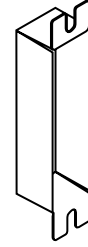

ANSI Wrought Strike Box



Optional for use with Mortise Strike on ED6600 and ED6600A devices; specify option M17. To order separately, specify 120F76-8.

Hand	Part No.
RHR	405L14
	240L51 (stainless steel)
LHR	405L13
	240L50 (stainless steel)

Hand	Door Thickness	Part No.
LHR	1-3/4"	411L62 016 FIN
	2"	411L62 018 FIN
	2-1/4"	411L62 020 FIN
RHR	1-3/4"	411L63 016 FIN
	2"	411L63 018 FIN
	2-1/4"	411L63 020 FIN

Filler Plates

Optional for use on stock metal doors when required. To order, specify Part No. x Finish.

		
Front 334F99-8 600	Strike 236L708018	Front 077F19-8 600

500 Series and 900 Series Removable Mullions

The 500 series and 900 series mullions are used to install two ED7200 Rim Exit Devices in a double door opening. They may be quickly and easily removed, then reinstalled, when a full double door opening is temporarily required. The 500 series and 900 series mullions meet ANSI A156.3, Type 22.

Materials and Finish

Steel mullion with malleable iron top and bottom plates; furnished with zinc plated fasteners for metal frames and concrete floors. May be cut, drilled and tapped in the field for Rim Exit Devices. The 500 series mullions are primed for painting, BHMA 600, grey and the 900 series mullions are primed for painting, BHMA 600, red.

500 Series Mullions - How to Order Removable Mullions

UL Fire Rating ¹	Mullion Opening Height ²	Catalog Number
3-Hour	Up to 7'2"	507
Panic Only	Up to 8'0"	508
Panic Only	Up to 10'0"	510

Notes:

1. UL label on mullion indicates listing.
2. May be field cut for doors.

900 Series Mullions - How to Order Removable Mullions

UL Fire Rating ¹	Mullion Opening Height ²	Catalog Number
Panic Only	Up to 7'0"	907
Panic Only	Up to 8'0"	908
Panic Only	Up to 10'0"	910
3-Hour	Up to 7'0"	907A
3-Hour	Up to 8'0"	908A

Key Removable Mullions

UL Fire Rating ¹	Mullion Opening Height ²	Catalog Number
1-1/2 Hour	Up to 7'0"	907BKM ³
1-1/2 Hour	Up to 8'0"	908BKM ³
Panic Only	Up to 10'0"	910KM ³

Notes:

1. UL label on mullion indicates listing.
2. May be field cut for doors.
3. Cylinder and collars not included, specify separately. See Cylinders on page 34.

500 Mullion

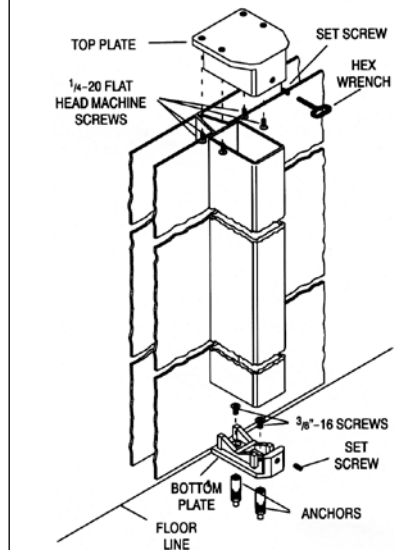

900 Series Mullions - Options M95- Spacer Block

Recommended for double rabbeted frames where the stop face width is less than the mounting hole spacing and also for door frames 5-3/4" (176mm) or less. To order with a mullion, specify M95. To order separately, specify Part No. 683F29-8.

M96- Angle Bracket

Recommended for any header configuration with less than 3" (76mm) of mounting surface. To order with a mullion, specify M96. To order separately, specify Part No. 655F63-8.

M57- Mullion Stabilizer Kit

Controls the movement of the mullion. Recommended for opening over 7' high, or whenever door movement must be minimized. To order with mullion, specify M57. To order separately, specify Part No. 653F11-1 x 695 or 628.

900 Mullion

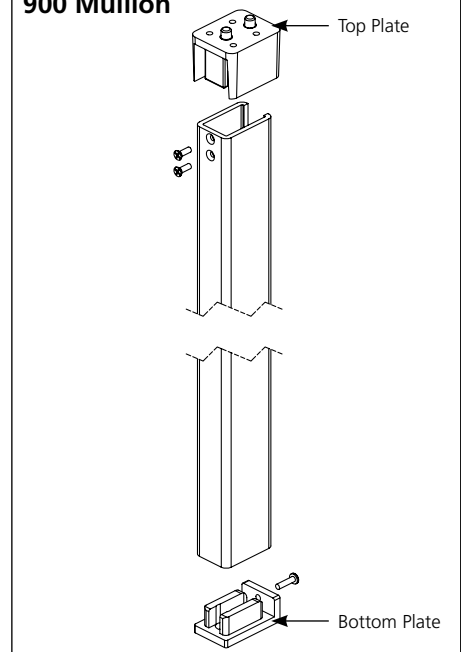

Cylinders

ED6000

Cylinders

- L4 keyway standard; specify other keyways.
- Specify Collar.
- To order with Exit Device, see How to Order, page 35.

- To order separately, specify Part No. x Keyways Finish (e.g., 3000-200 x L4 x 626).

Cylinder Type	Part No.	Description
Rim	3000-200	6-pin, horizontal tailpiece
	3000-200-7	7-pin, horizontal tailpiece
	3010-200	6-pin, horizontal tailpiece, Security
	3012-178	6-pin, blockout function, Security
	3020-200	7-pin, Pyramid High Security
	3027-200	7-pin Pyramid Security
	3027-178	7-pin Pyramid IC Security
	3030-178	7-pin, Pyramid IC High Security
	3040-178	6-pin SFIC Rim Housing
	3040-178-7	7-pin SFIC Rim Housing
	3060-200	6-pin, master ring
	3070-178	6-pin, interchangeable core (IC) less core
	3070-178-7	7-pin, IC less core
	3080-178	6-pin, IC
	3080-178-7	7-pin, IC
	3090-178	6-pin, Security IC
	1000-112-A02	6-pin, 1-1/2" straight cam
	1000-112-A02-7	7-pin, 1-1/2" straight cam
	1000-114-A02-7	7-pin, 1-1/4" straight cam
	1000-114-A92-7	7-pin, 1-1/4" (O1 and O2 trims only)
	1000-118-A02	6-pin, 1-1/8" straight cam
	1000-118-A92	6-pin, 1-1/8" (O1 and O2 trims only)
	1000-134-A02	6-pin, 1-3/4" straight cam
	1000-134-A02-7	7-pin, 1-3/4" straight cam
	1010-112-A02	6-pin, 1-1/2" Security straight cam
1010-118-A02	6-pin, 1-1/8" Security, straight cam	
1010-118-A92	6-pin, 1-1/8" Security (O1 and O2 trims only)	
1010-134-A02	6-pin, 1-3/4" Security straight cam	
1012-114-A02	6-pin, 1-1/4" Security with blockout	
1012-114-A92	6-pin, 1-1/4" Security blockout (O1 and O2 trims only)	
1020-112-A02	7-pin, Pyramid High Security 1-1/2"	
1020-114-A02	7-pin, Pyramid High Security 1-1/4"	
1027-112-A02	7-pin, Pyramid Security IC 1-1/2"	
1027-114-A02	7-pin, Pyramid Security 1-1/4"	
1030-114-A02	7-pin, Pyramid IC High Security 1-1/4"	
1037-114-A02	7-pin, Pyramid Security IC 1-1/4"	
1040-112	7-pin, 1-1/2" SFIC Mortise Housing	
1040-114	6-pin, 1-1/4" SFIC Mortise Housing	
1040-134	7-pin 1-3/4" SFIC Mortise Housing	
1040-138	7-pin, 1-3/8" SFIC Mortise Housing	
1070-114-A02	6-pin, 1-1/4" IC less core	
1080-112-A02	6-pin, 1-1/2" IC straight cam	
1080-112-A02-7	7-pin, 1-1/2" IC straight cam	
1080-114-A02	6-pin, 1-1/4" IC straight cam	
1080-134-A02	6-pin, 1-3/4" IC straight cam	
1080-134-A02-7	7-pin, 1-3/4" IC straight cam	
1090-112-A02	6-pin, 1-1/2" IC Security straight cam	
1090-114-A02	6-pin, 1-1/4" IC Security straight cam	
1090-134-A02	6-pin, 1-3/4" IC Security straight cam	
1000-118-A62	6-Pin	
1000-114-A62-7	7-Pin	
1080-114-A62	6-Pin, IC	
1080-112-A62-7	7-Pin, IC	
1020-114-A62	7-pin, Pyramid High Security	
1027-114-A62	7-pin, Pyramid Security	
1030-114-A62	7-pin, Pyramid High Security IC	
1037-114-A62	7-pin, Pyramid Security IC	
1010-118-A62	Security	
1090-114-A62	Security IC	
1070-114-A62	6-pin, IC, less core	
1070-112-A62-7	7-pin, IC, less core	

900 Series Key Removable Mullion Mortise Cylinders

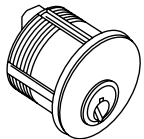

900 Series Key Removable Mullion Cylinder Collar Packet

Mullion Series	Cylinder Length and Type			
	1-1/8"	1-1/4"	1-1/4" IC	1-1/2" IC
907BKM	610F01*	447F43*	609F37*	
908BKM				
910KM				

Note: Cylinder collar packets contain a collar and spring washer. *Specify finish when ordering packets.

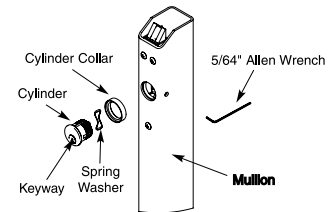

Rim Exit Device

Quantity	Exit Device	Finish	Hand	Misc. Options
27	ED6200	630	RHR	M51-M54

Removable Mullion

Quantity	Mullion
9	507

Trim Only (For Rim Exit Device)

Quantity	Trim/Function	Finish	Hand	Door Thickness
34	L210	625	RHR	D214

Where to find ordering information and Quick Codes

Functions and Trims	Pages
Rim and Vertical Rod	Pages 9-12
Fire-Rated Rim	Pages 15-17
Mortise	Pages 20-23
Concealed Vertical Rod	Page 26
Removable Mullion	Page 33
Cylinder and Keying	Page 36
Miscellaneous Options	Page 36
Finish	Page 37
Handing	Page 37
Door Thickness	Page 37
Strike	Page 37
Door Width	Page 37
Door Height	Page 37

Rim Exit Device with Trim

Quantity	Exit Device	Trim/Function	Finish	Hand	Door Thickness	Optional Strike	Door Width	Misc. Options
18	ED6200	N355	605	LHR	D200	S04	W048	M53

Contract/Detailed Order - Rim Exit Device with Trim

Quantity	Keypad	Exit Device	Trim/Function	Finish	Hand	Door Thickness	Door Width	Door Options	Misc. Options	Cylinder Keying	Keyway
68	AA1	ED6200	C255	626	RHR	D200	W048	M50-M54	7P	VKC3	59A1

Ordering Examples - ED66900 Series

Lock Only (Includes lock case, armored front, strike and screw pack)

Quantity	Mortise Lock	Finish	Hand	Voltage
16	MLE10	626	LHR	24D

Handing

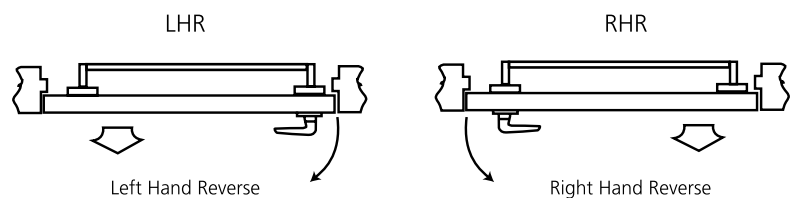

Note: Arrow indicates secure side of door.

Contract/Detailed Order

Quantity	Keypad	Exit Device	Trim/Function	Finish	Hand	Voltage	Options	Misc. Options	Cylinder Keying	Keyway
34	AA1	ED66904	C3M55	626	RHR	12A	M53-M54	6P	VKC3	59A1

Quick Codes

ED6000

Cylinder and Keying

Description	Specify
Conventional 6-pin	6P
Conventional 7-pin	7P
Pyramid Security fixed core ⁴	PS
Pyramid Security IC ¹	PCS
Pyramid High Security fixed core ⁴	PHS
Pyramid High Security IC ¹	PCHS
Pyramid IC with temporary construction core ¹	CTP
Pyramid IC with temporary disposable core ¹	CTPD
Pyramid IC less core ¹	CLP
Security	HS
Security IC ¹	CHS
Blockout function cylinder	BO
IC 6-pin ¹	C6
IC 6-pin with temporary construction core (Red) ¹	CT6R
IC 6-pin with temporary construction core (Blue) ¹	CT6B
IC 6-pin with temporary construction core (Green) ¹	CT6G
IC 6-pin with temporary construction core ¹	CT6
IC 6-pin with temporary disposable core ¹	CT6D
IC 6-pin less core ¹	CL6
SFIC 6-pin with Less Core	CLS6
SFIC 6-pin with SFIC disposable temporary core	CT6SD
IC 7-pin ^{1,2}	C7
IC 7-pin with temporary construction core (Red) ¹	CT7R
IC 7-pin with temporary construction core (Blue) ¹	CT7B
IC 7-pin with temporary construction core (Green) ¹	CT7G
IC 7-pin with temporary construction core ^{1,2}	CT7
SFIC 7-pin with Less Core	CLS7
SFIC 7-pin with SFIC disposable temporary core	CT7SD
IC 7-pin with temporary disposable core ^{1,2}	CT7D
IC 7-pin less core ^{1,2}	CL7
Less master ring cylinder ³	MR-LC
Master Ring ³	MR
0-bitted with 2 blank keys	(standard)
Keyed random	KR
Construction master keyed	CMK (not available for Pyramid)
No keying data stamped on key or cylinder	VKC0
Keys only	VKC1
Cylinders and keys (not for HS, CHS, PHS or PCHS)	VKC2
Cylinders only (not for HS, CHS, PHS or PCHS)	VKC3
Concealed key control (CKC)	
- CKC cylinders with VKC keys	CKC2
- CKC cylinders only (not for HS, CHS, PHS or PCHS)	CKC3
2 keys per lock	(standard)
More than 2 keys	KY# (e.g., KY6)

1. Not available on O1 and O2 trim.

2. Rim only.

3. Complete rim and vertical rod devices are available with master ring trim. However, complete master ring mortise devices are discontinued. Master ring mortise trim is available to support old master ring mortise devices in the field.

4. Not available in ED6600, A4M, C3M, D3M, E3M, L3M, N4M, PR3M, R3M, B4M, G5M trims.



Miscellaneous Options

Description	Specify
ANSI wrought strike box	M17
Knurling outside & inside (trim & device; not available with M50)	M20
Knurling outside only (trim side)	M21
Knurling inside only (device side; not available with M50)	M22
Abrasive coat outside and inside (trim and device)	M23
Abrasive coat inside only (device side)	M24
Abrasive coat outside only (trim side)	M25
Stainless steel crossbar (not available with M20 or M22)	M50
Less dogging	M51
Steel reinforced crossbar	M53
Sex nuts and bolts (SNBs)	M54
Mullion stabilizer kit	M57
Shim for 2-3/4" backset on doors with 1/2" stop (rim devices only)	M59
Freelatching latchbolts (ED6400 devices only)	M65
Flush transom bracket	M67

Strike

Description	Specify
Rim	
Mortised adjustable	S04
Open	S05
Rim x Vertical Rod	S02
Vertical Rod	
Flush bottom (ED6400 devices only)	S03
3-hour fire-rated bottom for use with threshold	S06
Mortise	
Open back strike	
1-3/4" door thickness	SB134
2" door thickness	SB200
2-1/4" door thickness	SB214
Straight Lip ANSI Strike	
1-3/4" door thickness	(standard)
2" door thickness	SS114
2-1/4" door thickness	SS138

Finish

Description	Specify
US3 Bright Brass	605
US4 Satin Brass	606
US9 Bright Bronze	611
US10 Satin Bronze	612
US10B Dark Oxidized Satin Bronze, oil rubbed	613
US14 Bright Nickel Plated	618
US15 Satin Nickel Plated	619
US19 Flat Black Coated	622
US26 Bright Chromium Plated	625
US26D Satin Chromium Plated	626
— Satin Chrome Plated with MicroShield® 	626C
US32 Bright Stainless Steel	629
US32D Satin Stainless Steel	630
— Satin Stainless Steel with MicroShield® 	630C
— Black oxidized bronze, oil rubbed	722

Door Height

Door	Specify
7'2" (ED6400A and ED6800A devices)	(standard)
7'6" (ED6400 devices)	(standard)
8'6" (ED6800 devices)	(standard)
10'0" (ED6400 devices only)	H1000
10'8" (ED6800 devices only)	H1008

Handing

Hand	Specify
Right Hand Reverse	RHR
Left Hand Reverse	LHR

Door Width

Door	Specify
36" (914mm)	(standard)
48" (1219mm)	W048

Door Thickness

Door	Specify
1-3/4" (44mm)	(standard)
2" (51mm) (except ED6800)	D200
2-1/4" (57mm) (except ED6800)	D214

Voltage

Door	Specify
12 volt alternating current	12A
12 volt direct current	12D
24 volt alternating current	24A
24 volt direct current	24D

Helpful Terms

ED6000

Abrasive Coat

Hard granular material applied to provide a non-slip tactile surface for the visually impaired.

Active Door

In a pair of doors, the door that is operable from the trim side.

Astragal

A vertical member applied to one or both sides of a pair of doors at the meeting edges. The astragal closes the gap between the two doors.

Coordinator

A device used on a pair of doors to ensure that the inactive door closes before the active door.

Deadlocking Latch

A supplemental latch that automatically deadlocks the latchbolt when pressure is applied to it.

Dogging

A mechanism that allows the latchbolt to remain retracted, permitting the door to operate as if it were a push-pull; it cannot be used on fire-rated exit devices.

Double Egress

A pair of doors of the same hand that swing in opposite directions, commonly found in corridors.

Dummy Trim

Trim only. Usually used on the inactive door of a pair of doors for design balance.

Exit Device (Panic Hardware)

A door locking device with a pushpad or crossbar which, when pressed, allows instant exit (egress).

Fire Exit Hardware

An exit device listed by an independent testing laboratory as meeting panic, fire and hose stream test standards; used on fire rated openings.

Hand

The direction a door swings.

Inactive Door

In a pair of doors, the door that is inoperable from the trim side.

Latchbolt

A lock component that has a beveled end and projects into a strike, holding the door in a closed position.

Mullion

A fixed or removable vertical member that divides a door opening and provides a latch surface for a pair of rim exit devices.

Narrow Stile Door

Usually a door having a stile of less than 2-3/4" wide, commonly seen on aluminum or glass front applications.

Open Back Strike

For mortise exit devices, used on the inactive door (usually the vertical rod door) of a pair of doors that swing in the same direction. It permits the inactive door to open or close independently.

Reversible

Pertains to a product that may be changed in the field to accommodate any hand of the door.

Shim Kit

Pieces of metal that permit mounting of an exit device on a door that has a surface projecting vision light (glass bead) molding.

Split Astragal

An astragal that is split through the middle on a pair of doors, allowing both doors to operate independently.

Threshold

A strip fastened to the floor beneath a door. It serves as a stop, prevents heat loss, and provides a strike location for latching the bottom rod of a vertical rod exit device.

Trim

A knob, lever, pull, or thumbpiece used on the outside of an exit device door to control access to an area.

Universal Exit Device

An exit device that may be used on doors of either hand without any modifications.

Keying and Cylinder Terms

Blockout Cylinder

A cylinder which allows all keys to be temporarily blocked from operating. It is set by a blockout key.

Concealed Key Control (CKC)

The marking of standard key symbols on a cylinder in a location that is not visible once the cylinder is installed.

Construction Master Keying (CMK)

A cylinder preparation that allows temporary access by construction personnel.

Control Key

A key used to remove and install interchangeable cores.

Cylinder

A lock component containing the combination that determines which keys will operate.

Security Cylinder

A cylinder which provides extra resistance to picking and unauthorized duplication of keys.

Interchangeable Core (IC)

A cylinder which can be removed and installed quickly with a control key by non-skilled personnel when rekeying is required.

Key Symbol

A letter/number combination in standard industry format (e.g., 1AA, AA1, etc.) which indicates exactly how a key or cylinder fits into a keying system.

Keyway

The opening in a cylinder plug through which the key enters.

Master Keying

Preparation of a cylinder to operate with keys of different levels of access.

Visual Key Control (VKC)

The marking of standard key symbols on keys and on the visible portion of the front of a cylinder.

Suggested Specification ED6000 Series

All exit devices shall be ED6000 Series Crossbar Exit Devices as manufactured by Corbin Russwin Architectural Hardware.

The maximum projection shall be 5-3/4", and 4-1/2" when crossbar is depressed. Exit devices shall have matched twin cases mounted with concealed fastening screws and shall be constructed of brass, bronze or stainless steel. Non-matched twin cases shall not be acceptable. Crossbar lever arms shall be drop forged. Devices shall be field reversible.

Crossbars shall be oval-shaped and shall be a minimum of .065" thick. Crossbars shall interlock into the lever arms by expansion collects and interlocking roll pins. Crossbars attached with rivets shall not be acceptable. Reinforced crossbars and stainless steel crossbars shall be available. All exit devices shall be easily field sized to accommodate various door widths.

Panic listed exit devices shall have dogging standard. Dogging screws shall seat into heat-treated pivots for long life and minimum wear. Panic listed devices shall be available less dogging.

All exit devices shall have ample allowances for easy alignment.

Trims shall be through-bolted with concealed fasteners. Escutcheon, rose and pull trims shall be constructed of brass, bronze or stainless steel. All lever trims shall use cast levers. Wrought levers shall not be acceptable. Lever trims shall match those on Corbin Russwin Mortise and Cylindrical Locksets.

All devices and trims shall be furnished in architectural finishes.

All devices shall be listed by Underwriters Laboratories (UL) for safety as panic hardware. Fire-rated devices shall be UL listed for A label and lesser class doors, 4' x 7'2" single and 8' x 7'2" pair.

Certification:
ANSI A156.3, Grade 1
ANSI A117.1 Accessibility Code
California State Fire Marshal pursuant to section 13144.1 of the California Health and Safety Code.

All devices, trims and cylinders shall be from one manufacturer.

All mechanical devices and trims shall carry a one-year limited warranty.

All electro-mechanical devices shall carry a two-year limited warranty.

Suggested Specification ED66900 Series

All exit devices shall be ED66900 Series Electrically Controlled Exit Devices, as manufactured by Corbin Russwin Architectural Hardware.

All mortise lock functions shall be available in one size case, manufactured from heavy-gauge steel, minimum thickness 3/32", completely chrome plated for corrosion resistance and lubricity of parts. Cases shall be closed on all sides to protect internal parts. Locks shall have adjustable, beveled and armored fronts, standard 2-3/4" backset, a full 3/4" throw two-piece mechanical anti-friction latchbolt, and shall be available for 1-3/4", 2" and 2-1/4" thick doors. Internal parts shall be heavy gauge steel, zinc dichromate plated for corrosion resistance.

Devices shall fit ANSI standard strike preparation. Other than for wiring, no special door or frame preparation shall be required.

Devices shall be available 12 or 24 volt, AC or DC, and fail safe or fail secure.

Mechanical cylinder override shall be available. Optional cylinders shall include interchangeable core, security and blockout types.

Lock trim (knob, lever or thumbpiece) shall be through-bolted through the lockcase to ensure correct alignment and proper operation.

Certification:
ANSI A156.3, Grade 1
ANSI A117.1 Accessibility Code (lever handle trim)
California State Fire Marshal pursuant to section 13144.1 of the California Health and Safety Code.

All devices, trims and cylinders shall be from one manufacturer.

All mechanical devices and trims shall carry a one-year limited warranty.

All electro-mechanical devices shall carry a two-year limited warranty.



ASSA ABLOY

In U.S.

Corbin Russwin
Architectural Hardware
225 Episcopal Road
Berlin, CT 06037
Phone: 800-543-3658
Fax: 800-447-6714
www.corbinruswin.com

In Canada

ASSA ABLOY Door
Security Solutions Canada
160 Four Valley Drive
Vaughan, Ontario
Canada L4K 4T9
Phone: 800-461-3007
Fax: 1-905-738-2478
www.assaabloy.ca

For more information regarding Corbin Russwin Locksets, Exit Devices, Door Controls and Key Systems, contact your authorized Corbin Russwin Distributor or Sales Representative.



MicroShield®

As part of their promise to provide innovative solutions to their customers, certain ASSA ABLOY Group brands offer the MicroShield® technology, a silver-based antimicrobial coating designed to inhibit the growth of bacteria. MicroShield® is a registered trademark of Yale Security Inc., an ASSA ABLOY Group company.

Hardwiring Made Easy™



ElectroLynx®

As part of their promise to provide innovative, fast and effective high security solutions to their customers, certain ASSA ABLOY Group brands offer ElectroLynx®, a universal quick-connect system that simplifies the electrification of the door opening. ElectroLynx® is a registered trademark of ASSA ABLOY Inc.

Corbin Russwin and Design® is a registered trademark of Corbin Russwin Inc., an ASSA ABLOY Group company. These materials are protected under US copyright laws. All contents current at time of publication. Corbin Russwin, Inc., an ASSA ABLOY Group company reserves the right to change availability of any item in this catalog, its design, construction, and/or its materials. Other products brand names may be trademarks or registered trademarks of their respective owners and are mentioned for reference purposes only. Copyright© 2003, 2012 Corbin Russwin Inc., an ASSA ABLOY Group company. All rights reserved. Reproduction in whole or in part without the express written permission of Corbin Russwin, Inc. is prohibited.

ASSA ABLOY is the global leader in door opening solutions, dedicated to satisfying end-user needs for security, safety and convenience.