

ML2000 Series

Mortise Lock Parts Manual
For Locks Made Prior to 2016

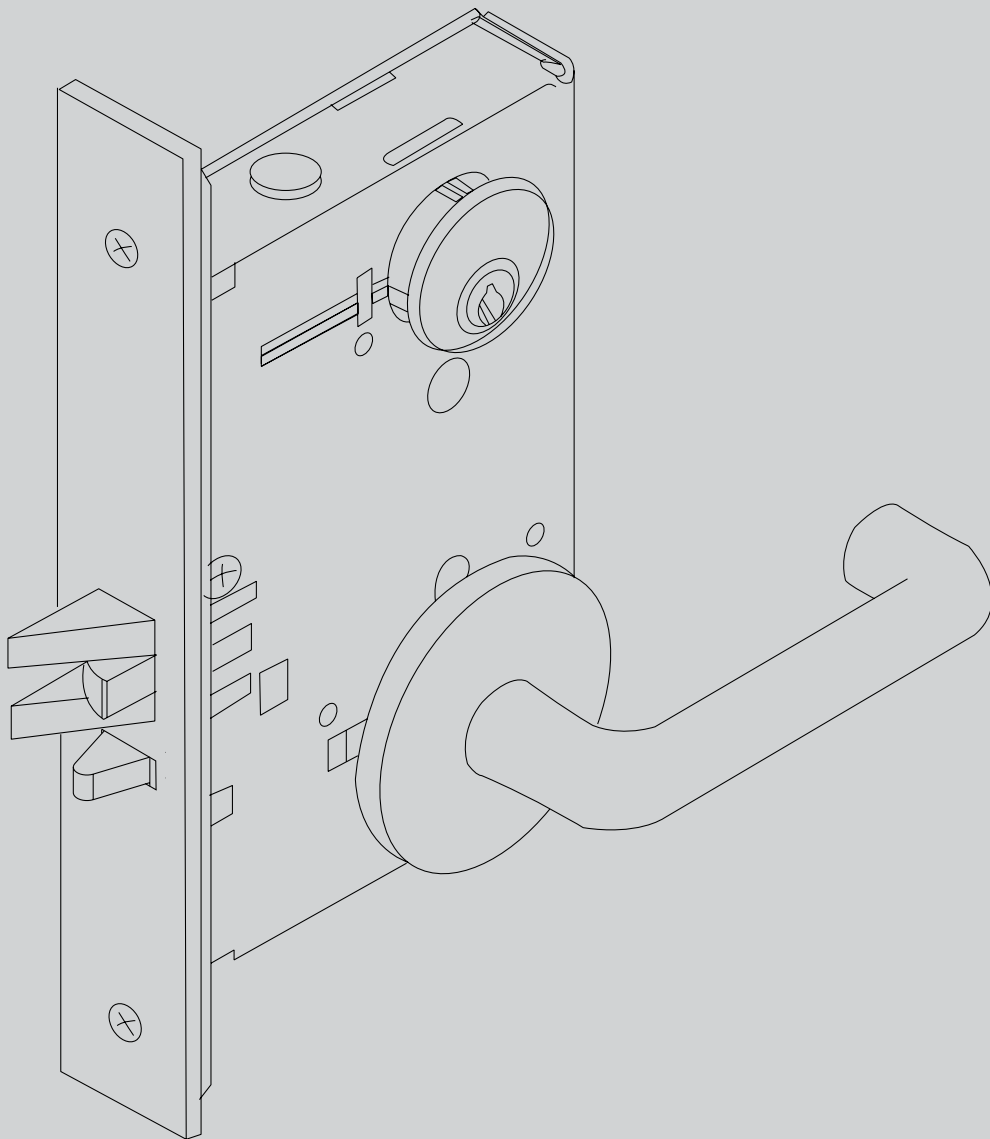

To order parts, use the appropriate Part Number and specify Finish (fin) as directed. For example, to order ten Toggle Levers for the ML2067 Function, use the following configuration:

Quantity	Part Number	Finish	Hand
10	461F01-2		

- In order to simplify the ordering procedure, parts are only available as listed.
- Refer to the installation instructions for complete installation.
- Limited warranty against defects in materials and workmanship under normal use and service. Corbin Russwin is not responsible for alterations or modifications made to our products by others. (See full limited warranty for further details.)
- For assistance, contact your authorized Corbin Russwin distributor or Corbin Russwin directly at the address on the back cover.

The warranty on Corbin Russwin products becomes void if the product is modified in any way, regardless of whether the modifications causes or contributes to any alleged defect. If a Corbin Russwin product is modified it may no longer meet industry certification and quality control standards applicable to the original product and is no longer a genuine Corbin Russwin product.

Copyright © 2000-2020, ASSA ABLOY Access and Egress Hardware Group, Inc. All rights reserved. Reproduction in whole or in part without the express written permission of ASSA ABLOY Access and Egress Hardware Group, Inc. is prohibited. Patent pending and/or patent www.assaabloydss.com/patents.

Lock Function Index	3
Deadlock Version Index.....	7
Deadlock Functions.....	8
Knob Version Index.....	12
FUNCTION DESCRIPTION	
Passage or Closet	15
Privacy, Bedroom or Bathroom (ANSI F02).....	17
Store Door.....	17
Entrance or Storeroom.....	17
Hotel or Motel.....	19
Privacy, Bedroom or Bathroom (ANSI F19).....	21
Dormitory, Entrance or Storeroom	21
Institution or Utility.....	23
Entrance or Public Restroom	25
Classroom	25
Entrance or Apartment.....	27
Entrance or Office	29
Storeroom or Closet	31
Privacy.....	33
Apartment or Dormitory.....	35
Institutional Privacy.....	37
Classroom Security	39
Lever Version Index	41
FUNCTION DESCRIPTION	
Passage or Closet	44
Privacy, Bedroom or Bathroom (ANSI F02).....	46
Store Door.....	46
Entrance or Storeroom.....	46
Hotel or Motel.....	48
Privacy, Bedroom or Bathroom (ANSI F19).....	50
Dormitory, Entrance or Storeroom	50
Institution or Utility.....	52
Entrance or Public Restroom	54
Classroom	54
Entrance or Apartment.....	56
Entrance or Office	58
Storeroom or Closet	60
Privacy.....	62
Apartment or Dormitory.....	64
Institutional Privacy.....	66
Classroom Security	68
Mortise Crossbar Exit Device Index	
DEVICE DESCRIPTION	
ED6600 Series	70
ED6600A Series.....	72
ED7600,ED7600A Series.....	74

The warranty on Corbin Russwin products becomes void if the product is modified in any way, regardless of whether the modifications causes or contributes to any alleged defect. If a Corbin Russwin product is modified it may no longer meet industry certification and quality control standards applicable to the original product and is no longer a genuine Corbin Russwin product.

Copyright © 2000-2020, ASSA ABLOY Access and Egress Hardware Group, Inc. All rights reserved. Reproduction in whole or in part without the express written permission of ASSA ABLOY Access and Egress Hardware Group, Inc. is prohibited. Patent pending and/or patent www.assaabloydss.com/patents.

Strikes.....76

Lock Case Assembly Parts - Master List.....77

Trim Components83

 DESCRIPTION

 Lever x Wrought Escutcheon.....83

 Wrought Knob x Wrought Escutcheon.....83

 Lever x Cast Escutcheon84

 Vandal Resistant Lever Trim.....84

 Cast Knob x Cast Escutcheon85

 Lever x Rose85

 Wrought Knob x Rose86

 Cast Knob x Rose86

 Half Trim - Lever x Escutcheon87

 Half Trim - Wrought Knob x Escutcheon87

 Half Trim - Cast Knob x Escutcheon87

 Half Trim - Lever x Rose.....88

 Half Trim - Wrought Knob x Rose.....88

 HalfTrim - Cast Knob x Rose.....88

Inside Levers & Outside Lever & Spindle Assemblies.....89

Inside Knobs & Outside Knob & Spindle Assemblies93

Escutcheons.....95

Rose & Thimble Packets102

Adapter Packets.....103

Spindle Component Parts.....107

Spindles107

Screws & Screw Packets108

Miscellaneous Parts.....109

Cylinders110

Cylinder Collars.....111

ML2000 Hand Reversing Instructions116

The warranty on Corbin Russwin products becomes void if the product is modified in any way, regardless of whether the modifications causes or contributes to any alleged defect. If a Corbin Russwin product is modified it may no longer meet industry certification and quality control standards applicable to the original product and is no longer a genuine Corbin Russwin product.

Copyright © 2000-2020, ASSA ABLOY Access and Egress Hardware Group, Inc. All rights reserved. Reproduction in whole or in part without the express written permission of ASSA ABLOY Access and Egress Hardware Group, Inc. is prohibited. Patent pending and/or patent www.assaabloydss.com/patents.



Deadlock Functions

ML2011	8
ML2012	8
ML2013,ML2013HS	8
ML2017	10

Lockset Functions	Knob	Lever
ML2010,ML2010HS,ML2010VR	15	44
ML2020,ML2020HS,ML2020VR	17	46
ML2022,ML2022HS,ML2022VR	17	46
ML2024,ML2024HS,ML2024VR	17	46
ML2029,ML2029HS,ML2029VR	19	48
ML2030,ML2030HS,ML2030VR	21	50
ML2032,ML2032HS,ML2032VR	23	52
ML2042,ML2042HS,ML2042VR	25	54
ML2048,ML2048HS,ML2048VR	27	56
ML2051,ML2051HS,ML2051VR	29	58
ML2055,ML2055HS,ML2055VR	25	54
ML2057,ML2057HS,ML2057VR	31	60
ML2060,ML2060VR	33	62
ML2065,ML2065HS,ML2065VR	21	50
ML2067,ML2067HS,ML2067VR	35	64
ML2069,ML2069HS,ML2069VR	37	66
ML2072,ML2072HS,ML2072VR	39	68
ML2075,ML2075HS,ML2075VR	39	68

Exit Device Functions

MLE03	70
MLE04	70
MLE05	70
MLE06	72
MLE07	72
MLE08	74
MLE09	74

The warranty on Corbin Russwin products becomes void if the product is modified in any way, regardless of whether the modifications causes or contributes to any alleged defect. If a Corbin Russwin product is modified it may no longer meet industry certification and quality control standards applicable to the original product and is no longer a genuine Corbin Russwin product.

Copyright © 2000-2020, ASSA ABLOY Access and Egress Hardware Group, Inc. All rights reserved. Reproduction in whole or in part without the express written permission of ASSA ABLOY Access and Egress Hardware Group, Inc. is prohibited. Patent pending and/or patent www.assaabloydss.com/patents.



The Door Opens to New Compliance Requirements.



The *Americans with Disabilities Act* was signed into law on July 26, 1990. This Federal law has far-reaching implications on the application of door hardware products. As a manufacturer of a full line of life safety and security products, we want to help in the understanding of this law.

The summary below relates directly to the application and compliance of locksets as referenced in the *Americans with Disabilities Act*, which incorporates American National Standards Institute (ANSI) A117.1 specifications.

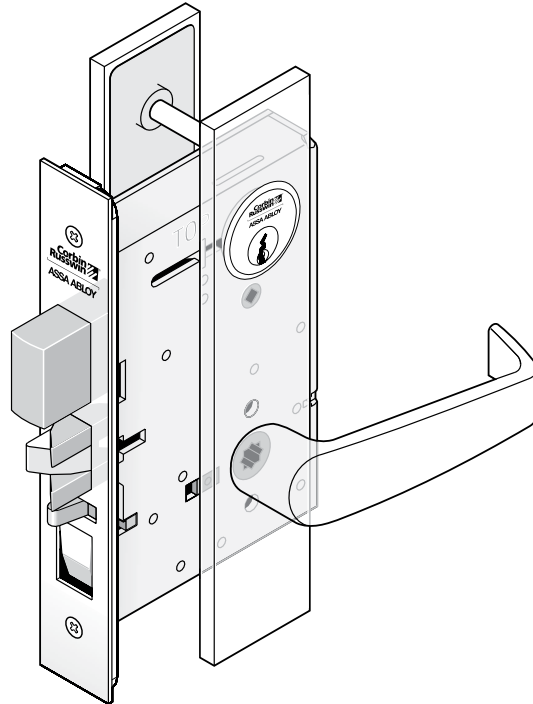

Summary of Requirements:

Locksets

“Handles, pulls, latches, locks and other operating devices on accessible doors shall have a shape that is easy to grasp with one hand and does not require tight grasping, tight pinching, or twisting of the wrist to operate. Lever-operated mechanisms, push-type mechanisms and U-shaped handles are acceptable designs.”

Mortise Lock Conversion Kit is available to convert knob x knob operation to lever x lever operation. See page104.

The foregoing is only a summary of the applicable regulations and your attention is directed to the Federal Disabilities Act and ANSIA117.1 for complete details and regulations. Since the application of the Act depends on specific site circumstances, you should use this summary only as a general guide and be sure to review local and state standards which may contain additional or modified requirements. For further information contact the Architectural and Transportation Barriers Compliance Board.

The warranty on Corbin Russwin products becomes void if the product is modified in any way, regardless of whether the modifications causes or contributes to any alleged defect. If a Corbin Russwin product is modified it may no longer meet industry certification and quality control standards applicable to the original product and is no longer a genuine Corbin Russwin product.

Copyright © 2000-2020, ASSA ABLOY Access and Egress Hardware Group, Inc. All rights reserved. Reproduction in whole or in part without the express written permission of ASSA ABLOY Access and Egress Hardware Group, Inc. is prohibited. Patent pending and/or patent www.assaabloydss.com/patents.

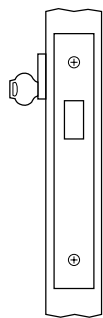

Deadbolt by Key Outside (No Inside Operation) ANSI F18 PG 8

	For 1-3/4" Min. Doors	For 1-3/8" Doors	
Type	Standard Master Ring	1" Front	High Security
Function	ML2011 MR Option	D138 Option	-----

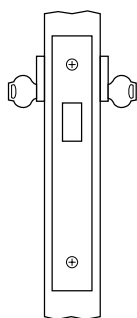

Deadbolt by Key Either Side ANSI F16 PG 8

	For 1-3/4" Min. Doors	For 1-3/8" Doors	
Type	Standard Master Ring	1" Front	High Security
Function	ML2012 MR Option	D138 Option	-----

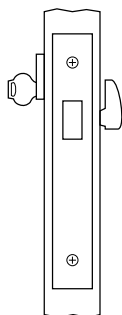

Deadbolt by Key Outside or by Thumbturn Lever Inside ANSI F17 PG 8

	For 1-3/4" Min. Doors	For 1-3/8" Doors	
Type	Standard Master Ring	1" Front	High Security
Function	ML2013 MR Option	D138 Option	ML2013HS

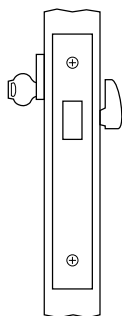

**Deadbolt by Key Outside/Thumbturn Lever Inside Retracts
Deadbolt Only (Will Not Project Deadbolt) PG 10**

	For 1-3/4" Min. Doors	For 1-3/8" Doors	
Type	Standard Master Ring	1" Front	High Security
Function	ML2017 MR Option	D138 Option	-----

The warranty on Corbin Russwin products becomes void if the product is modified in any way, regardless of whether the modifications causes or contributes to any alleged defect. If a Corbin Russwin product is modified it may no longer meet industry certification and quality control standards applicable to the original product and is no longer a genuine Corbin Russwin product.

Copyright © 2000-2020, ASSA ABLOY Access and Egress Hardware Group, Inc. All rights reserved. Reproduction in whole or in part without the express written permission of ASSA ABLOY Access and Egress Hardware Group, Inc. is prohibited. Patent pending and/or patent www.assaabloydss.com/patents.

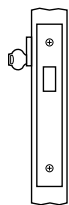

Deadbolt by Key Outside (No Inside Operation)

	For 1-3/4" Min. Doors	For 1-3/8" Doors
Type	Standard Master Ring	1" Front
Function	ML2011 -----	D138 Option

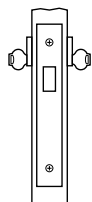

Deadbolt by Key Either Side

	For 1-3/4" Min. Doors	For 1-3/8" Doors
Type	Standard Master Ring	1" Front
Function	ML2012 MR Option	D138 Option

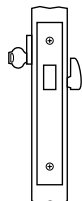

Deadbolt by Key Outside or by Thumbturn Lever Inside

	For 1-3/4" Min. Doors			For 1-3/8" Doors
Type	Standard	Master Ring	High Security	1" Front
Function	ML2013	MR Option	ML2013HS	D138 Option

Item	Part No.	Description
S/A	701F06-8*	Deadlock Body No Cylinder or trim for Standard
	701F16-8	D138 Option
	711F06-8	MR Option
	792F06-8	High Security
	1	687F53-8* 687F54-8 687F58-8
2	700F27-8* 701F57-8	Cap, Case for Standard MR Option
9	700F23-5 700F31-5	Hub, Turnpiece for Standard MR Option
11	702F98-7	Deadbolt
12	701F22-8**	Spring, Deadbolt
31	402F73-8*	Bracket, Cylinder Set Screw

Item	Part No.	Description
35	684F18-8**	Screw, FHUM-PH-TITE #8-32x3/8"
50	079F00	Armored Front for Standard & High Security
	079F02	D138 Option
51	236L74018	Std. Strike (See page 76 options)
52	429F41	<i>Specialty Finish</i> Mortise Lock Mounting packet for Standard
	488F09	MR Option
	465F57	High Security (M04) MR x M04 (see pg 109 for packet descriptions)
	616F12	NOTE: For double cylinder functions an additional cylinder set screw is required. Cylinder Set Screw for
	488F08-8 488F10-8	Standard MR Option

*For M26 Option, replace suffix "-8" with "2".
**For M26 Option, replace suffix "-8" with "-7".

The warranty on Corbin Russwin products becomes void if the product is modified in any way, regardless of whether the modifications causes or contributes to any alleged defect. If a Corbin Russwin product is modified it may no longer meet industry certification and quality control standards applicable to the original product and is no longer a genuine Corbin Russwin product.

Copyright © 2000-2020, ASSA ABLOY Access and Egress Hardware Group, Inc. All rights reserved. Reproduction in whole or in part without the express written permission of ASSA ABLOY Access and Egress Hardware Group, Inc. is prohibited. Patent pending and/or patent www.assaabloydss.com/patents.



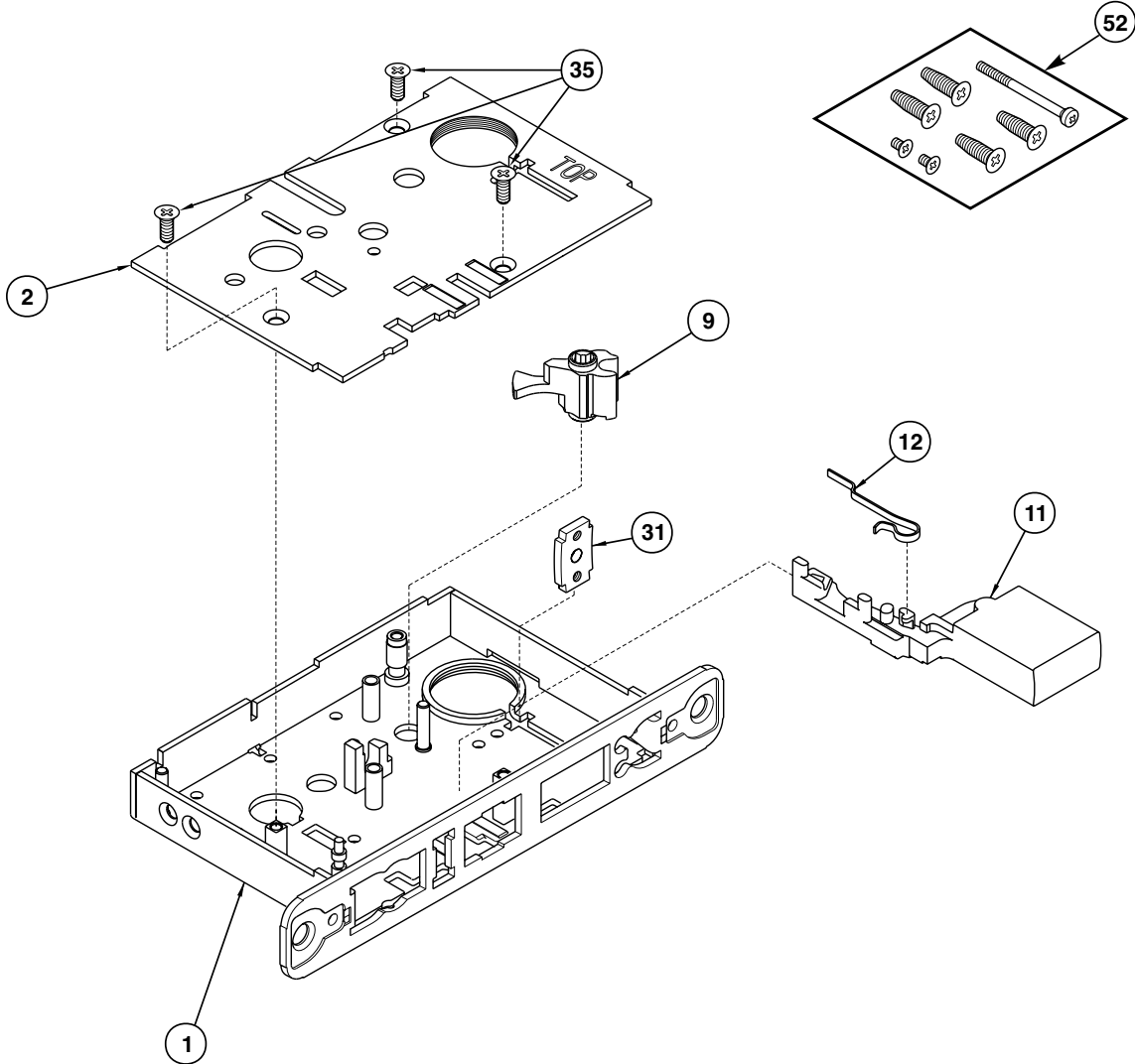
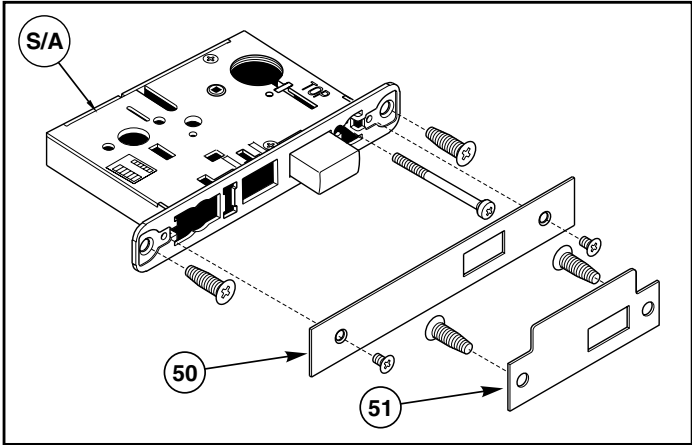

The warranty on Corbin Russwin products becomes void if the product is modified in any way, regardless of whether the modifications causes or contributes to any alleged defect. If a Corbin Russwin product is modified it may no longer meet industry certification and quality control standards applicable to the original product and is no longer a genuine Corbin Russwin product.

Copyright © 2000-2020, ASSA ABLOY Access and Egress Hardware Group, Inc. All rights reserved. Reproduction in whole or in part without the express written permission of ASSA ABLOY Access and Egress Hardware Group, Inc. is prohibited. Patent pending and/or patent www.assaabloydss.com/patents.

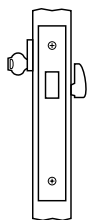

	For 1-3/4" Min. Doors	For 1-3/8" Doors
Type	Standard Master Ring	1" Front
Function	ML2017 -----	D138 Option

Item	Part No.	Description
S/A	701F26-8* 701F36-8	Deadlock Body No Cylinder or Thumbturn for Standard D138 Option
1	687F53-8* 687F54-8	Case & Front Sub Assembly for Standard D138 Option
2	700F27-8*	Cap, Case
9	700F23-5	Hub, Turnpiece
11	702F98-7	Deadbolt
12	701F22-8**	Spring Deadbolt
31	402F73-8*	Bracket, Cylinder Set Screw
35	684F18-8*	Screw, FHUM-PH-TITE #8-32 x 3/8"

Item	Part No.	Description
48	403F56-8*	Deadlock Body
49	403F66-8	Lever, Locking
50	<i>Specialty Finish</i> 079F00 079F02	Armored Front for Standard D138 Option
51	236L74018	Std. Strike (See pg. 76 for options)
52	<i>Specialty Finish</i> 429F41 465F57	Mortise Lock Mounting Packet for Standard M04 (See page 109 for packet descriptions)

*For M26 Option, replace suffix "-8" with "-2".
 **For M26 Option, replace suffix "-8" with "-7".

The warranty on Corbin Russwin products becomes void if the product is modified in any way, regardless of whether the modifications causes or contributes to any alleged defect. If a Corbin Russwin product is modified it may no longer meet industry certification and quality control standards applicable to the original product and is no longer a genuine Corbin Russwin product.

Copyright © 2000-2020, ASSA ABLOY Access and Egress Hardware Group, Inc. All rights reserved. Reproduction in whole or in part without the express written permission of ASSA ABLOY Access and Egress Hardware Group, Inc. is prohibited. Patent pending and/or patent www.assaabloydss.com/patents.

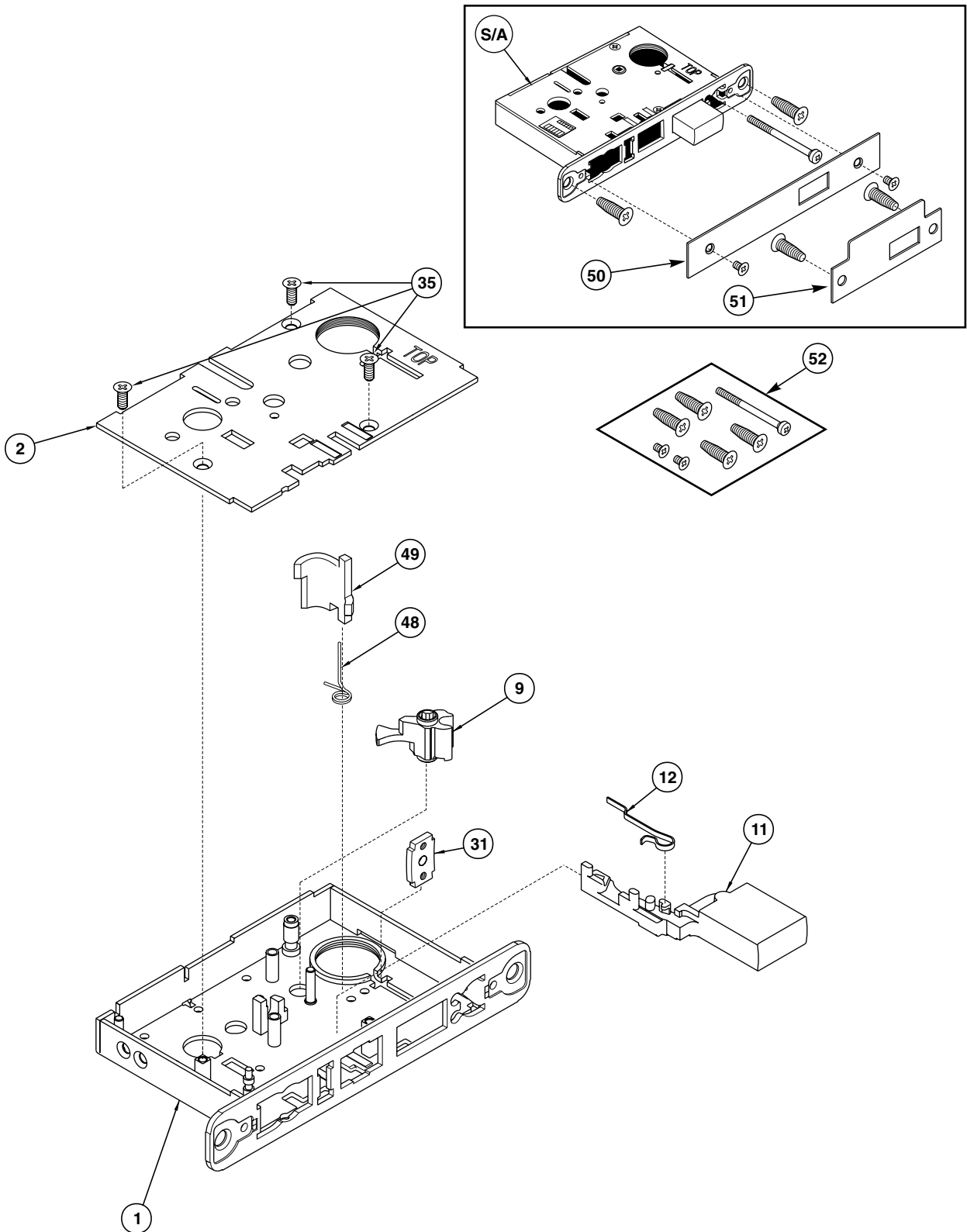

The warranty on Corbin Russwin products becomes void if the product is modified in any way, regardless of whether the modifications causes or contributes to any alleged defect. If a Corbin Russwin product is modified it may no longer meet industry certification and quality control standards applicable to the original product and is no longer a genuine Corbin Russwin product.

Copyright © 2000-2020, ASSA ABLOY Access and Egress Hardware Group, Inc. All rights reserved. Reproduction in whole or in part without the express written permission of ASSA ABLOY Access and Egress Hardware Group, Inc. is prohibited. Patent pending and/or patent www.assaabloydss.com/patents.

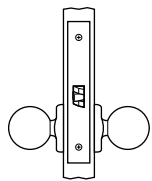

Passage or Closet ANSI F01 PG 14

	For 1-3/4" Min. Doors	For 1-3/8" Doors	
Type	Standard Master Ring	1" Front	High Security
Function	ML2010 -----	D138 Option	ML2010HS

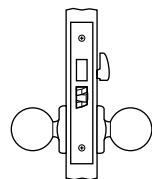

Privacy, Bedroom or Bathroom ANSI F02 PG 16

	For 1-3/4" Min. Doors	For 1-3/8" Doors	
Type	Standard Master Ring	1" Front	High Security
Function	ML2020 -----	D138 Option	ML2020HS

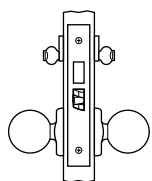

Store Door ANSI F14 PG 16

	For 1-3/4" Min. Doors	For 1-3/8" Doors	
Type	Standard Master Ring	1" Front	High Security
Function	ML2022 MR Option	D138 Option	ML2022HS

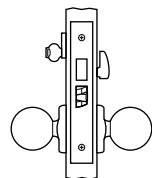

Entrance or Storeroom ANSI F21 PG 16

	For 1-3/4" Min. Doors	For 1-3/8" Doors	
Type	Standard Master Ring	1" Front	High Security
Function	ML2024 MR Option	D138 Option	ML2024HS

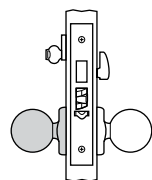

Hotel or Motel ANSI F15 PG 18

	For 1-3/4" Min. Doors	For 1-3/8" Doors	
Type	Standard Master Ring	1" Front	High Security
Function	ML2029 -----	D138 Option	ML2029HS

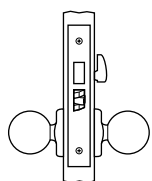

Privacy, Bedroom or Bathroom ANSI F19 PG 20

	For 1-3/4" Min. Doors	For 1-3/8" Doors	
Type	Standard Master Ring	1" Front	High Security
Function	ML2030 -----	D138 Option	ML2030HS

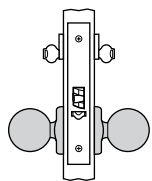

Institution or Utility PG 22

	For 1-3/4" Min. Doors	For 1-3/8" Doors	
Type	Standard Master Ring	1" Front	High Security
Function	ML2032 -----	D138 Option	ML2032HS

The warranty on Corbin Russwin products becomes void if the product is modified in any way, regardless of whether the modifications causes or contributes to any alleged defect. If a Corbin Russwin product is modified it may no longer meet industry certification and quality control standards applicable to the original product and is no longer a genuine Corbin Russwin product.

Copyright © 2000-2020, ASSA ABLOY Access and Egress Hardware Group, Inc. All rights reserved. Reproduction in whole or in part without the express written permission of ASSA ABLOY Access and Egress Hardware Group, Inc. is prohibited. Patent pending and/or patent www.assaabloydss.com/patents.

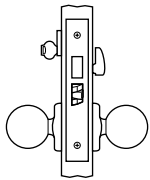

Entrance or Public Restroom ANSI F09 PG 24

	For 1-3/4" Min. Doors	For 1-3/8" Doors	
Type	Standard Master Ring	1" Front	High Security
Function	ML2042 MR Option	D138 Option	ML2042HS

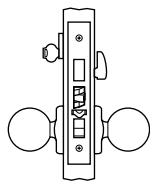

Entrance or Apartment ANSI F10 PG 26

	For 1-3/4" Min. Doors	For 1-3/8" Doors	
Type	Standard Master Ring	1" Front	High Security
Function	ML2048 MR Option	D138 Option	ML2048HS

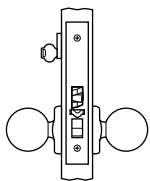

Entrance or Office ANSI F04 PG 28

	For 1-3/4" Min. Doors	For 1-3/8" Doors	
Type	Standard Master Ring	1" Front	High Security
Function	ML2051 MR Option	D138 Option	ML2051HS

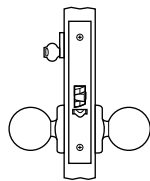

Classroom ANSI F05 PG 24

	For 1-3/4" Min. Doors	For 1-3/8" Doors	
Type	Standard Master Ring	1" Front	High Security
Function	ML2055 MR Option	D138 Option	ML2055HS

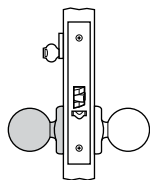

Storeroom or Closet ANSI F07 PG 30

	For 1-3/4" Min. Doors	For 1-3/8" Doors	
Type	Standard Master Ring	1" Front	High Security
Function	ML2029 -----	D138 Option	ML2029HS

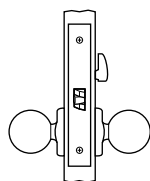

Privacy ANSI F22 PG 32

	For 1-3/4" Min. Doors	For 1-3/8" Doors	
Type	Standard Master Ring	1" Front	
Function	ML2060 -----	D138 Option	

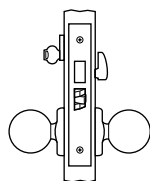

Dormitory, Entrance or Storeroom F 13 PG 20

	For 1-3/4" Min. Doors	For 1-3/8" Doors	
Type	Standard Master Ring	1" Front	High Security
Function	ML2065 MR Option	D138 Option	ML2065HS

The warranty on Corbin Russwin products becomes void if the product is modified in any way, regardless of whether the modifications causes or contributes to any alleged defect. If a Corbin Russwin product is modified it may no longer meet industry certification and quality control standards applicable to the original product and is no longer a genuine Corbin Russwin product.

Copyright © 2000-2020, ASSA ABLOY Access and Egress Hardware Group, Inc. All rights reserved. Reproduction in whole or in part without the express written permission of ASSA ABLOY Access and Egress Hardware Group, Inc. is prohibited. Patent pending and/or patent www.assaabloydss.com/patents.

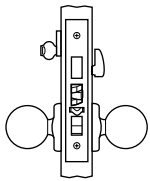

Apartment or Dormitory ANSI F20 PG 34

	For 1-3/4" Min. Doors	For 1-3/8" Doors	
Type	Standard Master Ring	1" Front	High Security
Function	ML2067 MR Option	D138 Option	ML2067HS

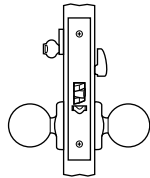

Institutional Privacy PG 36

	For 1-3/4" Min. Doors	For 1-3/8" Doors	
Type	Standard Master Ring	1" Front	High Security
Function	ML2069 -----	D138 Option	ML2069HS

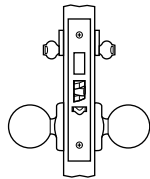

Classroom Security PG 38

	For 1-3/4" Min. Doors	For 1-3/8" Doors	
Type	Standard Master Ring	1" Front	High Security
Function	ML2072 MR Option	D138 Option	ML2072HS

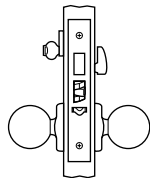

Classroom Security PG 38

	For 1-3/4" Min. Doors	For 1-3/8" Doors	
Type	Standard Master Ring	1" Front	High Security
Function	ML2075 MR Option	D138 Option	ML2075HS

The warranty on Corbin Russwin products becomes void if the product is modified in any way, regardless of whether the modifications causes or contributes to any alleged defect. If a Corbin Russwin product is modified it may no longer meet industry certification and quality control standards applicable to the original product and is no longer a genuine Corbin Russwin product.

Copyright © 2000-2020, ASSA ABLOY Access and Egress Hardware Group, Inc. All rights reserved. Reproduction in whole or in part without the express written permission of ASSA ABLOY Access and Egress Hardware Group, Inc. is prohibited. Patent pending and/or patent www.assaabloydss.com/patents.

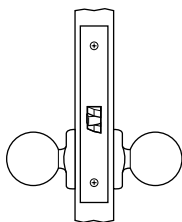

Passage or Closet

	For 1-3/4" Min. Doors		For 1-3/8" Doors
Type	Standard	Master Ring	High Security
Function	ML2010	-----	ML2010HS
			D138 Option

Item	Part No.	Description
S/A		Knoblock Body No Cylinder or Trim for
	701F10-8*	Standard
	792F20-8	D138 Option
	792F10	High Security
1		Case & Front Sub Assembly for
	687F53-8*	Standard & High Security
	687F54-8	D138 Option
2	700F27-8*	Cap, Case
4		Hub, Knob
	684F14-7	Deadbolt
	683F33-7	Spring Deadbolt
10	688F17-7	Latchbolt Sub Assembly
18	681F37-8*	Lever, Hub
19	688F03-8**	Retractor

Item	Part No.	Description
21	565F04-8**	Spring, Hub lever
35	684F18-8**	Screw, FHUM-PH-TITE #8-32 x 3/8"
50	<i>Specialty Finish</i>	Armored Front for
	423F55	Standard
	423F58	D138 Option
51	236L73 018	Std. Strike (See pg. 76 for options)
52	<i>Specialty Finish</i>	Mortise Lock Mounting Packet for
	429F41	Standard
	465F57	High Security (M04) (See page 109 for packet descriptions)

*For M26 Option, replace suffix "-8" with "-2".
 **For M26 Option, replace suffix "-8" with "-7".

The warranty on Corbin Russwin products becomes void if the product is modified in any way, regardless of whether the modifications causes or contributes to any alleged defect. If a Corbin Russwin product is modified it may no longer meet industry certification and quality control standards applicable to the original product and is no longer a genuine Corbin Russwin product.

Copyright © 2000-2020, ASSA ABLOY Access and Egress Hardware Group, Inc. All rights reserved. Reproduction in whole or in part without the express written permission of ASSA ABLOY Access and Egress Hardware Group, Inc. is prohibited. Patent pending and/or patent www.assaabloydss.com/patents.

Passage or Closet

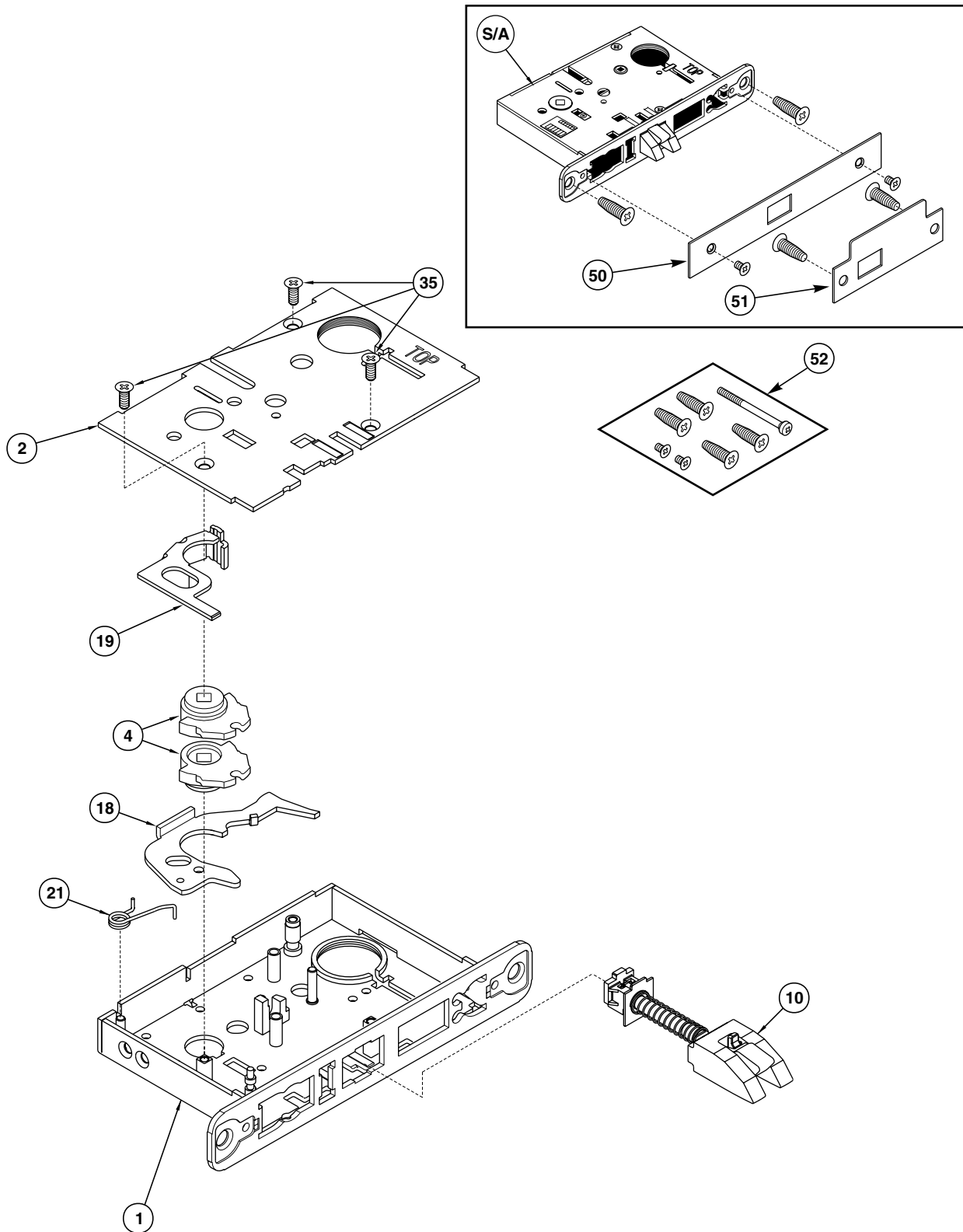

The warranty on Corbin Russwin products becomes void if the product is modified in any way, regardless of whether the modifications causes or contributes to any alleged defect. If a Corbin Russwin product is modified it may no longer meet industry certification and quality control standards applicable to the original product and is no longer a genuine Corbin Russwin product.

Copyright © 2000-2020, ASSA ABLOY Access and Egress Hardware Group, Inc. All rights reserved. Reproduction in whole or in part without the express written permission of ASSA ABLOY Access and Egress Hardware Group, Inc. is prohibited. Patent pending and/or patent www.assaabloydss.com/patents.

Privacy, Bedroom or Bathroom, Store Door, Entrance or Storeroom

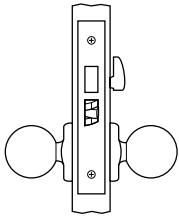

	For 1-3/4" Min. Doors	For 1-3/8" Doors
Type	Standard Master Ring High Security	1" Front
Function	ML2020 -----	ML2020HS D138 Option

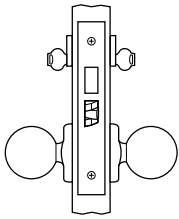

	For 1-3/4" Min. Doors	For 1-3/8" Doors
Type	Standard Master Ring High Security	1" Front
Function	ML2022 MR Option	ML2022HS D138 Option

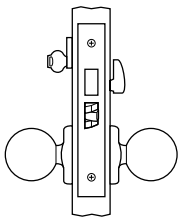

	For 1-3/4" Min. Doors	For 1-3/8" Doors
Type	Standard Master Ring High Security	1" Front
Function	ML2024 MR Option	ML2024HS D138 Option

Item	Part No.	Description
S/A		Knob Lock Body (No Cylinder or Trim) for
	701F05-8*	Standard
	701F15-8*	D138 Option
	711F05-8*	MR Option
	792F05-8	High Security
1		Case and Front Sub Assembly for
	687F3-8*	Standard
	687F54-8	D138 Option
	687F58-8	MR Option
2		Cap, Case for
	700F27-8*	Standard
	701F57-8	MR Option
4		Hub knob
	684F14-7	Standard
	683F33-7	High Security
7	684F05-5	Stop
9		Hub, Turnpiece for
	813F505	Standard
	700F31-5	MR Option
10	688F17-7	Latchbolt Sub Assembly

Item	Part No.	Description
11	702F987-7	Deadbolt
12	701F22-8**	Spring, Deadbolt
18	681F37-8*	Lever, Hub
19	688F03-8**	Retractor
21	565F04-8**	Spring, Hub, Lever
22	701F748 815F098	Lever, Cylinder latch MR Option
31	402F73-8*	Bracket, Cylinder Set Screw
50	<i>Specialty Finish</i> 423F54 423F57	Armored Front for Standard D138 Option

The warranty on Corbin Russwin products becomes void if the product is modified in any way, regardless of whether the modifications causes or contributes to any alleged defect. If a Corbin Russwin product is modified it may no longer meet industry certification and quality control standards applicable to the original product and is no longer a genuine Corbin Russwin product.

Copyright © 2000-2020, ASSA ABLOY Access and Egress Hardware Group, Inc. All rights reserved. Reproduction in whole or in part without the express written permission of ASSA ABLOY Access and Egress Hardware Group, Inc. is prohibited. Patent pending and/or patent www.assaabloydss.com/patents.

Privacy, Bedroom or Bathroom, Store Door, Entrance or Storeroom

Item	Part No.	Description
51	236L72018	Std. Strike (See pg. 76 for options)
52	<i>Specialty Finish</i>	Mortise Mounting Packet for
	429F41	Standard
	488F09	MR Option
	465F57	High Security (M04)
	616F12	MR & M04
		(See pg. 109 for packet descriptions) NOTE: For double cylinder functions an additional cylinder set screw is required.
		Cylinder Set Screw for
	488F08-8	Standard
	488F10-8	MR Option
53	700F95-7	Spring, Latch Lever

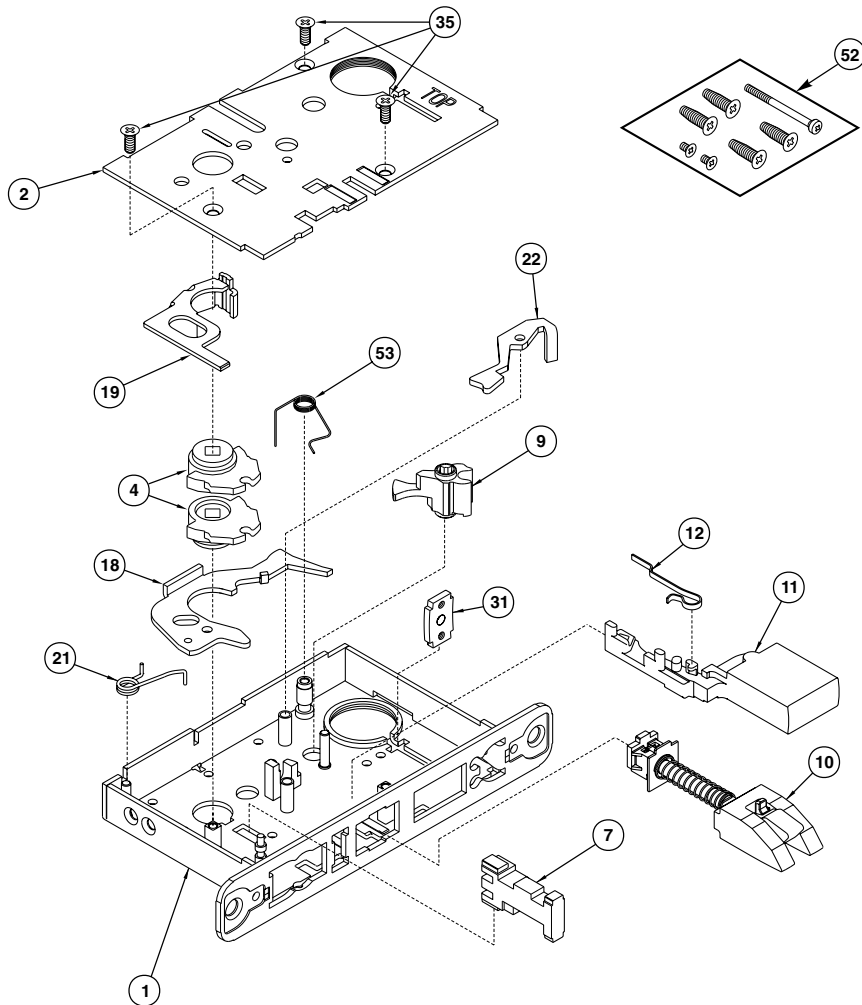
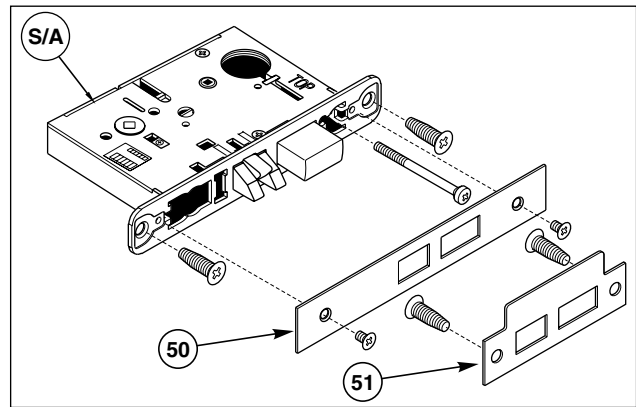

The warranty on Corbin Russwin products becomes void if the product is modified in any way, regardless of whether the modifications causes or contributes to any alleged defect. If a Corbin Russwin product is modified it may no longer meet industry certification and quality control standards applicable to the original product and is no longer a genuine Corbin Russwin product.

Copyright © 2000-2020, ASSA ABLOY Access and Egress Hardware Group, Inc. All rights reserved. Reproduction in whole or in part without the express written permission of ASSA ABLOY Access and Egress Hardware Group, Inc. is prohibited. Patent pending and/or patent www.assaabloydss.com/patents.

Hotel or Motel

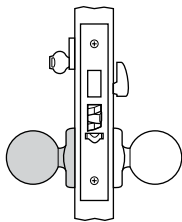

	For 1-3/4" Min. Doors	For 1-3/8" Doors
Type	Standard Master Ring	High Security
Function	ML2029 -----	ML2029HS
		1" Front
		D138 Option

Item	Part No.	Description
S/A	701F03-8* 701F13-8* 792F03-8	Knob Lock Body (No Cylinder or Trim) for Standard D138 Option MR Option High Security
1	687F53-8* 687F54-8	Case and Front Sub Assembly for Standard D138 Option
2	700F27-8*	Cap, Case
4	684F14-7 683F33-7	Hub knob Standard High Security
7	684F05-5	Stop
8	684F05-5	Stop Fixed
9	700F23-5	Hub, Turnpiece
10	688F17-7	Latchbolt Sub Assembly
11	702F98-7	Deadbolt
12	701F22-8*	Spring, Deadbolt
13	624F48-8*	Lever, Deadlocking
14	700F90-7	Spring, Deadlocking Lever
15	403F67-7	Latch, Auxiliary
16	678F54-8*	Lever Auxiliary

Item	Part No.	Description
17	678F67-7	Spring, Auxiliary Lever
18	681F36-8*	Lever, Hub
19	688F03-8**	Retractor
21	565F04-8**	Spring, Hub Lever
22	688F14-8*	Lever, Cylinder Latch
24	436F17-7	Ring, Retaining
31	402F73-8*	Bracket, Cylinder Set Screw
35	684F18-8*	Screw, FHUM-PH-TITE #8-32x3/8"
38	684F06-7	Screw, Stop
50	Specialty Finish 402F30 402F34	Armored Front for Standard D138 Option
51	236L72018	Std. Strike (See pg. 76 for options)
52	Specialty Finish 429F41 465F57	Mortise Lock Mounting Packet for Standard High Security (M04) (See pg. 109 for packet descriptions)
53	700F95-7	Spring, Latch Lever

*For M26 Option, replace suffix "-8" with "-2".
**For M26 Option, replace suffix "-8" with "-7".

The warranty on Corbin Russwin products becomes void if the product is modified in any way, regardless of whether the modifications causes or contributes to any alleged defect. If a Corbin Russwin product is modified it may no longer meet industry certification and quality control standards applicable to the original product and is no longer a genuine Corbin Russwin product.

Copyright © 2000-2020, ASSA ABLOY Access and Egress Hardware Group, Inc. All rights reserved. Reproduction in whole or in part without the express written permission of ASSA ABLOY Access and Egress Hardware Group, Inc. is prohibited. Patent pending and/or patent www.assaabloydss.com/patents.

Hotel or Motel

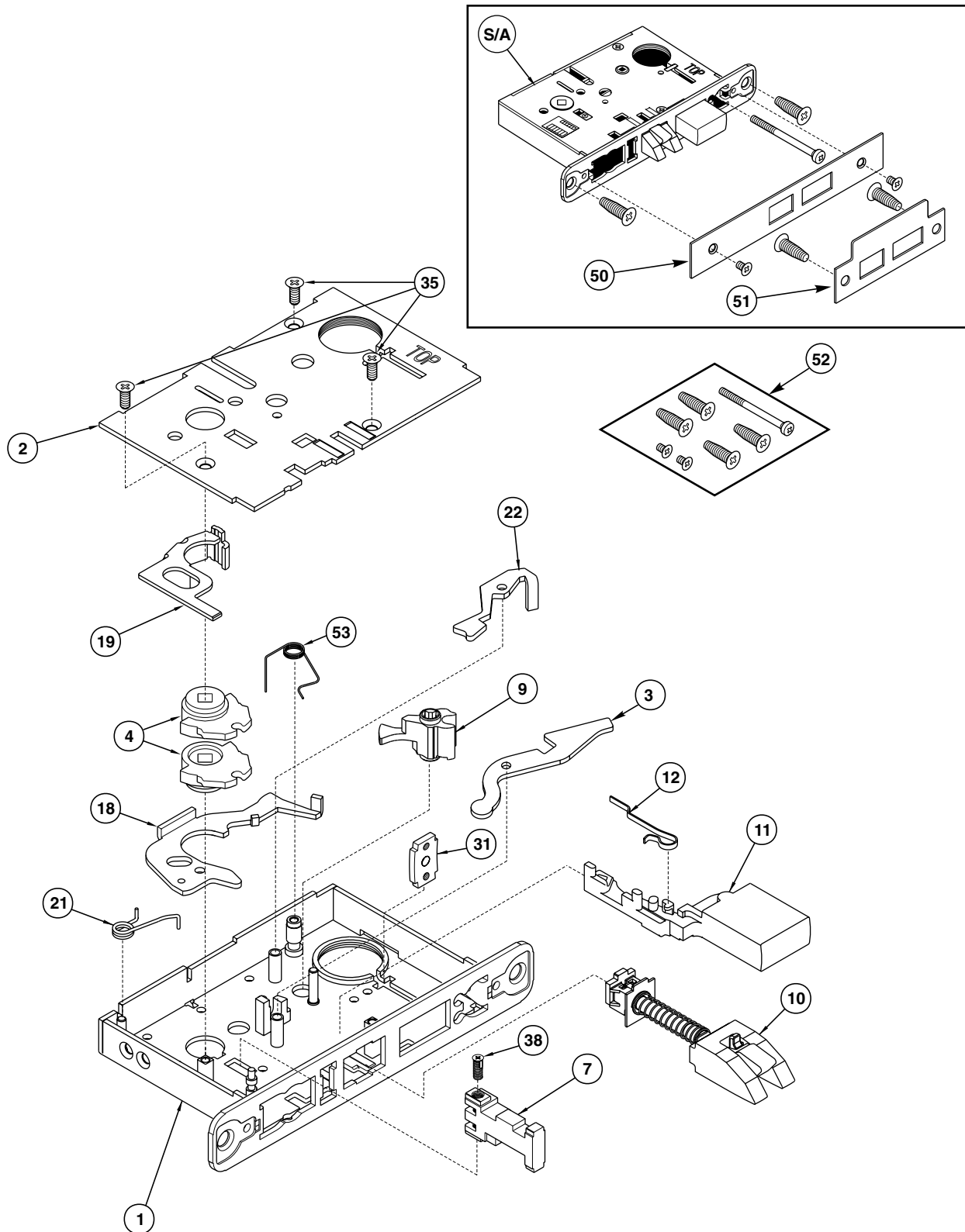

The warranty on Corbin Russwin products becomes void if the product is modified in any way, regardless of whether the modifications causes or contributes to any alleged defect. If a Corbin Russwin product is modified it may no longer meet industry certification and quality control standards applicable to the original product and is no longer a genuine Corbin Russwin product.

Copyright © 2000-2020, ASSA ABLOY Access and Egress Hardware Group, Inc. All rights reserved. Reproduction in whole or in part without the express written permission of ASSA ABLOY Access and Egress Hardware Group, Inc. is prohibited. Patent pending and/or patent www.assaabloydss.com/patents.

Privacy, Bedroom or Bathroom, Dormitory, Entrance or Storeroom

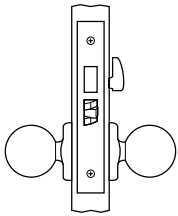

	For 1-3/4" Min. Doors		For 1-3/8" Doors
Type	Standard	Master Ring	High Security
Function	ML2030	-----	ML2030HS

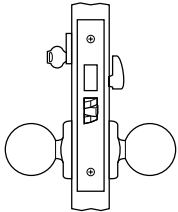

	For 1-3/4" Min. Doors		For 1-3/8" Doors
Type	Standard	Master Ring	High Security
Function	ML2065	MR Option	ML2065HS

Item	Part No.	Description
SA	701F02-8*	Knob Lock Body (No Cylinder or Trim) for Standard
	701F12-8*	D138 Option
	711F02-8	MR Option
	792F02-8	High Security
	1	687F53-8*
	687F54-8	D138 Option
	687F58-8	MR Option
2	700F27-8*	Cap, Case for Standard
	701F57-8	MR Option
3	700F70-8*	Lever, Stop
4	684F14-7	Hub, Knob Standard
	683F33-7	MR Option
7	684F05-5	Stop
9	700F23-5	Hub, Turnpiece for Standard
	700F31-5	MR Option
10	688F717-7	latchbolt Sub Assembly
11	702F98-7	Deadbolt

Item	Part No.	Description
12	701F22-8**	Spring, Deadbolt
18	681F36-8*	Lever, Hub
19	688F03-8**	Retractor
21	565F04-8**	Spring, hub lever
22	688F14-8*	Lever, Cylinder Latch
31	402F73-8*	Bracket, Cylinder Set Screw
35	684F18-8**	Screw, FHUM-PH-TITE #8-32x3/8"
38	684F06-7	Screw, Stop
50	<i>Specialty Finish</i> 423F54	Armored Front for Standard
	423F57	D138 Option
51	236L72018	Std. Strike (See pg. 76 for options)
52	<i>Specialty Finish</i> 429F41	Mortise Lock Mounting Packet for Standard
	488F09	MR Option
	465F57	High Security (M04)
	616F12	MR x M04 (See pg. 109 for Packet description)
53	700F95-7	Spring, Latch Lever

*For M26 Option, replace suffix "-8" with "-2".
 **For M26 Option, replace suffix "-8" with "-7".

The warranty on Corbin Russwin products becomes void if the product is modified in any way, regardless of whether the modifications causes or contributes to any alleged defect. If a Corbin Russwin product is modified it may no longer meet industry certification and quality control standards applicable to the original product and is no longer a genuine Corbin Russwin product.

Copyright © 2000-2020, ASSA ABLOY Access and Egress Hardware Group, Inc. All rights reserved. Reproduction in whole or in part without the express written permission of ASSA ABLOY Access and Egress Hardware Group, Inc. is prohibited. Patent pending and/or patent www.assaabloy.com/patents.

Privacy, Bedroom or Bathroom, Dormitory, Entrance or Storeroom

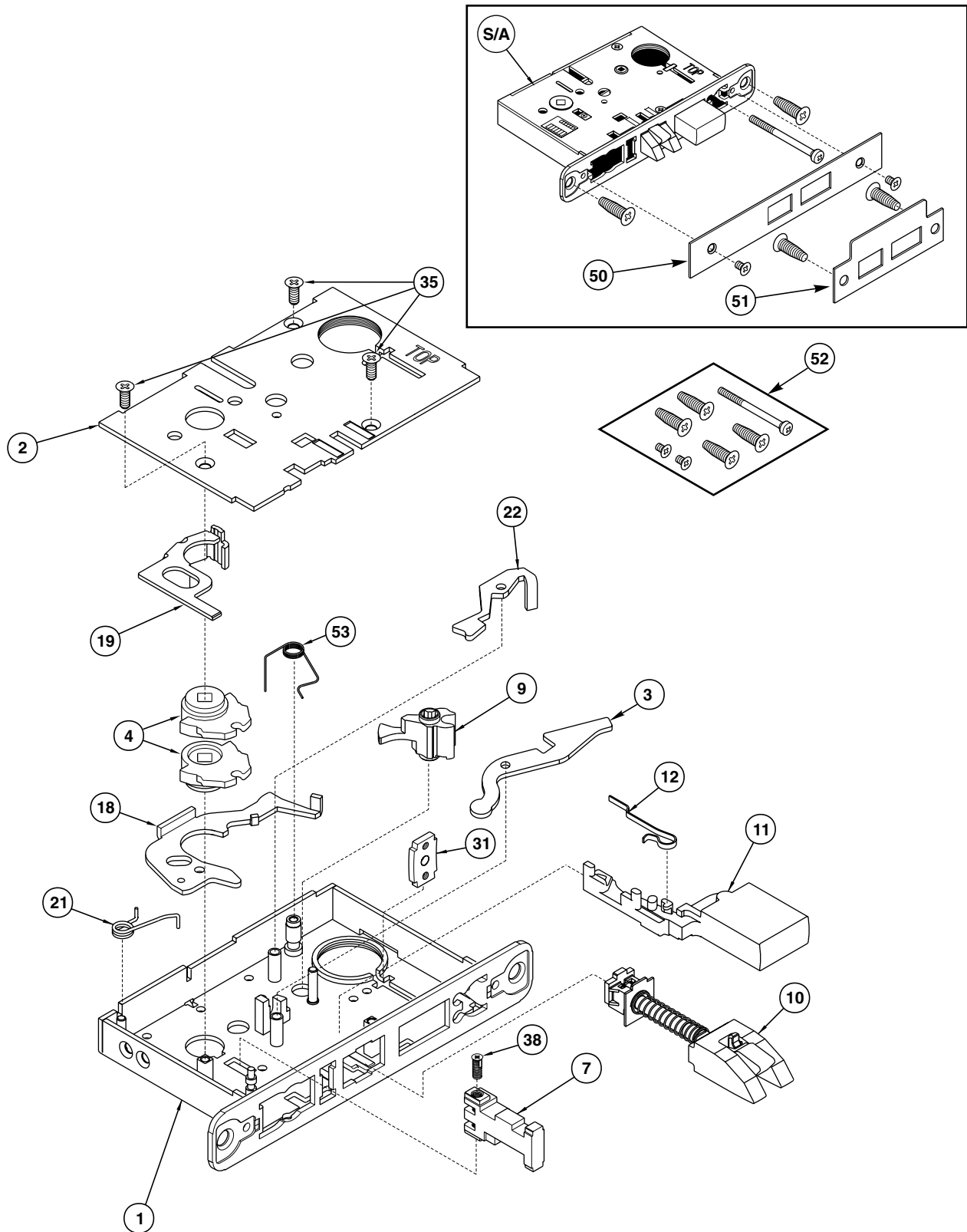

The warranty on Corbin Russwin products becomes void if the product is modified in any way, regardless of whether the modifications causes or contributes to any alleged defect. If a Corbin Russwin product is modified it may no longer meet industry certification and quality control standards applicable to the original product and is no longer a genuine Corbin Russwin product.

Copyright © 2000-2020, ASSA ABLOY Access and Egress Hardware Group, Inc. All rights reserved. Reproduction in whole or in part without the express written permission of ASSA ABLOY Access and Egress Hardware Group, Inc. is prohibited. Patent pending and/or patent www.assaabloydss.com/patents.

Privacy, Bedroom or Bathroom, Dormitory, Entrance or Storeroom

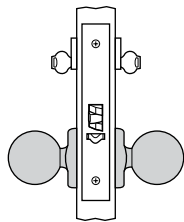

	For 1-3/4" Min. Doors		For 1-3/8" Doors
Type	Standard	Master Ring	High Security
Function	ML2032	MR Option	ML2032HS
			D138 Option

Item	Part No.	Description
S/A		Knob Lock Body (No Cylinder or Trim) for
	701F29-8*	Standard
	701F39-8*	D138 Option
	711F29-8*	MR Option
	792F29-8	High Security
1		Case & Front Sub Assembly for
	687F53-8*	Standard
	687F54-8	D138 Option
	687F58-8	MR Option
2		Cap, Case for
	700F27-8*	Standard
	701F57-8	MR Option
4		Hub, Knob
	684F14-7	Standard
	683F33-7	High Security
7	684F05-5	Stop
8	684F55-9	Stop, Fixed
10	688F17-7	Latchbolt Sub Assembly
13	624F48-8*	Lever, Deadlocking
14	700F90-7	Spring, Deadlocking Lever
15	403F67-7	Latch, Auxiliary
16	678F54-8*	Lever, Auxiliary
17	678F67-7	Spring, Auxiliary Lever

Item	Part No.	Description
22	688-F14-8*	Lever, Cylinder Latch
23	681F48-9	Stop, Cylinder Latch Lever
24	436F17-7	Ring, Retaining
31	402F73-8*	Bracket, Cylinder Set Screw
35	684F18-8**	Screw, FHUM-PH-TITE #8-32 x 3/8"
38	684F06-7	Screw, Stop
50	<i>Specify Finish</i>	Armored Front for
	624F49	Standard
	624F53	D138 Option
51	236L73 018	Std. Strike (See page 76 for options)
52	<i>Specify Finish</i>	Mortise Lock Mounting Packet for
	429F41	Standard
	488F09	MR Option
	465F57	High Security (M04)
	616F12	MR x M04 (See page 109 for packet descriptions)
		NOTE: For double cylinder functions an additional cylinder set screw is required.
		Cylinder Set Screw for
	488F08-8	Standard
	488F10-8	MR Option

*For M26 Option, replace suffix "-8" with "-2".
 **For M26 Option, replace suffix "-8" with "-7".

The warranty on Corbin Russwin products becomes void if the product is modified in any way, regardless of whether the modifications causes or contributes to any alleged defect. If a Corbin Russwin product is modified it may no longer meet industry certification and quality control standards applicable to the original product and is no longer a genuine Corbin Russwin product.

Copyright © 2000-2020, ASSA ABLOY Access and Egress Hardware Group, Inc. All rights reserved. Reproduction in whole or in part without the express written permission of ASSA ABLOY Access and Egress Hardware Group, Inc. is prohibited. Patent pending and/or patent www.assaabloydss.com/patents.

Institution or Utility

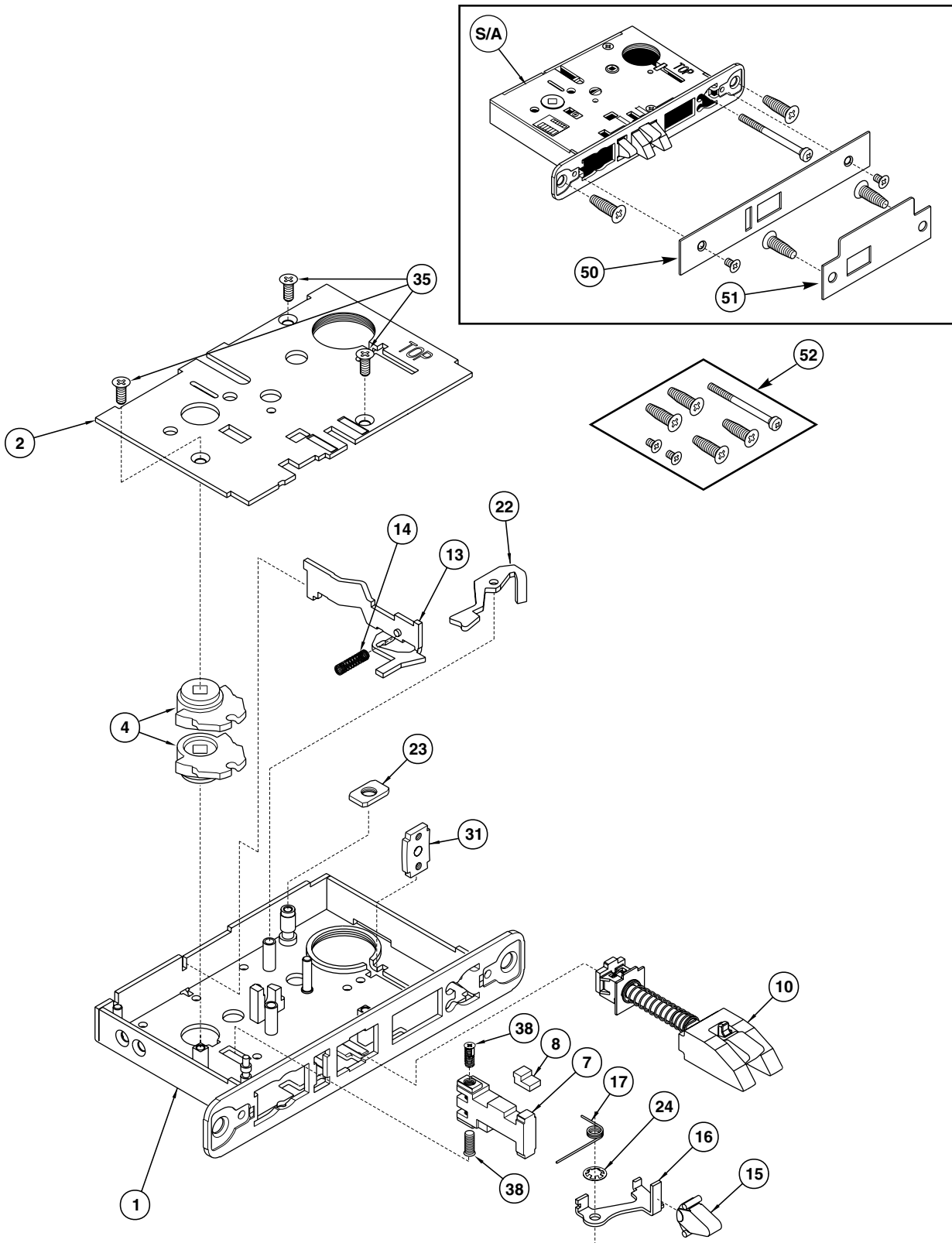

The warranty on Corbin Russwin products becomes void if the product is modified in any way, regardless of whether the modifications causes or contributes to any alleged defect. If a Corbin Russwin product is modified it may no longer meet industry certification and quality control standards applicable to the original product and is no longer a genuine Corbin Russwin product.

Copyright © 2000-2020, ASSA ABLOY Access and Egress Hardware Group, Inc. All rights reserved. Reproduction in whole or in part without the express written permission of ASSA ABLOY Access and Egress Hardware Group, Inc. is prohibited. Patent pending and/or patent www.assaabloydss.com/patents.

Entrance, Public Restroom or Classroom

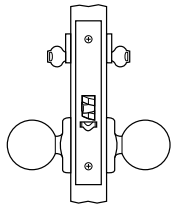

	For 1-3/4" Min. Doors		For 1-3/8" Doors	
Type	Standard	Master Ring	High Security	1" Front
Function	ML2042	MR Option	ML2042HS	D138 Option

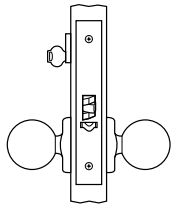

	For 1-3/4" Min. Doors		For 1-3/8" Doors	
Type	Standard	Master Ring	High Security	1" Front
Function	ML2055	MR Option	ML2055HS	D138 Option

Item	Part No.	Description
S/A		Knob Lock Body (No Cylinder or Trim) for
	701F08-8*	Standard
	701F18-8*	D138 Option
	711F08-8*	MR Option
	792F08-8	High Security
	780F08-8	Latch Hold Back
	780F18-8	LHB x D138
1		Case & Front Sub Assembly for
	687F53-8*	Standard
	687F54-8*	D138 Option
	687F58-8*	MR Option
2		Cap, Case for
	700F27-8*	Standard
	701F57-8*	MR Option
3	681F44-8*	Lever, Stop
4		Hub, Knob
	684F14-7	Standard
	683F33-7	High Security
7	684F05-5	Stop
10	688F17-7	Latchbolt Sub Assembly
13	624F48-8*	Lever, Deadlocking
14	700F90-7	Spring, Deadlocking Lever
15	403F67-7	Latch, Auxiliary
16	678F54-8*	Lever, Auxiliary
17	678F67-7	Spring, Auxiliary Lever

Item	Part No.	Description
18	681F37-8*	Lever, Hub
19	688F03-8**	Retractor
21	565F04-8**	Spring, Hub Lever
22	688F14-8*	Lever, Cylinder Latch
23	681F48-9	Stop, Cylinder Latch Lever
24	436F17-7	Ring, Retaining
25	685F38-7	Spring, Stop
31	402F73-8*	Bracket, Cylinder Set Screw
33	701F70-5	Lever, Stop Cylinder
35	684F18-8**	Screw, FHUM-PH-TITE #8-32 x 3/8"
38	684F06-7	Screw, Stop
43	701F56-5***	Lever, Hold Back
50	<i>Specify Finish</i>	Armored Front for
	624F49	Standard
	624F53	D138 Option
	681F34	LHB
	681F35	LHB & D138
51	236L73 018	Strike (See page 76 for options)
52	<i>Specify Finish</i>	Mortise Lock Mounting Packet for
	429F41	Standard
	488F09	MR Option
	465F57	High Security (M04)
	616F12	MR & M04 (See page 109 for packet descriptions)
		NOTE: For double cylinder functions an additional cylinder set screw is required.
		Cylinder Set Screw for
	488F08-8	Standard & High Security
	488F10-8	MR Option

*For M26 Option, replace suffix "-8" with "-2".
 **For M26 Option, replace suffix "-8" with "-7".
 ***For LHB Option.

The warranty on Corbin Russwin products becomes void if the product is modified in any way, regardless of whether the modifications causes or contributes to any alleged defect. If a Corbin Russwin product is modified it may no longer meet industry certification and quality control standards applicable to the original product and is no longer a genuine Corbin Russwin product.

Copyright © 2000-2020, ASSA ABLOY Access and Egress Hardware Group, Inc. All rights reserved. Reproduction in whole or in part without the express written permission of ASSA ABLOY Access and Egress Hardware Group, Inc. is prohibited. Patent pending and/or patent www.assaabloydss.com/patents.

Entrance, Public Restroom or Classroom

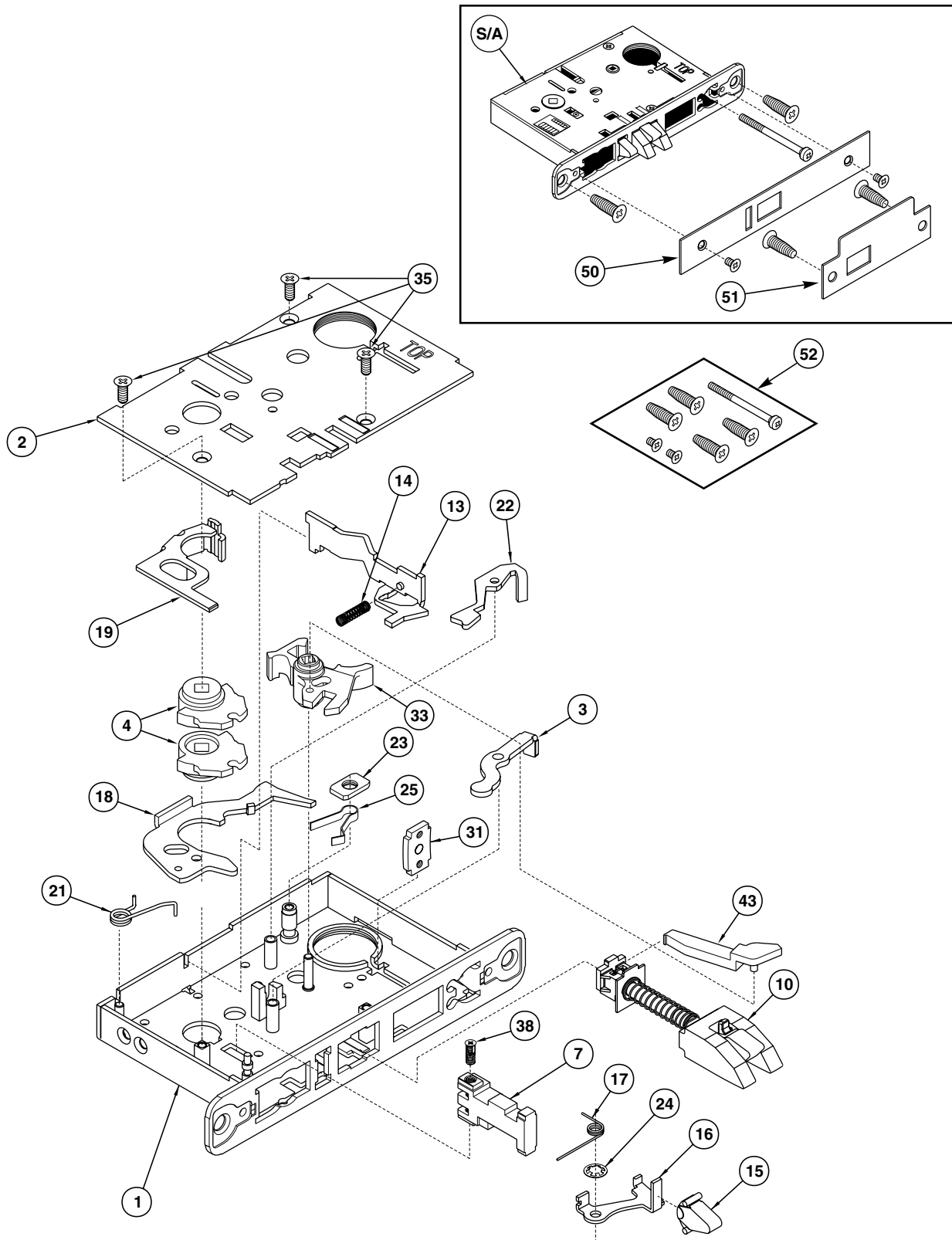

The warranty on Corbin Russwin products becomes void if the product is modified in any way, regardless of whether the modifications causes or contributes to any alleged defect. If a Corbin Russwin product is modified it may no longer meet industry certification and quality control standards applicable to the original product and is no longer a genuine Corbin Russwin product.

Copyright © 2000-2020, ASSA ABLOY Access and Egress Hardware Group, Inc. All rights reserved. Reproduction in whole or in part without the express written permission of ASSA ABLOY Access and Egress Hardware Group, Inc. is prohibited. Patent pending and/or patent www.assaabloydss.com/patents.

Entrance or Apartment

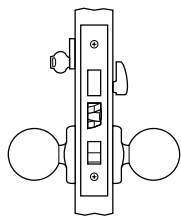

	For 1-3/4" Min. Doors		For 1-3/8" Doors
Type	Standard	Master Ring	High Security
Function	ML2048	MR Option	ML2048HS
			1" Front
			D138 Option

Item	Part No.	Description
S/A		Knob Lock Body (No Cylinder or Trim) for
	701F04-8*	Standard
	701F14-8*	D138 Option
	711F04-8*	MR Option
	792F04-8	High Security
1		Case & Front Sub Assembly for
	687F53-8*	Standard
	687F54-8*	D138 Option
	687F58-8*	MR Option
2		Cap, Case for
	700F27-8*	Standard
	701F57-8*	MR Option
4		Hub, Knob
	684F14-7	Standard
	683F33-7	High Security
7	684F05-5	Stop
9		Hub, Turnpiece for
	700F23-5	Standard
	700F31-5	MR Option
10	688F17-7	Latchbolt Sub Assembly
11	702F98-7	Deadbolt
12	701F22-8**	Spring, Deadbolt
18	681F37-8*	Lever, Hub

Item	Part No.	Description
19	688F03-8**	Retractor
21	565F04-8**	Spring, Hub Lever
22	688F14-8*	Lever, Cylinder Latch
26	461F01-2	Toggle Sub Assembly
27	402F63-7	Spring, Toggle
28	402F61-7	Spring, Seat
31	402F73-8*	Bracket, Cylinder Set Screw
35	684F18-8**	Screw, FHUM-PH-TITE #8-32 x 3/8"
38	684F06-7	Screw, Stop
50		Armored Front for
	402F31	Standard
	402F35	D138 Option
51	236L72 018	Std. Strike (See page 76 for options)
52		Mortise Lock Mounting Packet for
	429F41	Standard
	488F09	MR Option
	465F57	High Security (M04)
	616F12	MR x M04(See page 109 for packet descriptions)
53	700F95-7	Spring, Latch Lever

*For M26 Option, replace suffix "-8" with "-2".

**For M26 Option, replace suffix "-8" with "-7".

The warranty on Corbin Russwin products becomes void if the product is modified in any way, regardless of whether the modifications causes or contributes to any alleged defect. If a Corbin Russwin product is modified it may no longer meet industry certification and quality control standards applicable to the original product and is no longer a genuine Corbin Russwin product.

Copyright © 2000-2020, ASSA ABLOY Access and Egress Hardware Group, Inc. All rights reserved. Reproduction in whole or in part without the express written permission of ASSA ABLOY Access and Egress Hardware Group, Inc. is prohibited. Patent pending and/or patent www.assaabloydss.com/patents.

Entrance or Apartment

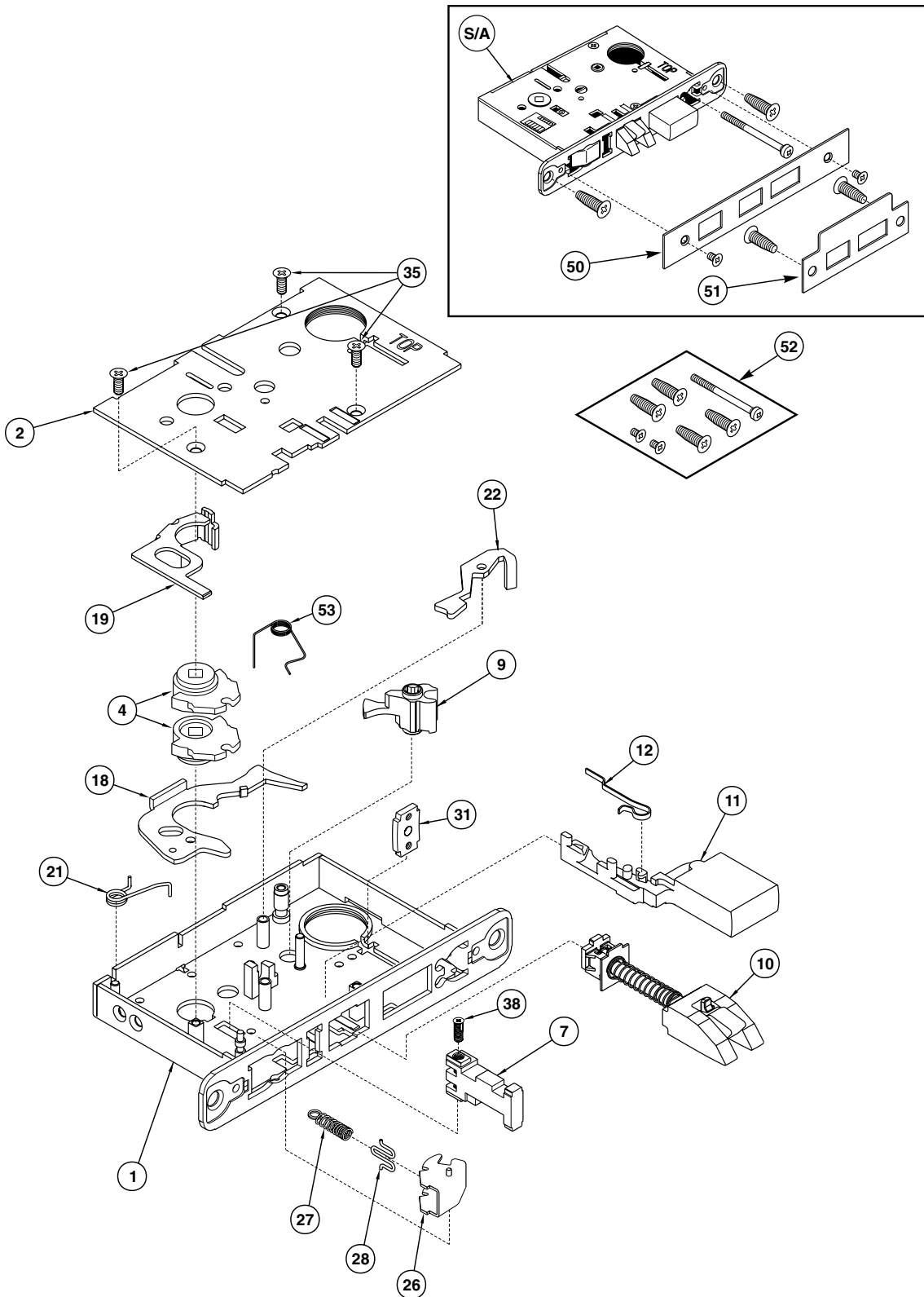

The warranty on Corbin Russwin products becomes void if the product is modified in any way, regardless of whether the modifications causes or contributes to any alleged defect. If a Corbin Russwin product is modified it may no longer meet industry certification and quality control standards applicable to the original product and is no longer a genuine Corbin Russwin product.

Copyright © 2000-2020, ASSA ABLOY Access and Egress Hardware Group, Inc. All rights reserved. Reproduction in whole or in part without the express written permission of ASSA ABLOY Access and Egress Hardware Group, Inc. is prohibited. Patent pending and/or patent www.assaabloydss.com/patents.

Entrance or Office

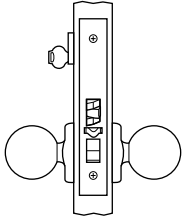

	For 1-3/4" Min. Doors		For 1-3/8" Doors	
Type	Standard	Master Ring	High Security	1" Front
Function	ML2051	MR Option	ML2051HS	D138 Option

Item	Part No.	Description
S/A		Knob Lock Body (No Cylinder or Trim) for
	701F07-8*	Standard
	701F17-8*	D138 Option
	711F07-8*	MR Option
	792F17-8	High Security
	780F07-8	Latch Hold Back Option
	780F17-8	LHB x D138
1		Case & Front Sub Assembly for
	687F53-8*	Standard
	687F54-8*	D138 Option
	687F58-8*	MR Option
2		Cap, Case for
	700F27-8*	Standard
	701F57-8*	MR Option
4		Hub, Knob
	684F14-7	Standard
	683F33-7	High Security
7	684F05-5	Stop
10	688F17-7	Latchbolt Sub Assembly
13	602F19-8*	Lever, Deadlocking
14	700F90-7	Spring, Deadlocking Lever
15	403F67-7	Latch, Auxiliary
16	678F54-8*	Lever, Auxiliary
17	678F67-7	Spring, Auxiliary Lever
18	681F37-8*	Lever, Hub
19	688F03-8**	Retractor
21	565F04-8**	Spring, Hub Lever

Item	Part No.	Description
22	701F748	Lever, Cylinder Latch
23	705F949	Stop, Cylinder Latch Lever
24	436F17-7	Ring, Retaining
25	685F38-7***	Spring, Stop
31	402F73-8*	Bracket, Cylinder Set Screw
33	701F70-5***	Lever, Stop Cylinder
35	684F18-8**	Screw, FHUM-PH-TITE #8-32 x 3/8"
38	684F06-7	Screw, Stop
43	701F565	Lever, Hold Back
50	<i>Specify Finish</i>	Armored Front for
	681F31	Standard
	681F30	D138 Option
	681F41	LHB
	681F40	LHB & D138
51	236L73 018	Std. Strike (See page 76 for options)
52	<i>Specify Finish</i>	Mortise Lock Mounting Packet for
	429F41	Standard
	488F09	MR Option
	465F57	High Security (M04)
	616F12	MR & M04 (See page 109 for packet descriptions)

*For M26 Option, replace suffix "-8" with "-2".
 **For M26 Option, replace suffix "-8" with "-7".
 ***For LHB Option.

The warranty on Corbin Russwin products becomes void if the product is modified in any way, regardless of whether the modifications causes or contributes to any alleged defect. If a Corbin Russwin product is modified it may no longer meet industry certification and quality control standards applicable to the original product and is no longer a genuine Corbin Russwin product.

Copyright © 2000-2020, ASSA ABLOY Access and Egress Hardware Group, Inc. All rights reserved. Reproduction in whole or in part without the express written permission of ASSA ABLOY Access and Egress Hardware Group, Inc. is prohibited. Patent pending and/or patent www.assaabloyds.com/patents.

Entrance or Office

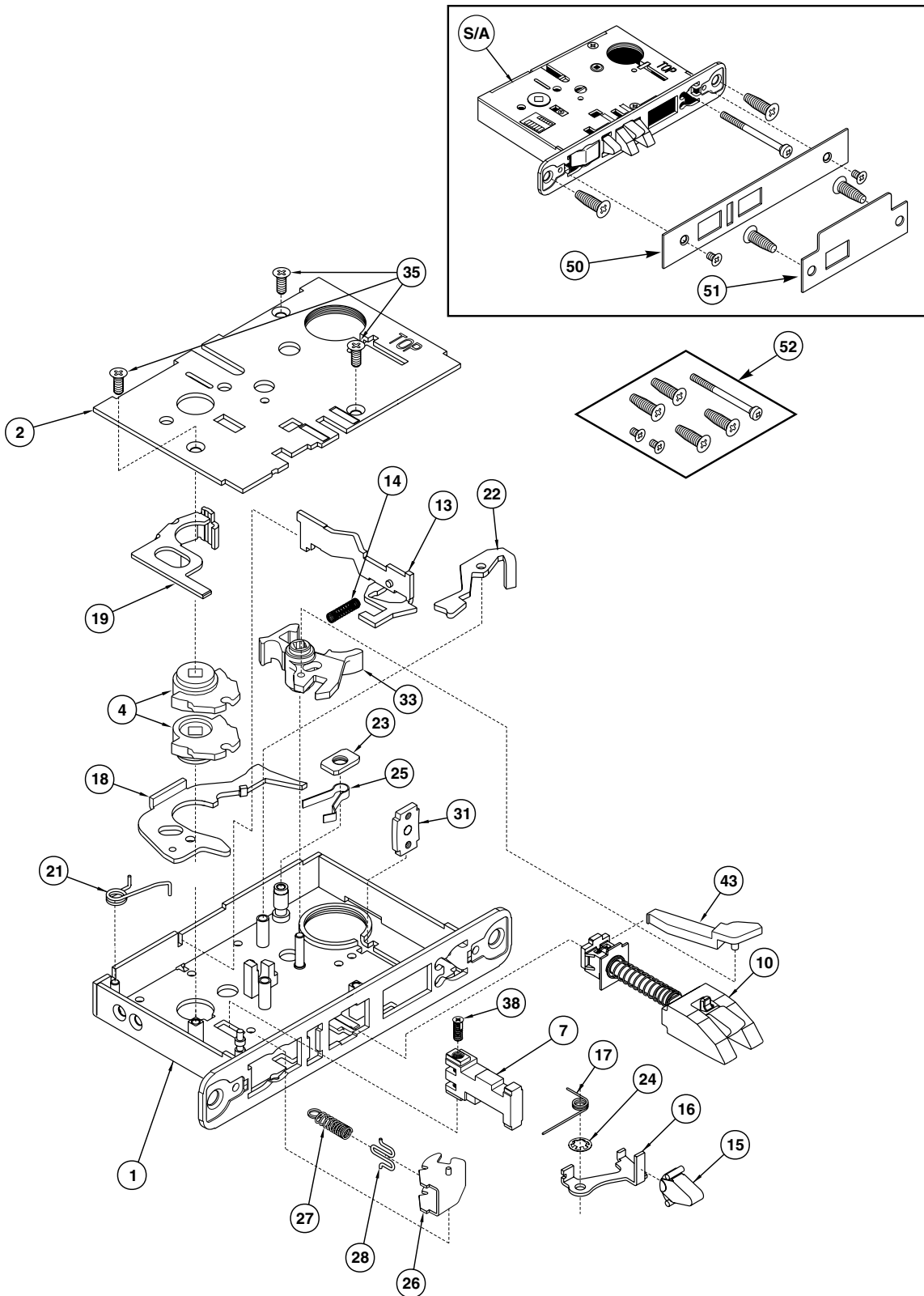

The warranty on Corbin Russwin products becomes void if the product is modified in any way, regardless of whether the modifications causes or contributes to any alleged defect. If a Corbin Russwin product is modified it may no longer meet industry certification and quality control standards applicable to the original product and is no longer a genuine Corbin Russwin product.

Copyright © 2000-2020, ASSA ABLOY Access and Egress Hardware Group, Inc. All rights reserved. Reproduction in whole or in part without the express written permission of ASSA ABLOY Access and Egress Hardware Group, Inc. is prohibited. Patent pending and/or patent www.assaabloydss.com/patents.

Storeroom or Closet

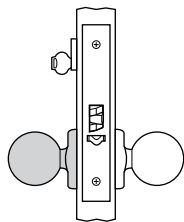

	For 1-3/4" Min. Doors		For 1-3/8" Doors	
Type	Standard	Master Ring	High Security	1" Front
Function	ML2057	MR Option	ML2057HS	D138 Option

Item	Part No.	Description
S/A		Knob Lock Body (No Cylinder or Trim) for
	701F09-8*	Standard
	701F19-8*	D138 Option
	711F09-8*	MR Option
	792F09-8	High Security
	780F09-8	Latch Hold Back Option
	780F19-8	LHB x D138
1		Case & Front Sub Assembly for
	687F53-8*	Standard
	687F54-8*	D138 Option
	687F58-8*	MR Option
2		Cap, Case for
	700F27-8*	Standard
	701F57-8*	MR Option
4		Hub, Knob
	684F14-7	Standard
	683F33-7	High Security
7	684F05-5	Stop
8	684F55-9	Stop, Fixed
10	688F17-7	Latchbolt Sub Assembly
13	602F19-8*	Lever, Deadlocking
14	700F90-7	Spring, Deadlocking Lever
15	403F67-7	Latch, Auxiliary
16	678F54-8*	Lever, Auxiliary
17	678F67-7	Spring, Auxiliary Lever
18	681F37-8*	Lever, Hub
19	688F03-8**	Retractor
21	565F04-8**	Spring, Hub Lever

Item	Part No.	Description
22	701F748	Lever, Cylinder Latch
23	705F949	Stop, Cylinder Latch Lever
24	436F17-7	Ring, Retaining
25	685F38-7***	Spring, Stop
31	402F73-8*	Bracket, Cylinder Set Screw
33	701F70-5***	Lever, Stop Cylinder
35	684F18-8**	Screw, FHUM-PH-TITE #8-32 x 3/8"
38	684F06-7	Screw, Stop
43	701F565	Lever, Hold Back
50	<i>Specify Finish</i>	Armored Front for
	624F49	Standard
	624F53	D138 Option
	681F34	LHB
	681F35	LHB & D138
51	236L73 018	Std. Strike (See page 76 for options)
52	<i>Specify Finish</i>	Mortise Lock Mounting Packet for
	429F41	Standard
	488F09	MR Option
	465F57	High Security (M04)
	616F12	MR & M04 (See page 109 for packet descriptions)

*For M26 Option, replace suffix "-8" with "-2".

**For M26 Option, replace suffix "-8" with "-7".

***For LHB Option.

The warranty on Corbin Russwin products becomes void if the product is modified in any way, regardless of whether the modifications causes or contributes to any alleged defect. If a Corbin Russwin product is modified it may no longer meet industry certification and quality control standards applicable to the original product and is no longer a genuine Corbin Russwin product.

Copyright © 2000-2020, ASSA ABLOY Access and Egress Hardware Group, Inc. All rights reserved. Reproduction in whole or in part without the express written permission of ASSA ABLOY Access and Egress Hardware Group, Inc. is prohibited. Patent pending and/or patent www.assaabloydss.com/patents.

Storeroom or Closet

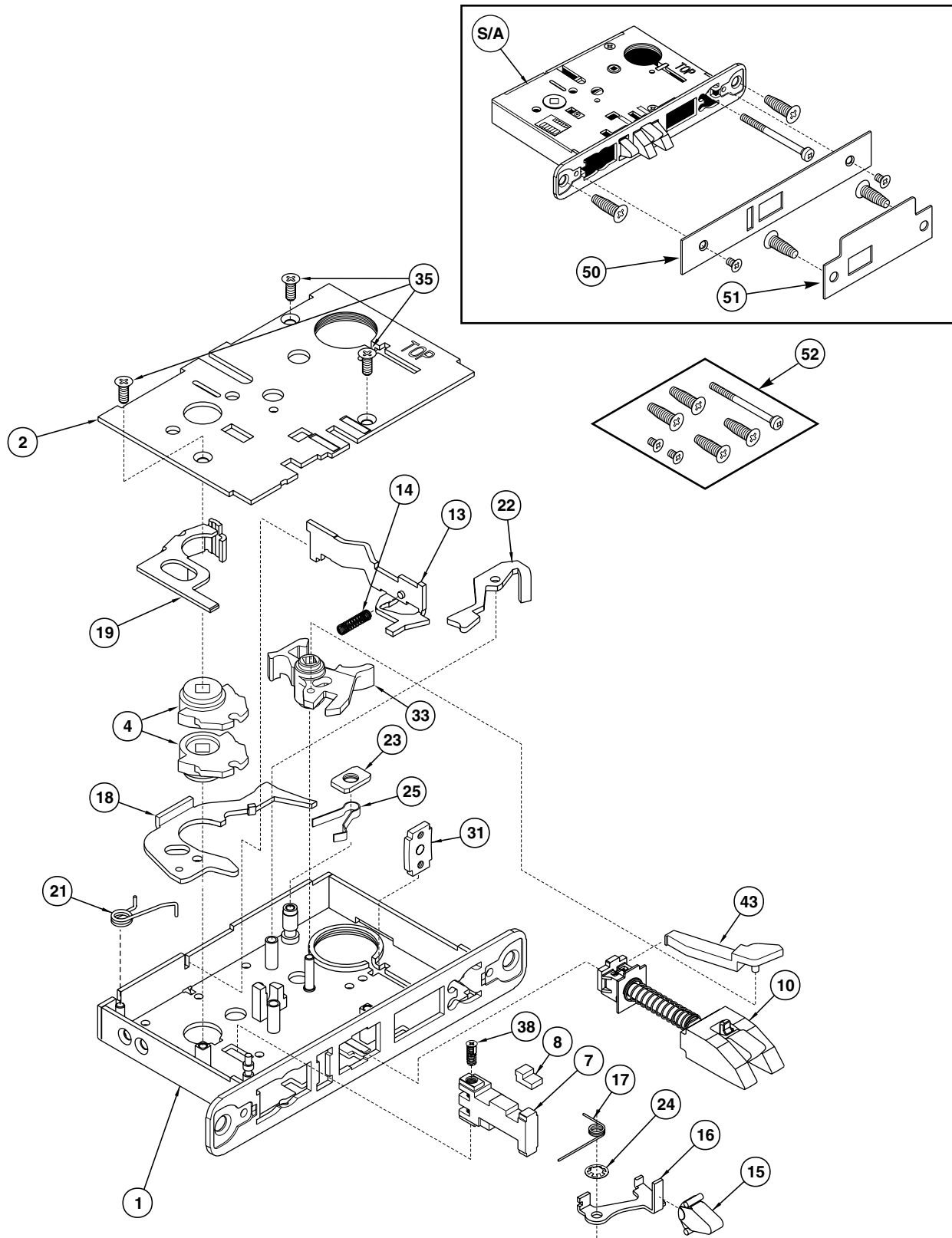

The warranty on Corbin Russwin products becomes void if the product is modified in any way, regardless of whether the modifications causes or contributes to any alleged defect. If a Corbin Russwin product is modified it may no longer meet industry certification and quality control standards applicable to the original product and is no longer a genuine Corbin Russwin product.

Copyright © 2000-2020, ASSA ABLOY Access and Egress Hardware Group, Inc. All rights reserved. Reproduction in whole or in part without the express written permission of ASSA ABLOY Access and Egress Hardware Group, Inc. is prohibited. Patent pending and/or patent www.assaabloydss.com/patents.

Privacy

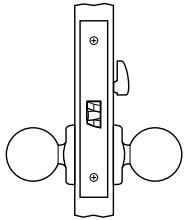

	For 1-3/4" Min. Doors	For 1-3/8" Doors
Type	Standard Master Ring	1" Front
Function	ML2060 -----	D138 Option

Item	Part No.	Description
S/A	701F78-8*	Knob Lock Body (No Cylinder or Trim) for Standard
	701F79-8*	D138 Option
1	687F55-8*	Case & Front Sub Assembly for Standard
	687F56-8*	D138 Option
2	700F27-8*	Cap, Case for Standard
3	682F01-8*	Lever, Sub Assembly, Stop
4	684F14-7	Hub, Knob
7	684F05-5	Stop
9	624F45-5	Hub, Turnpiece
10	688F17-7	Latchbolt Sub Assembly
18	681F37-8*	Lever, Hub
19	688F03-8**	Retractor
21	565F04-8**	Spring, Hub Lever

Item	Part No.	Description
35	684F18-8**	Screw, FHUM-PH-TITE #8-32 x 3/8"
38	684F06-7	Screw, Stop
44	624F42-7	Spring
45	624F43-9	Spacer
46	624F44-9	Spacer
47	688F01-7	Spring, Kick off
50	<i>Specify Finish</i> 423F55	Armored Front for Standard
	423F58	D138 Option
51	236L73 018	Std. Strike (See page 76 for options)
52	<i>Specify Finish</i> 429F41	Mortise Lock Mounting Packet for Standard
	465F57	High Security (M04) (See page 109 for packet descriptions)

*For M26 Option, replace suffix "-8" with "-2".
 **For M26 Option, replace suffix "-8" with "-7".

The warranty on Corbin Russwin products becomes void if the product is modified in any way, regardless of whether the modifications causes or contributes to any alleged defect. If a Corbin Russwin product is modified it may no longer meet industry certification and quality control standards applicable to the original product and is no longer a genuine Corbin Russwin product.

Copyright © 2000-2020, ASSA ABLOY Access and Egress Hardware Group, Inc. All rights reserved. Reproduction in whole or in part without the express written permission of ASSA ABLOY Access and Egress Hardware Group, Inc. is prohibited. Patent pending and/or patent www.assaabloydss.com/patents.

Privacy

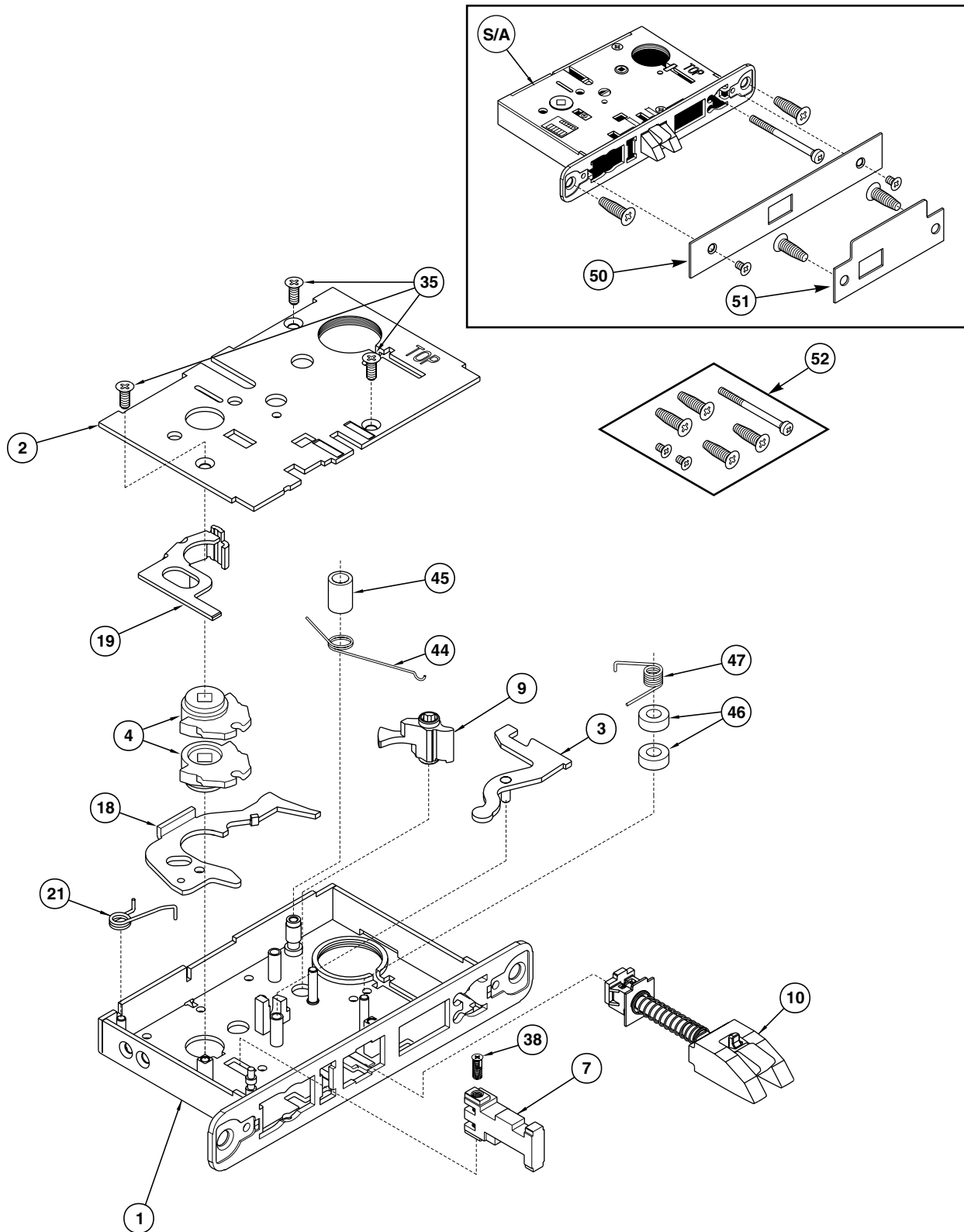

The warranty on Corbin Russwin products becomes void if the product is modified in any way, regardless of whether the modifications causes or contributes to any alleged defect. If a Corbin Russwin product is modified it may no longer meet industry certification and quality control standards applicable to the original product and is no longer a genuine Corbin Russwin product.

Copyright © 2000-2020, ASSA ABLOY Access and Egress Hardware Group, Inc. All rights reserved. Reproduction in whole or in part without the express written permission of ASSA ABLOY Access and Egress Hardware Group, Inc. is prohibited. Patent pending and/or patent www.assaabloydss.com/patents.

Apartment or Dormitory

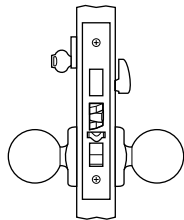

	For 1-3/4" Min. Doors		For 1-3/8" Doors	
Type	Standard	Master Ring	High Security	1" Front
Function	ML2067	MR Option	ML2067HS	D138 Option

Item	Part No.	Description
S/A		Knob Lock Body (No Cylinder or Trim) for
	701F01-8*	Standard
	701F11-8*	D138 Option
	711F01-8	MR Option
	792F01-8	High Security
1		Case & Front Sub Assembly for
	687F53-8*	Standard
	687F54-8*	D138 Option
	687F58-8	MR Option
2		Cap, Case for
	700F27-8*	Standard
	700F57-8*	MR Option
3	682F01-8*	Lever, Sub Assembly, Stop
4		Hub, Knob
	684F14-7	Standard
	683F33-7	High Security
7	684F05-5	Stop
9		Hub, Turnpiece for
	813F505	Standard
	700F31-5	MR Option
10	688F17-7	Latchbolt Sub Assembly
11	702F98-7	Deadbolt
12	701F22-8**	Spring, Deadbolt
13	602F19-8*	Lever, Deadlocking
14	700F90-7	Spring, Deadlocking Lever
15	403F67-7	Latch, Auxiliary
16	678F54-8*	Lever, Auxiliary
17	678F67-7	Spring, Auxiliary Lever
18	681F37-8*	Lever, Hub
19	688F03-8**	Retractor
21	565F04-8**	Spring, Hub Lever

Item	Part No.	Description
22	701F748	Lever, Cylinder Latch
24	436F17-7	Ring, Retaining
26	461F01-2	Toggle Sub Assembly
27	402F63-7	Spring, Toggle
28	402F61-7	Spring, Seat
31	402F73-8	Bracket, Cylinder Set Screw
35	684F18-8**	Screw, FHUM-PH-TITE #8-32 x 3/8"
38	684F06-7	Screw, Stop
50	<i>Specify Finish</i>	Armored Front for
	402F29	Standard
	402F33	D138 Option
51	236L73 018	Std. Strike (See page 76 for options)
52	<i>Specify Finish</i>	Mortise Lock Mounting Packet for
	429F41	Standard
	488F09	High Security (M04)
	465F57	MR x M04
	616F12	(See page 109 for packet descriptions)
53	700F95-7	Spring, Latch Lever

*For M26 Option, replace suffix "-8" with "-2".

**For M26 Option, replace suffix "-8" with "-7".

The warranty on Corbin Russwin products becomes void if the product is modified in any way, regardless of whether the modifications causes or contributes to any alleged defect. If a Corbin Russwin product is modified it may no longer meet industry certification and quality control standards applicable to the original product and is no longer a genuine Corbin Russwin product.

Copyright © 2000-2020, ASSA ABLOY Access and Egress Hardware Group, Inc. All rights reserved. Reproduction in whole or in part without the express written permission of ASSA ABLOY Access and Egress Hardware Group, Inc. is prohibited. Patent pending and/or patent www.assaabloydss.com/patents.

Apartment or Dormitory

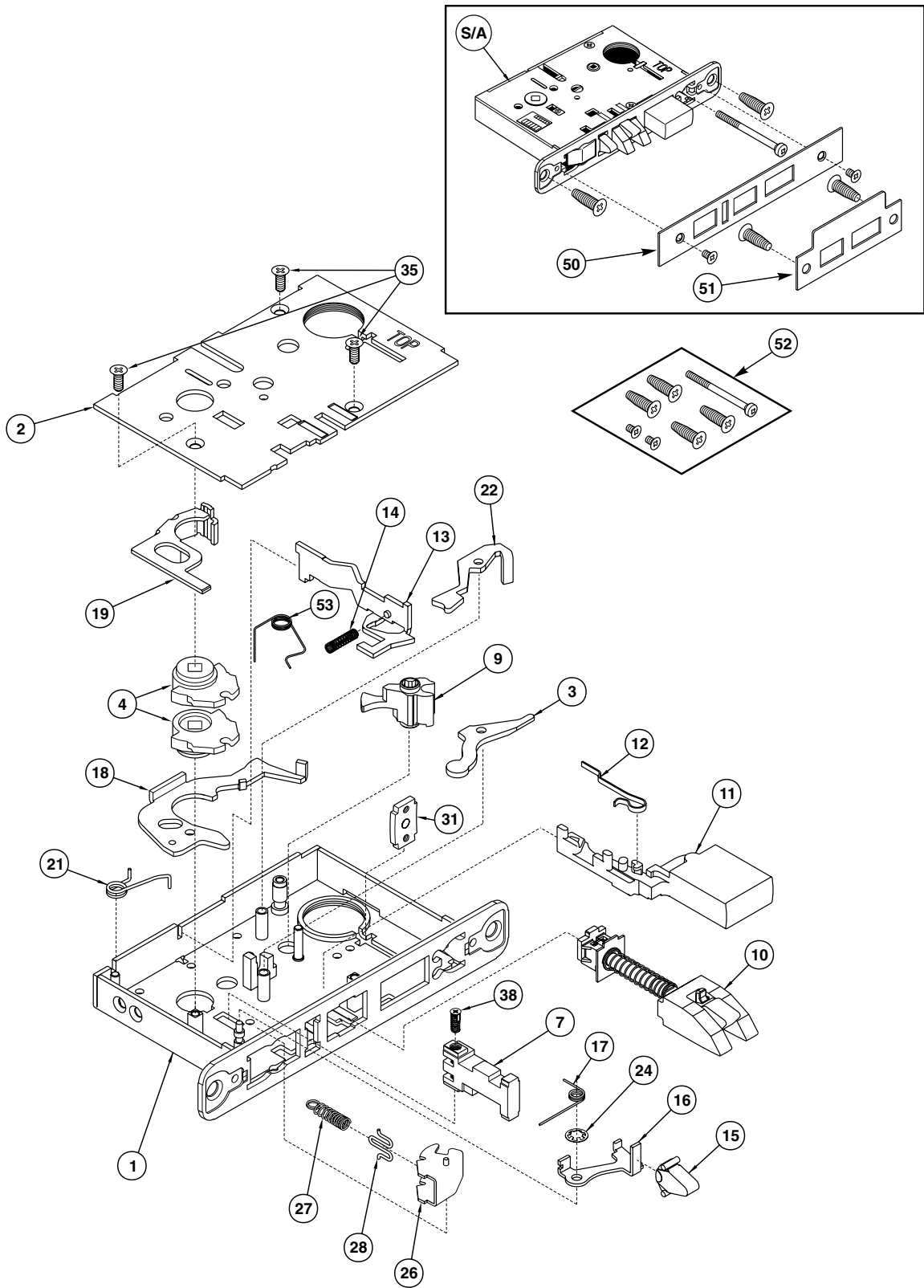

The warranty on Corbin Russwin products becomes void if the product is modified in any way, regardless of whether the modifications causes or contributes to any alleged defect. If a Corbin Russwin product is modified it may no longer meet industry certification and quality control standards applicable to the original product and is no longer a genuine Corbin Russwin product.

Copyright © 2000-2020, ASSA ABLOY Access and Egress Hardware Group, Inc. All rights reserved. Reproduction in whole or in part without the express written permission of ASSA ABLOY Access and Egress Hardware Group, Inc. is prohibited. Patent pending and/or patent www.assaabloydss.com/patents.

Institutional Privacy

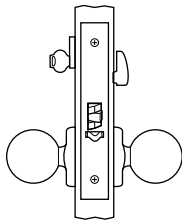

	For 1-3/4" Min. Doors		For 1-3/8" Doors	
Type	Standard	Master Ring	High Security	1" Front
Function	ML2069	MR Option	ML2069HS	D138 Option

Item	Part No.	Description
S/A		Knob Lock Body (No Cylinder or Trim) for
	701F52-8*	Standard
	701F59-8*	D138 Option
1		Case & Front Sub Assembly for
	687F55-8*	Standard
	687F56-8*	D138 Option
2	700F27-8*	Cap, Case
3	624F47-8	Lever, Stop
4		Hub, Knob
	684F14-7	Standard
	683F33-7	High Security
7	684F05-5	Stop
9	624F45-5	Hub, Turnpiece
10	688F17-7	Latchbolt Sub Assembly
13	624F48-8*	Lever, Deadlocking
14	700F90-7	Spring, Deadlocking Lever
15	403F67-7	Latch, Auxiliary
16	678F54-8*	Lever, Auxiliary
17	678F67-7	Spring, Auxiliary Lever
18	681F37-8*	Lever, Hub
19	688F03-8**	Retractor
21	565F04-8**	Spring, Hub Lever

Item	Part No.	Description
22	688F14-8*	Lever, Cylinder Latch
23	681F48-9	Stop, Cylinder Latch Lever
24	436F17-7	Ring, Retaining
31	402F73-8	Bracket, Cylinder Set Screw
35	684F18-8**	Screw, FHUM-PH-TITE #8-32 x 3/8"
38	684F06-7	Screw, Stop
44	624F42-7	Spring
45	624F43-9	Spacer
46	624F44-9	Spacer
47	688F01-7	Spring, Kick off
50	<i>Specify Finish</i>	Armored Front for
	624F49	Standard
	624F53	D138 Option
51	236L73 018	Std. Strike (See page 76 for options)
52	<i>Specify Finish</i>	Mortise Lock Mounting Packet for
	429F41	Standard
	465F57	High Security (M04)

*For M26 Option, replace suffix "-8" with "-2".

**For M26 Option, replace suffix "-8" with "-7".

The warranty on Corbin Russwin products becomes void if the product is modified in any way, regardless of whether the modifications causes or contributes to any alleged defect. If a Corbin Russwin product is modified it may no longer meet industry certification and quality control standards applicable to the original product and is no longer a genuine Corbin Russwin product.

Copyright © 2000-2020, ASSA ABLOY Access and Egress Hardware Group, Inc. All rights reserved. Reproduction in whole or in part without the express written permission of ASSA ABLOY Access and Egress Hardware Group, Inc. is prohibited. Patent pending and/or patent www.assaabloydss.com/patents.

Institutional Privacy

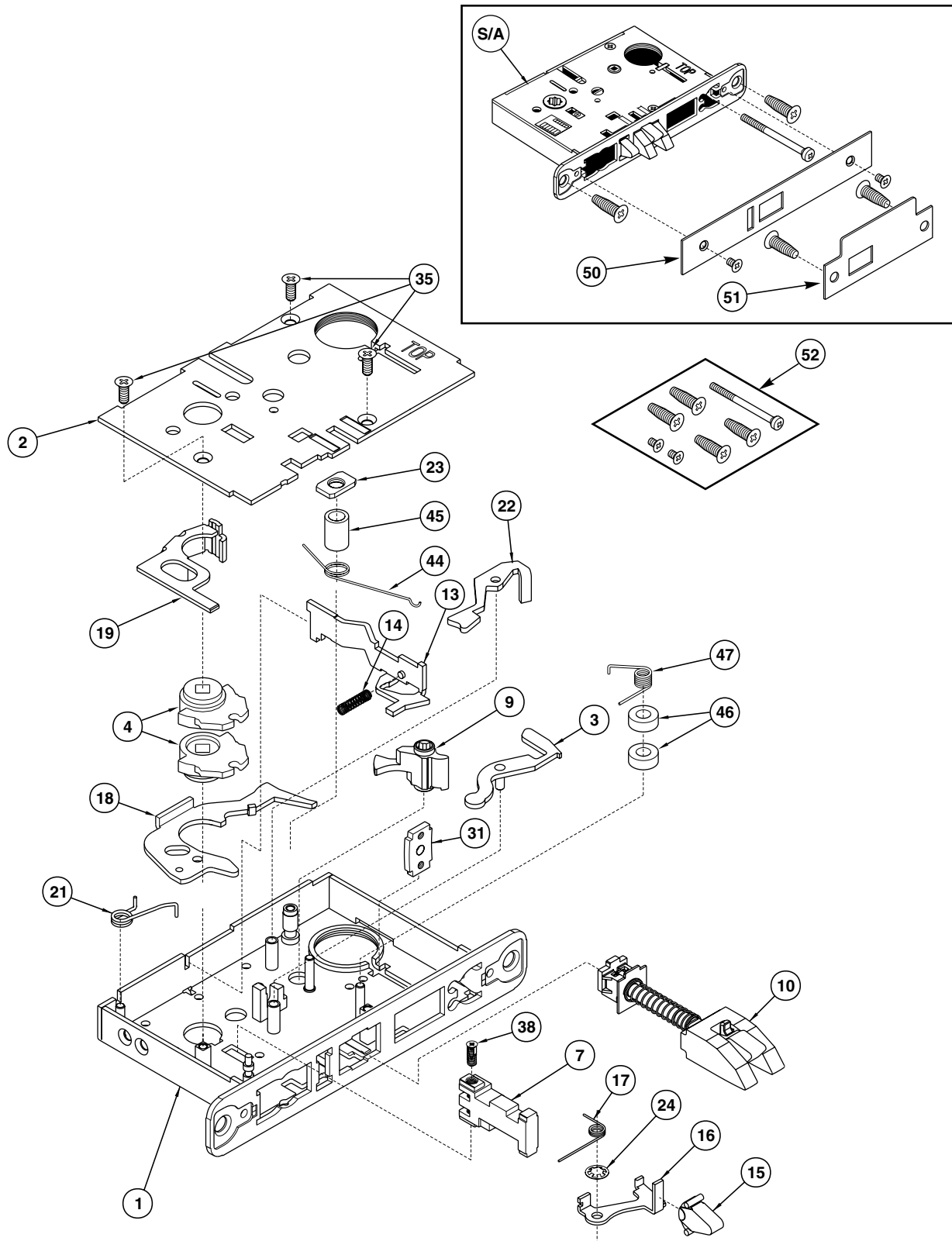

The warranty on Corbin Russwin products becomes void if the product is modified in any way, regardless of whether the modifications causes or contributes to any alleged defect. If a Corbin Russwin product is modified it may no longer meet industry certification and quality control standards applicable to the original product and is no longer a genuine Corbin Russwin product.

Copyright © 2000-2020, ASSA ABLOY Access and Egress Hardware Group, Inc. All rights reserved. Reproduction in whole or in part without the express written permission of ASSA ABLOY Access and Egress Hardware Group, Inc. is prohibited. Patent pending and/or patent www.assaabloydss.com/patents.

Classroom Security

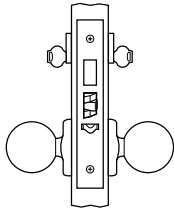

	For 1-3/4" Min. Doors		For 1-3/8" Doors	
Type	Standard	Master Ring	High Security	1" Front
Function	ML2072	MR Option	ML2072HS	D138 Option

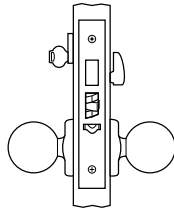

	For 1-3/4" Min. Doors		For 1-3/8" Doors	
Type	Standard	Master Ring	High Security	1" Front
Function	ML2075	MR Option	ML2075HS	D138 Option

Item	Part No.	Description
S/A		Knob Lock Body (No Cylinder or Trim) for
	701F75-8*	Standard
	701F85-8*	D138 Option
	711F75-8	MR Option
	792F75-8	High Security
1		Case & Front Sub Assembly for
	687F53-8*	Standard
	687F54-8*	D138 Option
	687F58-8*	MR Option
2		Cap, Case For
	700F27-8*	Standard
	700F57-8*	MR Option
3	700F25-8	Lever, Stop
4		Hub, Knob
	684F14-7	Standard
	683F33-7	High Security
7	684F05-5	Stop
9		Hub, Turnpiece
	700F23-5	Standard
	700F31-5	MR Option
10	688F17-7	Latchbolt Sub Assembly
11	702F98-7	Deadbolt
12	701F22-8**	Spring, Deadbolt
13	700F21-8*	Lever, Deadlocking
14	700F90-7	Spring, Deadlocking Lever
15	403F67-7	Latch, Auxiliary

Item	Part No.	Description
16	678F54-8*	Lever, Auxiliary
17	678F67-7	Spring, Auxiliary Lever
18	681F36-8*	Lever, Hub
19	688F03-8**	Retractor
21	565F04-8**	Spring, Hub Lever
22	700F22-8*	Lever, Cylinder Latch
24	436F17-7	Ring, Retaining
31	402F73-8	Bracket, Cylinder Set Screw
35	684F18-8**	Screw, FHUM-PH-TITE #8-32 x 3/8"
38	684F06-7	Screw, Stop
50	<i>Specify Finish</i>	Armored Front for
	402F30	Standard
	402F34	D138 Option
51	236L73 018	Std. Strike (See page 76 for options)
52	<i>Specify Finish</i>	Mortise Lock Mounting Packet for
	429F41	Standard
	488F09	MR Option
	465F57	High Security (M04)
	616F12	MR & M04 (See page 109 for packet descriptions) NOTE: For double cylinder functions an additional cylinder set screw is required.)
		Cylinder Set Screw for
	488F08-8	Standard & High Security
	488F10-8	MR Option
53	700F95-7	Spring, Latch Lever
54	703F99-7	Spring, Stop

*For M26 Option, replace suffix "-8" with "-2".
 **For M26 Option, replace suffix "-8" with "-7".

The warranty on Corbin Russwin products becomes void if the product is modified in any way, regardless of whether the modifications causes or contributes to any alleged defect. If a Corbin Russwin product is modified it may no longer meet industry certification and quality control standards applicable to the original product and is no longer a genuine Corbin Russwin product.

Copyright © 2000-2020, ASSA ABLOY Access and Egress Hardware Group, Inc. All rights reserved. Reproduction in whole or in part without the express written permission of ASSA ABLOY Access and Egress Hardware Group, Inc. is prohibited. Patent pending and/or patent www.assaabloydss.com/patents.



Classroom Security

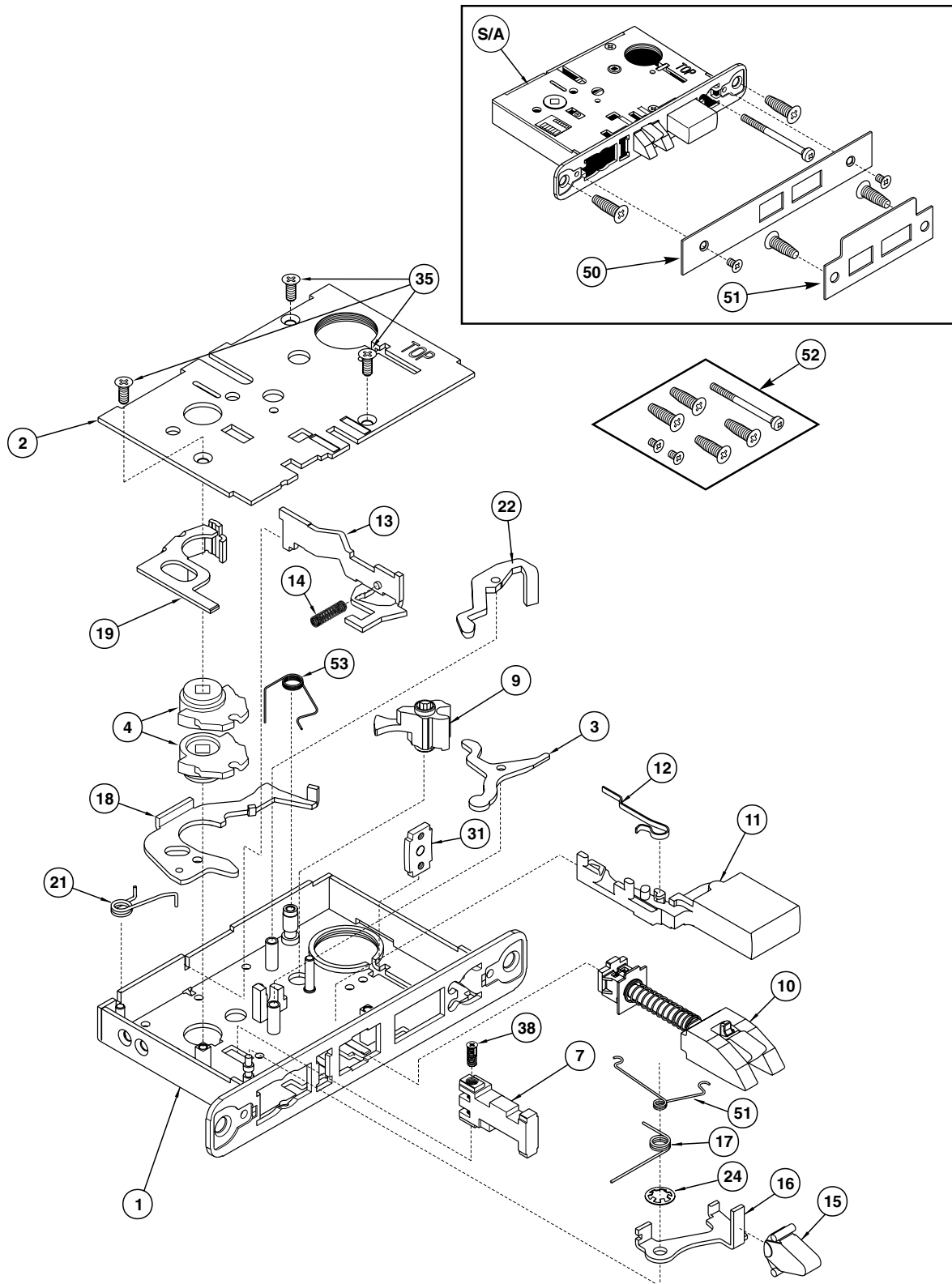

The warranty on Corbin Russwin products becomes void if the product is modified in any way, regardless of whether the modifications causes or contributes to any alleged defect. If a Corbin Russwin product is modified it may no longer meet industry certification and quality control standards applicable to the original product and is no longer a genuine Corbin Russwin product.

Copyright © 2000-2020, ASSA ABLOY Access and Egress Hardware Group, Inc. All rights reserved. Reproduction in whole or in part without the express written permission of ASSA ABLOY Access and Egress Hardware Group, Inc. is prohibited. Patent pending and/or patent www.assaabloydss.com/patents.

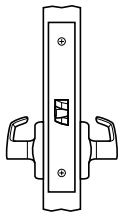

Passage or Closet ANSI F01 PG 42

	For 1-3/4" Min. Doors	For 1-3/8" Doors	
Type	Standard Master Ring	1" Front	Vandal Resistant
Function	ML2010 -----	D138 Option	ML2010VR

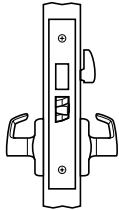

Privacy Bedroom or Bathroom ANSI F02 PG 44

	For 1-3/4" Min. Doors	For 1-3/8" Doors	
Type	Standard Master Ring	1" Front	Vandal Resistant
Function	ML2020 -----	D138 Option	ML2020VR

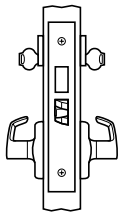

Store Door ANSI F14 PG 44

	For 1-3/4" Min. Doors	For 1-3/8" Doors	
Type	Standard Master Ring	1" Front	Vandal Resistant
Function	ML2022 MR Option	D138 Option	ML2022VR

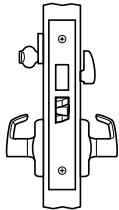

Entrance or Storeroom ANSI F21 PG 44

	For 1-3/4" Min. Doors	For 1-3/8" Doors	
Type	Standard Master Ring	1" Front	Vandal Resistant
Function	ML2024 MR Option	D138 Option	ML2024VR

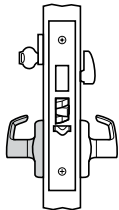

Hotel or Motel ANSI F15 PG 46

	For 1-3/4" Min. Doors	For 1-3/8" Doors	
Type	Standard Master Ring	1" Front	Vandal Resistant
Function	ML2029 -----	D138 Option	ML2029VR

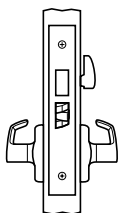

Privacy, Bedroom or Bathroom ANSI F19 PG 48

	For 1-3/4" Min. Doors	For 1-3/8" Doors	
Type	Standard Master Ring	1" Front	Vandal Resistant
Function	ML2030 -----	D138 Option	ML2030VR

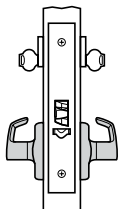

Institution or Utility PG 50

	For 1-3/4" Min. Doors	For 1-3/8" Doors	
Type	Standard Master Ring	1" Front	Vandal Resistant
Function	ML2032 -----	D138 Option	ML2032VR

The warranty on Corbin Russwin products becomes void if the product is modified in any way, regardless of whether the modifications causes or contributes to any alleged defect. If a Corbin Russwin product is modified it may no longer meet industry certification and quality control standards applicable to the original product and is no longer a genuine Corbin Russwin product.

Copyright © 2000-2020, ASSA ABLOY Access and Egress Hardware Group, Inc. All rights reserved. Reproduction in whole or in part without the express written permission of ASSA ABLOY Access and Egress Hardware Group, Inc. is prohibited. Patent pending and/or patent www.assaabloydss.com/patents.

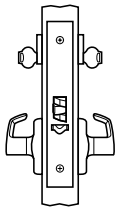
**Entrance or Public Restroom ANSI F09 PG 52**

	For 1-3/4" Min. Doors	For 1-3/8" Doors	
Type	Standard Master Ring	1" Front	Vandal Resistant
Function	ML2042 MR Option	D138 Option	ML2042VR

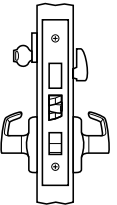
**Entrance or Apartment ANSI F10 PG 54**

	For 1-3/4" Min. Doors	For 1-3/8" Doors	
Type	Standard Master Ring	1" Front	Vandal Resistant
Function	ML2048 MR Option	D138 Option	ML2048VR

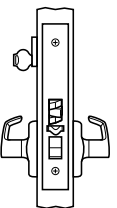
**Entrance or Office ANSI F04 PG 56**

	For 1-3/4" Min. Doors	For 1-3/8" Doors	
Type	Standard Master Ring	1" Front	Vandal Resistant
Function	ML2051 MR Option	D138 Option	ML2051VR

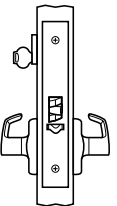
**Classroom ANSI F05 PG 52**

	For 1-3/4" Min. Doors	For 1-3/8" Doors	
Type	Standard Master Ring	1" Front	Vandal Resistant
Function	ML2055 MR Option	D138 Option	ML2055VR

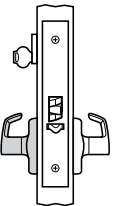
**Storeroom or Closet ANSI F07 PG 58**

	For 1-3/4" Min. Doors	For 1-3/8" Doors	
Type	Standard Master Ring	1" Front	Vandal Resistant
Function	ML2057 MR Option	D138 Option	ML2057VR

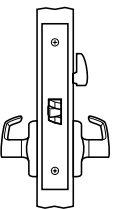
**Privacy ANSI F22 PG 60**

	For 1-3/4" Min. Doors	For 1-3/8" Doors	
Type	Standard Master Ring	1" Front	Vandal Resistant
Function	ML2060 MR Option	D138 Option	ML2060VR

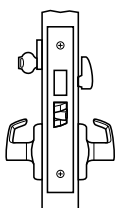
**Dormitory, Entrance or Storeroom ANSI F13 PG 48**

	For 1-3/4" Min. Doors	For 1-3/8" Doors	
Type	Standard Master Ring	1" Front	Vandal Resistant
Function	ML2065 MR Option	D138 Option	ML2065VR

The warranty on Corbin Russwin products becomes void if the product is modified in any way, regardless of whether the modifications causes or contributes to any alleged defect. If a Corbin Russwin product is modified it may no longer meet industry certification and quality control standards applicable to the original product and is no longer a genuine Corbin Russwin product.

Copyright © 2000-2020, ASSA ABLOY Access and Egress Hardware Group, Inc. All rights reserved. Reproduction in whole or in part without the express written permission of ASSA ABLOY Access and Egress Hardware Group, Inc. is prohibited. Patent pending and/or patent www.assaabloydss.com/patents.

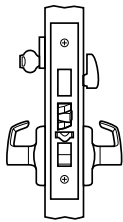

Apartment or Dormitory ANSI F12 PG 62

	For 1-3/4" Min. Doors	For 1-3/8" Doors	
Type	Standard Master Ring	1" Front	Vandal Resistant
Function	ML2067 MR Option	D138 Option	ML2067VR

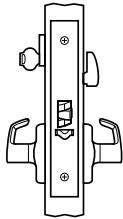

Institutional Privacy PG 56

	For 1-3/4" Min. Doors	For 1-3/8" Doors	
Type	Standard Master Ring	1" Front	Vandal Resistant
Function	ML2069 -----	D138 Option	ML2069VR

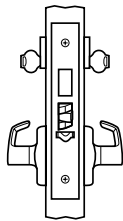

Classroom Security PG 66

	For 1-3/4" Min. Doors	For 1-3/8" Doors	
Type	Standard Master Ring	1" Front	Vandal Resistant
Function	ML2072 MR Option	D138 Option	ML2072VR

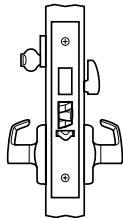

Classroom Security PG 66

	For 1-3/4" Min. Doors	For 1-3/8" Doors	
Type	Standard Master Ring	1" Front	Vandal Resistant
Function	ML2075 MR Option	D138 Option	ML2075VR

The warranty on Corbin Russwin products becomes void if the product is modified in any way, regardless of whether the modifications causes or contributes to any alleged defect. If a Corbin Russwin product is modified it may no longer meet industry certification and quality control standards applicable to the original product and is no longer a genuine Corbin Russwin product.

Copyright © 2000-2020, ASSA ABLOY Access and Egress Hardware Group, Inc. All rights reserved. Reproduction in whole or in part without the express written permission of ASSA ABLOY Access and Egress Hardware Group, Inc. is prohibited. Patent pending and/or patent www.assaabloydss.com/patents.



Passage or Closet

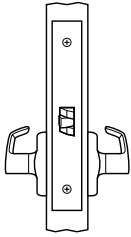

	For 1-3/4" Min. Doors		For 1-3/8" Doors
Type	Standard	Master Ring	Vandal Resistant
Function	ML2010	-----	ML2010VR
			1" Front
			D138 Option

Item	Part No.	Description
S/A	700F10-8* 700F20-8*	Lever Lock Body (No Cylinder or Trim) for Standard & Vandal Resistant D138 Option
1	687F53-8* 687F54-8*	Case & Front Sub Assembly for Standard D138 Option
2	700F27-8*	Cap, Case
5	684F10-8** 684F10-7	Hub (Case Side) Standard Vandal Resistant
6	684F09-8** 684F09-7	Hub (Case Side) Standard Vandal Resistant
10	688F17-7	Latchbolt Sub Assembly
18	681F36-8*	Lever, Hub
19	688F03-8**	Retractor
20	690F82-7	Spring, Retractor
21	814F218**	Spring, Hub Lever
29	466F22-9	Spacer

Item	Part No.	Description
30	404F85-8**	Spring, Lever Return
32	404F86-8*	Bracket, Align
35	684F18-8**	Screw, FHUM-PH-TITE #8-32 x 3/8"
36	684F11-9	Spacer, Hub
37	684F12-9	Spacer, Spring
38	684F06-7	Screw, Stop
50	<i>Specify Finish</i> 423F55 423F58	Armored Front for Standard D138 Option
51	236L73 018	Std. Strike (See page 76 for options)
52	<i>Specify Finish</i> 429F41 465F57	Mortise Lock Mounting Packet Vandal Resistant & M04 (See page 109 for packet descriptions)

*For M26 Option, replace suffix "-8" with "-2".
**For M26 Option, replace suffix "-8" with "-7".

The warranty on Corbin Russwin products becomes void if the product is modified in any way, regardless of whether the modifications causes or contributes to any alleged defect. If a Corbin Russwin product is modified it may no longer meet industry certification and quality control standards applicable to the original product and is no longer a genuine Corbin Russwin product.

Copyright © 2000-2020, ASSA ABLOY Access and Egress Hardware Group, Inc. All rights reserved. Reproduction in whole or in part without the express written permission of ASSA ABLOY Access and Egress Hardware Group, Inc. is prohibited. Patent pending and/or patent www.assaabloydss.com/patents.



Passage or Closet

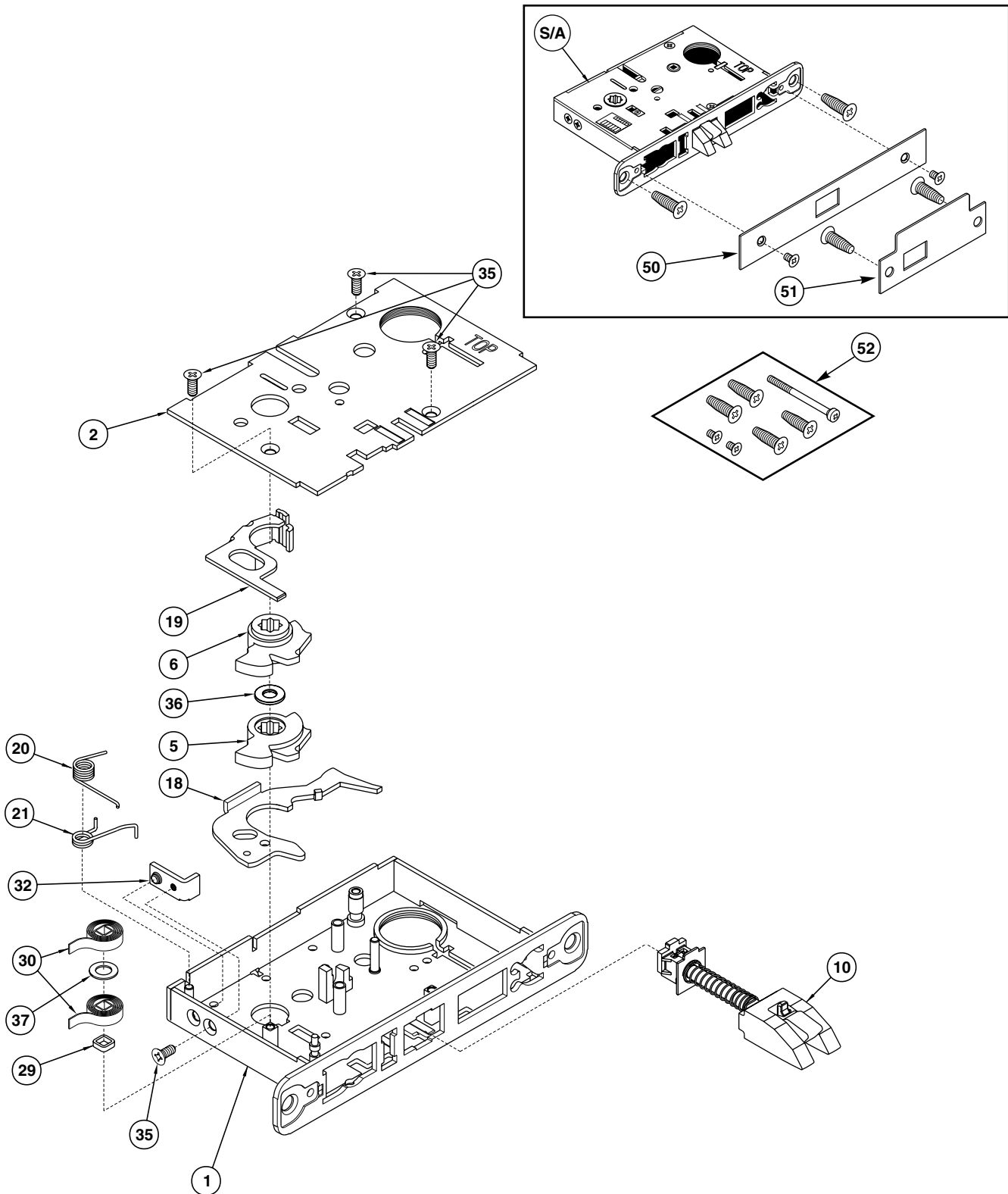

The warranty on Corbin Russwin products becomes void if the product is modified in any way, regardless of whether the modifications causes or contributes to any alleged defect. If a Corbin Russwin product is modified it may no longer meet industry certification and quality control standards applicable to the original product and is no longer a genuine Corbin Russwin product.

Copyright © 2000-2020, ASSA ABLOY Access and Egress Hardware Group, Inc. All rights reserved. Reproduction in whole or in part without the express written permission of ASSA ABLOY Access and Egress Hardware Group, Inc. is prohibited. Patent pending and/or patent www.assaabloydss.com/patents.

Privacy, Bedroom or Bathroom, Store Door, Entrance or Storeroom

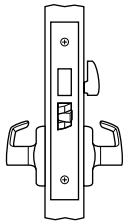

	For 1-3/4" Min. Doors			For 1-3/8" Doors
Type	Standard	Master Ring	Vandal Resistant	1" Front
Function	ML2020	-----	ML2020VR	D138 Option

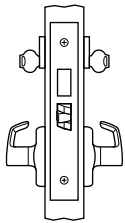

	For 1-3/4" Min. Doors			For 1-3/8" Doors
Type	Standard	Master Ring	Vandal Resistant	1" Front
Function	ML2022	MR Option	ML2022VR	D138 Option

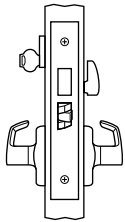

	For 1-3/4" Min. Doors			For 1-3/8" Doors
Type	Standard	Master Ring	Vandal Resistant	1" Front
Function	ML2024	MR Option	ML2024VR	D138 Option

Item	Part No.	Description
S/A	700F05-8*	Lever Lock Body (No Cylinder or Trim) for Standard & Vandal Resistant
	700F15-8*	D138 Option
	710F05-8*	MR Option
1	687F53-8*	Case & Front Sub Assembly for Standard
	687F54-8*	D138 Option
	687F58-8*	MR Option
2	700F27-8*	Cap, Case for Standard
	700F57-8*	MR Option
5	684F10-8**	Hub (Case Side) Standard
	684F10-7	Vandal Resistant
6	684F09-8**	Hub (Case Side) Standard
	684F09-7	Vandal Resistant
7	684F05-5	Stop
9	813F505	Hub, Turnpiece for Standard
	700F31-5	MR Option

Item	Part No.	Description
10	688F17-7	Latchbolt Sub Assembly
11	702F98-7	Deadbolt
12	701F22-8**	Spring, Deadbolt
18	681F36-8*	Lever, Hub
19	688F03-8**	Retractor
20	690F82-7	Spring, Retractor
21	565F04-8**	Spring, Hub Lever
22	701F748	Lever Sub Assembly, Cylinder Latch
29	466F22-9	Spacer
30	404F85-8**	Spring, Lever Return
31	402F73-8*	Bracket, Cylinder Set Screw
32	404F86-8*	Bracket, Align
35	684F18-8**	Screw, FHUM-PH-TITE #8-32 x 3/8"
36	684F11-9	Spacer, Hub
37	684F12-9	Spacer, Spring
38	684F067	Stop Screw
50	<i>Specify Finish</i>	Armored Front for
	423F54	Standard
	423F57	D138 Option

*For M26 Option, replace suffix "-8" with "-2".
 **For M26 Option, replace suffix "-8" with "-7".

The warranty on Corbin Russwin products becomes void if the product is modified in any way, regardless of whether the modifications causes or contributes to any alleged defect. If a Corbin Russwin product is modified it may no longer meet industry certification and quality control standards applicable to the original product and is no longer a genuine Corbin Russwin product.

Copyright © 2000-2020, ASSA ABLOY Access and Egress Hardware Group, Inc. All rights reserved. Reproduction in whole or in part without the express written permission of ASSA ABLOY Access and Egress Hardware Group, Inc. is prohibited. Patent pending and/or patent www.assaabloydss.com/patents.

Privacy, Bedroom or Bathroom, Store Door, Entrance or Storeroom



Item	Part No.	Description
51	236L72 018	Std. Strike (See page 76 for options)
52	<i>Specify Finish</i>	Mortise Lock Mounting Packet For
	429F41	Standard
	488F09	MR Option
	465F57	Vandal Resistant & M04
	616F12	MR x M04 (See page 109 for packet descriptions) NOTE: For double cylinder functions an additional cylinder screw is required.
	488F08-8	Standard
	488F10-8	MR Option
53	700F95-7	Spring, Latch Lever

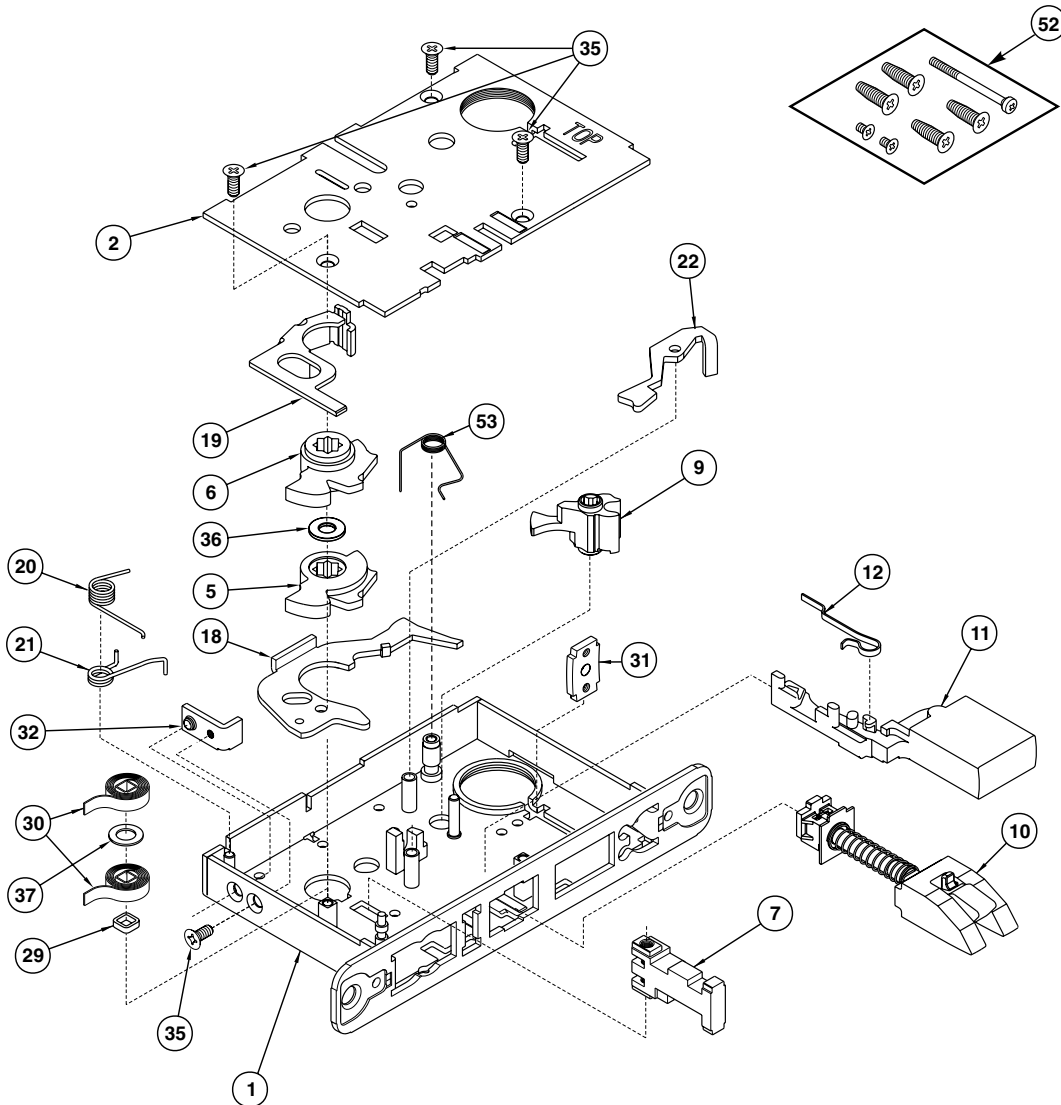
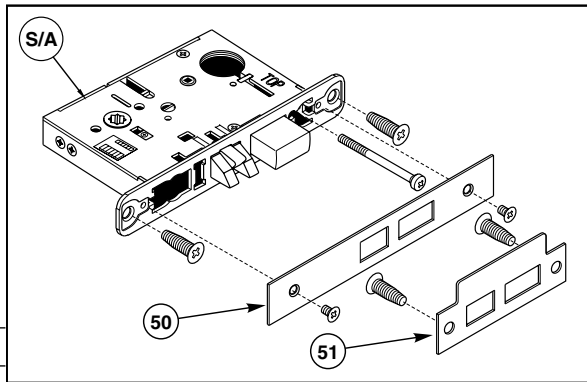

The warranty on Corbin Russwin products becomes void if the product is modified in any way, regardless of whether the modifications causes or contributes to any alleged defect. If a Corbin Russwin product is modified it may no longer meet industry certification and quality control standards applicable to the original product and is no longer a genuine Corbin Russwin product.

Copyright © 2000-2020, ASSA ABLOY Access and Egress Hardware Group, Inc. All rights reserved. Reproduction in whole or in part without the express written permission of ASSA ABLOY Access and Egress Hardware Group, Inc. is prohibited. Patent pending and/or patent www.assaabloydss.com/patents.



Hotel or Motel

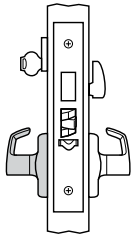

	For 1-3/4" Min. Doors			For 1-3/8" Doors
Type	Standard	Master Ring	Vandal Resistant	1" Front
Function	ML2029	-----	ML2029VR	D138 Option

Item	Part No.	Description
S/A		Lever Lock Body (No Cylinder or Trim) for
	700F03-8*	Standard
	700F13-8*	D138 Option
	703F03-8*	Vandal Resistant
1		Case & Front Sub Assembly for
	687F53-8*	Standard
	687F54-8*	D138 Option
2	700F27-8*	Cap, Case
5		Hub (Case Side)
	684F10-8**	Standard
	684F10-7	Vandal Resistant
6		Hub (Case Side)
	684F09-8**	Standard
	684F09-7	Vandal Resistant
7	684F05-5	Stop
8	684F55-9	Stop, Fixed
9	700F23-5	Hub, Turnpiece
10	688F17-7	Latchbolt Sub Assembly
11	702F98-7	Deadbolt
12	701F22-8**	Spring, Deadbolt
13	624F48-8*	Lever, Deadlocking
14	700F90-7	Spring, Deadlocking Lever
15	403F67-7	Latch, Auxiliary
16	678F54-8*	Lever, Auxiliary
17	678F67-7	Spring, Auxiliary Lever
18	681F36-8*	Lever, Hub
19	688F03-8**	Retractor
20	690F82-7	Spring, Retractor
21	565F04-8**	Spring, Hub Lever

Item	Part No.	Description
22	688F14-8*	Lever, Cylinder Latch
24	436F17-7	Ring, Retaining
29	466F22-9	Spacer
30	404F85-8**	Spring, Lever Return
31	402F73-8*	Bracket, Cylinder Set Screw
32	404F86-8*	Bracket, Align
35	684F18-8**	Screw, FHUM-PH-TITE #8-32 x 3/8"
36	684F11-9	Spacer, Hub
37	684F12-9	Spacer, Spring
38	684F06-7	Screw, Stop
50	<i>Specify Finish</i>	Armored Front for
	402F30	Standard
	402F34	D138 Option
51	236L72 018	Std. Strike (See page 76 for options)
52	<i>Specify Finish</i>	Mortise Lock Mounting Packet
	429F41	Vandal Resistant & M04 (See page 109 for packet descriptions)
	465F57	
53	700F95-7	Spring, Latch Lever

*For M26 Option, replace suffix "-8" with "-2".

**For M26 Option, replace suffix "-8" with "-7".

The warranty on Corbin Russwin products becomes void if the product is modified in any way, regardless of whether the modifications causes or contributes to any alleged defect. If a Corbin Russwin product is modified it may no longer meet industry certification and quality control standards applicable to the original product and is no longer a genuine Corbin Russwin product.

Copyright © 2000-2020, ASSA ABLOY Access and Egress Hardware Group, Inc. All rights reserved. Reproduction in whole or in part without the express written permission of ASSA ABLOY Access and Egress Hardware Group, Inc. is prohibited. Patent pending and/or patent www.assaabloy.com/patents.



Hotel or Motel

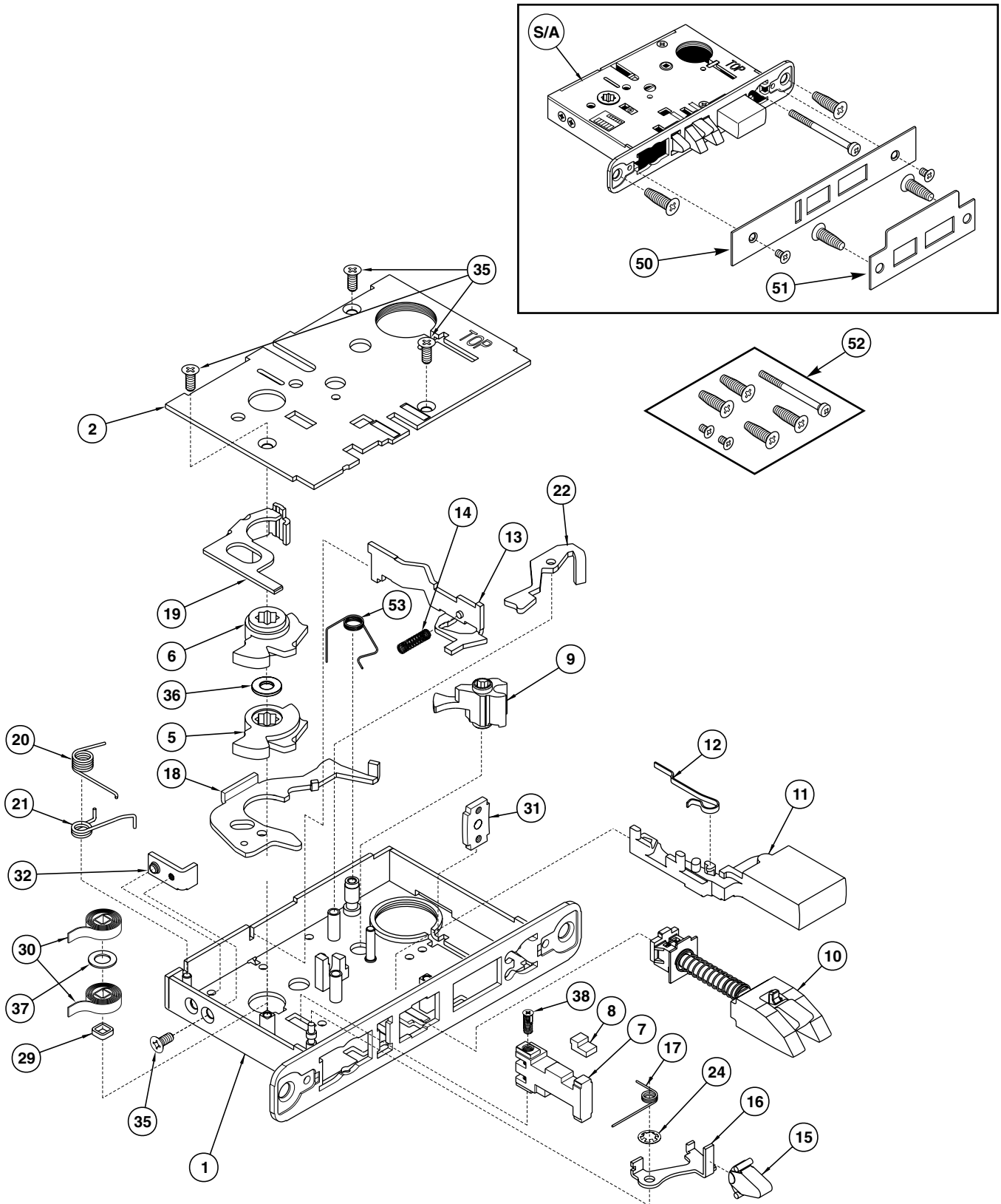

The warranty on Corbin Russwin products becomes void if the product is modified in any way, regardless of whether the modifications causes or contributes to any alleged defect. If a Corbin Russwin product is modified it may no longer meet industry certification and quality control standards applicable to the original product and is no longer a genuine Corbin Russwin product.

Copyright © 2000-2020, ASSA ABLOY Access and Egress Hardware Group, Inc. All rights reserved. Reproduction in whole or in part without the express written permission of ASSA ABLOY Access and Egress Hardware Group, Inc. is prohibited. Patent pending and/or patent www.assaabloydss.com/patents.





Privacy, Bedroom or Bathroom, Dormitory, Entrance or Storeroom

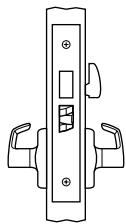

	For 1-3/4" Min. Doors			For 1-3/8" Doors
Type	Standard	Master Ring	Vandal Resistant	1" Front
Function	ML2030	-----	ML2030VR	D138 Option

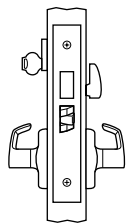

	For 1-3/4" Min. Doors			For 1-3/8" Doors
Type	Standard	Master Ring	Vandal Resistant	1" Front
Function	ML2065	MR Option	ML2065VR	D138 Option

Item	Part No.	Description
S/A		Lever Lock Body (No Cylinder or Trim) for
	700F02-8*	Standard
	700F12-8*	D138 Option
	710F02-8	MR Option
	703F02-8*	Vandal Resistant
1		Case & Front Sub Assembly for
	687F53-8*	Standard
	687F54-8*	D138 Option
	687F58-8*	MR Option
2		Cap, Case for
	700F27-8*	Standard
	700F57-8*	MR Option
3	700F70-8*	Lever, Stop
5		Hub (Case Side)
	684F10-8**	Standard
	684F10-7	Vandal Resistant
6		Hub (Case Side)
	684F09-8**	Standard
	684F09-7	Vandal Resistant
7	684F05-5	Stop
9	700F23-5	Hub, Turnpiece
10	688F17-7	Latchbolt Sub Assembly
11	702F98-7	Deadbolt
12	701F22-8**	Spring, Deadbolt
18	681F36-8*	Lever, Hub

Item	Part No.	Description
19	688F03-8**	Retractor
20	690F82-7	Spring, Retractor
21	565F04-8**	Spring, Hub Lever
22	688F14-8*	Lever, Cylinder Latch
29	466F22-9	Spacer
30	404F85-8**	Spring, Lever Return
31	402F73-8*	Bracket, Cylinder Set Screw
32	404F86-8*	Bracket, Align
35	684F18-8**	Screw, FHUM-PH-TITE #8-32 x 3/8"
36	684F11-9	Spacer, Hub
37	684F12-9	Spacer, Spring
38	684F06-7	Screw, Stop
50	<i>Specify Finish</i>	Armored Front for
	423F54	Standard
	423F57	D138 Option
51	236L72 018	Std. Strike (See page 76 for options)
52	<i>Specify Finish</i>	Mortise Lock Mounting Packet
	429F41	Standard
	488F09	MR Option
	465F57	Vandal Resistant & M04
	616F12	MR x M04 (See page 109 for packet descriptions)
53	700F95-7	Spring, Latch Lever

*For M26 Option, replace suffix "-8" with "-2".
 **For M26 Option, replace suffix "-8" with "-7".

The warranty on Corbin Russwin products becomes void if the product is modified in any way, regardless of whether the modifications causes or contributes to any alleged defect. If a Corbin Russwin product is modified it may no longer meet industry certification and quality control standards applicable to the original product and is no longer a genuine Corbin Russwin product.

Copyright © 2000-2020, ASSA ABLOY Access and Egress Hardware Group, Inc. All rights reserved. Reproduction in whole or in part without the express written permission of ASSA ABLOY Access and Egress Hardware Group, Inc. is prohibited. Patent pending and/or patent www.assaabloydss.com/patents.



Privacy, Bedroom or Bathroom, Dormitory, Entrance or Storeroom

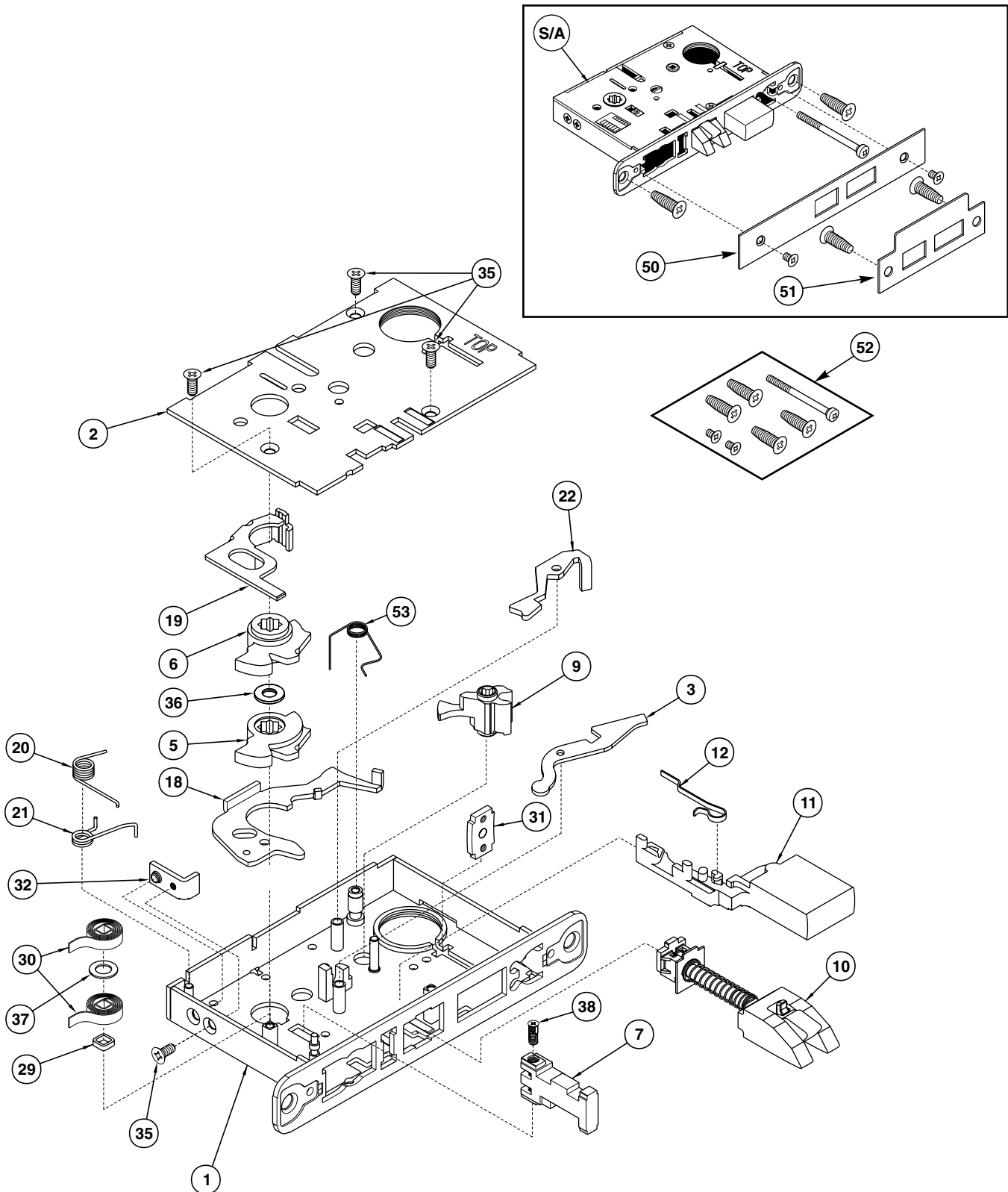

The warranty on Corbin Russwin products becomes void if the product is modified in any way, regardless of whether the modifications causes or contributes to any alleged defect. If a Corbin Russwin product is modified it may no longer meet industry certification and quality control standards applicable to the original product and is no longer a genuine Corbin Russwin product.

Copyright © 2000-2020, ASSA ABLOY Access and Egress Hardware Group, Inc. All rights reserved. Reproduction in whole or in part without the express written permission of ASSA ABLOY Access and Egress Hardware Group, Inc. is prohibited. Patent pending and/or patent www.assaabloydss.com/patents.



Institution or Utility

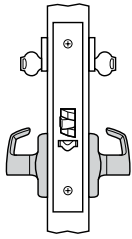

	For 1-3/4" Min. Doors			For 1-3/8" Doors
Type	Standard	Master Ring	Vandal Resistant	1" Front
Function	ML2032	MR Option	ML2032VR	D138 Option

Item	Part No.	Description
S/A		Lever Lock Body (No Cylinder or Trim) for
	700F29-8*	Standard
	700F39-8*	D138 Option
	710F29-8*	MR Option
	703F29-8*	Vandal Resistant
1		Case & Front Sub Assembly for
	687F53-8*	Standard
	687F54-8*	D138 Option
	687F58-8*	MR Option
2		Cap, Case for
	700F27-8*	Standard
	700F57-8*	MR Option
3	700F70-8*	Lever, Stop
5		Hub (Case Side)
	684F10-8**	Standard
	684F10-7	Vandal Resistant
6		Hub (Case Side)
	684F09-8**	Standard
	684F09-7	Vandal Resistant
7	684F05-5	Stop
8	684F55-9	Stop, Fixed
10	688F17-7	Latchbolt Sub Assembly
13	624F48-8*	Lever, Deadlocking
14	700F90-7	Spring, Deadlocking Lever
15	403F67-7	Latch, Auxiliary
16	678F54-8*	Lever, Auxiliary
17	678F67-7	Spring, Auxiliary Lever

Item	Part No.	Description
22	688F14-8*	Lever, Cylinder Latch
23	681F48-9	Stop, Cylinder Latch Lever
24	436F17-7	Ring, Retaining
31	402F73-8*	Bracket, Cylinder Set Screw
32	404F86-8*	Bracket, Align
35	684F18-8**	Screw, FHUM-PH-TITE #8-32 x 3/8"
36	684F11-9	Spacer, Hub
38	684F06-7	Screw, Stop
50	<i>Specify Finish</i>	Armored Front for
	624F49	Standard
	624F53	D138 Option
51	236L73 018	Std. Strike (See page 76 for options)
52	<i>Specify Finish</i>	Mortise Lock Mounting Packet
	429F41	Standard
	488F09	MR Option
	465F57	Vandal Resistant & M04
	616F12	MR x M04 (See page 109 for packet descriptions)
		Cylinder Set Screw for
	488F08-8	Standard & Vandal Resistant
	488F10-8	MR Option

*For M26 Option, replace suffix "-8" with "-2".

**For M26 Option, replace suffix "-8" with "-7".

The warranty on Corbin Russwin products becomes void if the product is modified in any way, regardless of whether the modifications causes or contributes to any alleged defect. If a Corbin Russwin product is modified it may no longer meet industry certification and quality control standards applicable to the original product and is no longer a genuine Corbin Russwin product.

Copyright © 2000-2020, ASSA ABLOY Access and Egress Hardware Group, Inc. All rights reserved. Reproduction in whole or in part without the express written permission of ASSA ABLOY Access and Egress Hardware Group, Inc. is prohibited. Patent pending and/or patent www.assaabloydss.com/patents.



Institution or Utility

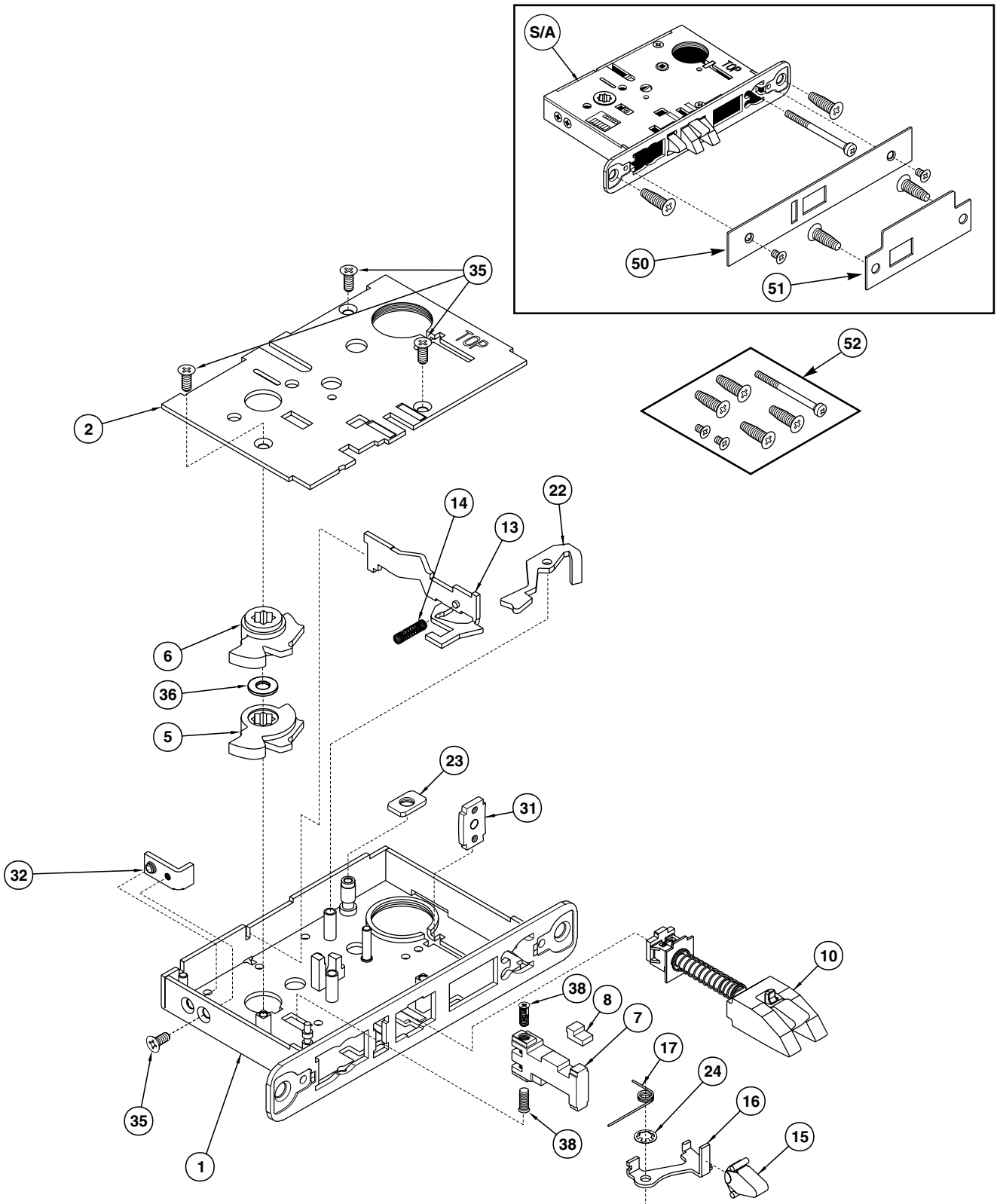

The warranty on Corbin Russwin products becomes void if the product is modified in any way, regardless of whether the modifications causes or contributes to any alleged defect. If a Corbin Russwin product is modified it may no longer meet industry certification and quality control standards applicable to the original product and is no longer a genuine Corbin Russwin product.

Copyright © 2000-2020, ASSA ABLOY Access and Egress Hardware Group, Inc. All rights reserved. Reproduction in whole or in part without the express written permission of ASSA ABLOY Access and Egress Hardware Group, Inc. is prohibited. Patent pending and/or patent www.assaabloydss.com/patents.



Entrance or Public Restroom, Classroom

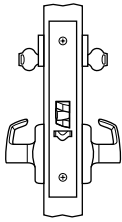

	For 1-3/4" Min. Doors			For 1-3/8" Doors
Type	Standard	Master Ring	Vandal Resistant	1" Front
Function	ML2042	MR Option	ML2042VR	D138 Option

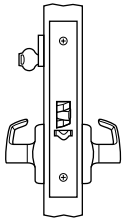

	For 1-3/4" Min. Doors			For 1-3/8" Doors
Type	Standard	Master Ring	Vandal Resistant	1" Front
Function	ML2055	MR Option	ML2055VR	D138 Option

Item	Part No.	Description
S/A		Lever Lock Body (No Cylinder or Trim) for
	700F08-8*	Standard
	700F18-8*	D138 Option
	710F08-8*	MR Option
	778F08-8*	Latch Hold Back Option
	778F18-8*	LHB x D138
	703F08-8*	Vandal Resistant
1		Case & Front Sub Assembly for
	687F53-8*	Standard
	687F54-8*	D138 Option
	687F58-8*	MR Option
2		Cap, Case for
	700F27-8*	Standard
	700F57-8*	MR Option
3	681F44-8	Lever, Stop
5		Hub (Case Side)
	684F10-8**	Standard
	684F10-7	Vandal Resistant
6		Hub (Case Side)
	684F09-8**	Standard
	684F09-7	Vandal Resistant
7	684F05-5	Stop
10	688F17-7	Latchbolt Sub Assembly
13	624F48-8*	Lever, Deadlocking
14	700F90-7	Spring, Deadlocking Lever

Item	Part No.	Description
15	403F67-7	Latch, Auxiliary
16	678F54-8*	Lever, Auxiliary
17	678F67-7	Spring, Auxiliary Lever
18	681F37-8*	Lever, Hub
19	688F03-8**	Retractor
20	690F82-7	Spring, Retractor
21	565F04-8**	Spring, Hub Lever
22	688F14-8*	Lever, Cylinder Latch
23	681F48-9	Stop, Cylinder Latch Lever
24	436F17-7	Ring, Retaining
25	685F38-7	Spring, Stop
29	466F22-9	Spacer
30	404F85-8**	Spring, Lever Return
31	402F73-8*	Bracket, Cylinder Set Screw
32	404F86-8*	Bracket, Align
33	701F70-5***	Lever, Stop Cylinder
35	684F18-8**	Screw, FHUM-PH-TITE #8-32 x 3/8"
36	684F11-9	Spacer, Hub
37	684F12-9	Spacer, Spring
38	684F06-7	Screw, Stop
43	701F54-5***	Lever, Hold Back
50	<i>Specify Finish</i>	Armored Front for
	624F49	Standard
	624F53	D138 Option
	681F34	LHB - Standard
	681F35	LHB x D138

*For M26 Option, replace suffix "-8" with "-2".
 **For M26 Option, replace suffix "-8" with "-7".
 ***For LHB Option.

The warranty on Corbin Russwin products becomes void if the product is modified in any way, regardless of whether the modifications causes or contributes to any alleged defect. If a Corbin Russwin product is modified it may no longer meet industry certification and quality control standards applicable to the original product and is no longer a genuine Corbin Russwin product.

Copyright © 2000-2020, ASSA ABLOY Access and Egress Hardware Group, Inc. All rights reserved. Reproduction in whole or in part without the express written permission of ASSA ABLOY Access and Egress Hardware Group, Inc. is prohibited. Patent pending and/or patent www.assaabloy.com/patents.





Entrance or Public Restroom, Classroom

Item	Part No.	Description
51	236L73 018	Std. Strike (See page 76 for options)
52	<i>Specify Finish</i>	Mortise Lock Mounting Packet For
	429F41	Standard
	488F09	MR Option
	465F57	Vandal Resistant & M04
	616F12	MR x M04 (See page 109 for packet descriptions)
		NOTE: For double cylinder functions an additional cylinder set screw is required.
	488F08-8	Standard
	488F10-8	MR Option

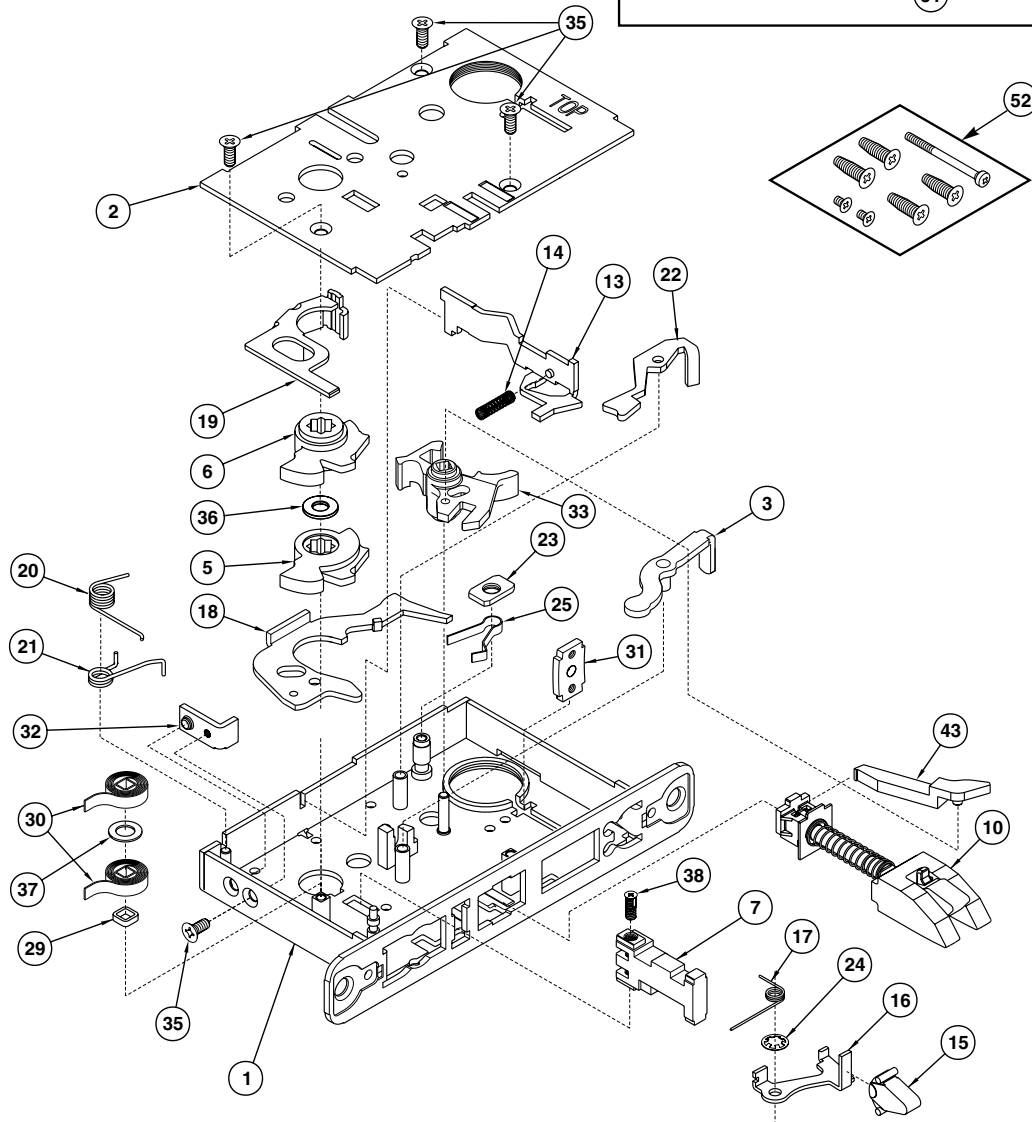
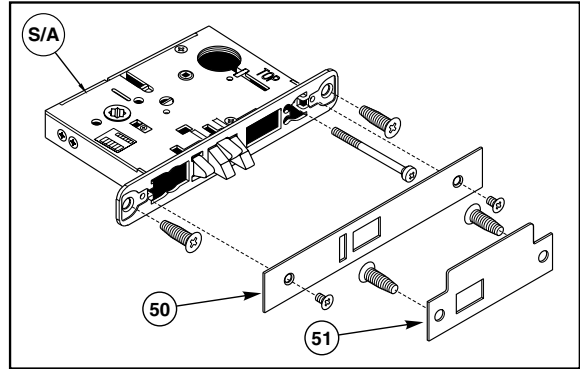

The warranty on Corbin Russwin products becomes void if the product is modified in any way, regardless of whether the modifications causes or contributes to any alleged defect. If a Corbin Russwin product is modified it may no longer meet industry certification and quality control standards applicable to the original product and is no longer a genuine Corbin Russwin product.

Copyright © 2000-2020, ASSA ABLOY Access and Egress Hardware Group, Inc. All rights reserved. Reproduction in whole or in part without the express written permission of ASSA ABLOY Access and Egress Hardware Group, Inc. is prohibited. Patent pending and/or patent www.assaabloydss.com/patents.



Entrance or Apartment

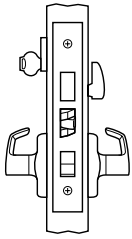

	For 1-3/4" Min. Doors			For 1-3/8" Doors
Type	Standard	Master Ring	Vandal Resistant	1" Front
Function	ML2048	MR Option	ML2048VR	D138 Option

Item	Part No.	Description
S/A		Lever Lock Body (No Cylinder or Trim) for
	700F04-8*	Standard
	700F14-8	D138 Option
	710F04-8	MR Option
	703F04-8*	Vandal Resistant
1		Case & Front Sub Assembly for
	687F53-8*	Standard
	687F54-8*	D138 Option
	687F58-8*	MR Option
2		Cap, Case for
	700F27-8*	Standard
	700F57-8*	MR Option
5		Hub (Case Side)
	684F10-8**	Standard
	684F10-7	Vandal Resistant
6		Hub (Case Side)
	684F09-8**	Standard
	684F09-7	Vandal Resistant
7	684F05-5	Stop
9		Hub, Turnpiece for
	700F23-5	Standard
	700F31-5	MR Option
10	688F17-7	Latchbolt Sub Assembly
11	702F98-7	Deadbolt
12	701F22-8**	Spring, Deadbolt
18	681F37-8*	Lever, Hub
19	688F03-8**	Retractor
20	690F82-7	Spring, Retractor
21	565F04-8**	Spring, Hub Lever
22	688F14-8*	Lever, Cylinder Latch

Item	Part No.	Description
26	461F01-2	Toggle Sub Assembly
27	402F63-7	Spring, Toggle
28	402F61-7	Spring, Seat
29	466F22-9	Spacer
30	404F85-8**	Spring, Lever Return
31	402F73-8*	Bracket, Cylinder Set Screw
32	404F86-8*	Bracket, Align
35	684F18-8**	Screw, FHUM-PH-TITE #8-32 x 3/8"
36	684F11-9	Spacer, Hub
37	684F12-9	Spacer, Spring
38	684F06-7	Screw, Stop
50	<i>Specify Finish</i>	Armored Front for
	402F31	Standard
	402F35	D138 Option
51	236L72 018	Std. Strike (See page 76 for options)
52	<i>Specify Finish</i>	Mortise Lock Mounting Packet for
	429F41	Standard
	488F09	MR Option
	465F57	Vandal Resistant & M04
	616F12	MR x M04 (See page 109 for packet descriptions)
53	700F95-7	Spring, Latch Lever

*For M26 Option, replace suffix "-8" with "-2".

**For M26 Option, replace suffix "-8" with "-7".

The warranty on Corbin Russwin products becomes void if the product is modified in any way, regardless of whether the modifications causes or contributes to any alleged defect. If a Corbin Russwin product is modified it may no longer meet industry certification and quality control standards applicable to the original product and is no longer a genuine Corbin Russwin product.

Copyright © 2000-2020, ASSA ABLOY Access and Egress Hardware Group, Inc. All rights reserved. Reproduction in whole or in part without the express written permission of ASSA ABLOY Access and Egress Hardware Group, Inc. is prohibited. Patent pending and/or patent www.assaabloydss.com/patents.



Entrance or Apartment

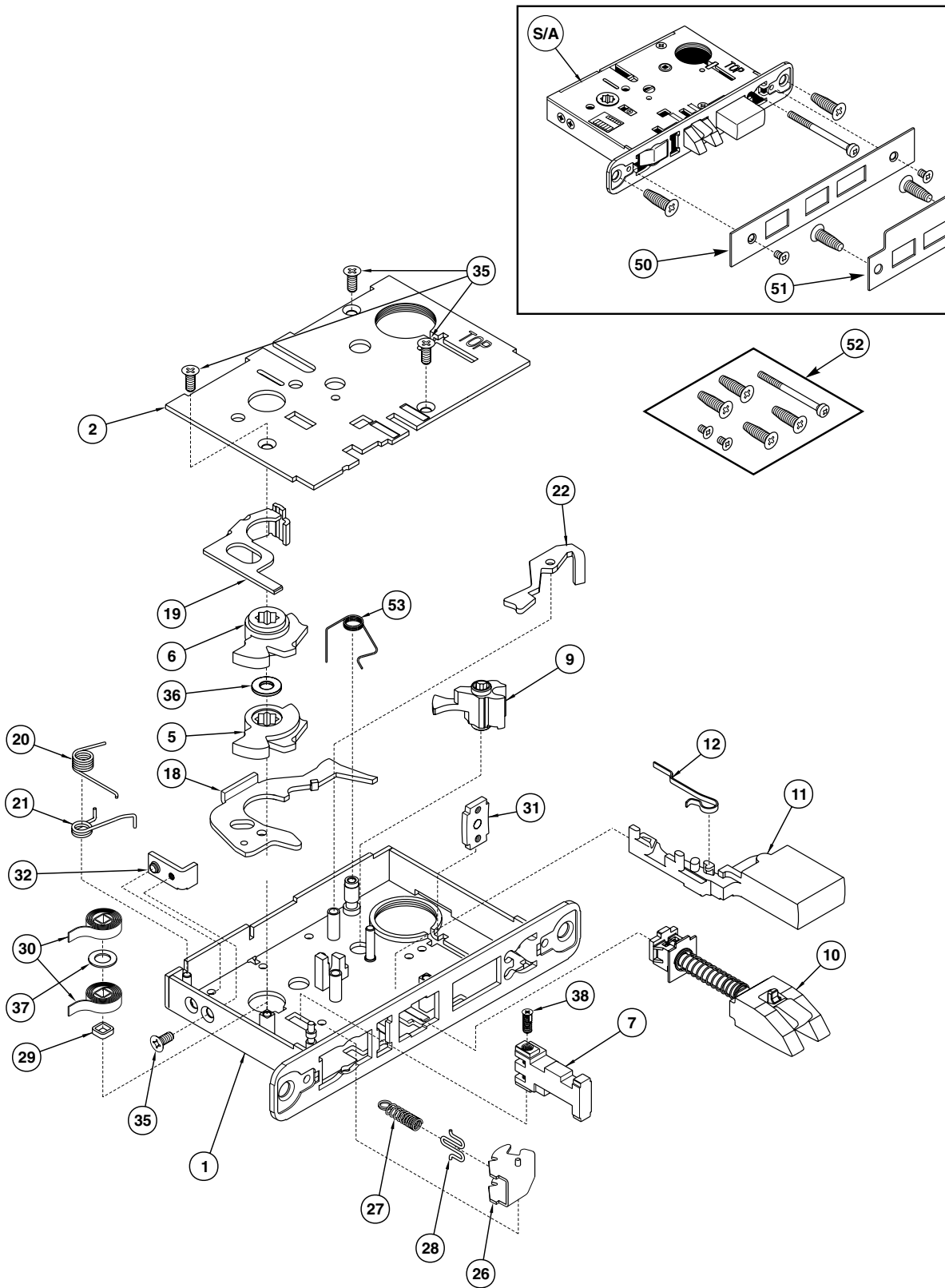

The warranty on Corbin Russwin products becomes void if the product is modified in any way, regardless of whether the modifications causes or contributes to any alleged defect. If a Corbin Russwin product is modified it may no longer meet industry certification and quality control standards applicable to the original product and is no longer a genuine Corbin Russwin product.

Copyright © 2000-2020, ASSA ABLOY Access and Egress Hardware Group, Inc. All rights reserved. Reproduction in whole or in part without the express written permission of ASSA ABLOY Access and Egress Hardware Group, Inc. is prohibited. Patent pending and/or patent www.assaabloydss.com/patents.



Entrance or Office

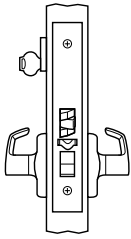

	For 1-3/4" Min. Doors			For 1-3/8" Doors
Type	Standard	Master Ring	Vandal Resistant	1" Front
Function	ML2051	MR Option	ML2051VR	D138 Option

Item	Part No.	Description
22	701F748	Lever, Cylinder Latch
23	705F949	Stop, Cylinder Latch Lever
24	436F17-7	Ring, Retaining
25	685F38-7***	Spring, Stop
26	461F01-2	Toggle Sub Assembly
27	402F63-7	Spring, Toggle
28	402F61-7	Spring, Seat
29	466F22-9	Spacer
30	404F85-8**	Spring, Lever Return
31	402F73-8*	Bracket, Cylinder Set Screw
32	404F86-8*	Bracket, Align
33	701F70-5***	Lever, Stop Cylinder
35	684F18-8**	Screw, FHUM-PH-TITE #8-32 x 3/8"
36	684F11-9	Spacer, Hub
37	684F12-9	Spacer, Spring
38	684F06-7	Screw, Stop
43	701F56-5***	Lever, Hold Back
50	<i>Specify Finish</i>	Armored Front for
	681F31	Standard
	681F30	D138 Option
	681F41	LHB Standard
	681F40	LHB x D138
51	236L72 018	Std. Strike (See page 76 for options)
52	<i>Specify Finish</i>	Mortise Lock Mounting Packet for
	429F41	Standard
	488F09	MR Option
	465F57	Vandal Resistant & M04
	616F12	MR x M04 (See page 109 for packet descriptions)

*For M26 Option, replace suffix "-8" with "-2".
 **For M26 Option, replace suffix "-8" with "-7".

The warranty on Corbin Russwin products becomes void if the product is modified in any way, regardless of whether the modifications causes or contributes to any alleged defect. If a Corbin Russwin product is modified it may no longer meet industry certification and quality control standards applicable to the original product and is no longer a genuine Corbin Russwin product.

Copyright © 2000-2020, ASSA ABLOY Access and Egress Hardware Group, Inc. All rights reserved. Reproduction in whole or in part without the express written permission of ASSA ABLOY Access and Egress Hardware Group, Inc. is prohibited. Patent pending and/or patent www.assaabloydss.com/patents.



Entrance or Office

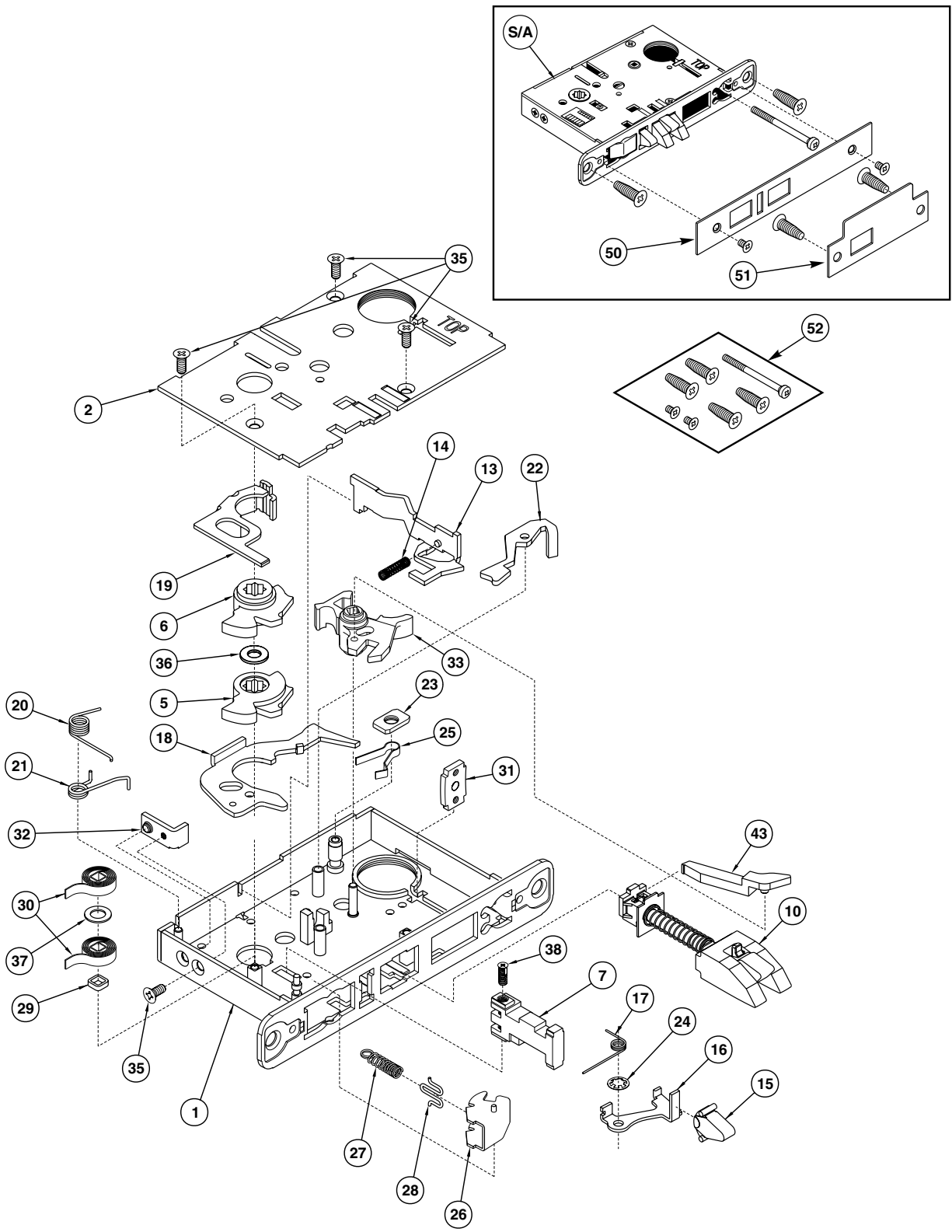

The warranty on Corbin Russwin products becomes void if the product is modified in any way, regardless of whether the modifications causes or contributes to any alleged defect. If a Corbin Russwin product is modified it may no longer meet industry certification and quality control standards applicable to the original product and is no longer a genuine Corbin Russwin product.

Copyright © 2000-2020, ASSA ABLOY Access and Egress Hardware Group, Inc. All rights reserved. Reproduction in whole or in part without the express written permission of ASSA ABLOY Access and Egress Hardware Group, Inc. is prohibited. Patent pending and/or patent www.assaabloydss.com/patents.





Storeroom or Closet

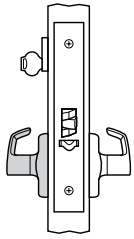

	For 1-3/4" Min. Doors			For 1-3/8" Doors
Type	Standard	Master Ring	Vandal Resistant	1" Front
Function	ML2057	MR Option	ML2057VR	D138 Option

Item	Part No.	Description
S/A		Lever Lock Body (No Cylinder or Trim) for
	700F09-8*	Standard
	700F19-8*	D138 Option
	710F09-8*	MR Option
	778F09-8*	Latch Hold Back Option
	778F19-8	LHB x D138
	703F09-8*	Vandal Resistant
1		Case & Front Sub Assembly for
	687F53-8*	Standard
	687F54-8*	D138 Option
	687F58-8*	MR Option
2		Cap, Case for
	700F27-8*	Standard
	700F57-8*	MR Option
5		Hub (Case Side)
	684F10-8**	Standard
	684F10-7	Vandal Resistant
6		Hub (Case Side)
	684F09-8**	Standard
	684F09-7	Vandal Resistant
7	684F05-5	Stop
8	684F55-9	Stop, Fixed
10	688F17-7	Latchbolt Sub Assembly
13	602F19-8*	Lever, Deadlocking
14	700F90-7	Spring, Deadlocking Lever
15	403F67-7	Latch, Auxiliary
16	678F54-8*	Lever, Auxiliary
17	678F67-7	Spring, Auxiliary Lever
18	681F37-8*	Lever, Hub
19	688F03-8**	Retractor
20	690F82-7	Spring, Retractor

Item	Part No.	Description
21	565F04-8**	Spring, Hub Lever
22	701F748	Lever, Cylinder Latch
23	705F949	Stop, Cylinder Latch Lever
24	436F17-7	Ring, Retaining
25	685F38-7***	Spring, Stop
29	466F22-9	Spacer
30	404F85-8**	Spring, Lever Return
31	402F73-8*	Bracket, Cylinder Set Screw
32	404F86-8*	Bracket, Align
33	701F70-5***	Lever, Stop Cylinder
35	684F18-8**	Screw, FHUM-PH-TITE #8-32 x 3/8"
36	684F11-9	Spacer, Hub
37	684F12-9	Spacer, Spring
38	684F06-7	Screw, Stop
43	701F56-5***	Lever, Hold Back
50	<i>Specify Finish</i>	Armored Front for
	624F49	Standard
	624F53	D138 Option
	681F34	LHB Standard
	681F35	LHB x D138
51	236L73 018	Std. Strike (See page 76 for options)
52	<i>Specify Finish</i>	Mortise Lock Mounting Packet for
	429F41	Standard
	488F09	MR Option
	465F57	Vandal Resistant & M04
	616F12	MR x M04 (See page 109 for packet descriptions)

*For M26 Option, replace suffix "-8" with "-2".

**For M26 Option, replace suffix "-8" with "-7".

***For LHB Option.

The warranty on Corbin Russwin products becomes void if the product is modified in any way, regardless of whether the modifications causes or contributes to any alleged defect. If a Corbin Russwin product is modified it may no longer meet industry certification and quality control standards applicable to the original product and is no longer a genuine Corbin Russwin product.

Copyright © 2000-2020, ASSA ABLOY Access and Egress Hardware Group, Inc. All rights reserved. Reproduction in whole or in part without the express written permission of ASSA ABLOY Access and Egress Hardware Group, Inc. is prohibited. Patent pending and/or patent www.assaabloydss.com/patents.



Storeroom or Closet

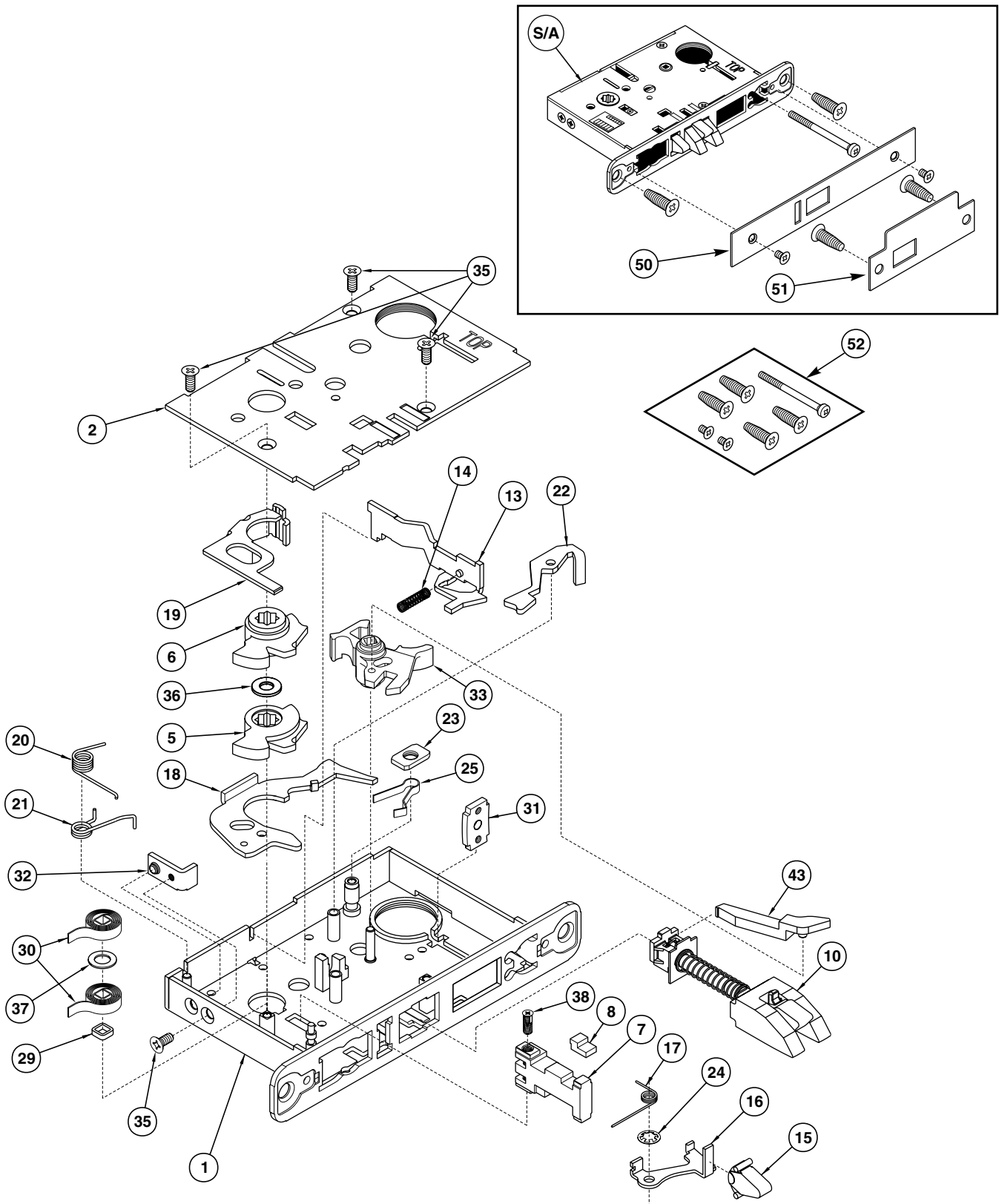

The warranty on Corbin Russwin products becomes void if the product is modified in any way, regardless of whether the modifications causes or contributes to any alleged defect. If a Corbin Russwin product is modified it may no longer meet industry certification and quality control standards applicable to the original product and is no longer a genuine Corbin Russwin product.

Copyright © 2000-2020, ASSA ABLOY Access and Egress Hardware Group, Inc. All rights reserved. Reproduction in whole or in part without the express written permission of ASSA ABLOY Access and Egress Hardware Group, Inc. is prohibited. Patent pending and/or patent www.assaabloydss.com/patents.





Privacy

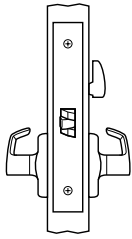

	For 1-3/4" Min. Doors			For 1-3/8" Doors
Type	Standard	Master Ring	Vandal Resistant	1" Front
Function	ML2060	-----	ML2060VR	D138 Option

Item	Part No.	Description
S/A	700F76-8*	Lever Lock Body (No Cylinder or Trim) for Standard
	700F77-8*	D138 Option
	703F76-8*	Vandal Resistant
1	687F55-8*	Case & Front Sub Assembly for Standard
	687F56-8*	D138 Option
2	700F27-8*	Cap, Case for
3	682F01-8	Lever Sub Assembly, Stop
5	684F10-8**	Hub (Case Side) Standard
	684F10-7	Vandal Resistant
6	684F09-8**	Hub (Case Side) Standard
	684F09-7	Vandal Resistant
7	684F05-5	Stop
9	624F44-5	Hub, Turnpiece
10	688F17-7	Latchbolt Sub Assembly
18	681F37-8*	Lever, Hub
19	688F03-8**	Retractor
20	690F82-7	Spring, Retractor
21	565F04-8**	Spring, Hub Lever
29	466F22-9	Spacer
30	404F85-8**	Spring, Lever Return
31	402F73-8*	Bracket, Cylinder Set Screw
32	404F86-8*	Bracket, Align

Item	Part No.	Description
35	684F18-8**	Screw, FHUM-PH-TITE #8-32 x 3/8"
36	684F11-9	Spacer, Hub
37	684F12-9	Spacer, Spring
38	684F06-7	Screw, Stop
39	468F32-9	Label, Operator/Date
40	388F01-9	Label, UL
41	685F17-9	Label, Identification
44	624F42-7	Spring
45	624F43-9	Spacer
46	624F44-9	Spacer
47	688F01-7	Spring, Kickoff
50	<i>Specify Finish</i>	Armored Front for
	423F55	Standard
	423F58	D138 Option
51	236L73 018	Std. Strike (See page 76 for options)
52	<i>Specify Finish</i>	Mortise Lock Mounting Packet for
	429F41	Standard
	465F57	Vandal Resistant & M04 (See page 109 for packet descriptions)

*For M26 Option, replace suffix "-8" with "-2".
 **For M26 Option, replace suffix "-8" with "-7".

The warranty on Corbin Russwin products becomes void if the product is modified in any way, regardless of whether the modifications causes or contributes to any alleged defect. If a Corbin Russwin product is modified it may no longer meet industry certification and quality control standards applicable to the original product and is no longer a genuine Corbin Russwin product.

Copyright © 2000-2020, ASSA ABLOY Access and Egress Hardware Group, Inc. All rights reserved. Reproduction in whole or in part without the express written permission of ASSA ABLOY Access and Egress Hardware Group, Inc. is prohibited. Patent pending and/or patent www.assaabloydss.com/patents.



Privacy

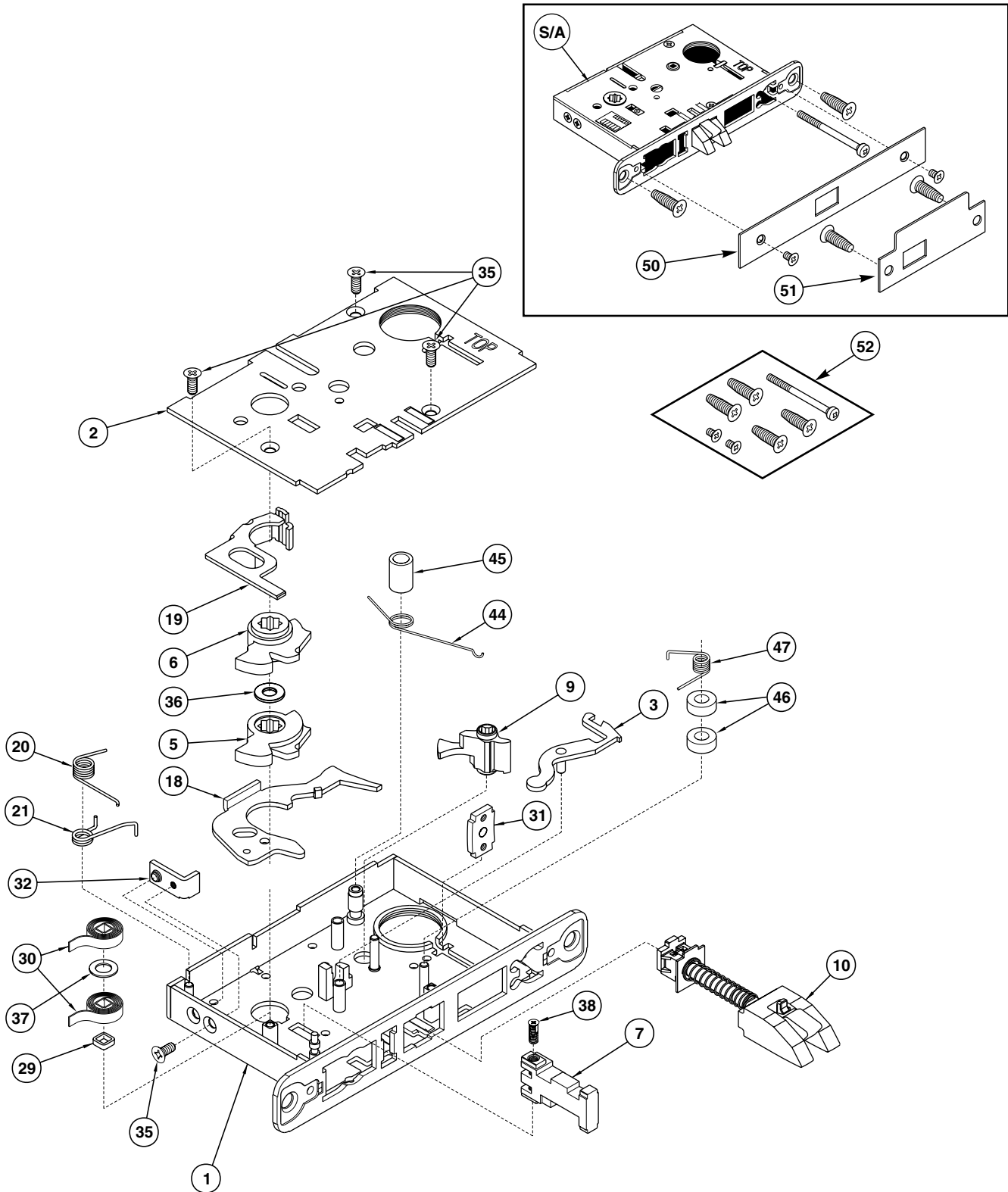

The warranty on Corbin Russwin products becomes void if the product is modified in any way, regardless of whether the modifications causes or contributes to any alleged defect. If a Corbin Russwin product is modified it may no longer meet industry certification and quality control standards applicable to the original product and is no longer a genuine Corbin Russwin product.

Copyright © 2000-2020, ASSA ABLOY Access and Egress Hardware Group, Inc. All rights reserved. Reproduction in whole or in part without the express written permission of ASSA ABLOY Access and Egress Hardware Group, Inc. is prohibited. Patent pending and/or patent www.assaabloydss.com/patents.





Apartment or Dormitory

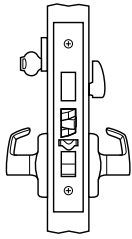

	For 1-3/4" Min. Doors			For 1-3/8" Doors
Type	Standard	Master Ring	Vandal Resistant	1" Front
Function	ML2067	MR Option	ML2067VR	D138 Option

Item	Part No.	Description
S/A		Lever Lock Body (No Cylinder or Trim) for
	700F01-8*	Standard
	700F11-8*	D138 Option
	710F01-8*	MR Option
	703F01-8*	Vandal Resistant
1		Case & Front Sub Assembly for
	687F53-8*	Standard
	687F54-8	D138 Option
	687F58-8*	MR Option
2	700F27-8*	Cap, Case for
	701F57-8	MR Option
3	700F74-8	Lever, Stop
5		Hub (Case Side)
	684F10-8**	Standard
	684F10-7	Vandal Resistant
6		Hub (Case Side)
	684F09-8**	Standard
	684F09-7	Vandal Resistant
7	684F05-5	Stop
9		Hub, Turnpiece for
	813F505	Standard
10	688F17-7	Latchbolt Sub Assembly
11	702F98-7	Deadbolt
12	701F22-8	Spring, Deadbolt
13	602F19-8*	Lever, Deadlocking
14	700F90-7	Spring, Deadlocking Lever
15	403F67-7	Latch, Auxiliary
16	678F54-8*	Lever, Auxiliary
17	678F67-7	Spring, Auxiliary Lever
18	681F37-8*	Lever, Hub

Item	Part No.	Description
19	688F03-8**	Retractor
20	690F82-7	Spring, Retractor
21	565F04-8**	Spring, Hub Lever
22	701F748	Lever, Cylinder Latch
24	436F17-7	Ring, Retaining
26	461F01-2	Toggle Sub Assembly
27	402F63-7	Spring, Toggle
28	402F61-7	Spring, Seat
29	466F22-9	Spacer
30	404F85-8**	Spring, Lever Return
31	402F73-8*	Bracket, Cylinder Set Screw
32	404F86-8*	Bracket, Align
35	684F18-8**	Screw, FHUM-PH-TITE #8-32 x 3/8"
36	684F11-9	Spacer, Hub
37	684F12-9	Spacer, Spring
38	684F06-7	Screw, Stop
50	<i>Specify Finish</i>	Armored Front for
	402F29	Standard
	402F33	D138 Option
51	236L72 018	Std. Strike (See page 76 for options)
52	<i>Specify Finish</i>	Mortise Lock Mounting Packet for
	429F41	Standard
	488F09	MR Option
	465F57	Vandal Resistant & M04
	616F12	MR x M04 (See page 109 for packet descriptions)
53	700F95-7	Spring, Latch Lever

*For M26 Option, replace suffix "-8" with "-2".
 **For M26 Option, replace suffix "-8" with "-7".

The warranty on Corbin Russwin products becomes void if the product is modified in any way, regardless of whether the modifications causes or contributes to any alleged defect. If a Corbin Russwin product is modified it may no longer meet industry certification and quality control standards applicable to the original product and is no longer a genuine Corbin Russwin product.

Copyright © 2000-2020, ASSA ABLOY Access and Egress Hardware Group, Inc. All rights reserved. Reproduction in whole or in part without the express written permission of ASSA ABLOY Access and Egress Hardware Group, Inc. is prohibited. Patent pending and/or patent www.assaabloydss.com/patents.





Apartment or Dormitory

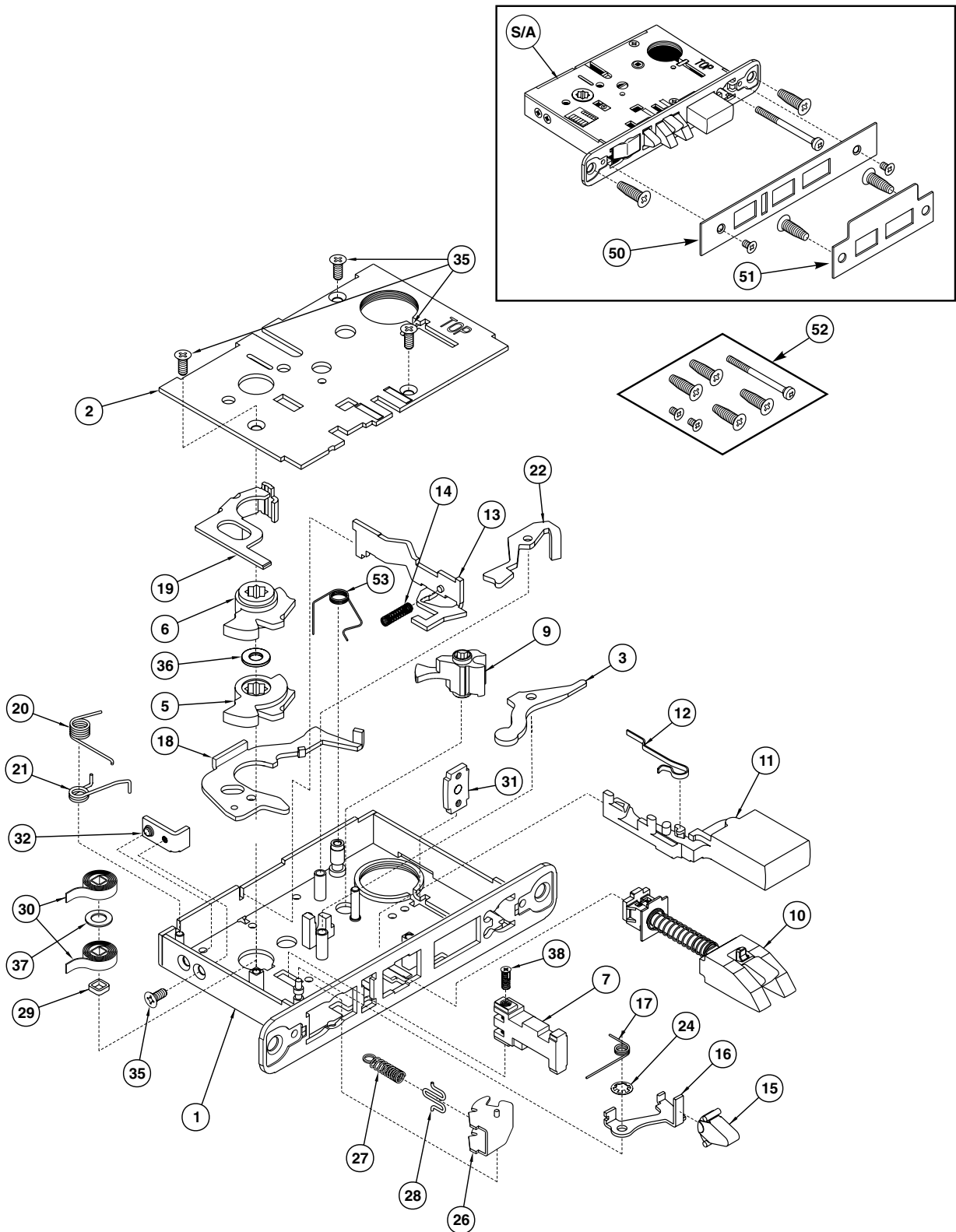

The warranty on Corbin Russwin products becomes void if the product is modified in any way, regardless of whether the modifications causes or contributes to any alleged defect. If a Corbin Russwin product is modified it may no longer meet industry certification and quality control standards applicable to the original product and is no longer a genuine Corbin Russwin product.

Copyright © 2000-2020, ASSA ABLOY Access and Egress Hardware Group, Inc. All rights reserved. Reproduction in whole or in part without the express written permission of ASSA ABLOY Access and Egress Hardware Group, Inc. is prohibited. Patent pending and/or patent www.assaabloydss.com/patents.



Institutional Privacy

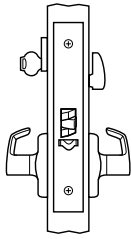

	For 1-3/4" Min. Doors			For 1-3/8" Doors
Type	Standard	Master Ring	Vandal Resistant	1" Front
Function	ML2069	-----	ML2069VR	D138 Option

Item	Part No.	Description
S/A		Lever Lock Body (No Cylinder or Trim) for
	700F51-8*	Standard
	700F58-8*	D138 Option
	703F51-8*	Vandal Resistant
1		Case & Front Sub Assembly for
	687F55-8*	Standard
	687F56-8*	D138 Option
2	700F27-8*	Cap, Case
3	700F74-8	Lever, Stop
5		Hub (Case Side)
	684F10-8**	Standard
	684F10-7	Vandal Resistant
6		Hub (Case Side)
	684F09-8**	Standard
	684F09-7	Vandal Resistant
7	684F05-5	Stop
9	624F44-5	Hub, Turnpiece
10	688F17-7	Latchbolt Sub Assembly
13	624F48-8*	Lever, Deadlocking
14	700F90-7	Spring, Deadlocking Lever
15	403F67-7	Latch, Auxiliary
16	678F54-8*	Lever, Auxiliary
17	678F67-7	Spring, Auxiliary Lever
18	681F37-8*	Lever, Hub
19	688F03-8**	Retractor
20	690F82-7	Spring, Retractor
21	565F04-8**	Spring, Hub Lever
22	688F14-8*	Lever, Cylinder Latch
23	681F48-9	Stop, Cylinder Latch Lever
24	436F17-7	Ring, Retaining

Item	Part No.	Description
29	466F22-9	Spacer
30	404F85-8**	Spring, Lever Return
31	402F73-8*	Bracket, Cylinder Set Screw
32	404F86-8*	Bracket, Align
35	684F18-8**	Screw, FHUM-PH-TITE #8-32 x 3/8"
36	684F11-9	Spacer, Hub
37	684F12-9	Spacer, Spring
38	684F06-7	Screw, Stop
44	624F42-7	Spring
45	624F43-9	Spacer
46	624F44-9	Spacer
47	688F01-7	Spring, Kickoff
50	<i>Specify Finish</i>	Armored Front for
	624F49	Standard
	624F53	D138
	465F57	Vandal Resistant
51	236L73 018	Std. Strike (See page 76 for options)
52	<i>Specify Finish</i>	Mortise Lock Mounting Packet for
	429F41	Vandal Resistant & M04
	465F57	(See page 109 for packet descriptions)

*For M26 Option, replace suffix "-8" with "-2".
 **For M26 Option, replace suffix "-8" with "-7".

The warranty on Corbin Russwin products becomes void if the product is modified in any way, regardless of whether the modifications causes or contributes to any alleged defect. If a Corbin Russwin product is modified it may no longer meet industry certification and quality control standards applicable to the original product and is no longer a genuine Corbin Russwin product.

Copyright © 2000-2020, ASSA ABLOY Access and Egress Hardware Group, Inc. All rights reserved. Reproduction in whole or in part without the express written permission of ASSA ABLOY Access and Egress Hardware Group, Inc. is prohibited. Patent pending and/or patent www.assaabloydss.com/patents.



Institutional Privacy

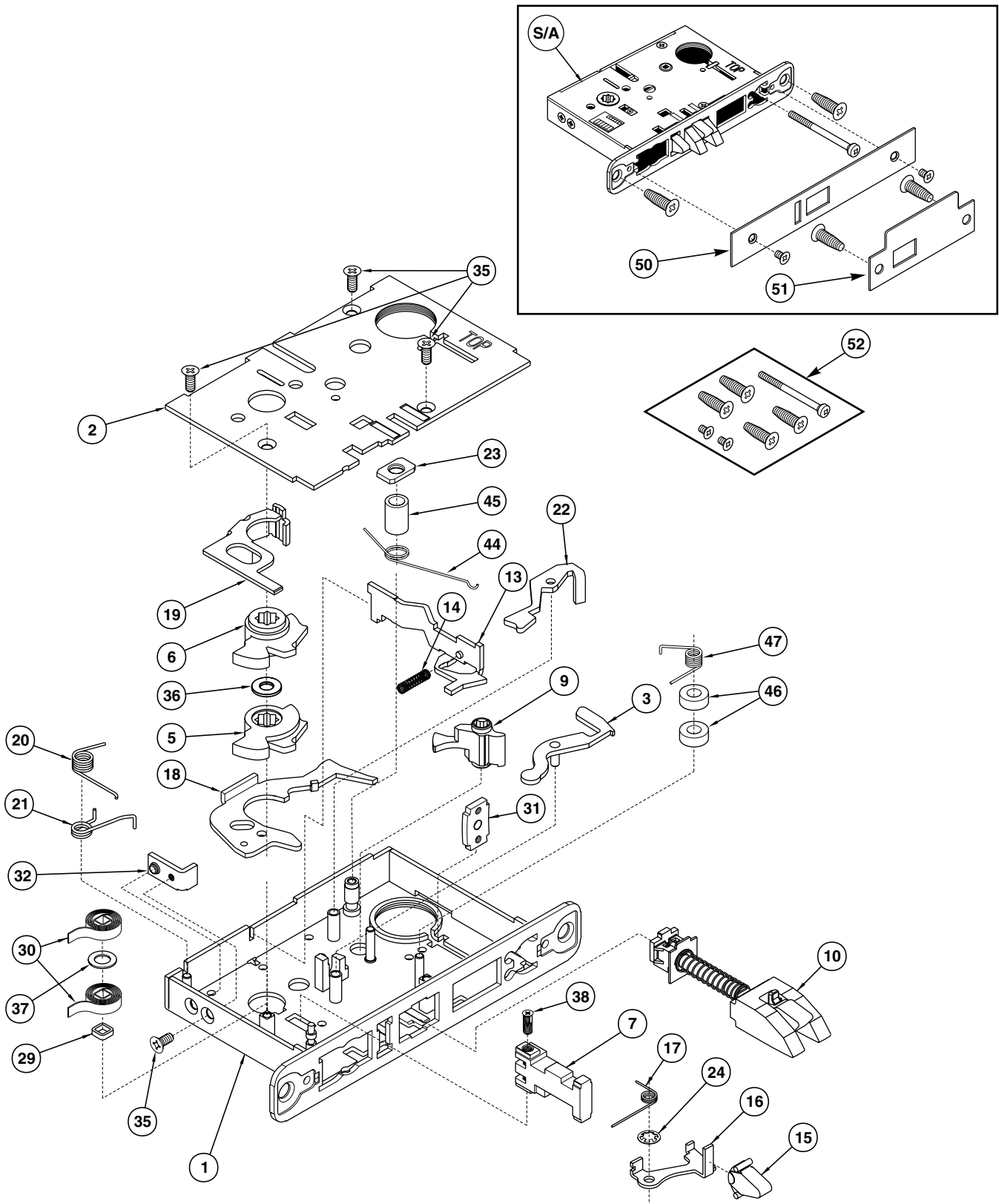

The warranty on Corbin Russwin products becomes void if the product is modified in any way, regardless of whether the modifications causes or contributes to any alleged defect. If a Corbin Russwin product is modified it may no longer meet industry certification and quality control standards applicable to the original product and is no longer a genuine Corbin Russwin product.

Copyright © 2000-2020, ASSA ABLOY Access and Egress Hardware Group, Inc. All rights reserved. Reproduction in whole or in part without the express written permission of ASSA ABLOY Access and Egress Hardware Group, Inc. is prohibited. Patent pending and/or patent www.assaabloydss.com/patents.





Classroom Security

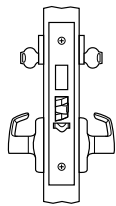

	For 1-3/4" Min. Doors			For 1-3/8" Doors
Type	Standard	Master Ring	Vandal Resistant	1" Front
Function	ML2072	MR Option	ML2072VR	D138 Option

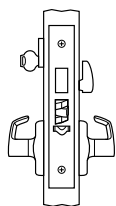

	For 1-3/4" Min. Doors			For 1-3/8" Doors
Type	Standard	Master Ring	Vandal Resistant	1" Front
Function	ML2075	MR Option	ML2075VR	D138 Option

Item	Part No.	Description	Item	Part No.	Description
S/A	700F75-8*	Lever Lock Body (No Cylinder or Trim) for Standard & Vandal Resistant	19	688F03-8**	Retractor
	700F85-8*	D138 Option	20	690F82-7	Spring, Retractor
	710F75-8	MR Option	21	565F04-8**	Spring, Hub Lever
1	687F53-8*	Case & Front Sub Assembly for Standard	22	753F098	Lever, Cylinder Latch
	687F54-8*	D138 Option	24	436F17-7	Ring, Retaining
	687F58-8*	MR Option	29	466F22-9	Spacer
2	700F27-8*	Cap, Case Standard	30	404F85-8**	Spring, Lever Return
	701F57-8*	MR Option	31	402F73-8*	Bracket, Cylinder Set Screw
3	753F078	Lever, Stop	32	404F86-8*	Bracket, Align
5	684F10-8**	Hub (Case Side) Standard	35	684F18-8**	Screw, FHUM-PH-TITE #8-32 x 3/8"
	684F10-7	Vandal Resistant	36	684F11-9	Spacer, Hub
6	684F09-8**	Hub (Case Side) Standard	37	684F12-9	Spacer, Spring
	684F09-7	Vandal Resistant	38	684F06-7	Screw, Stop
7	684F05-5	Stop	50	<i>Specify Finish</i>	Armored Front for
9	813F505	Hub, Turnpiece (standard)		402F30	Standard
	700F315	MR Option		402F34	D138
10	688F17-7	Latchbolt Sub Assembly	51	<i>Specify Finish</i>	Std. Strike (See page 76 for options)
11	702F98-7	Deadbolt	52	<i>Specify Finish</i>	Mortise Lock Mounting Packet for
12	701F22-8	Spring, Deadbolt		429F41	Standard
13	624F48-8*	Lever, Deadlocking		488F09	MR Option
14	700F90-7	Spring, Deadlocking Lever		465F57	Vandal Resistant & M04
15	403F67-7	Latch, Auxiliary		616F12	MR x M04 (See page 109 for packet descriptions)
16	678F54-8*	Lever, Auxiliary			(NOTE: For double cylinder functions an additional cylinder set screw is required.)
17	678F67-7	Spring, Auxiliary Lever			Cylinder Set Screw For
18	681F368	Lever, Hub		488F08-8	Standard & Vandal Resistant
				488F10-8	MR Option
			53	700F95-7	Spring, Latch Lever
			54	703F99-7	Spring, Stop

*For M26 Option, replace suffix "-8" with "-2".
 **For M26 Option, replace suffix "-8" with "-7".

The warranty on Corbin Russwin products becomes void if the product is modified in any way, regardless of whether the modifications causes or contributes to any alleged defect. If a Corbin Russwin product is modified it may no longer meet industry certification and quality control standards applicable to the original product and is no longer a genuine Corbin Russwin product.

Copyright © 2000-2020, ASSA ABLOY Access and Egress Hardware Group, Inc. All rights reserved. Reproduction in whole or in part without the express written permission of ASSA ABLOY Access and Egress Hardware Group, Inc. is prohibited. Patent pending and/or patent www.assaabloydss.com/patents.





Classroom Security

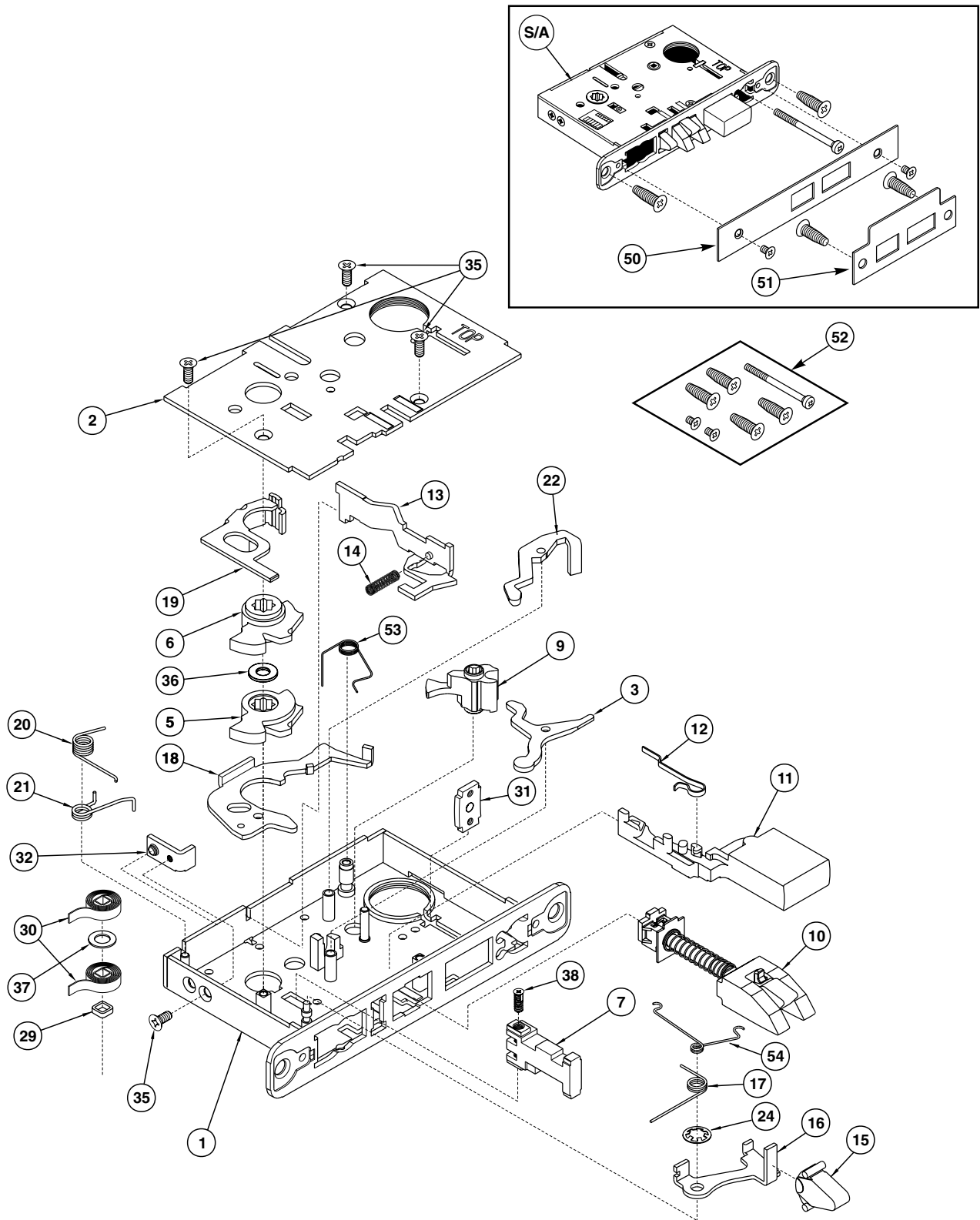

The warranty on Corbin Russwin products becomes void if the product is modified in any way, regardless of whether the modifications causes or contributes to any alleged defect. If a Corbin Russwin product is modified it may no longer meet industry certification and quality control standards applicable to the original product and is no longer a genuine Corbin Russwin product.

Copyright © 2000-2020, ASSA ABLOY Access and Egress Hardware Group, Inc. All rights reserved. Reproduction in whole or in part without the express written permission of ASSA ABLOY Access and Egress Hardware Group, Inc. is prohibited. Patent pending and/or patent www.assaabloydss.com/patents.

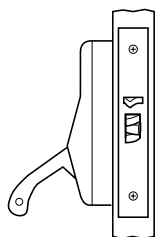

NOTE:
MLE03 (no trim)
function side view
shown as example.

		To Support Discontinued Double Cyl. Devices		
Exit Device Series	ED6600	Corbin Russwin	3126-1/2 796-1/2	3126-1/2NT NT796-1/2
Number of Mortise Lock Body	MLE03		MLE04	MLE05

Item	Part No.	Description
S/A		Crossbar Lock Body (No Cylinder or Trim) for
	424F50-8	MLE03 & MLE04
	424F52-8	MLE05
1	535F05-8	Case & Front Sub Assembly
2	424F37-8	Cap, Case
10	467F18-8	Latchbolt
14	236F17-8	Spring, Locking Lever
15	402F93-7	Latch, 5/16" Auxiliary
16	426F47-8	Lever, Auxiliary Latch
17	426F48-8	Spring, Auxiliary Latch Lever
18	424F34-8	Lever, Hub
22	362F06-8	Lever, Cylinder Latch
25	685F38-7	Spring, Stopworks
31	402F73-8	Bracket, Cylinder Set Screw
34		Lever, Hold Back for
	398F14-9	MLE03 & MLE04
	398F15-9	MLE05 - RHR
	398F16-9	MLE05 - LHR

Item	Part No.	Description
35	684F18-8	Screw, FHUM-PH-TITE #8-32 x 3/8"
42	466F86-8	Lever, Locking
50	<i>Specify Finish</i> 611F20	Armored Front
51	<i>Specify Finish</i>	Strike (See page 74 for listing)
52	<i>Specify Finish</i> 429F41	Mortise Lock Mounting Packet for Standard (See page 109 for packet descriptions)
60	483F43-8	Lever, Latch
61	363F52-8	Spring, Thumbturn Lever
62	424F33-8	Lever, Thumbturn
65	345F52-8	Lever, Thumbturn Latch
66	345F53-8	Lever, Connecting
67	379F51-8	Hub
68	424F13-8	Washer, Hold
69	132F89-3	Spring

The warranty on Corbin Russwin products becomes void if the product is modified in any way, regardless of whether the modifications causes or contributes to any alleged defect. If a Corbin Russwin product is modified it may no longer meet industry certification and quality control standards applicable to the original product and is no longer a genuine Corbin Russwin product.

Copyright © 2000-2020, ASSA ABLOY Access and Egress Hardware Group, Inc. All rights reserved. Reproduction in whole or in part without the express written permission of ASSA ABLOY Access and Egress Hardware Group, Inc. is prohibited. Patent pending and/or patent www.assaabloydss.com/patents.

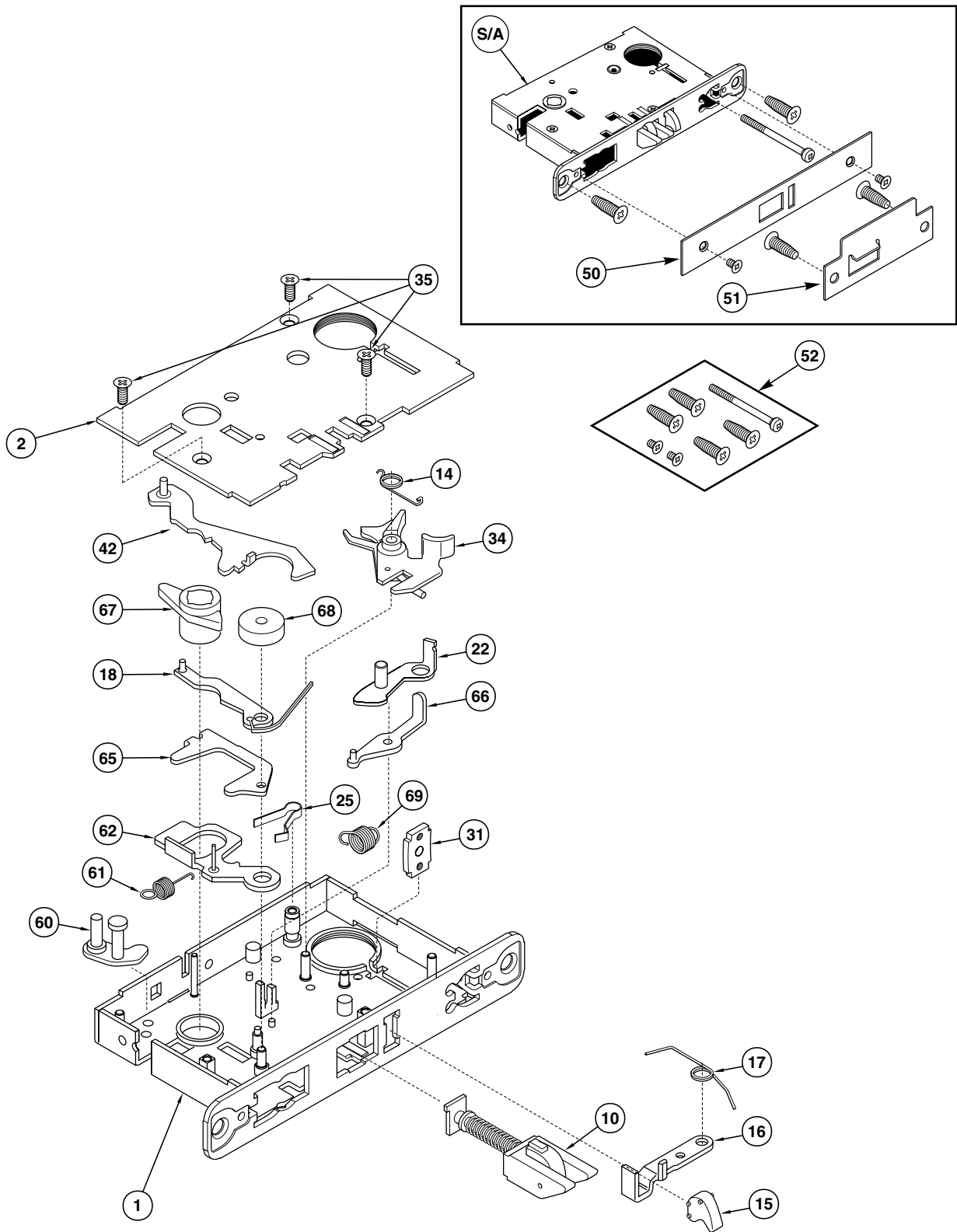

The warranty on Corbin Russwin products becomes void if the product is modified in any way, regardless of whether the modifications causes or contributes to any alleged defect. If a Corbin Russwin product is modified it may no longer meet industry certification and quality control standards applicable to the original product and is no longer a genuine Corbin Russwin product.

Copyright © 2000-2020, ASSA ABLOY Access and Egress Hardware Group, Inc. All rights reserved. Reproduction in whole or in part without the express written permission of ASSA ABLOY Access and Egress Hardware Group, Inc. is prohibited. Patent pending and/or patent www.assaabloydss.com/patents.

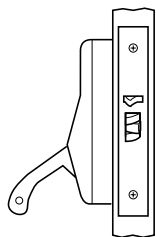

NOTE:
MLE06 (no trim)
function side view
shown as example.

		To Support Discontinued Double Cyl. Devices	
Exit Device Series	ED6600A	Corbin Russwin	3126-1/2 U796-1/2
Number of Mortise Lock Body	MLE06		MLE07

Item	Part No.	Description
S/A	<i>Specify Finish</i>	
	424F51-8	Crossbar Lock Body (No Cylinder or Trim)
1	535F05-8	Case & Front Sub Assembly
2	424F37-8	Cap, Case
10	467F18-26	Latchbolt
14	236F17-8	Spring, Locking Lever
15	402F93-7	Latch, 5/16" Auxiliary
16	426F47-8	Lever, Auxiliary Latch
17	426F48-8	Spring, Auxiliary Latch Lever
18	424F34-8	Lever, Hub
22	362F06-8	Lever, Cylinder Latch
25	685F38-7	Spring, Stopworks
31	402F73-8	Bracket, Cylinder Set Screw
33	397F35-9	Lever, Cylinder Stop

Item	Part No.	Description
35	684F18-8	Screw, FHUM-PH-TITE #8-32 x 3/8"
42	466F86-8	Lever, Locking
50	<i>Specify Finish</i>	
	611F20	Armored Front
51	405L14 018	Std. Strike (See page 76 for listing)
52	<i>Specify Finish</i>	
	429F41	Mortise Lock Mounting Packet (See page 109 for packet descriptions)
60	483F43-8	Lever, Latch
61	363F52-8	Spring, Thumbturn Lever
62	424F33-8	Lever, Thumbturn
65	345F52-8	Lever, Thumbturn Latch
66	345F53-8	Lever, Connecting
67	379F51-8	Hub
68	424F13-8	Washer, Hold

The warranty on Corbin Russwin products becomes void if the product is modified in any way, regardless of whether the modifications causes or contributes to any alleged defect. If a Corbin Russwin product is modified it may no longer meet industry certification and quality control standards applicable to the original product and is no longer a genuine Corbin Russwin product.

Copyright © 2000-2020, ASSA ABLOY Access and Egress Hardware Group, Inc. All rights reserved. Reproduction in whole or in part without the express written permission of ASSA ABLOY Access and Egress Hardware Group, Inc. is prohibited. Patent pending and/or patent www.assaabloydss.com/patents.

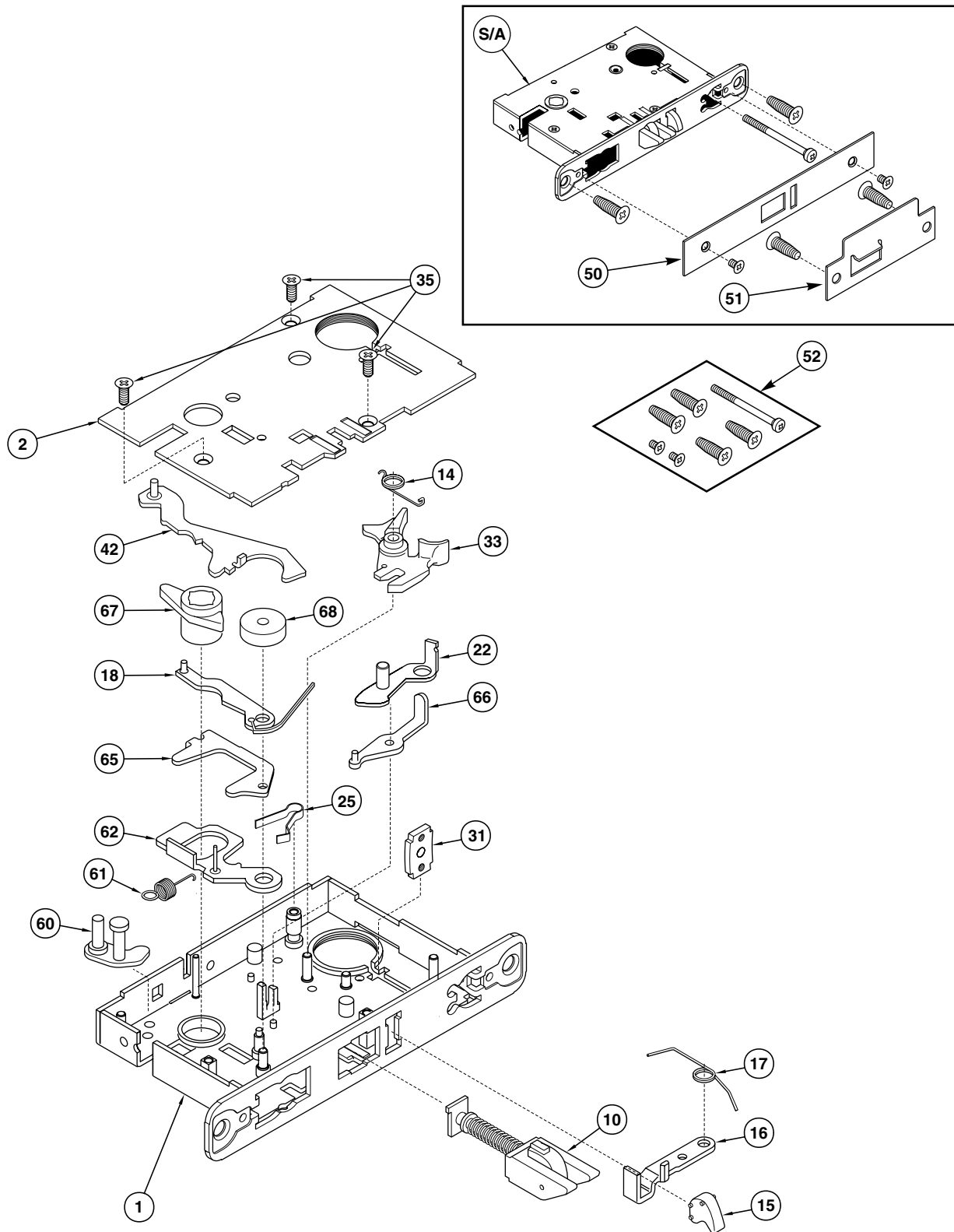

The warranty on Corbin Russwin products becomes void if the product is modified in any way, regardless of whether the modifications causes or contributes to any alleged defect. If a Corbin Russwin product is modified it may no longer meet industry certification and quality control standards applicable to the original product and is no longer a genuine Corbin Russwin product.

Copyright © 2000-2020, ASSA ABLOY Access and Egress Hardware Group, Inc. All rights reserved. Reproduction in whole or in part without the express written permission of ASSA ABLOY Access and Egress Hardware Group, Inc. is prohibited. Patent pending and/or patent www.assaabloydss.com/patents.

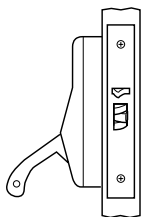

NOTE:
MLE08 (no trim)
function side view
shown as example.

Exit Device Series	ED7600	ED7600A
Number of Mortise Lock Body	MLE08	MLE09

Item	Part No.	Description
S/A	<i>Specify Finish</i> 424F42-8 424F43-8	Crossbar Lock Body (No Cylinder or Trim) for MLE08 MLE09
1	535F19-8	Case & Front Sub Assembly
2	424F36-8	Cap, Case
10	467F18-8	Latchbolt
14	236F17-8	Spring, Locking Lever
15	402F93-7	Latch, 5/16" Auxiliary
16	426F47-8	Lever, Auxiliary Latch
17	426F48-8	Spring, Auxiliary Latch Lever
18	424F34-8	Lever, Hub
22	362F06-8	Lever, Cylinder Latch
25	685F38-7	Spring, Stopworks
31	402F73-8	Bracket, Cylinder Set Screw
33	397F35-9	Lever, Cylinder Stop

Item	Part No.	Description
35	684F18-8	Screw, FHUM-PH-TITE #8-32 x 3/8"
42	466F86-8	Lever, Locking
50	<i>Specify Finish</i> 611F20	Armored Front
51	405L14 018	Std. Strike (See page 76 for listing)
52	<i>Specify Finish</i> 429F41	Mortise Lock Mounting Packet (See page 109 for packet descriptions)
60	424F35-8	Lever, Latch
61	363F52-8	Spring, Thumbturn Lever
63	440F72-8	Lever, Bottom Thumbturn
64	440F73-8	Lever, Top Thumbturn
65	363F34-8	Lever, Thumbturn Latch
66	345F53-8	Lever, Connecting
68	424F13-8	Washer, Hold
69	132F89-3	Spring
70	424F32-8	Lever, Auxiliary

The warranty on Corbin Russwin products becomes void if the product is modified in any way, regardless of whether the modifications causes or contributes to any alleged defect. If a Corbin Russwin product is modified it may no longer meet industry certification and quality control standards applicable to the original product and is no longer a genuine Corbin Russwin product.

Copyright © 2000-2020, ASSA ABLOY Access and Egress Hardware Group, Inc. All rights reserved. Reproduction in whole or in part without the express written permission of ASSA ABLOY Access and Egress Hardware Group, Inc. is prohibited. Patent pending and/or patent www.assaabloydss.com/patents.

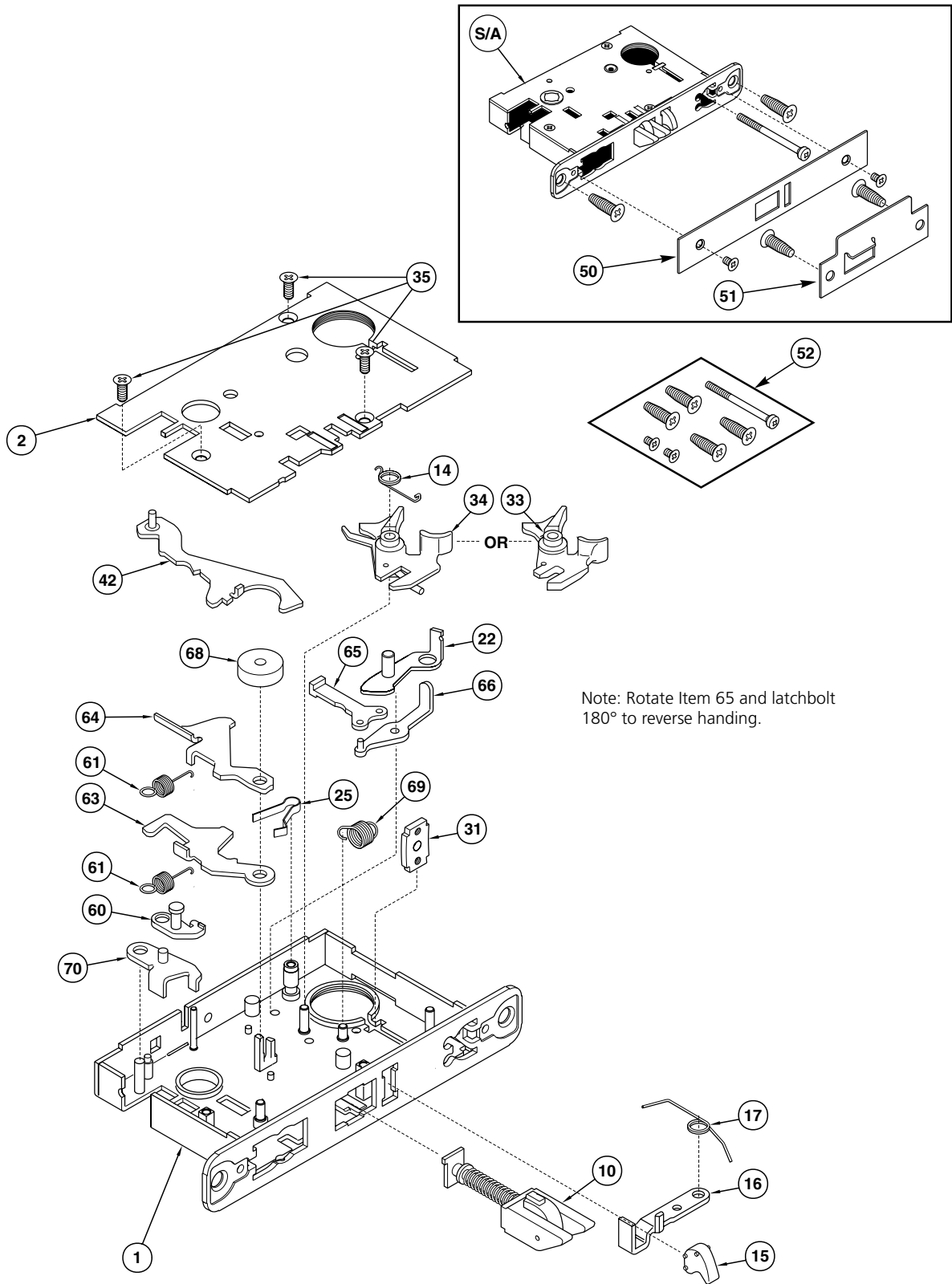

The warranty on Corbin Russwin products becomes void if the product is modified in any way, regardless of whether the modifications causes or contributes to any alleged defect. If a Corbin Russwin product is modified it may no longer meet industry certification and quality control standards applicable to the original product and is no longer a genuine Corbin Russwin product.

Copyright © 2000-2020, ASSA ABLOY Access and Egress Hardware Group, Inc. All rights reserved. Reproduction in whole or in part without the express written permission of ASSA ABLOY Access and Egress Hardware Group, Inc. is prohibited. Patent pending and/or patent www.assaabloydss.com/patents.

(Specialty Finish)

Lip Length	Latchbolt & Deadbolt			Latchbolt			Deadbolt	Filler Plate
	Straight Lip	Curved Lip RH/LHR	Curved Lip LH/RHR	Straight Lip	Curved Lip RH/LHR	Curved Lip LH/RHR	Straight Lip	Straight Lip
7/8"	236L72014	-----	-----	236L73014	-----	-----	236L74014	-----
1"	236L72016	-----	-----	236L73016	-----	-----	236L74016	236L70016
1-1/8"	236L72018	340L60018	340L61018	236L73018	340L62018	340L63018	236L74018	236L70018
1-1/4"	236L72020	340L60020	340L61020	236L73020	340L62020	340L63020	236L74020	236L70020
1-3/8"	236L72022	340L60022	340L61022	236L73022	340L62022	340L63022	236L74022	236L70022
1-1/2"	236L72024	340L60024	340L61024	236L73024	340L62024	340L63024	236L74024	236L70024
1-3/4"	236L72028	340L60028	340L61028	236L73028	340L62028	340L63028	236L74028	236L70028
2"	236L72032	340L60032	340L61032	236L73032	340L62032	340L63032	236L74032	236L70032
2-1/4"	236L72036	340L60036	340L61036	236L73036	340L62036	340L63036	236L74036	236L70036
2-1/2"	236L72040	340L60040	340L61040	236L73040	340L62040	340L63040	236L74040	236L70040
2-3/4"	236L72044	340L60044	340L61044	236L73044	340L62044	340L63044	236L74044	236L70044
3"	236L72048	340L60048	340L61048	236L73048	340L62048	340L63048	236L74048	236L70048

NOTE: On Curved Lip Strikes, the lip length will always be 1/8" longer than the lip length of Straight Lip Strikes for the same door thickness.
 Example: for 1-3/4" door thickness order Straight Lip Strike in 1-1/8" lip length (236L72018) or Curved Lip Strike in 1-1/4" lip length (340L60020).

Open back Strike			Exit Device Strike			Wrought Box
Door Thickness	LHR	RHR	Lip Length	LHR	RHR	Wrought Box is available for all ANSI standardized strikes.
1-3/4" (016)	411L62016	411L63016	1-1/8"	405L138018	405L148018	
2" (018)	411L62018	411L63018	1-1/4"	405L138020	405L148020	
2-1/4" (020)	411L62020	411L63020	1-3/8"	405L138022	405L148022	

The warranty on Corbin Russwin products becomes void if the product is modified in any way, regardless of whether the modifications causes or contributes to any alleged defect. If a Corbin Russwin product is modified it may no longer meet industry certification and quality control standards applicable to the original product and is no longer a genuine Corbin Russwin product.

Copyright © 2000-2020, ASSA ABLOY Access and Egress Hardware Group, Inc. All rights reserved. Reproduction in whole or in part without the express written permission of ASSA ABLOY Access and Egress Hardware Group, Inc. is prohibited. Patent pending and/or patent www.assaabloydss.com/patents.

1 Case & Front Sub Assembly

- 687F53-8* (Standard)
- 687F54-8 (D138 Option)
- 687F58-8 (MR Option)

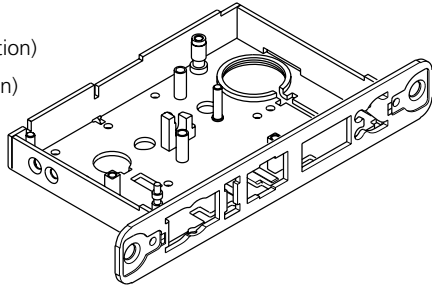

- 687F55-8* (Standard)
- 687F56-8 (D138 Option)

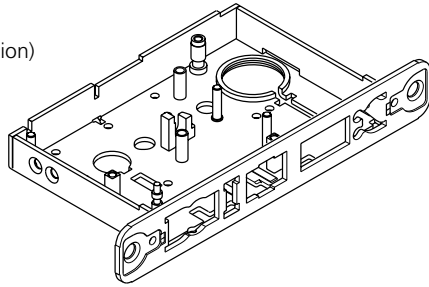

- 535F05-8 (Crossbar Versions)
- 687F56-8 Series &
- ED6600A Series

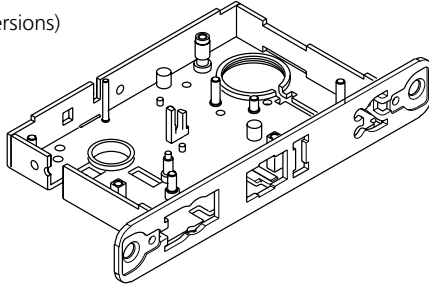

- 535F19-8 (Crossbar Versions)
- ED7600 Series &
- ED7600A Series

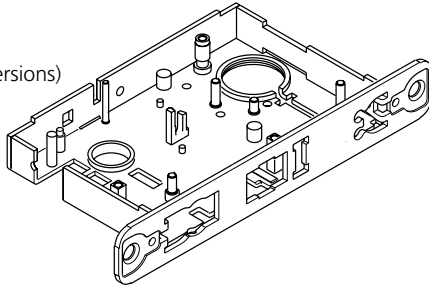

- 547F46-8 (RHR)
- 547F47-8 (LHR)
- (All Pushbar Series)

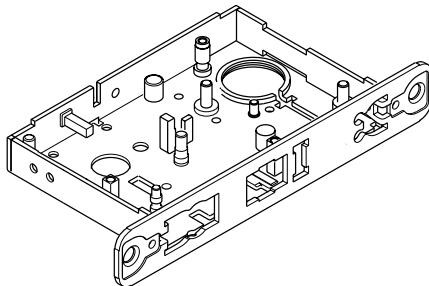

2 Case Caps

- 700F27-8* (Standard & HS)
- 700F57-8* (MR Option)

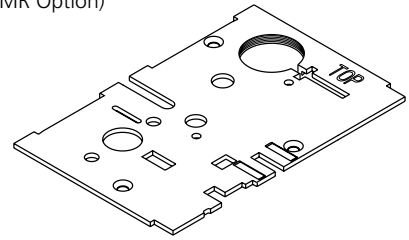

- 424F37-8 (Crossbar Versions)
- ED6600 Series &
- ED6600A Series

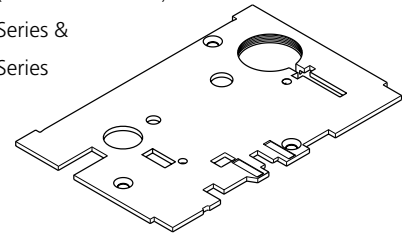

- 424F36-8 (Crossbar Versions)
- ED7600 Series &
- ED7600A Series

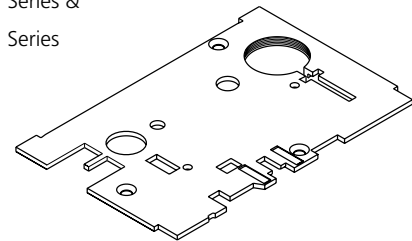



*For M26 Option, replace suffix "-8" with "-2".

The warranty on Corbin Russwin products becomes void if the product is modified in any way, regardless of whether the modifications causes or contributes to any alleged defect. If a Corbin Russwin product is modified it may no longer meet industry certification and quality control standards applicable to the original product and is no longer a genuine Corbin Russwin product.

Copyright © 2000-2020, ASSA ABLOY Access and Egress Hardware Group, Inc. All rights reserved. Reproduction in whole or in part without the express written permission of ASSA ABLOY Access and Egress Hardware Group, Inc. is prohibited. Patent pending and/or patent www.assaabloydss.com/patents.

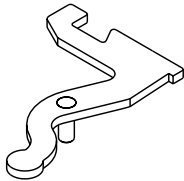
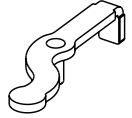
3 Stop Levers

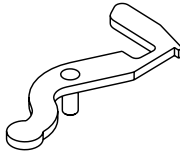
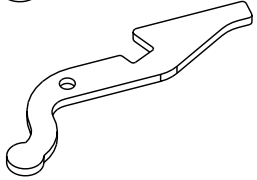
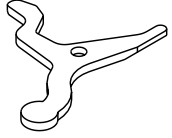
- 682F01-8 (Standard) 
- 681F44-8 (Standard)
- 681F44-2 (M26 Option)
- 402F77-8 (Exit Device) 
- 700F74-8 (Standard)
- 700F74-2 (M26 Option) 
- 624F47-8 (Standard)
- 624F47-2 (M26 Option) 
- 700F70-8 (Standard)
- 700F70-2 (M26 Option) 
- 700F25-8 (Standard)
- 700F25-2 (M26 Option) 

4 Knob Hub

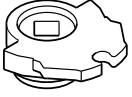
- 684F14-7 (Standard) 
- 683F33-7 (High Security) 

5 Hub (Case Side)

- 684F10-8 (Standard) 
- 684F10-7 (M26 Option) (VR)

6 Hub (Cap Side)

- 684F09-8 (Standard) 
- 684F09-7 (M26 Option) (VR)

7 Stop

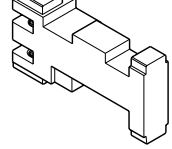
- 684F05-5 (Standard) 

8 Fixed Stop

- 684F55-9 

9 Turnpiece Hub

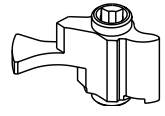
- 700F23-5 (Standard) 
- 700F31-5 (MR Option)
- 624F44-5 

10 Latchbolt

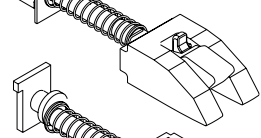
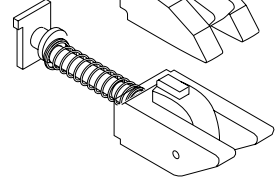
- 688F17-7 (Standard) 
- 467F18-8 (Exit Device) 

11 Deadbolt

- 702F98-7 

12 Deadbolt Spring

- 701F22-8 

The warranty on Corbin Russwin products becomes void if the product is modified in any way, regardless of whether the modifications causes or contributes to any alleged defect. If a Corbin Russwin product is modified it may no longer meet industry certification and quality control standards applicable to the original product and is no longer a genuine Corbin Russwin product.

Copyright © 2000-2020, ASSA ABLOY Access and Egress Hardware Group, Inc. All rights reserved. Reproduction in whole or in part without the express written permission of ASSA ABLOY Access and Egress Hardware Group, Inc. is prohibited. Patent pending and/or patent www.assaabloydss.com/patents.

13 Deadlocking Lever

- 602F19-8 (Standard)
- 602F19-7 (M26 Option)

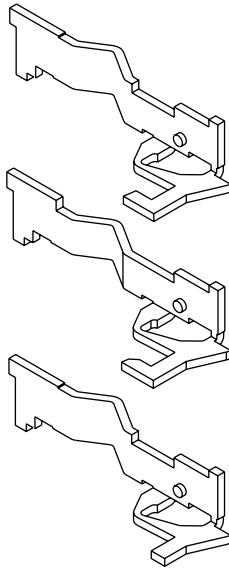

- 700F21-8 (Standard)
- 700F21-2 (M26 Option)

- 624F48-8 (Standard)
- 624F48-2 (M26 Option)

18 Hub Lever

- 681F36-8 (Standard)
- 681F36-2 (M26 Option)

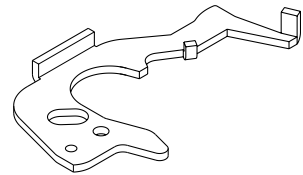

- 681F37-8 (Standard)
- 681F37-2 (M26 Option)

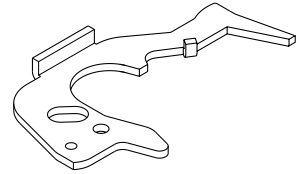

- 536F64-8 (Exit Device)

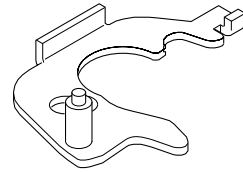

- 424F34-8 (Exit Device)

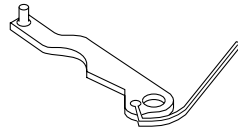

14 Deadlocking Lever Spring

- 700F90-7 (Standard)
- 236F17-8 (Exit Device)

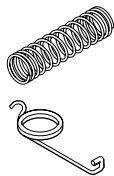

15 Auxiliary Latches

- 403F67-7 (Standard)

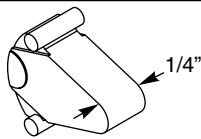

- 402F93-7 625 (Exit Device)

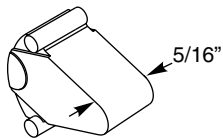

19 Retractor

- 688F03-8 (Standard)
- 688F03-7 (M26 Option)

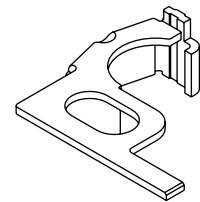

16 Auxiliary Levers

- 678F54-8 (Standard)
- 678F54-2 (M26 Option)

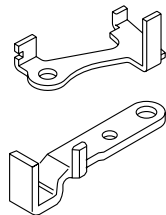

- 426F47-8 (Exit Device)

20 Retractor Spring

- 690F82-7 (Standard)

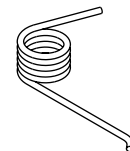

17 Auxiliary Lever Spring

- 678F67-7 (Standard)

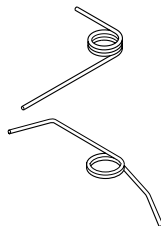

- 426F48-8 (Exit Device)

The warranty on Corbin Russwin products becomes void if the product is modified in any way, regardless of whether the modifications causes or contributes to any alleged defect. If a Corbin Russwin product is modified it may no longer meet industry certification and quality control standards applicable to the original product and is no longer a genuine Corbin Russwin product.

Copyright © 2000-2020, ASSA ABLOY Access and Egress Hardware Group, Inc. All rights reserved. Reproduction in whole or in part without the express written permission of ASSA ABLOY Access and Egress Hardware Group, Inc. is prohibited. Patent pending and/or patent www.assaabloydss.com/patents.

21 Hub Lever pring

- 565F04-8 (Standard)
- 565F04-7 (M26 Option)

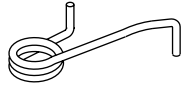

30 Lever Return Spring

- 404F85-8 (Standard)
- 404F85-7 (M26 Option)

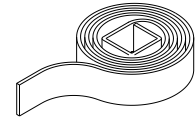

22 Cylinder Latch Levers

- 688F14-8 (Standard)
- 688F14-2 (M26 Option)

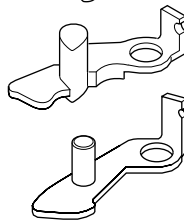
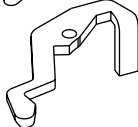
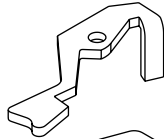

- 700F22-8 (Standard)
- 700F22-2 (M26 Option)

- 536F59-8 (Exit Device)

- 362F06-8 (Exit Device)

31 Cylinder Set Screw Bracket

- 402F73-8 (Standard)
- 402F73-2 (M26 Option)

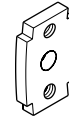

32 Align Bracket

- 404F86-8 (Standard)
- 402F86-2 (M26 Option)

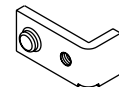

33 Stop Cylinder Lever

- 701F70-5 (Standard)

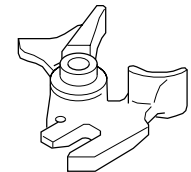
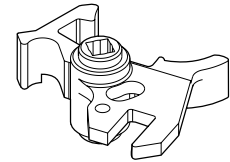

- 397F35-9 (Exit Device)

23 Cylinder Latch Lever Stop

- 681F48-9 (Standard)



24 Retaining Ring

- 436F17-7



25 Stop Spring

- 685F38-7 (Standard)

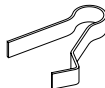

34 Holdback Lever

- 398F14-9 (Exit Device)
- 398F15-9 (Exit Device)
- 398F16-9 (Exit Device)

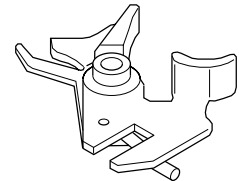

26 Toggle Sub Assembly

- 461F01-7



35 Screw, FHUM-PH-TITE #8-32 x 3/8"

- 425F86-8 (Standard)
- 425F86-7 (M26 Option)



27 Toggle Spring

- 402F63-7



36 Hub Spacer

- 684F11-9 (Lever x Lever Trim)



28 Seat Spring

- 402F61-7



37 Spring Spacer

- 684F12-9



29 Spacer

- 466F22-9



38 Stop Screw

- 684F06-7



The warranty on Corbin Russwin products becomes void if the product is modified in any way, regardless of whether the modifications causes or contributes to any alleged defect. If a Corbin Russwin product is modified it may no longer meet industry certification and quality control standards applicable to the original product and is no longer a genuine Corbin Russwin product.

Copyright © 2000-2020, ASSA ABLOY Access and Egress Hardware Group, Inc. All rights reserved. Reproduction in whole or in part without the express written permission of ASSA ABLOY Access and Egress Hardware Group, Inc. is prohibited. Patent pending and/or patent www.assaabloydss.com/patents.

41 Identification Label

685F17-9

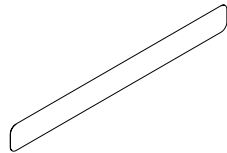

42 Locking Lever

466F86-8 (Exit Device)

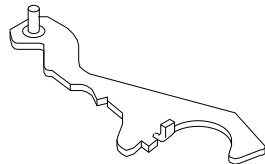

43 Hold Back Lever

681F07-5

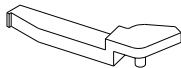

44 Spring

624F42-7

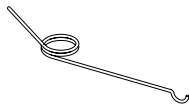

45 Spacer

624F43-9



46 Spacer

624F44-9



47 Spring, Kickoff

688F01-7



48 Spring

403F56-8 (Standard)

403F56-2 (M26 Option)



49 Lever, Locking

403F66-8



50 Armored Fronts

Specify Finish

For Deadbolt Only

079F00 (Standard)

079F02 (D138 Option)

For Deadbolt & Latchbolt

423F54 (Standard)

423F57 (D138 Option)

For Latchbolt Only

423F55 (Standard)

423F58 (D138 Option)

For Deadbolt, Latchbolt,
& Auxiliary Latch

402F30 (Standard)

402F34 (D138 Option)

For Latchbolt,
& Auxiliary Latch

624F49 (Standard)

624F53 (D138 Option)

681F34 (LHB Std.)

681F35 (LHB x D138)

For Deadbolt, Latchbolt,
& Toggle

402F31 (Standard)

402F35 (D138 Option)

For Latchbolt, Auxiliary
Latch, & Toggle

681F31 (Standard)

681F30 (D138 Option)

681F41 (LHB Std.)

681F40 (LHB x D138)

For Deadbolt, Latchbolt,
Auxiliary Latch, & Toggle

402F29 (Standard)

402F33 (D138 Option)

For Exit Devices Latchbolt,
& Auxiliary Latch

611F20 (Standard)

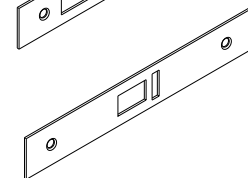
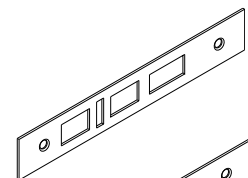
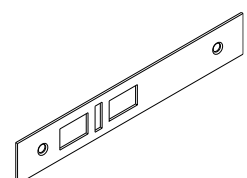
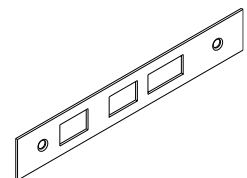
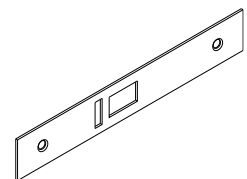
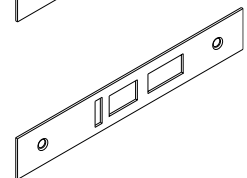
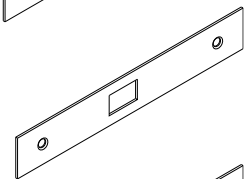
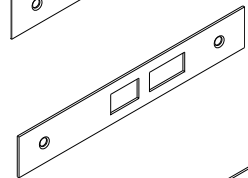
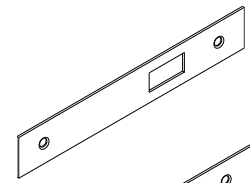

The warranty on Corbin Russwin products becomes void if the product is modified in any way, regardless of whether the modifications causes or contributes to any alleged defect. If a Corbin Russwin product is modified it may no longer meet industry certification and quality control standards applicable to the original product and is no longer a genuine Corbin Russwin product.

Copyright © 2000-2020, ASSA ABLOY Access and Egress Hardware Group, Inc. All rights reserved. Reproduction in whole or in part without the express written permission of ASSA ABLOY Access and Egress Hardware Group, Inc. is prohibited. Patent pending and/or patent www.assaabloydss.com/patents.

Strikes see pg 51

52 Mounting Packet

- 429F41 (Standard)
- 488F09 (MR Option)
- 465F57 (High Security, M04, Vandal Resistant)

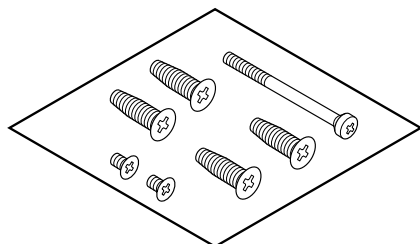

53 Spring, Latch Lever

700F95-7

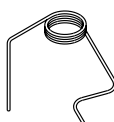

54 Spring, Stop

703F99-7

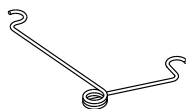

60 Latch Lever

424F35-8 (Exit Device)

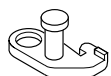

483F43-8 (Exit Device)

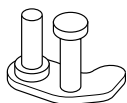

61 Thumbturn Lever Spring

363F52-8 (Exit Device)



62 Thumbturn Lever

424F33-8 (Exit Device)

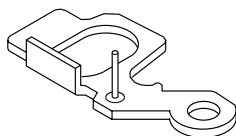

63 Bottom Thumbturn Lever

440F72-8 (Exit Device)

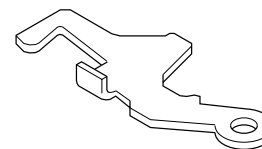

64 Top Thumbturn Lever

440F73-8 (Exit Device)

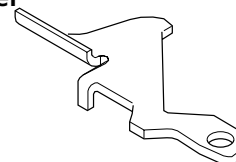

65 Thumbturn Latch Lever

363F34-8 (Exit Device)

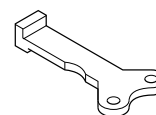

345F52-8 (Exit Device)

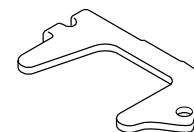

66 Connecting Lever

345F53-8 (Exit Device)

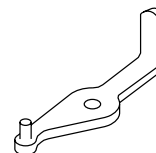

67 Hub

379F51-8 (Exit Device)

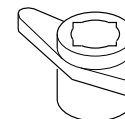

68 Hold Washer

424F13-8 (Exit Device)



69 Spring

132F89-3 (Exit Device)



70 Auxiliary Lever

424F32-8 (Exit Device)

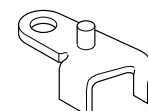

The warranty on Corbin Russwin products becomes void if the product is modified in any way, regardless of whether the modifications causes or contributes to any alleged defect. If a Corbin Russwin product is modified it may no longer meet industry certification and quality control standards applicable to the original product and is no longer a genuine Corbin Russwin product.

Copyright © 2000-2020, ASSA ABLOY Access and Egress Hardware Group, Inc. All rights reserved. Reproduction in whole or in part without the express written permission of ASSA ABLOY Access and Egress Hardware Group, Inc. is prohibited. Patent pending and/or patent www.assaabloydss.com/patents.



Lever x Wrought Escutcheon

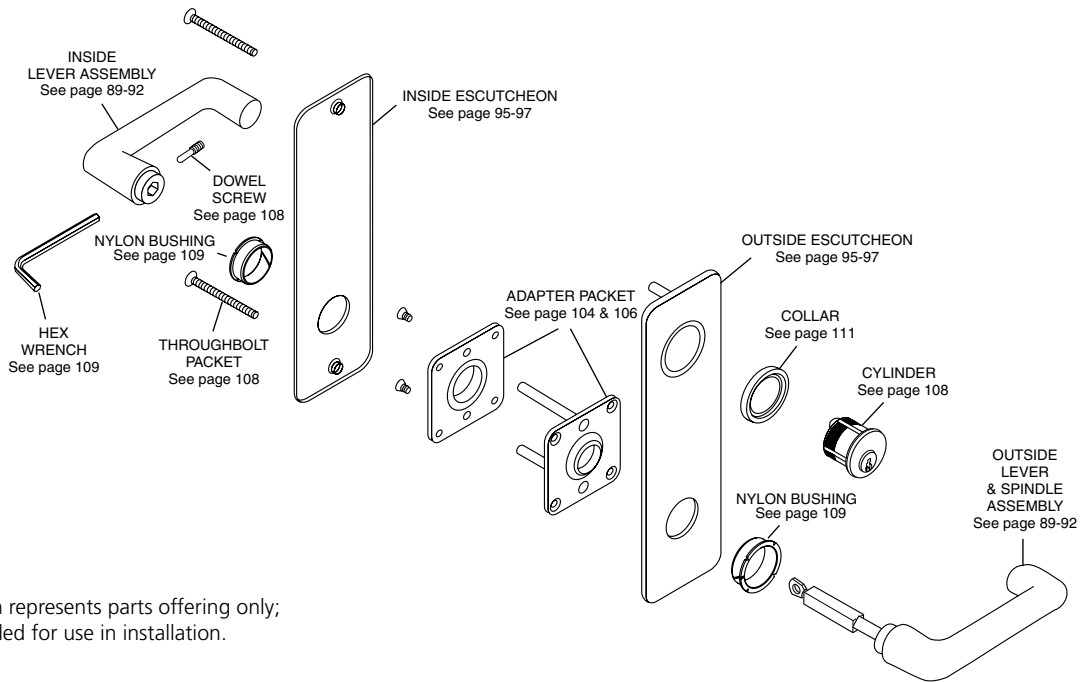

Illustration represents parts offering only; not intended for use in installation.

Wrought Knob x Wrought Escutcheon

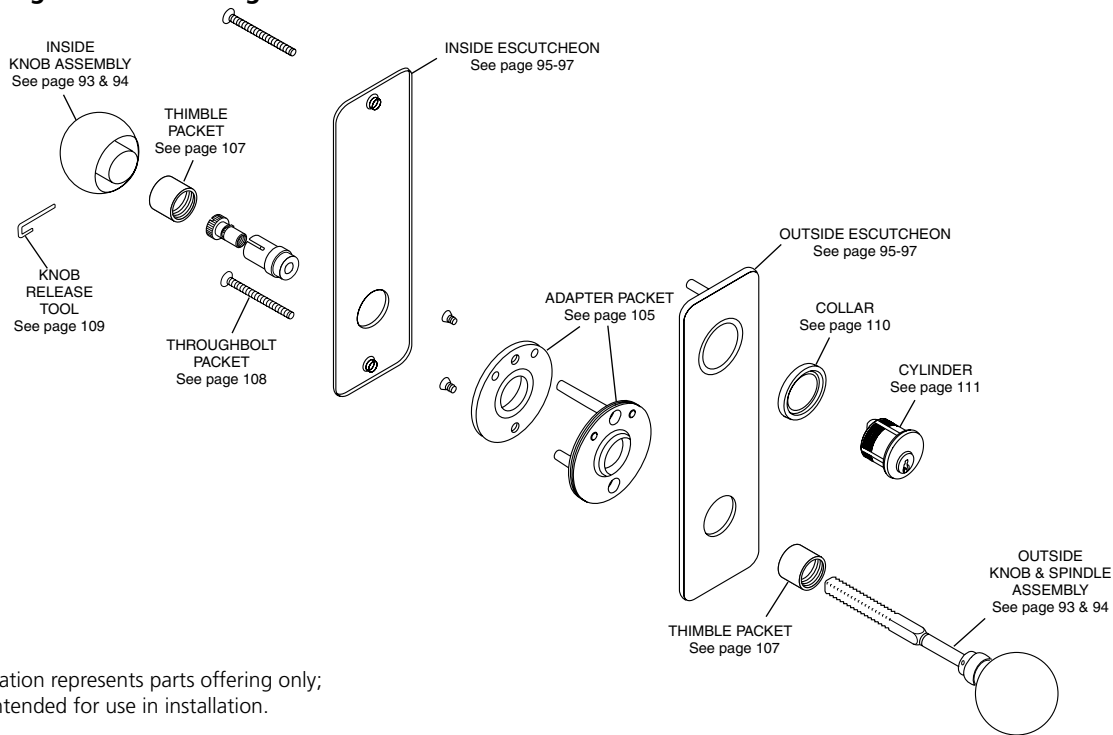

Illustration represents parts offering only; not intended for use in installation.

The warranty on Corbin Russwin products becomes void if the product is modified in any way, regardless of whether the modifications causes or contributes to any alleged defect. If a Corbin Russwin product is modified it may no longer meet industry certification and quality control standards applicable to the original product and is no longer a genuine Corbin Russwin product.

Copyright © 2000-2020, ASSA ABLOY Access and Egress Hardware Group, Inc. All rights reserved. Reproduction in whole or in part without the express written permission of ASSA ABLOY Access and Egress Hardware Group, Inc. is prohibited. Patent pending and/or patent www.assaabloydss.com/patents.



Lever x Cast Escutcheon*

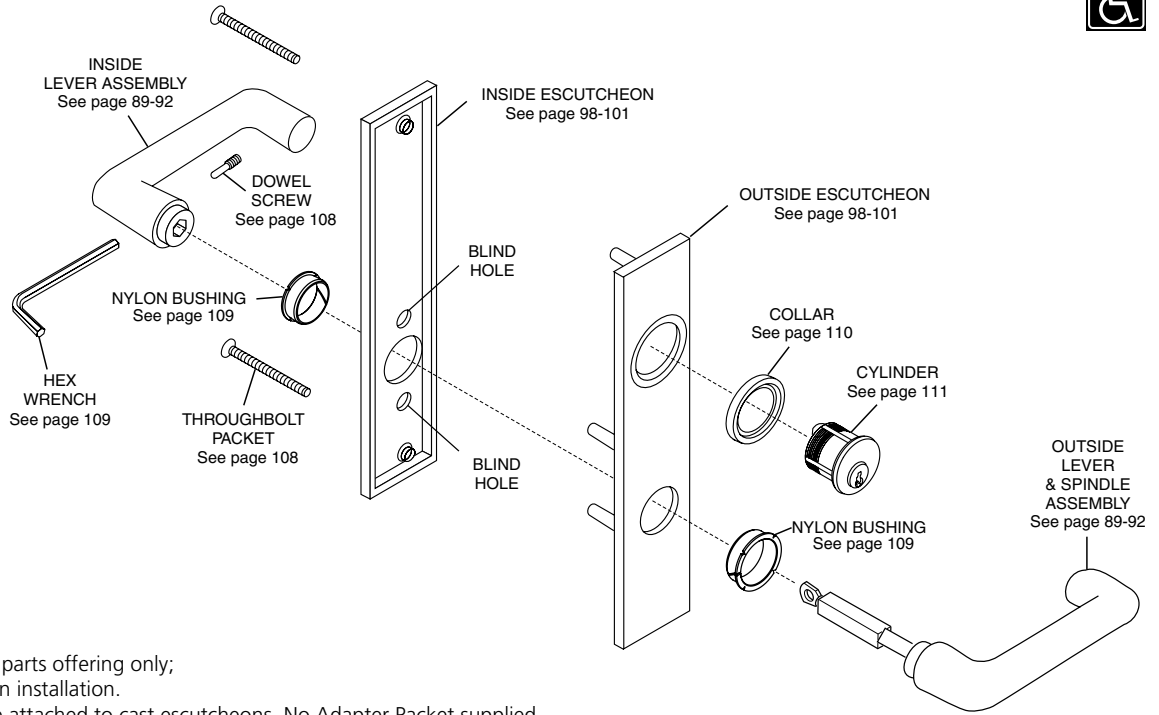

Illustration represents parts offering only; not intended for use in installation.
 *Throughbolt lugs are attached to cast escutcheons. No Adapter Packet supplied.

**Vandal Resistant Lever Trim
 Cast Lever x Cast Escutcheon***

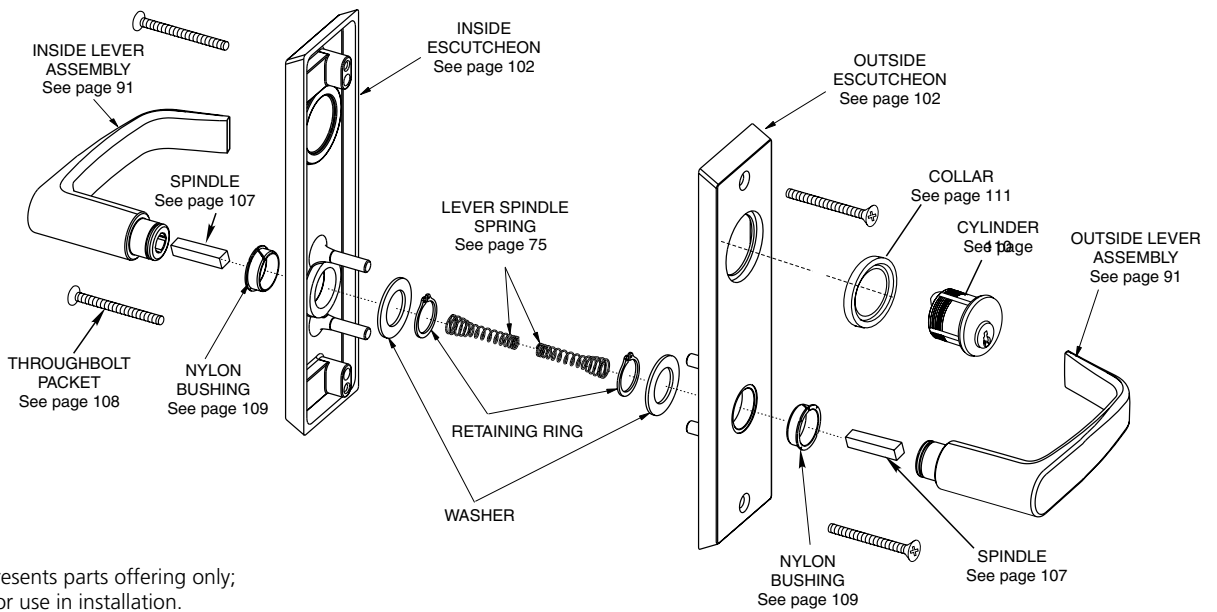

Illustration represents parts offering only; not intended for use in installation.
 *Throughbolt lugs are attached to cast escutcheons. No Adapter Packet supplied.

The warranty on Corbin Russwin products becomes void if the product is modified in any way, regardless of whether the modifications causes or contributes to any alleged defect. If a Corbin Russwin product is modified it may no longer meet industry certification and quality control standards applicable to the original product and is no longer a genuine Corbin Russwin product.

Copyright © 2000-2020, ASSA ABLOY Access and Egress Hardware Group, Inc. All rights reserved. Reproduction in whole or in part without the express written permission of ASSA ABLOY Access and Egress Hardware Group, Inc. is prohibited. Patent pending and/or patent www.assaabloyds.com/patents.

Cast Knob x Cast Escutcheon*

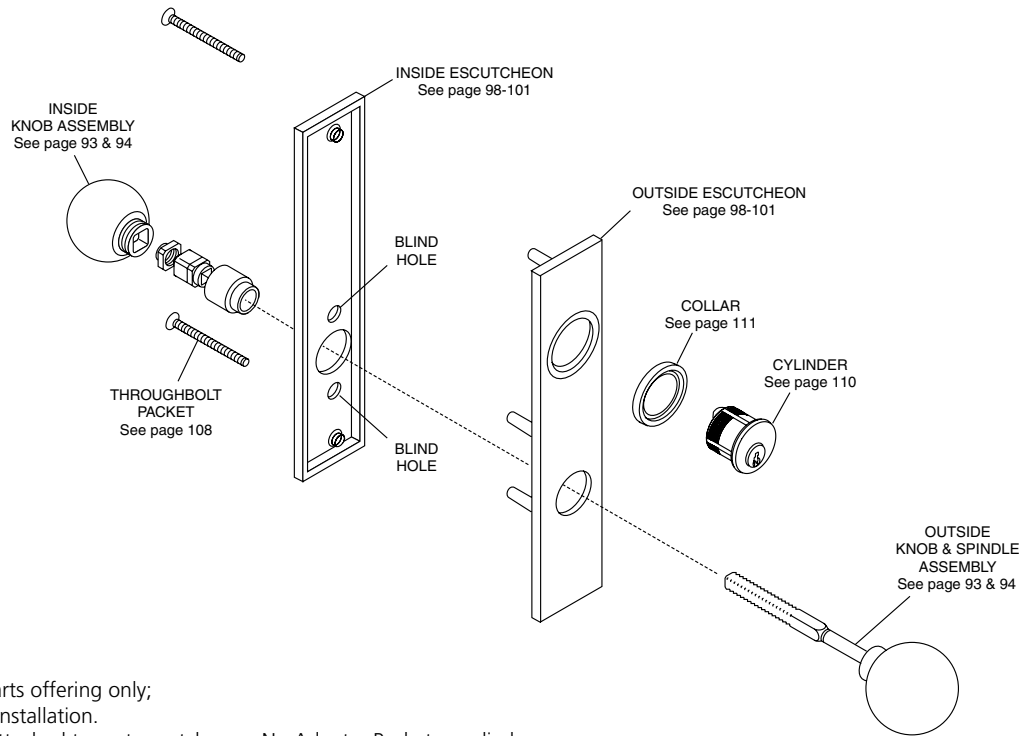

Illustration represents parts offering only;
not intended for use in installation.
*Throughbolt lugs are attached to cast escutcheons. No Adapter Packet supplied.

Lever x Rose

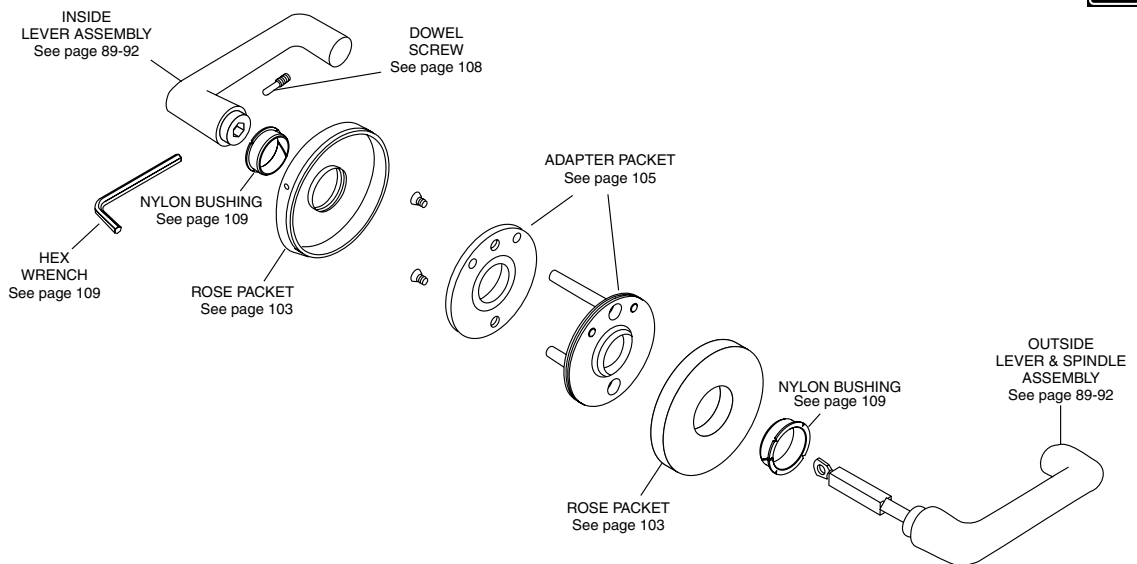

Illustration represents parts offering only;
not intended for use in installation.

The warranty on Corbin Russwin products becomes void if the product is modified in any way, regardless of whether the modifications causes or contributes to any alleged defect. If a Corbin Russwin product is modified it may no longer meet industry certification and quality control standards applicable to the original product and is no longer a genuine Corbin Russwin product.

Copyright © 2000-2020, ASSA ABLOY Access and Egress Hardware Group, Inc. All rights reserved. Reproduction in whole or in part without the express written permission of ASSA ABLOY Access and Egress Hardware Group, Inc. is prohibited. Patent pending and/or patent www.assaabloydss.com/patents.

Wrought Knob x Rose

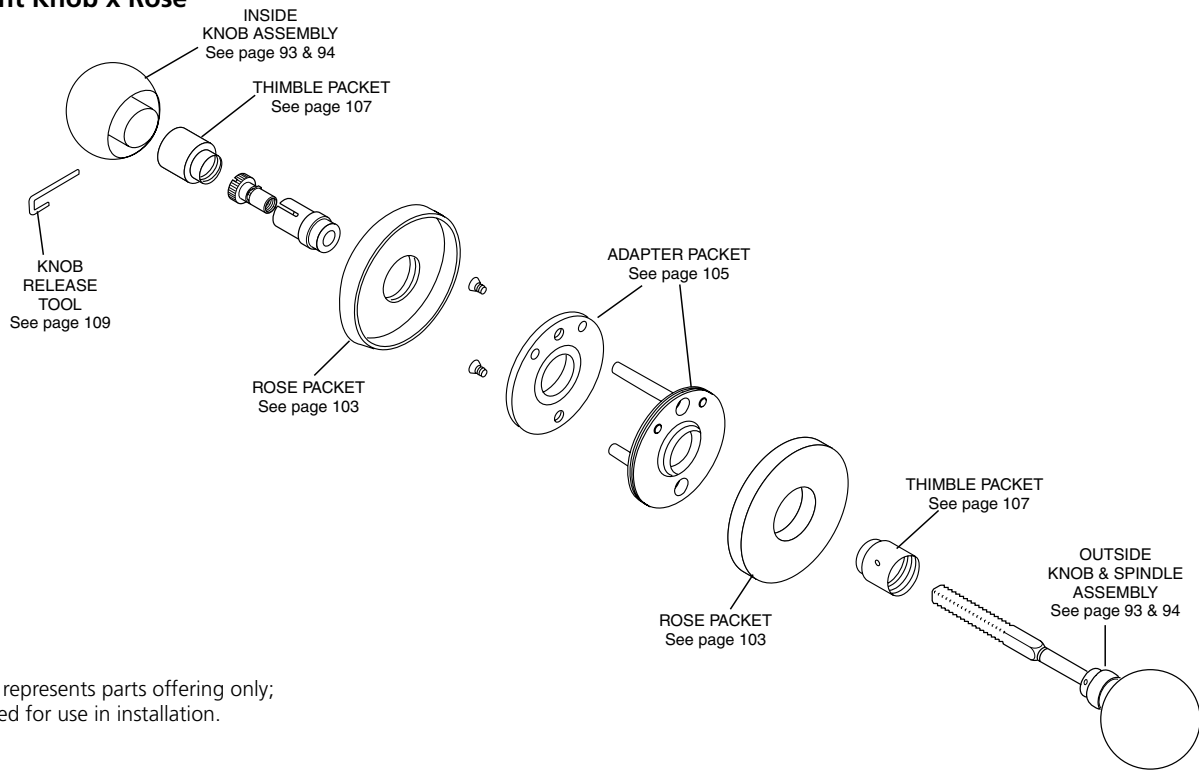

Illustration represents parts offering only; not intended for use in installation.

Cast Knob x Rose

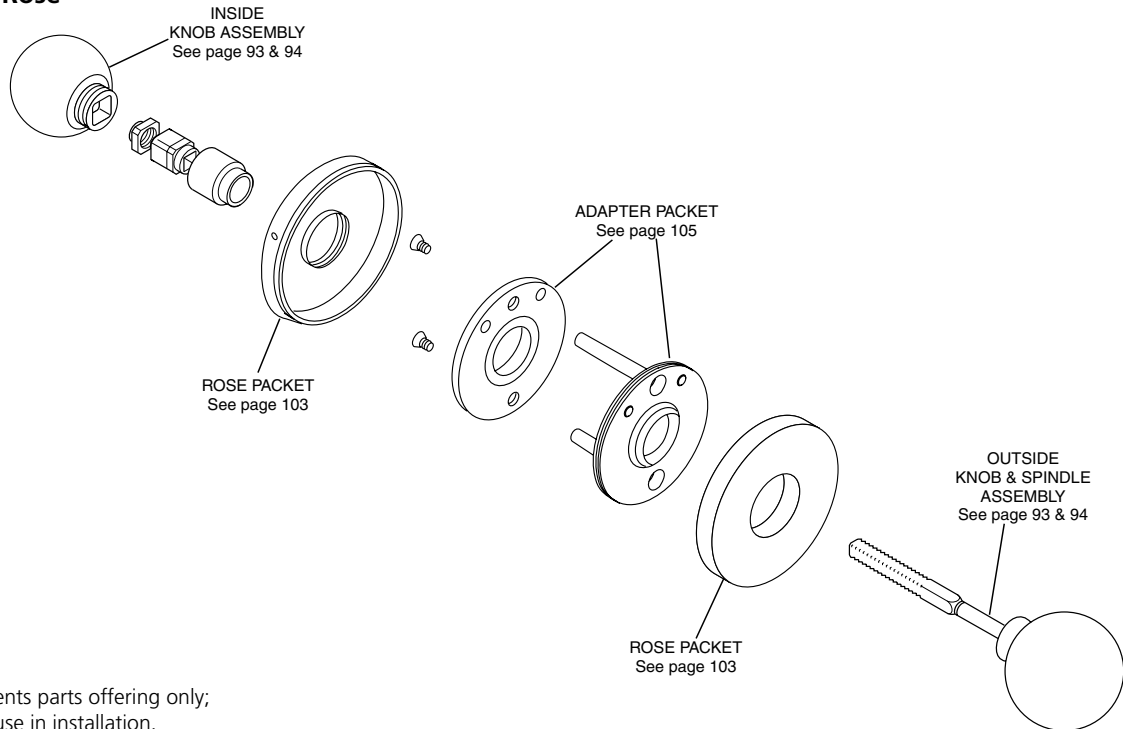

Illustration represents parts offering only; not intended for use in installation.

The warranty on Corbin Russwin products becomes void if the product is modified in any way, regardless of whether the modifications causes or contributes to any alleged defect. If a Corbin Russwin product is modified it may no longer meet industry certification and quality control standards applicable to the original product and is no longer a genuine Corbin Russwin product.

Copyright © 2000-2020, ASSA ABLOY Access and Egress Hardware Group, Inc. All rights reserved. Reproduction in whole or in part without the express written permission of ASSA ABLOY Access and Egress Hardware Group, Inc. is prohibited. Patent pending and/or patent www.assaabloydss.com/patents.



Half Trim - Lever x Escutcheon

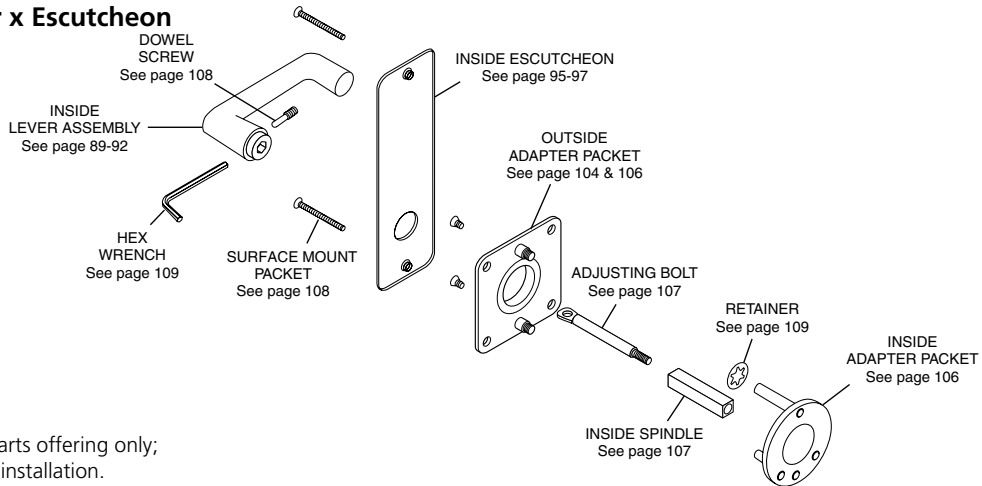

Illustration represents parts offering only; not intended for use in installation.

Half Trim - Wrought Knob x Escutcheon

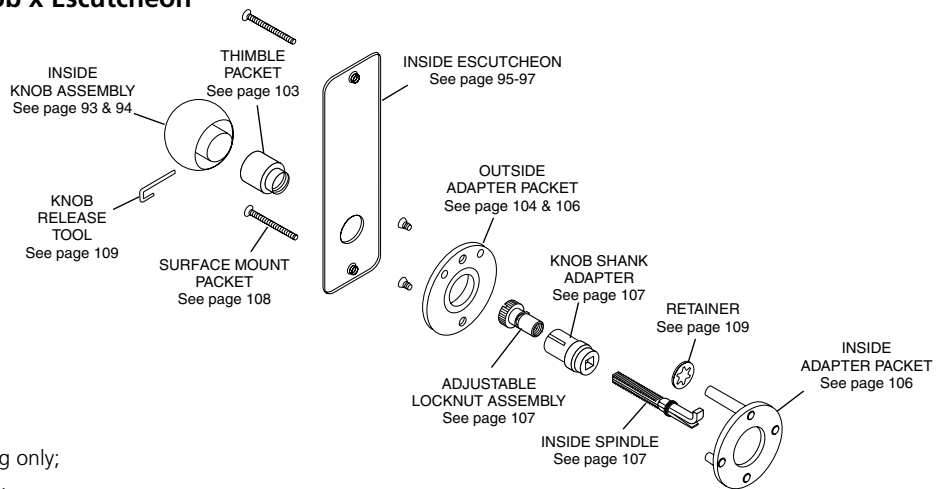

Illustration represents parts offering only; not intended for use in installation.

Half Trim - Cast Knob x Escutcheon

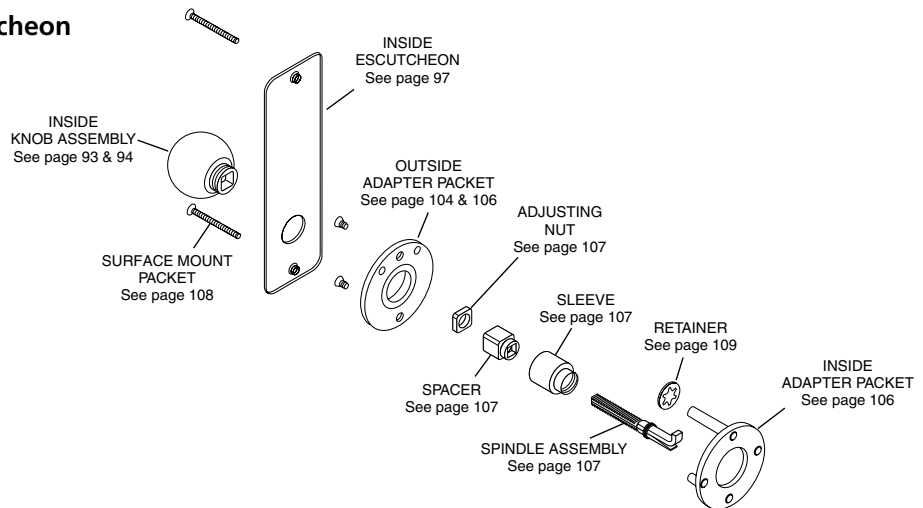

Illustration represents parts offering only; not intended for use in installation.

The warranty on Corbin Russwin products becomes void if the product is modified in any way, regardless of whether the modifications causes or contributes to any alleged defect. If a Corbin Russwin product is modified it may no longer meet industry certification and quality control standards applicable to the original product and is no longer a genuine Corbin Russwin product.

Copyright © 2000-2020, ASSA ABLOY Access and Egress Hardware Group, Inc. All rights reserved. Reproduction in whole or in part without the express written permission of ASSA ABLOY Access and Egress Hardware Group, Inc. is prohibited. Patent pending and/or patent www.assaabloydss.com/patents.

Half Trim - Lever x Rose

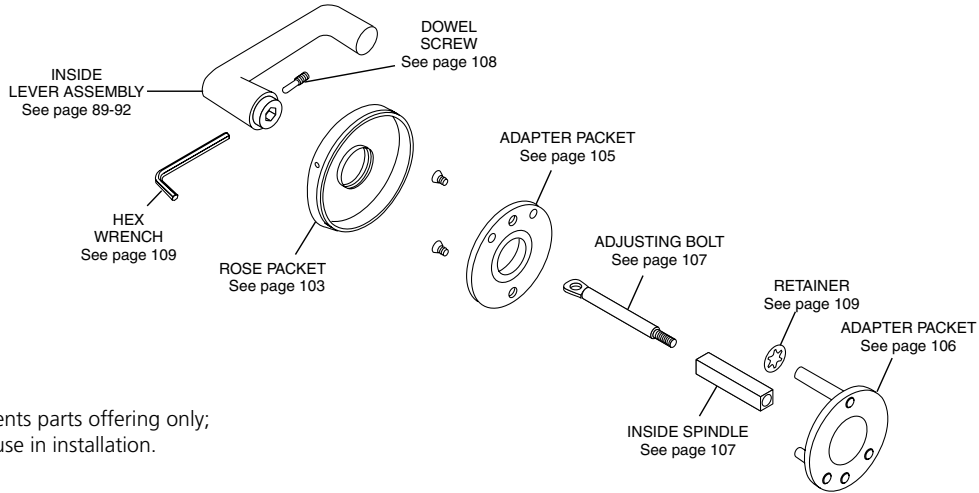

Illustration represents parts offering only; not intended for use in installation.

Half Trim - Wrought Knob x Rose

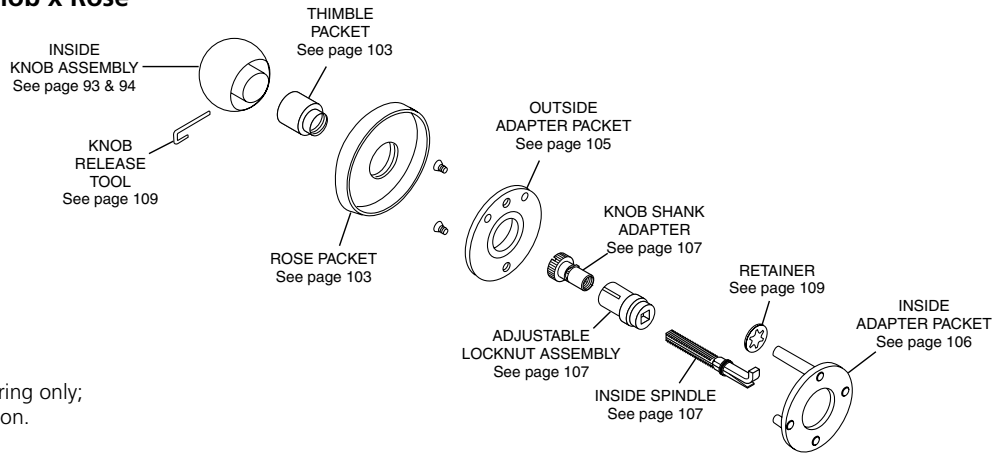

Illustration represents parts offering only; not intended for use in installation.

Half Trim - Cast Knob x Rose

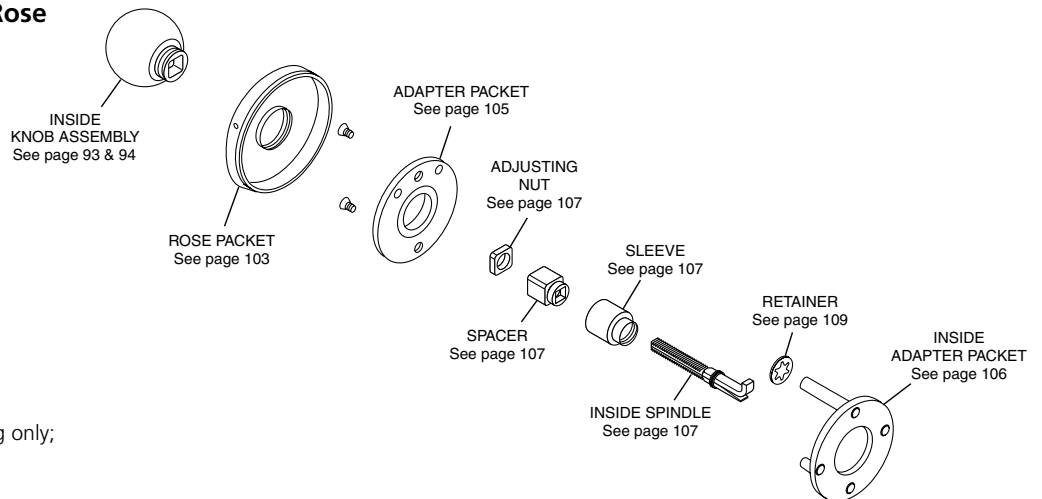

Illustration represents parts offering only; not intended for use in installation.

The warranty on Corbin Russwin products becomes void if the product is modified in any way, regardless of whether the modifications causes or contributes to any alleged defect. If a Corbin Russwin product is modified it may no longer meet industry certification and quality control standards applicable to the original product and is no longer a genuine Corbin Russwin product.

Copyright © 2000-2020, ASSA ABLOY Access and Egress Hardware Group, Inc. All rights reserved. Reproduction in whole or in part without the express written permission of ASSA ABLOY Access and Egress Hardware Group, Inc. is prohibited. Patent pending and/or patent www.assaabloydss.com/patents.



Inside

(Note: All inside levers come complete with dowel screws 483F30)

Outside

AS - Armstrong (Cast)

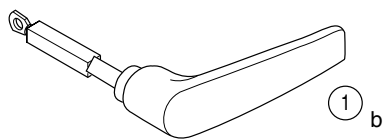
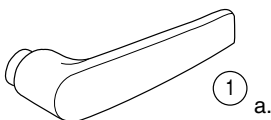

CS - Citation (Cast)

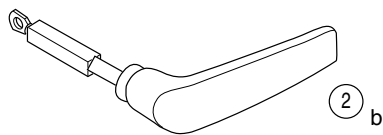
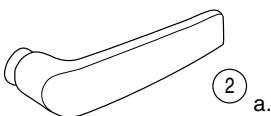

DS - Dirke (Cast)
Specify Hand

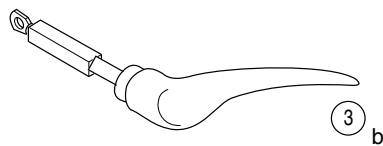

ES - Essex (Cast)

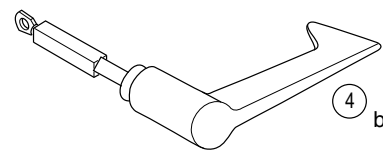
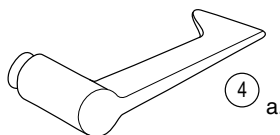

LS - Lustra (Cast)
LW - Lustra (Wrought)

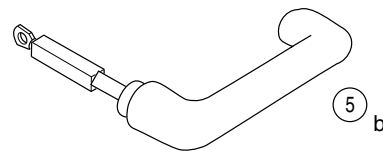
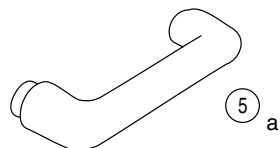

NS - Newport (Cast)

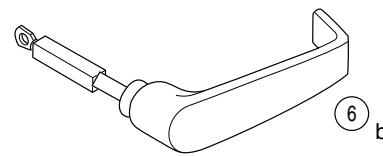
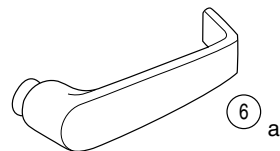

PS - Princeton (Cast)

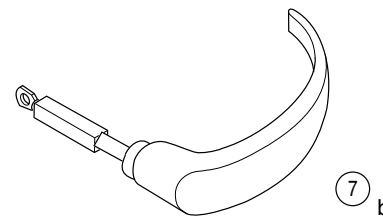
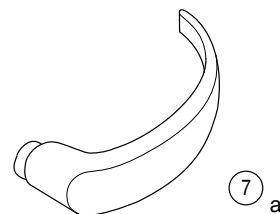

S - Regis (Cast)
RW - Regis (Wrought)

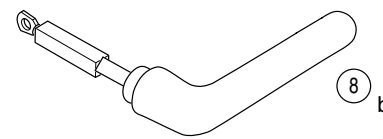
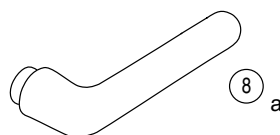

The warranty on Corbin Russwin products becomes void if the product is modified in any way, regardless of whether the modifications causes or contributes to any alleged defect. If a Corbin Russwin product is modified it may no longer meet industry certification and quality control standards applicable to the original product and is no longer a genuine Corbin Russwin product.

Copyright © 2000-2020, ASSA ABLOY Access and Egress Hardware Group, Inc. All rights reserved. Reproduction in whole or in part without the express written permission of ASSA ABLOY Access and Egress Hardware Group, Inc. is prohibited. Patent pending and/or patent www.assaabloydss.com/patents.

Inside Levers & Outside Lever & Spindle Assemblies



ML2000 Parts Manual

Item	Part No.	Description
1		AS - Armstrong (Cast)
A	670F37	Inside Lever
B		Outside Lever & Spindle Assembly
	670F64	for 1-3/8" Door
	670F73	for 1-3/4" Door
	671F09	for 2-1/4" Door
2		CS - Citation (Cast)
A	670F30	Inside Lever
B		Outside Lever & Spindle Assembly
	670F57	for 1-3/8" Door
	670F66	for 1-3/4" Door
	670F02	for 2-1/4" Door
3		DS - Dirke (Cast)
A		Inside Lever for
	670F32	LH/LHR
	670F31	RH/RHR
B		Outside Lever & Spindle Assembly
	670F59	for 1-3/8" Door - RH/RHR
	670F58	for 1-3/8" Door - LH/LHR
	670F68	for 1-3/4" Door - RH/RHR
	670F67	for 1-3/4" Door - LH/LHR
	671F04	for 2-1/4" Door - RH/RHR
	671F03	for 2-1/4" Door - LH/LHR
4		ES - Essex (Cast)
A	670F33	Inside Lever
B		Outside Lever & Spindle Assembly
	670F60	for 1-3/8" Door
	670F69	for 1-3/4" Door
	671F05	for 2-1/4" Door

Item	Part No.	Description
5		LS - Lustra (Cast)
A	670F34	Inside Lever
		LW - Lustra (Wrought)
	493F31	Inside Lever
		LS - Lustra (Cast)
B		Outside Lever & Spindle Assembly
	670F61	for 1-3/8" Door
	670F70	for 1-3/4" Door
	671F06	for 2-1/4" Door
		LW - Lustra (Wrought)
		Outside Lever & Spindle Assembly
	483F79	for 1-3/8" Door
	483F80	for 1-3/4" Door
	483F81	for 2-1/4" Door
6		NS - Newport (Cast)
A	670F36	Inside Lever
B		Outside Lever & Spindle Assembly
	670F63	for 1-3/8" Door
	670F72	for 1-3/4" Door
	671F08	for 2-1/4" Door
7		PS - Princeton (Cast)
A	670F38	Inside Lever
B		Outside Lever & Spindle Assembly
	670F65	for 1-3/8" Door
	670F74	for 1-3/4" Door
	671F10	for 2-1/4" Door
8		RS - Regis (Cast)
A	670F35	Inside Lever
		RW - Regis (Wrought)
	493F34	Inside Lever
		RS - Regis (Cast)
B		Outside Lever & Spindle Assembly
	670F62	for 1-3/8" Door
	670F71	for 1-3/4" Door
	671F07	for 2-1/4" Door
		RW - Regis (Wrought)
		Outside Lever & Spindle Assembly
	483F82	for 1-3/8" Door
	83F83	for 1-3/4" Door
	483F84	for 2-1/4" Door

The warranty on Corbin Russwin products becomes void if the product is modified in any way, regardless of whether the modifications causes or contributes to any alleged defect. If a Corbin Russwin product is modified it may no longer meet industry certification and quality control standards applicable to the original product and is no longer a genuine Corbin Russwin product.

Copyright © 2000-2020, ASSA ABLOY Access and Egress Hardware Group, Inc. All rights reserved. Reproduction in whole or in part without the express written permission of ASSA ABLOY Access and Egress Hardware Group, Inc. is prohibited. Patent pending and/or patent www.assaabloydss.com/patents.



Inside

(Note: All inside levers come complete with dowel screws 483F30)

Outside

F - Frascati (Cast)

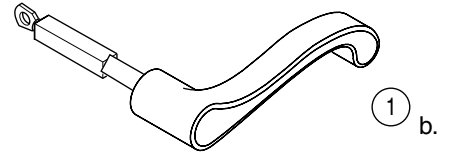
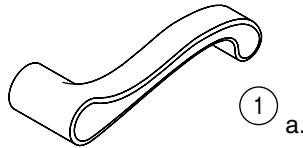

M - Merlot (Cast)

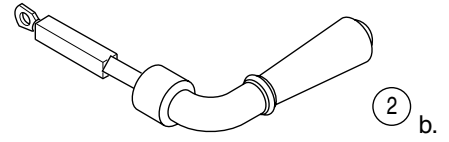
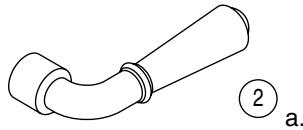

T - Tuscany (Cast)

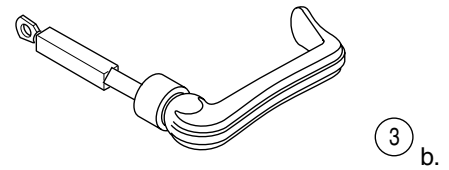
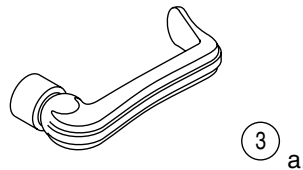

Z - Zinfandel (Cast)

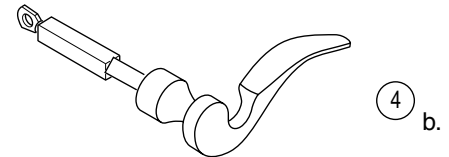
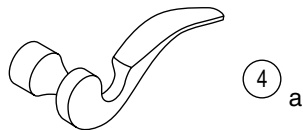

NS - Newport (Cast stainless steel) (Vandal Resistant)

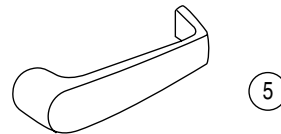

CS - Citation (Cast stainless steel) (Vandal Resistant)

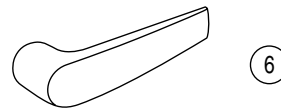

The warranty on Corbin Russwin products becomes void if the product is modified in any way, regardless of whether the modifications causes or contributes to any alleged defect. If a Corbin Russwin product is modified it may no longer meet industry certification and quality control standards applicable to the original product and is no longer a genuine Corbin Russwin product.

Copyright © 2000-2020, ASSA ABLOY Access and Egress Hardware Group, Inc. All rights reserved. Reproduction in whole or in part without the express written permission of ASSA ABLOY Access and Egress Hardware Group, Inc. is prohibited. Patent pending and/or patent www.assaabloydss.com/patents.



(Specify Finish)

Item	Part No.	Description
1		FS - Frascati (Cast)
A	692F63	Inside Lever for LH/LHR Door
	692F64	RH/RHR Door
B	692F75	Outside Lever & Spindle Assembly for 1-3/4" Door - RH/RHR Door
	692F76	for 1-3/4" Door - LH/LHR Door
2		MS - Merlot (Cast)
A	692F65	Inside Lever
B	692F93	Outside Lever & Spindle Assembly for 1-3/4" Door
3		TS - Tuscany (Cast)
A	692F68	Inside Lever
B	692F96	Outside Lever & Spindle Assembly for 1-3/4" Door
4		ZS - Zinfandel (Cast)
A	692F66	Inside Lever for LH/LHR Door
	692F67	RH/RHR Door
B	692F94	Outside Lever & Spindle Assembly for 1-3/4" Door - RH/RHR Door
	92F95	for 1-3/4" Door - LH/LHR Door
5	700F55	NS - Newport Vandal Resistant (Cast Stainless Steel) Inside & Outside Lever for 1 3/4 - 2 1/4" Door
6	700F59	CS - Citation Vandal Resistant (Cast Stainless Steel) Inside & Outside Lever for 1 3/4 - 2 1/4" Door

The warranty on Corbin Russwin products becomes void if the product is modified in any way, regardless of whether the modifications causes or contributes to any alleged defect. If a Corbin Russwin product is modified it may no longer meet industry certification and quality control standards applicable to the original product and is no longer a genuine Corbin Russwin product.

Copyright © 2000-2020, ASSA ABLOY Access and Egress Hardware Group, Inc. All rights reserved. Reproduction in whole or in part without the express written permission of ASSA ABLOY Access and Egress Hardware Group, Inc. is prohibited. Patent pending and/or patent www.assaabloydss.com/patents.

Inside

Outside

BR - Belmont (Wrought)
BW - Belmont (Wrought)

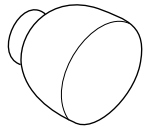

1A

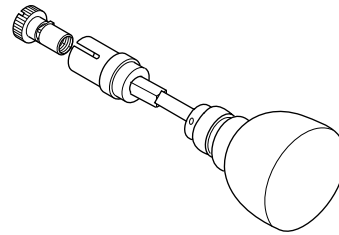

1B

GR - Global (Wrought)
GW - Global (Wrought)

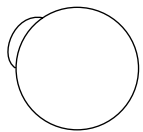

2A

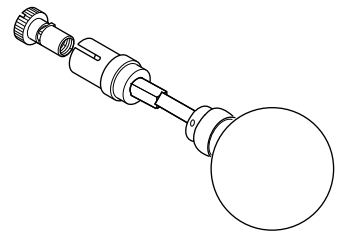

2B

GS - Global (Cast)

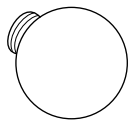

3A

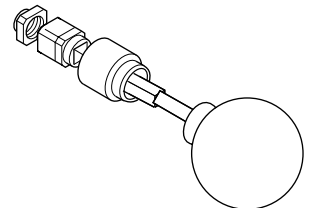

3B

SS - Surety (Cast)

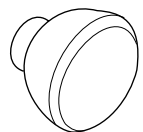

4A

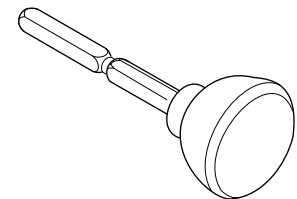

4B

YW - Yankee (Cold Forged)

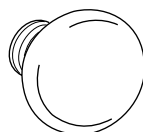

5A

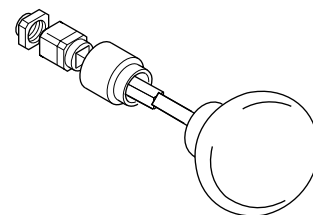

5B

The warranty on Corbin Russwin products becomes void if the product is modified in any way, regardless of whether the modifications causes or contributes to any alleged defect. If a Corbin Russwin product is modified it may no longer meet industry certification and quality control standards applicable to the original product and is no longer a genuine Corbin Russwin product.

Copyright © 2000-2020, ASSA ABLOY Access and Egress Hardware Group, Inc. All rights reserved. Reproduction in whole or in part without the express written permission of ASSA ABLOY Access and Egress Hardware Group, Inc. is prohibited. Patent pending and/or patent www.assaabloydss.com/patents.

(Specify Finish)

Item	Part No.	Description
1		BR - Belmont (Wrought Reinforced)
A	502F29	Inside Lever
		BW - Belmont (Wrought)
	568F12	Inside Knob
		BR - Belmont (Wrought Reinforced)
B		Outside Knob & Spindle Assembly
	689F59	for 1-3/8" Door
	689F61	for 1-3/4" Door
	689F63	for 2-1/4" Door
		BW - Belmont (Wrought)
		Outside Knob & Spindle Assembly
	689F59	for 1-3/8" Door
	689F61	for 1-3/4" Door
	689F63	for 2-1/4" Door
2		GR - Global (Wrought Reinforced)
A	502F27	Inside Knob
B		GW - Global (Wrought)
	568F11	Inside Knob
		GR - Global (Wrought Reinforced)
B		Outside Knob & Spindle Assembly
	689F50	for 1-3/8" Door
	689F52	for 1-3/4" Door
	689F54	for 2-1/4" Door
		GW - Global (Wrought)
		Outside Knob & Spindle Assembly
	689F58	for 1-3/8" Door
	689F60	for 1-3/4" Door
	689F62	for 2-1/4" Door

(Specify Finish)

Item	Part No.	Description
3		GS - Global (Cast)
A	503F15	Inside Lever
B		Outside Knob & Spindle Assembly
	689F28	for 1-3/8" Door
	689F31	for 1-3/4" Door
	689F37	for 2-1/4" Door
4		SS - Surety (Cast)
A	445F38	Inside Knob
B		Outside Knob & Spindle Assembly
	445F43	for 1-3/8" Door
	498F86	for 1-3/4" Door
	498F87	for 2-1/4" Door
5		YW - Yankee (Cast Forged)
A	502F62	Inside Knob
B		Outside Knob & Spindle Assembly
	689F30	for 1-3/8" Door
	689F33	for 1-3/4" Door
	689F39	for 2-1/4" Door

The warranty on Corbin Russwin products becomes void if the product is modified in any way, regardless of whether the modifications causes or contributes to any alleged defect. If a Corbin Russwin product is modified it may no longer meet industry certification and quality control standards applicable to the original product and is no longer a genuine Corbin Russwin product.

Copyright © 2000-2020, ASSA ABLOY Access and Egress Hardware Group, Inc. All rights reserved. Reproduction in whole or in part without the express written permission of ASSA ABLOY Access and Egress Hardware Group, Inc. is prohibited. Patent pending and/or patent www.assaabloydss.com/patents.

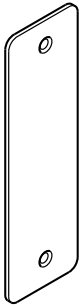

1
Inside
Blank

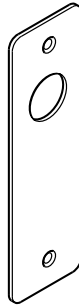

2
Inside For Cyl-
inder Only



3
Inside For Grip
Only



4
Inside For
Cylinder & Grip

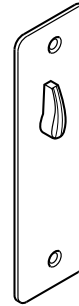

5
Inside For
Thumbturn Lever
Only

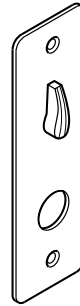

6
Inside For
Thumbturn Lever
& Grip



7
Outside
Blank



8
Outside
For Cylinder Only



9
Outside
For Grip Only



10
Outside
For Cylinder
& Grip



11
Outside
For Grip &
Emergency Key

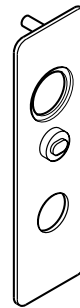

12
Outside For Cyl-
inder, Grip
& Indicator

7-1/2" x 2-1/4" Wrought (Specify Finish)

Item	Part No.	Description
1	545F45	Inside - Blank
2	545F00	Inside - for Cylinder Only Conventional
	751F16	Master Ring
3	544F95	Inside - for Grip Only
4	544F96	Inside - for Cylinder and Grip Conventional
	377F80	Master Ring
5	545F42	Inside - for Thumbturn Lever Only for 1-3/8" Door
	545F43	for 1-3/4" Door
	545F44	for 2-1/4" Door
6	544F97	Inside - for Thumbturn Lever & Grip for 1-3/8" Door
	544F98	for 1-3/4" Door
	544F99	for 2-1/4" Door

7-1/2" x 2-1/4" Wrought (Specify Finish)

Item	Part No.	Description
7	383F82	Outside - Blank
8	488F07	Outside - for Cylinders Only Conventional
	751F16	Master Ring
9	488F04	Outside - for Grip Only
10	488F05	Outside - for Cylinder and Grip Conventional
	557F29	Master Ring
11	544F94	Outside - for Grip & Emergency Key
12	433F48	Outside - for Cylinder, Grip & Indicator for 1-3/8" Door
	433F49	for 1-3/4" Door
	484F90	for 2-1/4" Door

The warranty on Corbin Russwin products becomes void if the product is modified in any way, regardless of whether the modifications causes or contributes to any alleged defect. If a Corbin Russwin product is modified it may no longer meet industry certification and quality control standards applicable to the original product and is no longer a genuine Corbin Russwin product.

Copyright © 2000-2020, ASSA ABLOY Access and Egress Hardware Group, Inc. All rights reserved. Reproduction in whole or in part without the express written permission of ASSA ABLOY Access and Egress Hardware Group, Inc. is prohibited. Patent pending and/or patent www.assaabloydss.com/patents.

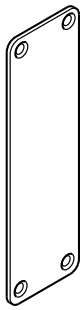

1
Inside
Blank

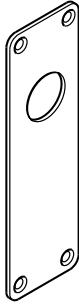

2
Inside or
Outside For Cylinder Only

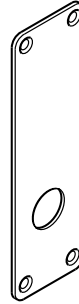

3
Inside or
Outside
For Grip Only



4
Inside or
Outside For Cylinder & Grip

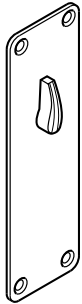

5
Inside For
Thumbturn
Lever Only

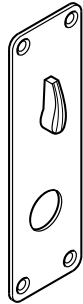

6
Inside For
Thumbturn
Lever & Grip



7
Outside
For Grip &
Emergency Key

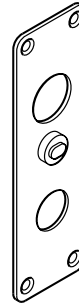

8
Outside For Cylin-
der, Grip
& Indicator

7-1/2" x 2-1/4" Wrought (Specify Finish)

Item	Part No.	Description
1	544F93	Inside or Outside - Blank
2	544F80	Inside or Outside - for Cylinder Only
3	544F76	Inside or Outside - for Grip Only
4	544F77	Inside or Outside - for Cylinder and Grip
5		Inside - for Thumbturn Lever Only
	544F92	for 1-3/8" Door
	544F89	for 1-3/4" Door
	544F91	for 2-1/4" Door

7-1/2" x 2-1/4" Wrought (Specify Finish)

Item	Part No.	Description
6		Inside - for Thumbturn Lever & Grip
	544F88	for 1-3/8" Door
	544F85	for 1-3/4" Door
	544F87	for 2-1/4" Door
7	544F79	Outside - for Trim & Emergency Key
8		Outside - for Cylinder, Grip & Indicator
	544F82	for 1-3/8" Door
	544F83	for 1-3/4" Door
	544F84	for 2-1/4" Door

The warranty on Corbin Russwin products becomes void if the product is modified in any way, regardless of whether the modifications causes or contributes to any alleged defect. If a Corbin Russwin product is modified it may no longer meet industry certification and quality control standards applicable to the original product and is no longer a genuine Corbin Russwin product.

Copyright © 2000-2020, ASSA ABLOY Access and Egress Hardware Group, Inc. All rights reserved. Reproduction in whole or in part without the express written permission of ASSA ABLOY Access and Egress Hardware Group, Inc. is prohibited. Patent pending and/or patent www.assaabloydss.com/patents.

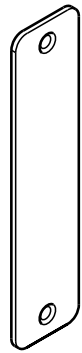

1
Inside
Blank

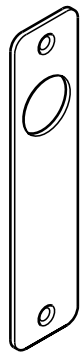

2
Inside
For Cylinder Only



3
Inside
For Grip Only

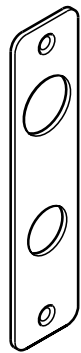

4
Inside
For Cylinder
& Grip

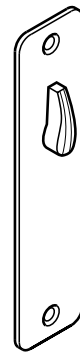

5
Inside For
Thumbturn Lever
Only

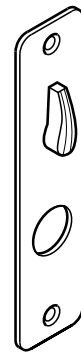

6
Inside For
Thumbturn Lever
& Grip



7
Outside
Blank

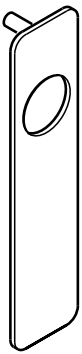

8
Outside
For Cylinder Only



9
Outside
For Grip Only

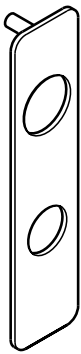

10
Outside
For Cylinder
& Grip



11
Outside
For Grip &
Emergency Key



12
Outside
For Cylinder, Grip &
Indicator

7" x 1-5/8" Wrought (Specify Finish)

Item	Part No.	Description
1	544F46	Inside - Blank
2	544F43	Inside - for Cylinder Only
3	544F39	Inside - for Grip Only
4	544F40	Inside - for Cylinder and Grip
5	544F14	Inside - for Thumbturn Lever Only for 1-3/8" Door
	544F45	for 1-3/4" Door
	544F44	for 2-1/4" Door
6	544F13	Inside - for Thumbturn Lever & Grip for 1-3/8" Door
	544F42	for 1-3/4" Door
	544F41	for 2-1/4" Door

7" x 1-5/8" Wrought (Specify Finish)

Item	Part No.	Description
7	384F11	Outside - Blank
8	488F03	Outside - for Cylinder Only
9	488F00	Outside - for Grip Only
10	488F01	Outside - for Cylinder & Grip
11	544F38	Outside - for Grip & Emergency Key
12	430F47	Outside - for Cylinder, Grip & Indicator for 1-3/8" Door
	435F00	for 1-3/4" Door
	484F76	for 2-1/4" Door

The warranty on Corbin Russwin products becomes void if the product is modified in any way, regardless of whether the modifications causes or contributes to any alleged defect. If a Corbin Russwin product is modified it may no longer meet industry certification and quality control standards applicable to the original product and is no longer a genuine Corbin Russwin product.

Copyright © 2000-2020, ASSA ABLOY Access and Egress Hardware Group, Inc. All rights reserved. Reproduction in whole or in part without the express written permission of ASSA ABLOY Access and Egress Hardware Group, Inc. is prohibited. Patent pending and/or patent www.assaabloydss.com/patents.

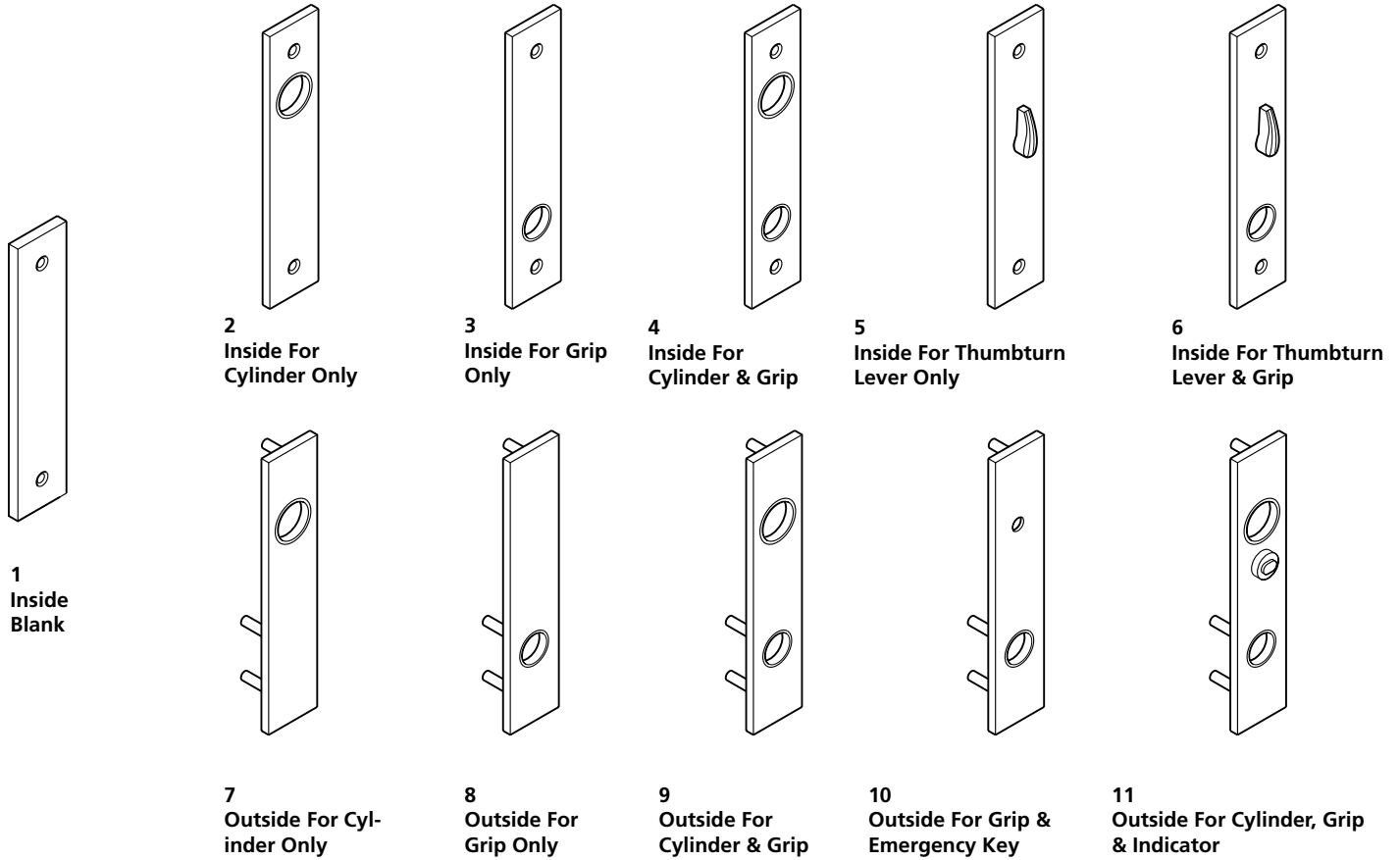

8-1/2" x 1-3/4" Cast (Specify Finish)

Item	Part No.	Description
1	545F79	Inside - Blank
2	545F88	Inside - for Cylinder Only
3	545F87	Inside - for Grip Only
4	545F80	Inside - for Cylinder and Grip
5	545F84	Inside - for Thumbturn Lever Only for 1-3/8" Door
	545F85	for 1-3/4" Door
	545F86	for 2-1/4" Door
6	545F81	Inside - for Thumbturn Lever & Grip for 1-3/8" Door
	545F82	for 1-3/4" Door
	545F83	for 2-1/4" Door
7	427F44	Outside - for Cylinder Only for 1-3/8" Door
	427F45	for 1-3/4" Door
	485F77	for 2-1/4" Door

8-1/2" x 1-3/4" Cast (Specify Finish)

Item	Part No.	Description
8	427F42	Outside - For Grip Only for 1-3/8" Door
	427F43	for 1-3/4" Door
	485F76	for 2-1/4" Door
9	427F38	Outside - For Cylinder and Grip for 1-3/8" Door
	427F39	for 1-3/4" Door
	485F75	for 2-1/4" Door
10	427F46	Outside - for Grip & Emergency Key for 1-3/8" Door
	427F47	for 1-3/4" Door
	485F78	for 2-1/4" Door
11	427F36	Outside - for Cylinder, Grip & Indicator for 1-3/8" Door
	427F37	for 1-3/4" Door
	485F74	for 2-1/4" Door

The warranty on Corbin Russwin products becomes void if the product is modified in any way, regardless of whether the modifications causes or contributes to any alleged defect. If a Corbin Russwin product is modified it may no longer meet industry certification and quality control standards applicable to the original product and is no longer a genuine Corbin Russwin product.

Copyright © 2000-2020, ASSA ABLOY Access and Egress Hardware Group, Inc. All rights reserved. Reproduction in whole or in part without the express written permission of ASSA ABLOY Access and Egress Hardware Group, Inc. is prohibited. Patent pending and/or patent www.assaabloydss.com/patents.

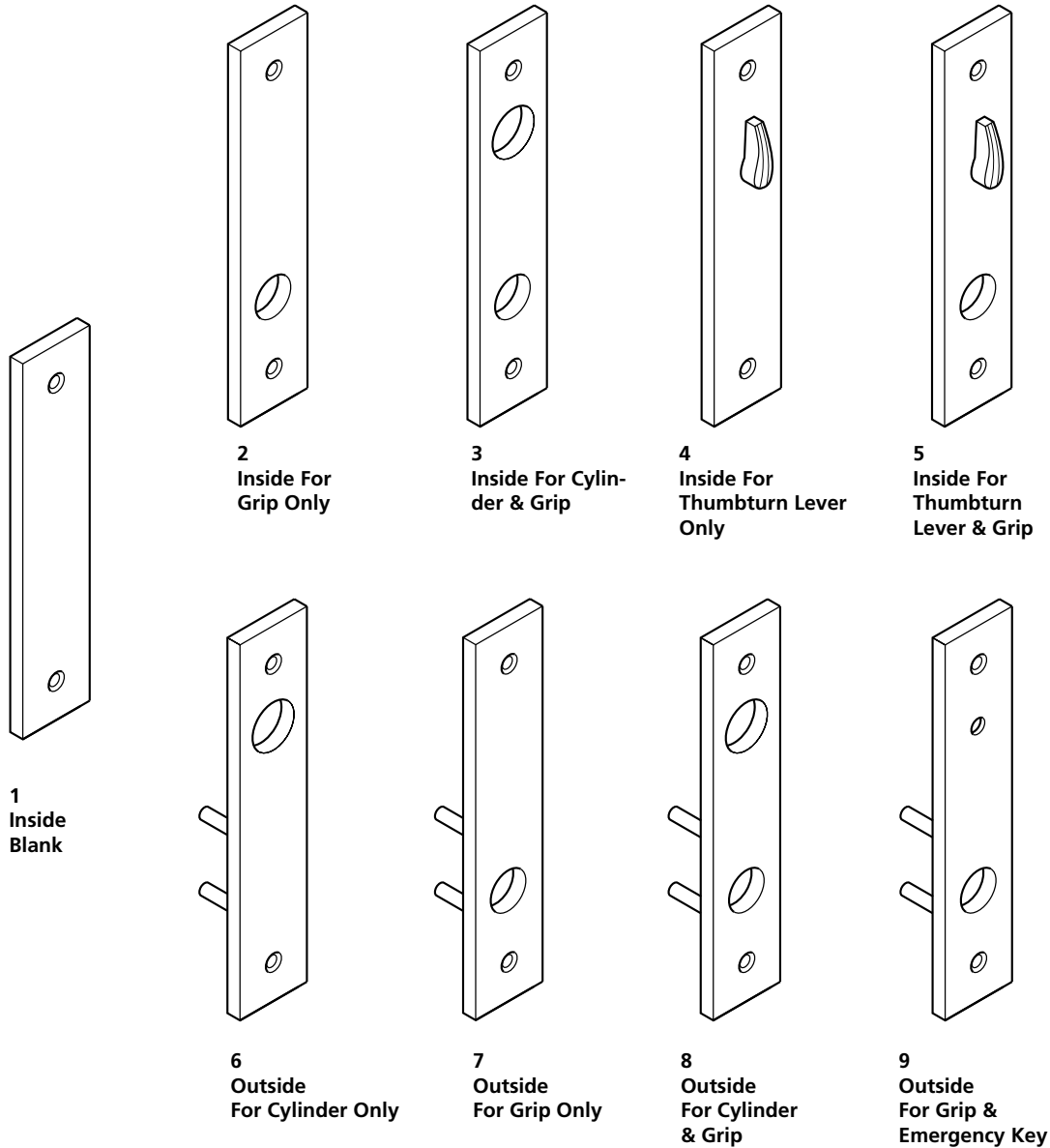

8-1/2" x 1-3/4" Cast (Specify Finish)

Item	Part No.	Description
1	498F80	Inside - Blank
2	445F57	Inside - for Cylinder Only
3	445F33	Inside - for Cylinder and Grip
4	445F35	Inside - for Thumbturn Lever Only
5	445F34	Inside - for Thumbturn Lever & Grip

8-1/2" x 1-3/4" Cast (Specify Finish)

Item	Part No.	Description
6	445F37	Outside - for Cylinder Only
77	445F58	Outside - for Grip Only
8	445F36	Outside - for Cylinder & Grip
9	445F59	Outside - for Grip & Emergency Key

The warranty on Corbin Russwin products becomes void if the product is modified in any way, regardless of whether the modifications causes or contributes to any alleged defect. If a Corbin Russwin product is modified it may no longer meet industry certification and quality control standards applicable to the original product and is no longer a genuine Corbin Russwin product.

Copyright © 2000-2020, ASSA ABLOY Access and Egress Hardware Group, Inc. All rights reserved. Reproduction in whole or in part without the express written permission of ASSA ABLOY Access and Egress Hardware Group, Inc. is prohibited. Patent pending and/or patent www.assaabloydss.com/patents.

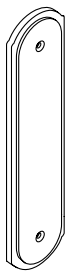

1
Inside
Blank

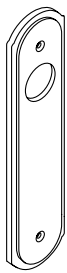

2
Inside For
Cylinder
Only



3
Inside For
Grip Only



4
Inside For
Cylinder &
Grip

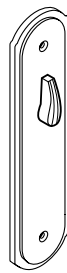

5
Inside For
Thumbturn
Lever Only

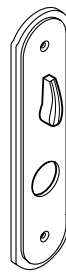

6
Inside For
Thumbturn
Lever & Grip

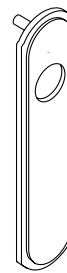

7
For Cylinder
Only

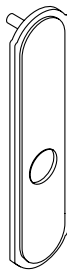

8
Outside For
Grip Only



9
Outside For
Cylinder &
Grip



10
Outside For Grip
& Emergency
Key

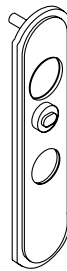

11
Outside For
Cylinder, Grip
& Indicator

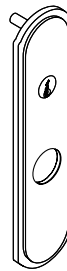

12
Outside
For Grip
& Plug Only

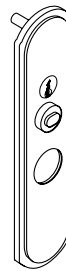

13
Outside For
Grip, Plug &
Indicator Only

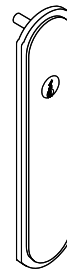

14
Outside For
Plug Only

9-3/16" x 2-3/16" Cast (Specify Finish)

Item	Part No.	Description
1	692F86	Inside - Blank
2	694F32	Inside - for Cylinder Only
3	694F31	Inside - for Grip Only
4	694F33	Inside - for Cylinder and Grip
5	694F34	Inside - for Thumbturn Lever Only for 1-3/8" Door
	694F35	for 1-3/4" Door
	694F36	for 2" Door
	694F37	for 2-1/4" Door
6	694F38	Inside - for Thumbturn Lever & Grip for 1-3/8" Door
	694F39	for 1-3/4" Door
	694F40	for 2" Door
	694F41	for 2-1/4" Door
7	694F51	Outside - for Cylinder Only for 1-3/8" Door
	694F52	for 1-3/4" Door
	694F53	for 2" Door
	694F54	for 2-1/4" Door

9-3/16" x 2-3/16" Cast (Specify Finish)

Item	Part No.	Description
8	694F43	Outside - for Grip Only for 1-3/8" Door
	694F44	for 1-3/4" Door
	694F45	for 2" Door
	694F46	for 2-1/4" Door
9	694F55	Outside - for Cylinder & Grip for 1-3/8" Door
	694F56	for 1-3/4" Door
	694F57	for 2" Door
	694F58	for 2-1/4" Door
10	694F47	Outside - for Grip & Emergency Key for 1-3/8" Door
	694F48	for 1-3/4" Door
	694F49	for 2" Door
	694F50	for 2-1/4" Door

The warranty on Corbin Russwin products becomes void if the product is modified in any way, regardless of whether the modifications causes or contributes to any alleged defect. If a Corbin Russwin product is modified it may no longer meet industry certification and quality control standards applicable to the original product and is no longer a genuine Corbin Russwin product.

Copyright © 2000-2020, ASSA ABLOY Access and Egress Hardware Group, Inc. All rights reserved. Reproduction in whole or in part without the express written permission of ASSA ABLOY Access and Egress Hardware Group, Inc. is prohibited. Patent pending and/or patent www.assaabloydss.com/patents.

9-3/16" x 2-3/16" Cast (Specify Finish)

Item	Part No.	Description
11	694F59	Outside - for Cylinder, Grip & Indicator for 1-3/8" Door
	694F60	for 1-3/4" Door
	694F61	for 2" Door
	694F62	for 2-1/4" Door
12	694F67	Outside - for Grip & Plug Only for 1-3/8" Door
	694F68	for 1-3/4" Door
	694F69	for 2" Door
	694F70	for 2-1/4" Door
13	694F71	Outside - for Grip, Plug & Indicator Only for 1-3/8" Door
	694F72	for 1-3/4" Door
	694F73	for 2" Door
	694F74	for 2-1/4" Door
14	694F63	Outside - for Plug Only for 1-3/8" Door
	694F64	for 1-3/4" Door
	694F65	for 2" Door
	694F66	for 2-1/4" Door

The warranty on Corbin Russwin products becomes void if the product is modified in any way, regardless of whether the modifications causes or contributes to any alleged defect. If a Corbin Russwin product is modified it may no longer meet industry certification and quality control standards applicable to the original product and is no longer a genuine Corbin Russwin product.

Copyright © 2000-2020, ASSA ABLOY Access and Egress Hardware Group, Inc. All rights reserved. Reproduction in whole or in part without the express written permission of ASSA ABLOY Access and Egress Hardware Group, Inc. is prohibited. Patent pending and/or patent www.assaabloydss.com/patents.

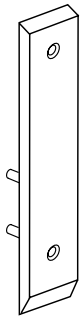

1
Inside
Blank

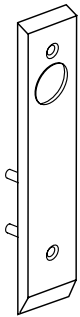

2
Inside For
Cylinder Only

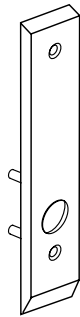

3
Inside For Grip
Only

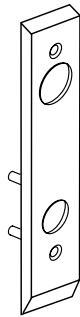

4
Inside For
Cylinder &
Grip

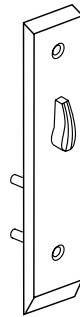

5
Inside For
Thumbturn
Lever Only

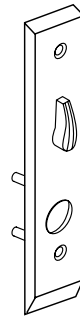

6
Inside For
Thumbturn
Lever & Grip

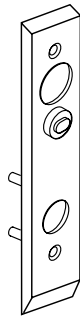

7
Inside For
Cylinder, Grip &
Indicator

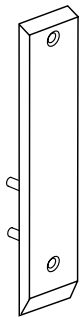

8
Outside
Blank

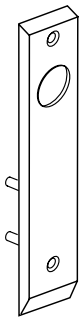

9
Outside For
Cylinder Only



10
Outside For
Grip Only

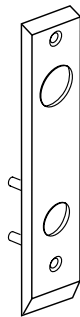

11
Outside For
Cylinder & Grip

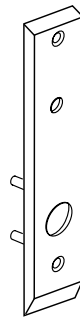

12
Outside For
Grip &
Emergency Key

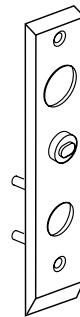

13
Outside
For Cylinder, Grip
& Indicator

8-1/2" x 2-1/8" Cast

Item	Part No.	Description
1	700F40	Inside - Blank
2	700F43 700F48*	Inside - for Cylinder Only (not shown) (7P & C6)
3	700F41	Inside - for Grip Only
4	700F42 700F47*	Inside - for Cylinder and Grip (not shown) (7P & C6)
5	700F45	Inside - for Thumbturn Lever Only
6	700F44	Inside - for Thumbturn Lever & Grip
7	700F46	Inside - for Cylinder, Grip & Indicator
8	700F80	Outside Blank

8-1/2" x 2-1/8" Cast

Item	Part No.	Description
9	700F83 700F88*	Outside - for Cylinder Only (not shown) (7P & C6)
10	700F81	Outside - for Grip Only
11	700F82 700F87*	Outside - for Cylinder and Grip (not shown) (7P & C6)
12	700F84	Outside - for Grip & Emergency Key
13	700F86	Outside - for Cylinder, Grip & Indicator

* Use these escutcheons when collar is required.

The warranty on Corbin Russwin products becomes void if the product is modified in any way, regardless of whether the modifications causes or contributes to any alleged defect. If a Corbin Russwin product is modified it may no longer meet industry certification and quality control standards applicable to the original product and is no longer a genuine Corbin Russwin product.

Copyright © 2000-2020, ASSA ABLOY Access and Egress Hardware Group, Inc. All rights reserved. Reproduction in whole or in part without the express written permission of ASSA ABLOY Access and Egress Hardware Group, Inc. is prohibited. Patent pending and/or patent www.assaabloydss.com/patents.

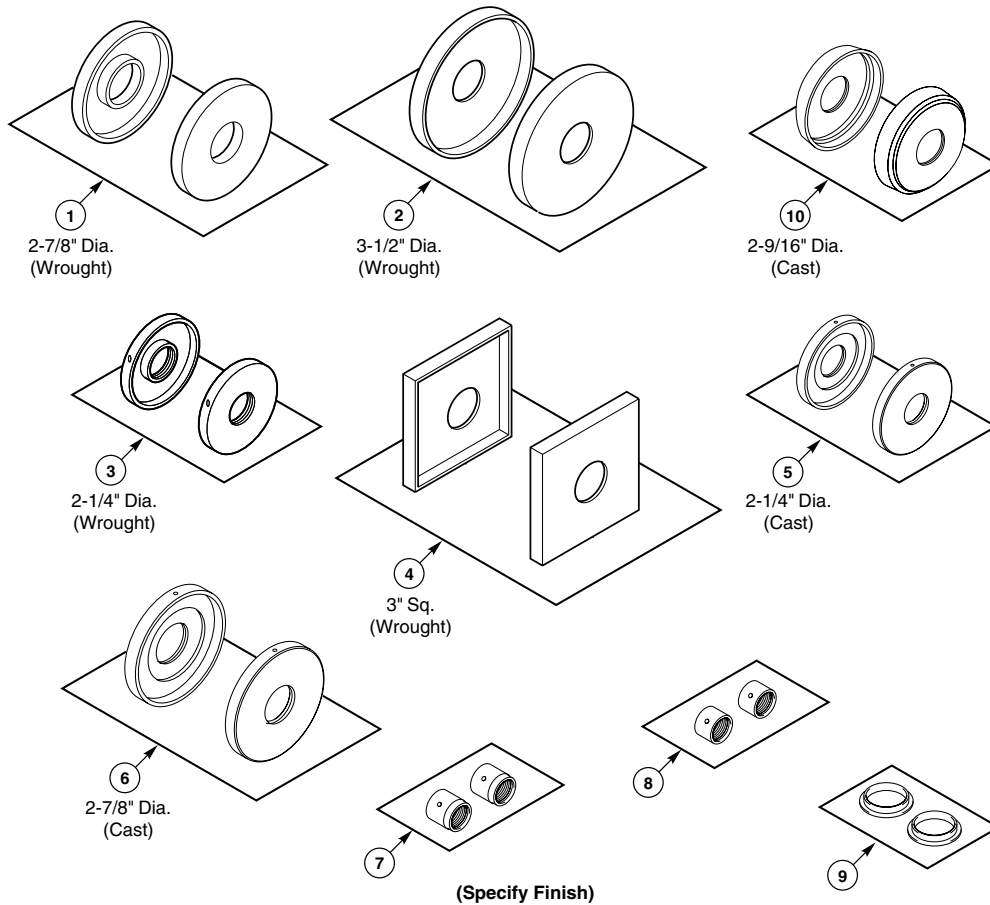

(Specify Finish)

Item	Part No.	Description
1	445F82	Wrought Rose Packet, containing: (Qty. 2) 2-7/8" Dia. Roses (C Roses)
2	445F83	Wrought Rose Packet, containing: (Qty. 2) 3-1/2" Dia. Roses (D Roses)
3	487F08	Wrought Rose Packet, containing: (Qty. 2) 2-1/4" Dia. Roses (A Roses)
4	445F84	Wrought Rose Packet, containing: (Qty. 2) 3" Dia. Roses (E Roses)
5	447F25	Cast Rose Packet, containing: (Qty. 2) 2-1/4" Dia. Roses (B Roses)
6	447F24	Cast Rose Packet, containing: (Qty. 2) 2-7/8" Dia. Roses (F Roses)

(Specify Finish)

Item	Part No.	Description
7	445F85	Thimble Packet, containing: (Qty. 2) Thimbles for Sectional Wrought Knob Trim Designs
8	432F86	Thimble Packet, containing: (Qty. 2) Thimbles for Wrought Knob by Escutcheon Trim Designs
9	445F86 (No Finish)	Rose Reinforcement Packet, containing: (Qty. 2) Rose Reinforcements
10	694F80	Cast Rose Packet, containing: (Qty. 2) 2-9/16" Dia. Vineyard Collection Roses (G Roses)

The warranty on Corbin Russwin products becomes void if the product is modified in any way, regardless of whether the modifications causes or contributes to any alleged defect. If a Corbin Russwin product is modified it may no longer meet industry certification and quality control standards applicable to the original product and is no longer a genuine Corbin Russwin product.

Copyright © 2000-2020, ASSA ABLOY Access and Egress Hardware Group, Inc. All rights reserved. Reproduction in whole or in part without the express written permission of ASSA ABLOY Access and Egress Hardware Group, Inc. is prohibited. Patent pending and/or patent www.assaabloydss.com/patents.

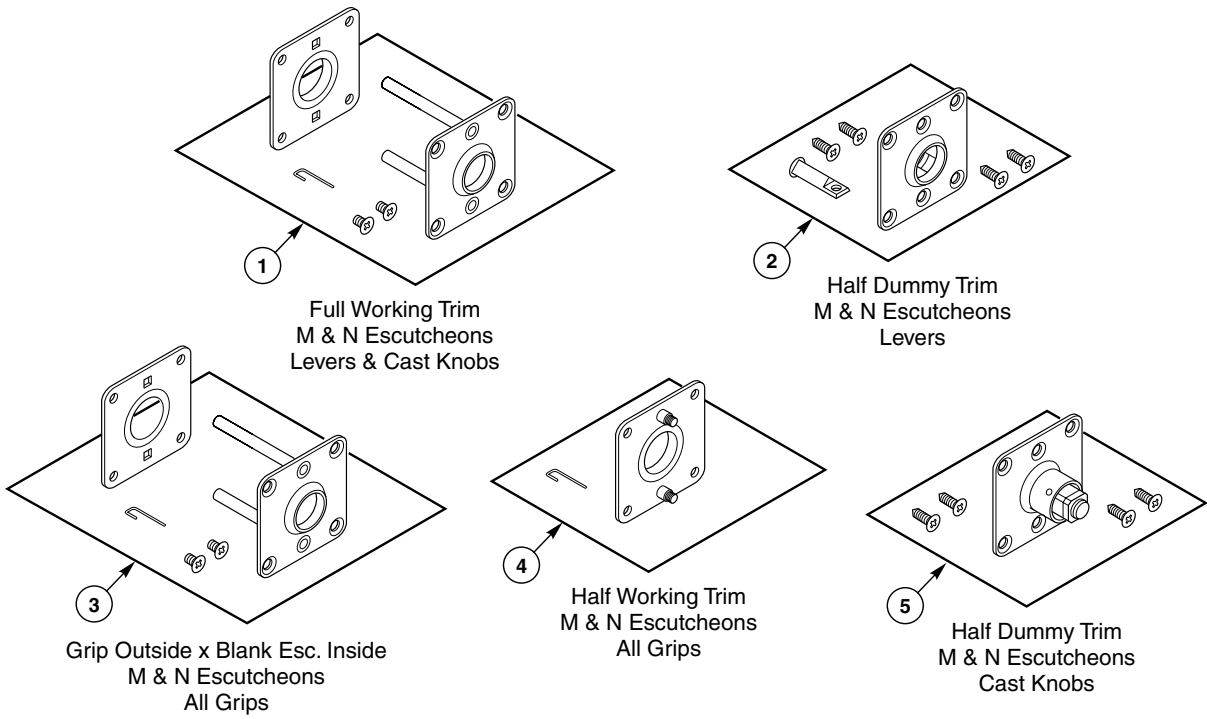

NOTE: Each adapter packet comes with appropriate size adapter plates & screws for door thickness as ordered.

Item	Part No.	Description	Item	Part No.	Description
1	466F50	Adapter Packet - Full Working Trim, containing: 1 - Inside Adapter Plate 1 - Outside Adapter Plate 2 - #8-32 Phillips Flat Hd Scre 1 - Knob Release Tool for 1-3/8" Door	4	428F32	Adapter Packet - Half Working Trim, containing: 1 - Adapter Plate 2 - #8-32 Phillips Flat Hd Machine Screws 1 - Knob Release Tool for 1-3/8" Door
	466F51	for 1-3/4" Door		428F33	for 1-3/4" Door
	466F52	for 2-1/4" Door		428F34	for 2-1/4" Door
2	488F32	Adapter Packet - Lever Half Dummy Trim, containing: 1 - Adapter Plate 1 - Spindle 4 - #8 Phillips Flat Head Combination Screws	5	438F37	Adapter Packet - Cast Knob Half Dummy Trim, containing: 1 - Adapter Plate 4 - #8 Phillips Flat Hd Combination Screws 1 - Adjusting Nut 1 - Spindle Sub Assembly 1 - Sleeve 1 - Spacer
3		Adapter Packet - Grip Outside x Blank Escutcheon Inside, containing: 1 - Inside Adapter Plate 1 - Outside Adapter Plate 2 - #8-32 Phillips Flat Hd Undercut Machine Screws 1 - Knob Release Tool			
	466F45	for 1-3/8" Door			
	466F46	for 1-3/4" Door			
	466F47	for 2-1/4" Door			

The warranty on Corbin Russwin products becomes void if the product is modified in any way, regardless of whether the modifications causes or contributes to any alleged defect. If a Corbin Russwin product is modified it may no longer meet industry certification and quality control standards applicable to the original product and is no longer a genuine Corbin Russwin product.

Copyright © 2000-2020, ASSA ABLOY Access and Egress Hardware Group, Inc. All rights reserved. Reproduction in whole or in part without the express written permission of ASSA ABLOY Access and Egress Hardware Group, Inc. is prohibited. Patent pending and/or patent www.assaabloydss.com/patents.

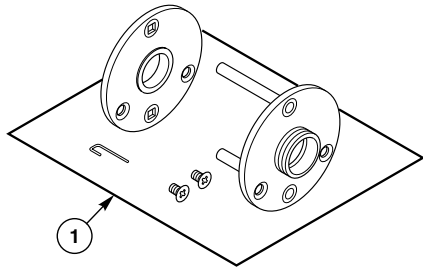

1
Full Working Trim Sectional
(Also for M & N Escutcheons with
Wrought Knobs)

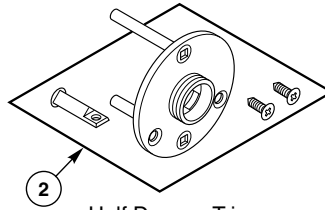

2
Half Dummy Trim
Sectional
Levers

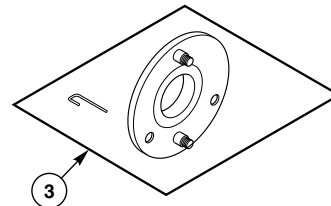

3
Half Working Trim
Sectional
Levers

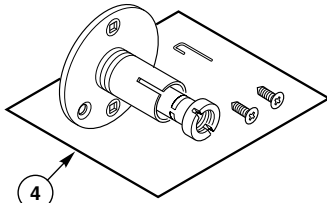

4
Half Dummy Trim*
Sectional & M & N Escutcheons
Wrought Knobs

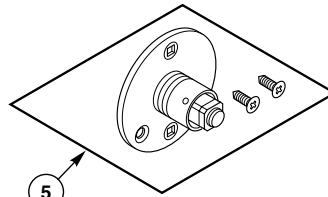

5
Half Dummy Trim
Sectional
Cast Knobs

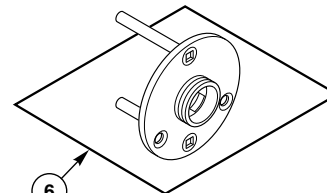

6
Full Dummy Trim
Sectional
Levers

NOTE: Each adapter packet comes with appropriate size adapter plates & screws for door thickness as ordered.

Item	Part No.	Description	Item	Part No.	Description
1	466F40 466F41 466F42	Adapter Packet - Full Working Trim, containing: 1 - Inside Adapter Plate 1 - Outside Adapter Plate 2 - #8-32 Phillips Flat Hd Undercut Machine Screws 1 - Knob Release Tool for 1-3/8" Door for 1-3/4" Door for 2-1/4" Door	4	511F51	Adapter Packet - Wrought Knob, Half Dummy Trim, containing: 1 - Adapter Plate 2 - #8-32 Phillips Flat Hd Combination Screws 1 - Knob Release Tool 1 - Knob Catch Assembly 1 - Adj. Locknut Assembly 1 - Spindle Sub Assembly 1 - Knob Shank Adapter
2	488F30	Adapter Packet - Lever Half Dummy Sectional Trim, containing: 1 - Adapter Plate 1 - Spindle 2 - #8 Phillips Flat Head Combination Screws 2 - #8 Hollow Countersunk Washers	5	438F38	Adapter Packet - Cast Knob Half Dummy Trim, containing: 1 - Adapter Plate 2 - #8 Phillips Flat Hd Combination Screws 1 - Adjusting Nut 1 - Spindle Sub Assembly 1 - Sleeve 1 - Spacer
3	437F40 437F41 437F42	Adapter Packet - Half Working Sectional Trim, containing: 1 - Adapter Plate 2 - #8-32 Phillips Flat Hd Undercut Machine Screws 1 - Knob Release Tool for 1-3/8" Door for 1-3/4" Door for 2-1/4" Door	6	437F16	Adapter Packet - Full Dummy Sectional Lever Trim, containing: 1 - Adapter Plate 1 - Sleeve 1 - Bushing

The warranty on Corbin Russwin products becomes void if the product is modified in any way, regardless of whether the modifications causes or contributes to any alleged defect. If a Corbin Russwin product is modified it may no longer meet industry certification and quality control standards applicable to the original product and is no longer a genuine Corbin Russwin product.

Copyright © 2000-2020, ASSA ABLOY Access and Egress Hardware Group, Inc. All rights reserved. Reproduction in whole or in part without the express written permission of ASSA ABLOY Access and Egress Hardware Group, Inc. is prohibited. Patent pending and/or patent www.assaabloydss.com/patents.

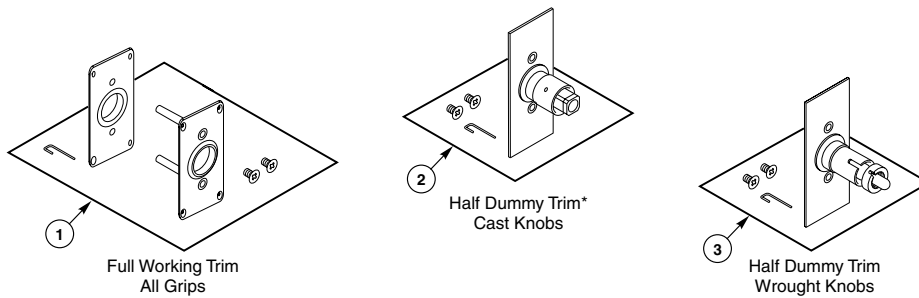

NOTE: Each adapter packet comes with appropriate size adapter plates & screws for door thickness as ordered.

Item	Part No.	Description
1		Adapter Packet - Full Working Trim, containing: 1 - Inside Adapter Plate 1 - Outside Adapter Plate 2 - #8-32 Phillips Flat Hd Undercut Machine Screws 1 - Knob Release Tool
	466F73	for 1-3/8" Door
	466F74	for 1-3/4" Door
	466F75	for 2-1/4" Door
2	440F17	Adapter Packet - Cast Knob x P Escutcheon Half Dummy Trim, containing: 1 - Adapter Plate 2 - #8-32 Phillips Flat Hd Undercut Machine Screws 1 - Adjusting Nut 1 - Spindle Sub Assembly 1 - Sleeve 1 - Spacer

Item	Part No.	Description
3	511F52	Adapter Packet - Wrought Knob, Half Dummy Trim, containing: 1 - Adapter Plate 2 - #8-32 Phillips Flat Hd Combination Screws 1 - Knob Release Tool 1 - Knob Catch 1 - Locknut Assembly 1 - Spindle Sub Assembly 1 - Knob Adapter

Adapter Packets - All Escutcheons - Half Working Trim



Item	Part No.	Description
1	427F06	Adapter Packet - Knob Half Working Trim, containing: 1 - Inside Adapter Plate

Item	Part No.	Description
2	488F27	Adapter Packet - Lever Half Working Trim, containing: 1 - Inside Adapter Plate

NOTE: Retainer 427F07-8 required for installation.

The warranty on Corbin Russwin products becomes void if the product is modified in any way, regardless of whether the modifications causes or contributes to any alleged defect. If a Corbin Russwin product is modified it may no longer meet industry certification and quality control standards applicable to the original product and is no longer a genuine Corbin Russwin product.

Copyright © 2000-2020, ASSA ABLOY Access and Egress Hardware Group, Inc. All rights reserved. Reproduction in whole or in part without the express written permission of ASSA ABLOY Access and Egress Hardware Group, Inc. is prohibited. Patent pending and/or patent www.assaabloydss.com/patents.

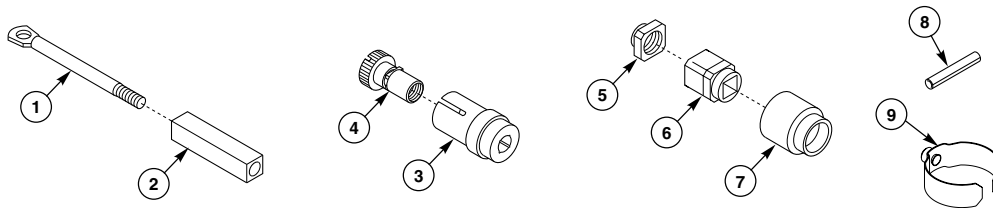

Item	Part No.	Description
1	483F34-8	Adjusting Bolt for Lever half Trim for: 1-3/8" Door
	483F35-8	1-3/4" Door
	483F36-8	2-1/4" Door
2	483F31-8	Inside Spindle for Lever Half Trim for: 1-3/8" Door
	680F35-8	1-3/4" Door
	483F33-8	2-1/4" Door
3	483F11-8	Knob Shank Adapter*

Item	Part No.	Description
4	482F37-5	Adjustable Locknut Assembly
5	118F48-8	Adjusting Nut for Cast Knob
6	497F52-8	Spacer for Cast Knob
7	Specify Finish	
	206F53-8	Sleeve for Cast Knob
8	228F54-8	Roll Pin for Knob or Lever Spindle
9	377F30-8	Catch Assembly, Knob

* Spring Clip not part of Knob Shank Adapter. Order item #9.

Spindles

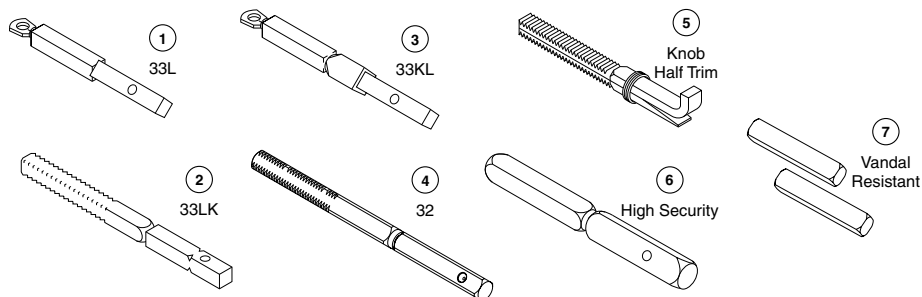

Item	Part No.	Description
1	499F82-8	33L (Lever x Lever) Spindle for: 1-3/8" Door
	499F83-8	1-3/4" Door
	499F84-8	2-1/4" Door
2	499F86-8	33LK (Lever x Knob) Spindle for: 1-3/8" Door
	499F87-8	1-3/4" Door
	499F88-8	2-1/4" Door
3	499F90-8	33KL (Knob x Lever) Spindle for: 1-3/8" Door
	499F91-8	1-3/4" Door
	499F92-8	2-1/4" Door

Item	Part No.	Description
4	696F57-8	32 (Knob x Knob) Spindle for: 1-3/8" Door
	696F58-8	1-3/4" Door
	696F59-8	2-1/4" Door
	696F60-8	Up to 4" Door
5	303F18-8	Spindle for Knob Half Trim for: 1-3/8" Door
	303F19-8	1-3/4" Door
	303F20-8	2-1/4" Door
6	445F41-8	High Security Spindle for: 1-3/4" Door
	498F84-8	2" Door
	498F85-8	2-1/4" Door
7	700F38-8	Vandal Resistant Spindles

The warranty on Corbin Russwin products becomes void if the product is modified in any way, regardless of whether the modifications causes or contributes to any alleged defect. If a Corbin Russwin product is modified it may no longer meet industry certification and quality control standards applicable to the original product and is no longer a genuine Corbin Russwin product.

Copyright © 2000-2020, ASSA ABLOY Access and Egress Hardware Group, Inc. All rights reserved. Reproduction in whole or in part without the express written permission of ASSA ABLOY Access and Egress Hardware Group, Inc. is prohibited. Patent pending and/or patent www.assaabloydss.com/patents.

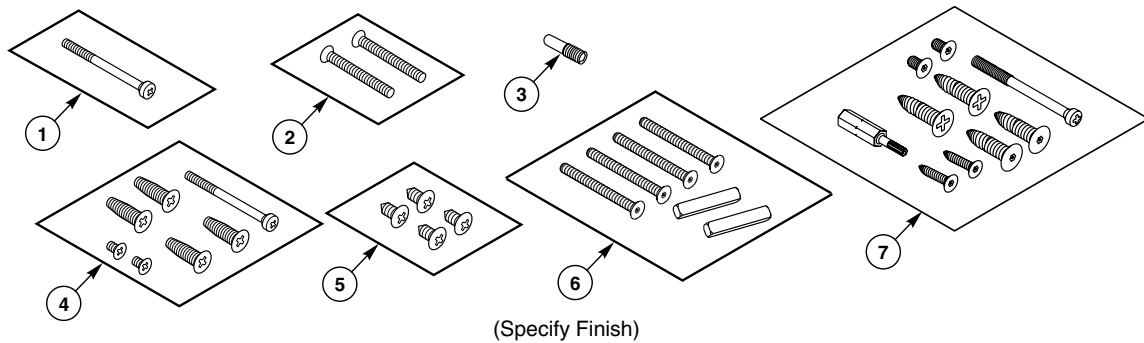

Item	Part No.	Description
1	488F08 488F10	Cylinder Set Screw Packet for Standard MR Option
2	433F76 433F77 433F78 439F33 439F34 439F35	Throughbolt Packet for M & P Escutcheons, containing: 2 - #8-32 Phillips Oval Hd Machine Screws for 1-3/8" Door for 1-3/4" Door for 2-1/4" Door Throughbolt Packet for R & L Escutcheons, containing: 2 - #10-24 Phillips Oval Hd Machine Screws for 1-3/8" Door for 1-3/4" Door for 2-1/4" Door
3	483F30	Dowel Screw for Inside Lever
4	429F41	Mortise Lock Mounting Packet, (Std.) containing: 1 - Cylinder Set Screw 4 - #12 Phillips Flat Head Undercut Combination Screws 2 - #8 x 1/4" Phillips Flat Head Undercut Machine Screws
5	429F31	Screw Packet for N Surface Mounted Escutcheons, containing: 4 - #6 x 1/2" Phillips Oval Head Type A Tapping Screws

Item	Part No.	Description
6	700F65 700F66 700F67	Screw & Spindle Packet for VR Trim Containing: 4 - #10 - 24 x 2" FHUM Torx® Pin Screws 2 - Spindles for 1-3/4" Door for 2" Door for 2-1/4" Door
7	616F12 368F97 383F34 614F90 614F95 688F07 616F07 465F57 402F91 383F34 614F90 614F95 688F07 616F07 488F09 488F10 383F34 221F51	Mortise Lock Mounting Packet, MR x Torx® (M04) containing: 1 - Cylinder Set Screw 2 - #12 Phillips FHU Combination Screws 2 - #12 x 1" FHU Torx® Pin Combination Screw 2 - #8-32 x 1/4" Torxv Pin FHMU Screw 2 - #6 x Torx® Pin Flat Head Screw 1 - Torx® Pin Driver Bit Mortise Lock Mounting Packet, HS & VR, containing: 1 - Cylinder Set Screw 2 - #12 Phillips FHU Combination Screws 2 - #12 x 1" FHU Torx® Pin Combination Screw 2 - #8-32 x 1/4" Torx® Pin FHMU Screw 2 - #6 x Torx® Pin Flat Head Screw 1 - Torx® Pin Driver Bit Mortise Lock Mounting Packet, MR, containing: 1 - Cylinder Set Screw 2 - #12 Phillips FHU Combination Screws 2 - #8-32 x 1/4" Phillips Flat Head Undercut Machine Screws

The warranty on Corbin Russwin products becomes void if the product is modified in any way, regardless of whether the modifications causes or contributes to any alleged defect. If a Corbin Russwin product is modified it may no longer meet industry certification and quality control standards applicable to the original product and is no longer a genuine Corbin Russwin product.

Copyright © 2000-2020, ASSA ABLOY Access and Egress Hardware Group, Inc. All rights reserved. Reproduction in whole or in part without the express written permission of ASSA ABLOY Access and Egress Hardware Group, Inc. is prohibited. Patent pending and/or patent www.assaabloydss.com/patents.

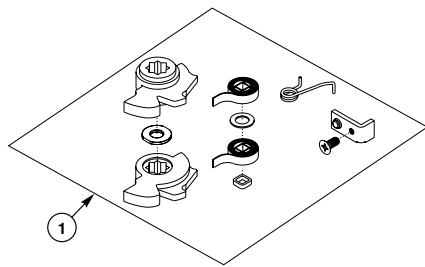

This kit converts locks from knob x knob to lever x lever operation.

Item	Part No.	Description
1	683F34	Mortise Lock Conversion Kit, for Locks with Movable Stops, containing:
	684F09-M	1 - Hub, Cap Side
	684F10-M	1 - Hub, Case Side
	684F11-9	1 - Spacer, Hub
	404F85-M	2 - Spring, Lever Return
	684F12-9	1 - Spacer, Spring
	466F22-9	1 - Spacer
	565F04-M	1 - Spring, Hub Lever
	404F86-M	1 - Bracket, Hub Alignment
	684F18-M	1 - Screw, FHUM-PH-TITE #8-32x3/8"

Miscellaneous Parts

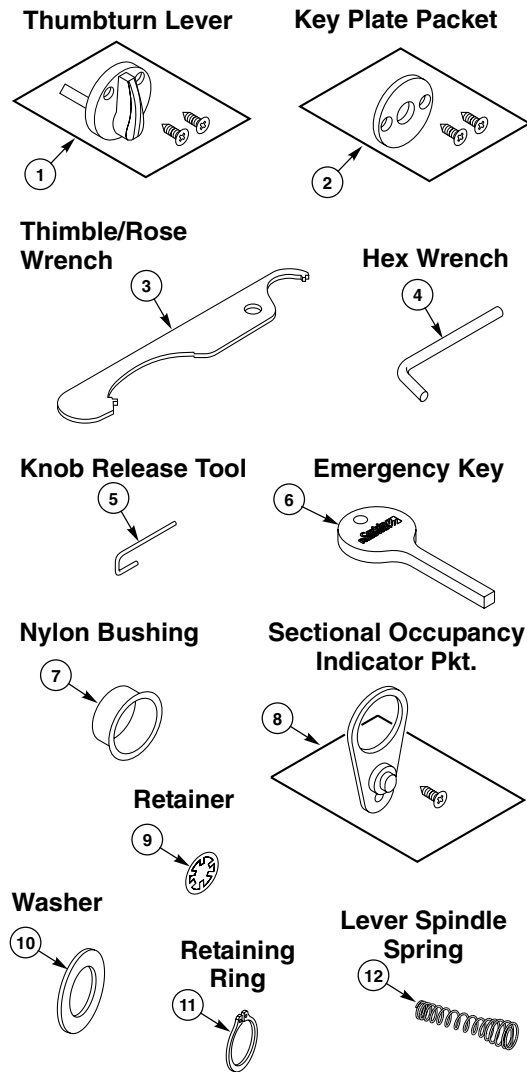

Item	Part No.	Description
	<i>Specify Finish</i>	Thumbturn Lever Packet, containing: 1 - Thumbturn Lever 2 - #6 x 1/2" Phillips Oval Head, Type A Screws
	519F09	for 1-3/8" Door
	519F10	for 1-3/4" Door
	519F11	for 2-1/4" Door
	519F12	for up to 3" Door
	581F96	for up to 4" Door
2	<i>Specify Finish</i>	Key Plate Packet, containing: 1 - Key Plate 2 - #6 x 1/2" Oval Truss Hd. Screws
3	300F68-8	Thimble/Rose Wrench
4	264F69-8	Hex Wrench
5	391F65-8	Knob Release Tool
6	605F42-8	Emergency Key for Privacy Function
7	118F29-9	Nylon Bushing for all Adapters & Cast Escutcheons
8		Sectional Trim Occupancy Indicator Packet, containing 1 - Indicator Assembly 1 - Indicator Collar 1 - #6 x 1/2" Phillips Oval Head Tapping Screw
	429F08	for 1-3/8" Door
	416F84	for 1-3/4" Door
	484F74	for 2-1/4" Door
9	427F07-8	Retainer
10	700F37-8	Washer for VR Trim
11	700F16-8	Retaining Ring for VR Trim
12	700F36-7	Lever Spindle Spring for VR Trim

The warranty on Corbin Russwin products becomes void if the product is modified in any way, regardless of whether the modifications causes or contributes to any alleged defect. If a Corbin Russwin product is modified it may no longer meet industry certification and quality control standards applicable to the original product and is no longer a genuine Corbin Russwin product.

Copyright © 2000-2020, ASSA ABLOY Access and Egress Hardware Group, Inc. All rights reserved. Reproduction in whole or in part without the express written permission of ASSA ABLOY Access and Egress Hardware Group, Inc. is prohibited. Patent pending and/or patent www.assaabloyds.com/patents.

Conventional (standard for ML2000)
 Security (standard for ML2000HS)
 Pyramid (optional)
 IC
 2 nickel silver keys
 Finishes: See Key Systems and Pyramid catalogs.

Pyramid
(Fixed Core)

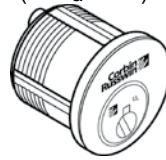

Conventional
(Fixed Core)

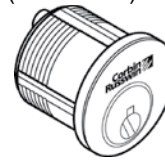

Interchangeable Core
(I.C.)

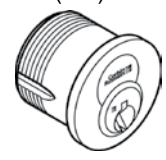

Pyramid
Shown

Mortise Cylinder Type	Hotel Function	55, 69* & (Inside) Function	All Other Keyed Functions
HS VR Access 3® Patented	1501-114-A01	1500-114-A02	1500-114-A01
HS VR Access 3® Security	1601-114-A01	1600-114-A02	1600-114-A01
HS VR Access 3® High Security	1701-114-A01	1700-114-A02	1700-114-A01
HS VR Access 3® Patented IC	N/A	1580-114-A02	1580-114-A01
HS VR Access 3® Security IC	N/A	1680-114-A02	1680-114-A01
HS VR Access 3® High Security IC	N/A	1788-114-A02	1788-114-A01
HS VR Pyramid PHS	N/A	1020-114-A02	1020-114-A01
HS VR Pyramid PCHS	N/A	1030-114-A02	1030-114-A01
HS VR Conventional 6-pin	1001-114-A01	1000-118-A02	1000-118-A01
HS VR 7-pin	N/A	1000-114-A02-7	1000-114-A01-7
HS VR 6-pin IC	1081-138-A01	1080-114-A02	1080-114-A01
HS VR 7-pin IC	N/A	1080-112-A02-7	1080-112-A01-7
HS VR Security IC	1091-138-A01	1090-114-A02	1090-114-A01
HS VR Security	1011-114-A01	1010-118-A02	1010-118-A01
Flex Head	1101-118-A01	1100-100-A02	1100-100-A01
Flex head 7-pin	N/A	1100-118-A02-7	1100-118-A01-7
Master ring	N/A	1060-118-A02-7	1060-118-A65**
Master ring flex head	N/A	1160-100-A62	1060-100-A65**
Plug only to show (concealed shell)	1201-114-A01	1200-118-A02	1200-118-A01
Plug only to show 7-pin (concealed shell)	N/A	1200-114-A02-7	1200-114-A01-7

For complete Pyramid information and options refer to Key Systems catalog.

To order cylinder separately, specify Part No. x Keyway x Finish (e.g. 1000-118-A01 x L4 x 626).

HS Indicates cylinder is available with ML2000HS lockset.

VR Indicates function is available with ML2000VR lockset.

*69 function is not offered with ML2000HS or ML2000VR.

**Deadbolt function require A61 cam.

The warranty on Corbin Russwin products becomes void if the product is modified in any way, regardless of whether the modifications causes or contributes to any alleged defect. If a Corbin Russwin product is modified it may no longer meet industry certification and quality control standards applicable to the original product and is no longer a genuine Corbin Russwin product.

Copyright © 2000-2020, ASSA ABLOY Access and Egress Hardware Group, Inc. All rights reserved. Reproduction in whole or in part without the express written permission of ASSA ABLOY Access and Egress Hardware Group, Inc. is prohibited. Patent pending and/or patent www.assaabloydss.com/patents.

For Standard Cylinder in ML2000 Series Locksets and Mortise Exit Devices with Sectional Trim

NOTES

1. There is no Corbin Russwin configuration which requires 1-3/8" cylinders in a double cylinder function. Collars for this combination are shaded and are referenced only for other manufacturer's cylinders.
2. The T & V-escutcheons is not available for 1-3/8" doors, so that configuration is not in this table.
3. Double cylinder functions use the same collar on both sides, unless otherwise specified.

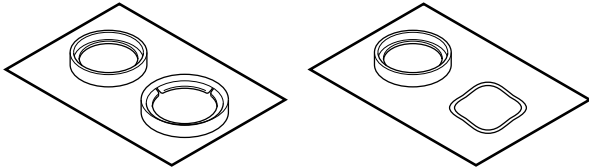

Application			Cylinder				
Door	Function	Trim	1" 5-Pin	1-1/8" 6-Pin Standard	1-1/4" 6-Pin IC, 7-Pin, Hotel, Blockout	1-3/8" Hotel IC	1-1/2" 7-Pin IC
1-3/8" Door	Single Cylinder	Sectional	253F97	605F43	447F43	609F36	609F37
		N escutcheon	253F97	253F97	605F43	605F43	609F37
		P escutcheon	253F97	610F01	447F43	609F36	609F37
		M escutcheon	253F97	253F97	605F43	609F36	609F37
		R escutcheon	none	447F42	610F01	447F43	609F36
		L escutcheon	none	447F42	610F01	447F43	609F37
	Double Cylinder	Sectional	605F43	609F36	609F37	609F38	609F38
		N escutcheon	605F43	447F43	609F36	609F37	609F37
		P escutcheon	610F01	447F43	609F36	609F37	609F37
		M escutcheon	610F01	447F43	609F36	609F37	609F37
		R escutcheon	610F01	447F43	609F36	609F37	609F37
		L escutcheon	610F01	447F43	609F36	609F37	609F37

The warranty on Corbin Russwin products becomes void if the product is modified in any way, regardless of whether the modifications causes or contributes to any alleged defect. If a Corbin Russwin product is modified it may no longer meet industry certification and quality control standards applicable to the original product and is no longer a genuine Corbin Russwin product.

Copyright © 2000-2020, ASSA ABLOY Access and Egress Hardware Group, Inc. All rights reserved. Reproduction in whole or in part without the express written permission of ASSA ABLOY Access and Egress Hardware Group, Inc. is prohibited. Patent pending and/or patent www.assaabloydss.com/patents.

Application			Cylinder				
Door	Function	Trim	1" 5-Pin	1-1/8" 6-Pin Standard	1-1/4" 6-Pin IC, 7-Pin, Hotel, Blockout	1-3/8" Hotel IC	1-1/2" 7-Pin IC
1-3/4" Door	Single Cylinder	Sectional	253F97	253F97	605F43	605F43	609F36
		N escutcheon	253F97	253F97	253F97	605F43	605F43
		P escutcheon	use longer cyl.	253F97	253F98	610F01	447F43
		M escutcheon	use longer cyl.	253F97	253F97	605F43	447F43
		R escutcheon	none	none	447F41	447F42	610F02
		T escutcheon	none	none	none	447F41	447F42
		L escutcheon	none	none	447F41	447F42	610F02
	V escutcheon	none	none	none	700F53	700F53	
	Double Cylinder	Sectional	253F97	610F01	447F43	609F37	609F37
		N escutcheon	253F97	253F97	605F43	447F43	609F36
		P escutcheon	447F41 x none	447F42	610F02	447F43	609F36
		M escutcheon	253F97 x none	253F97	605F43	447F43	609F36
		R escutcheon	197F34 x none	447F41	447F42	610F02	447F43
		T escutcheon	none	447F41	447F42	610F02	609F36
L escutcheon		197F34 x none	447F42	610F01	447F43	609F36	
V escutcheon	none	none	700F53	700F53	705F92		
2" Door	Single Cylinder	Sectional	253F97	253F97	253F97	605F43	605F43
		N escutcheon	use longer cyl.	253F97	253F97	253F97	605F43
		P escutcheon	none	use longer cyl.	253F97	447F42	610F01
		M escutcheon	none	use longer cyl.	253F97	253F97	605F43
		R escutcheon	none	none	none	447F41	447F42
		T escutcheon	use longer cyl.	use longer cyl.	none	none	447F41
		L escutcheon	none	none	none	447F41	447F42
	V escutcheon	not available	none	none	none	700F53	
	Double Cylinder	Sectional	447F41	253F97	605F43	447F43	609F36
		N escutcheon	447F41	253F97	253F97	605F43	447F43
		P escutcheon	447F41 x none	447F41 x none	447F42	610F02	447F43
		M escutcheon	253F97 x none	253F97 x none	253F97	605F43	447F43
		R escutcheon	none	197F34 x none	447F42	610F02	447F43
		T escutcheon	use longer cyl.	none	447F41	447F42	610F02
L escutcheon		none	197F34 x none	447F42	610F02	447F43	
V escutcheon	not available	not available	none	not available	700F53		

The warranty on Corbin Russwin products becomes void if the product is modified in any way, regardless of whether the modifications causes or contributes to any alleged defect. If a Corbin Russwin product is modified it may no longer meet industry certification and quality control standards applicable to the original product and is no longer a genuine Corbin Russwin product.

Copyright © 2000-2020, ASSA ABLOY Access and Egress Hardware Group, Inc. All rights reserved. Reproduction in whole or in part without the express written permission of ASSA ABLOY Access and Egress Hardware Group, Inc. is prohibited. Patent pending and/or patent www.assaabloydss.com/patents.



Application			Cylinder				
Door	Function	Trim	1" 5-Pin	1-1/8" 6-Pin Standard	1-1/4" 6-Pin IC, 7-Pin, Hotel, Blockout	1-3/8" Hotel IC	1-1/2" 7-Pin IC
2-1/4" Door	Single Cylinder	Sectional	use longer cyl.	253F97	253F97	253F97	605F43
		N escutcheon	use longer cyl.	253F97	253F97	253F97	253F97
		P escutcheon	use longer cyl.	use longer cyl.	use longer cyl.	253F97	253F98
		M escutcheon	use longer cyl.	use longer cyl.	use longer cyl.	253F97	253F97
		R escutcheon	use longer cyl.	use longer cyl.	none	none	447F41
		T escutcheon	use longer cyl.	use longer cyl.	use longer cyl.	none	none
		L escutcheon	use longer cyl.	use longer cyl.	none	none	447F41
		V escutcheon	none	none	none	none	none
	Double Cylinder	Sectional	447F41	447F41	253F97	605F43	447F43
		N escutcheon	use longer cyl.	447F41	253F97	253F97	605F43
		P escutcheon	use longer cyl.	447F41 x none	447F41 x none	447F42	610F02
		M escutcheon	use longer cyl.	253F97 x none	253F97 x none	253F97	605F43
		R escutcheon	use longer cyl.	none	197F34 x none	447F42	610F02
		T escutcheon	use longer cyl.	none	none	447F41	447F42
L escutcheon	use longer cyl.	none	197F34 x none	447F42	610F02		
V escutcheon	none	none	none	none	none	none	

The warranty on Corbin Russwin products becomes void if the product is modified in any way, regardless of whether the modifications causes or contributes to any alleged defect. If a Corbin Russwin product is modified it may no longer meet industry certification and quality control standards applicable to the original product and is no longer a genuine Corbin Russwin product.

Copyright © 2000-2020, ASSA ABLOY Access and Egress Hardware Group, Inc. All rights reserved. Reproduction in whole or in part without the express written permission of ASSA ABLOY Access and Egress Hardware Group, Inc. is prohibited. Patent pending and/or patent www.assaabloydss.com/patents.

Master Ring Collars for Master Cylinders in ML2000 Series Locksets

Door	Application		Cylinder		
	Function	Trim	1-1/8" Standard	1-1/4"	1-3/8" 7-Pin
1-3/8"	Single Cylinder	Sectional	447F46	447F46	not avail.
		N escutcheon	447F45*	447F46	447F46
M escutcheon		447F45*	447F46	not avail.	
1-3/8"	Double Cylinder	Sectional	not avail.		
		N escutcheon	447F46	use shorter cyl.	not avail.
M escutcheon		447F46			
1-3/4"	Single Cylinder	Sectional	447F45*	447F45*	447F46
		N escutcheon	447F44*	447F44*	447F45*
M escutcheon		447F44*	447F44*	447F45*	
1-3/4"	Double Cylinder	Sectional	447F46	use shorter cyl.	not avail.
		N escutcheon	447F45*	447F46	447F46
M escutcheon		447F45*	447F46	not avail.	
2"	Single Cylinder	Sectional	447F44	447F45*	447F45*
		N escutcheon	447F44	447F44*	447F44*
M escutcheon		none	447F44*	447F44*	
2"	Double Cylinder	Sectional	447F45*	447F46	not avail.
		N escutcheon	447F44	447F45*	447F46
M escutcheon		447F44 x none	447F45*	447F46	
2-1/4"	Single Cylinder	Sectional	447F44	447F44	447F45*
		N escutcheon	use longer cyl.	447F44	447F44*
M escutcheon		use longer cyl.	none	447F44*	
2-1/4"	Double Cylinder	Sectional	447F44	447F45*	447F46
		N escutcheon	447F44	447F44	447F45*
M escutcheon		447F44 x none	447F44 x none	447F45*	

*ML2042 and ML2055 require 447F46

The warranty on Corbin Russwin products becomes void if the product is modified in any way, regardless of whether the modifications causes or contributes to any alleged defect. If a Corbin Russwin product is modified it may no longer meet industry certification and quality control standards applicable to the original product and is no longer a genuine Corbin Russwin product.

Copyright © 2000-2020, ASSA ABLOY Access and Egress Hardware Group, Inc. All rights reserved. Reproduction in whole or in part without the express written permission of ASSA ABLOY Access and Egress Hardware Group, Inc. is prohibited. Patent pending and/or patent www.assaabloydss.com/patents.

Conventional Cylinder

Application		Cylinder		
Door	Function	1" 6-Pin std.	1-1/8" 7-Pin Std.	1-1/4"
1-3/8"	Single Cylinder	370F29	252F82	Use Shorter Cylinder
1-3/4"	Single Cylinder	none	370F29	370F31
	Double Cylinder	370F31	252F82	Use Shorter Cylinder
2"	Single Cylinder	none	none	370F29
	Double Cylinder	none	370F31	252F82
2-1/4"	Single Cylinder	Use Longer Cylinder	none	none
	Double Cylinder	none	none	370F31

Master Ring

Application		Cylinder		
Door	Function	1" 6-Pin std.	1-1/8" 7-Pin Std.	1-1/4"
1-3/8"	Single Cylinder	370F35	370F35	Use Shorter Cylinder
1-3/4"	Single Cylinder	none	370F33	370F35
	Double Cylinder	370F35	370F35	Use Shorter Cylinder
2"	Single Cylinder	none	none	370F33
	Double Cylinder	370F33	370F35	370F35
2-1/4"	Single Cylinder	Use Longer Cylinder	none	none
	Double Cylinder	none	370F33	370F35

The warranty on Corbin Russwin products becomes void if the product is modified in any way, regardless of whether the modifications causes or contributes to any alleged defect. If a Corbin Russwin product is modified it may no longer meet industry certification and quality control standards applicable to the original product and is no longer a genuine Corbin Russwin product.

Copyright © 2000-2020, ASSA ABLOY Access and Egress Hardware Group, Inc. All rights reserved. Reproduction in whole or in part without the express written permission of ASSA ABLOY Access and Egress Hardware Group, Inc. is prohibited. Patent pending and/or patent www.assaabloydss.com/patents.

Step 1) Move the Red locking screw to side of lock-body being locked (Fig. 1)

Step 2) Push in latch then depress catch plate with screw driver (Fig. 1)

Step 3) Pull latch out of lock-body and turn latch over (Fig. 2)

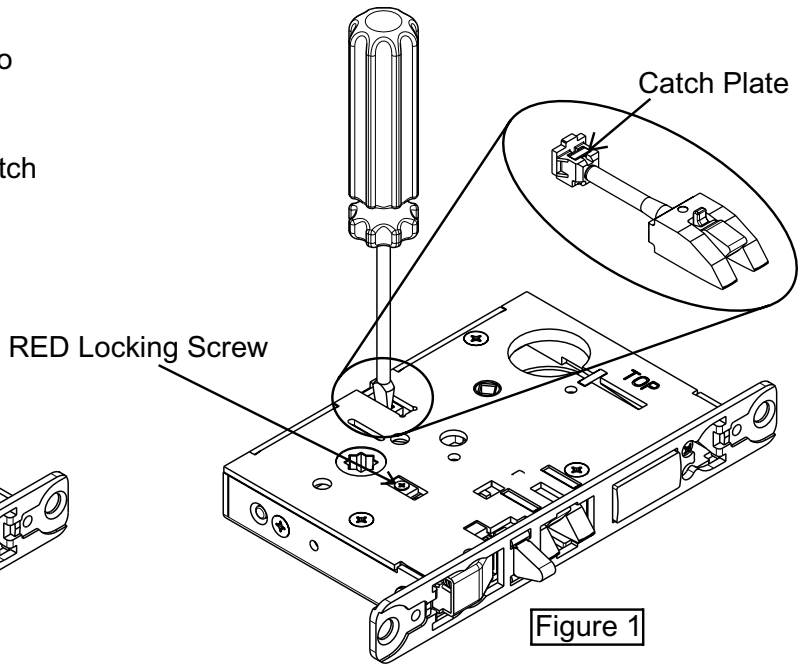
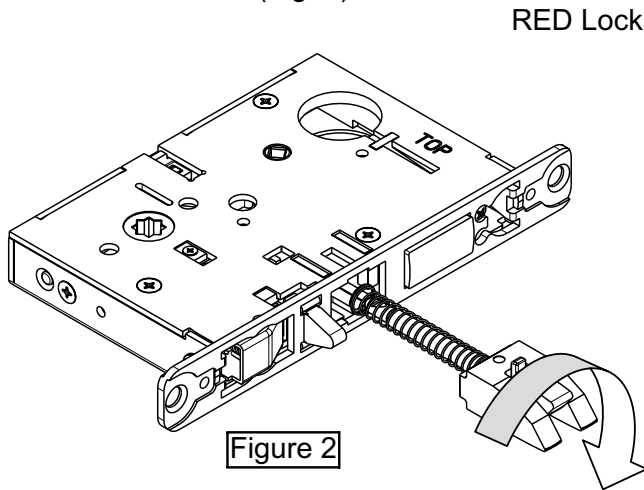

Step 4) Push in latch while holding screw driver behind latch tail (Fig. 3)

Note: Push in latch until catch plate is no longer depressed (Fig. 4)

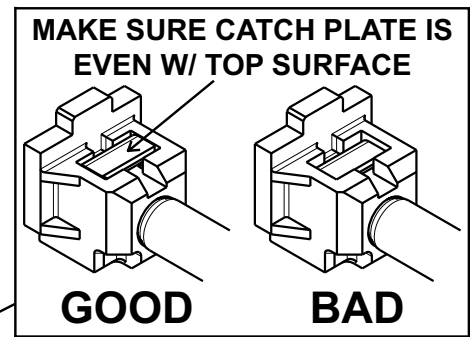

Step 5) Rotate lock front to match level of door as shown (Fig. 5)

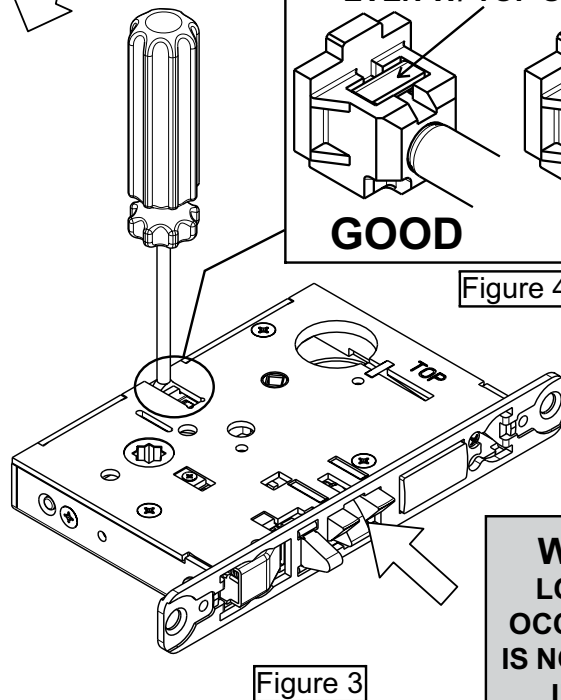
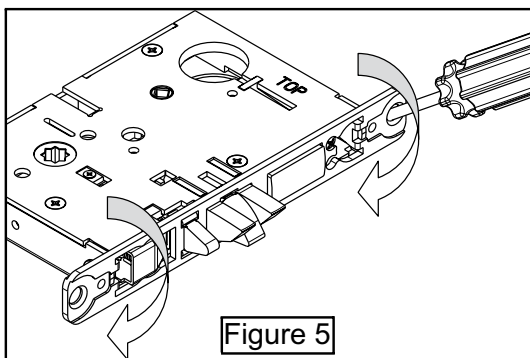

WARNING:
LOCK-IN CAN OCCUR IF LATCH IS NOT PROPERLY INSTALLED

The warranty on Corbin Russwin products becomes void if the product is modified in any way, regardless of whether the modifications causes or contributes to any alleged defect. If a Corbin Russwin product is modified it may no longer meet industry certification and quality control standards applicable to the original product and is no longer a genuine Corbin Russwin product.

Copyright © 2000-2020, ASSA ABLOY Access and Egress Hardware Group, Inc. All rights reserved. Reproduction in whole or in part without the express written permission of ASSA ABLOY Access and Egress Hardware Group, Inc. is prohibited. Patent pending and/or patent www.assaabloydss.com/patents.

The warranty on Corbin Russwin products becomes void if the product is modified in any way, regardless of whether the modifications causes or contributes to any alleged defect. If a Corbin Russwin product is modified it may no longer meet industry certification and quality control standards applicable to the original product and is no longer a genuine Corbin Russwin product.

Copyright © 2000-2020, ASSA ABLOY Access and Egress Hardware Group, Inc. All rights reserved. Reproduction in whole or in part without the express written permission of ASSA ABLOY Access and Egress Hardware Group, Inc. is prohibited. Patent pending and/or patent www.assaabloydss.com/patents.

The ASSA ABLOY Group is the global leader in access solutions. Every day, we help billions of people experience a more open world.

ASSA ABLOY Opening Solutions leads the development within door openings and products for access solutions in homes, businesses and institutions. Our offering includes doors, frames, door and window hardware, locks, perimeter fencing, access control and service.



For additional information, contact your
ASSA ABLOY Door Security Solutions
sales consultant or visit www.corbinrusswin.com.

In U.S.

Corbin Russwin
Architectural Hardware
225 Episcopal Road
Berlin, CT 06037
Phone: 800-543-3658
Fax: 800-447-6714
www.corbinrusswin.com

In Canada

ASSA ABLOY Door
Security Solutions Canada
160 Four Valley Drive
Vaughan, Ontario
Canada L4K 4T9
Phone: 800-461-3007
Fax: 800-461-8989
www.assaabloydss.ca



MicroShield®

As part of their promise to provide innovative solutions to their customers, certain ASSA ABLOY Group brands offer the MicroShield® technology, registered with the EPA and FDA. MicroShield® is a silver-based antimicrobial coating designed to inhibit the growth of bacteria. MicroShield® is a registered trademark of Yale Security Inc., an ASSA ABLOY Group company.