

ML2000 Series Mortise Lock

Used with Sectional Indicator Trim and V Series Indicators

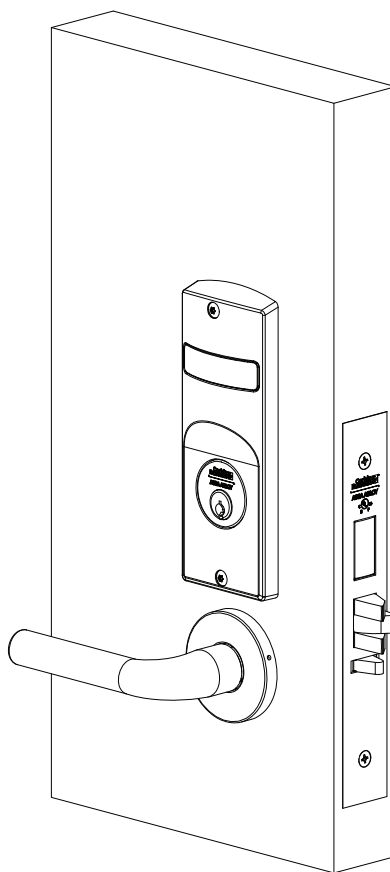

WARNING

This product can expose you to lead which is known to the state of California to cause cancer and birth defects or other reproductive harm. For more information go to www.P65warnings.ca.gov.

WARNING

Attention Installer: Improper installation may result in damage to the product and void the factory warranty.

ML2000 Series Mortise Lock

Used with Sectional Indicator Trim and V Series Indicators



ASSA ABLOY

Installation Instructions

TOC	Table of Contents
1	Tools Required2
2	Indicator Variants.....3
3	Mortise Lock Handing3
4	Rehanding Indicator (if required).....4
5	Installation5
a	Prepare Door for Mortise Lock5
b	Install Strike and Lock5
c	Prepare Door For Indicator5
d	Install Levers6
e	Install Indicator Mounting Plate.....8
f	Install Indicator Assembly8
g	Install Cylinder8
h	Install Outside Front9
i	Perform Functional Check9
6	Indicator Parts..... 10
1	Tools Required



#1, #2 & #3
Phillips head
screwdrivers

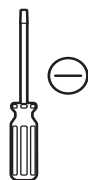

Flat blade
screwdriver



Allen wrench

- 1/8" for standard levers
- 3/32" for Muséo® levers
- 7/64" for EAC mortise locks



3/32" Drill bit



T-20 Torx Screw with
Tamper Pin Driver

ML2000 Series Mortise Lock

Used with Sectional Indicator Trim and V Series Indicators



ASSA ABLOY

Installation Instructions

2

Indicator Variants

Depending on function and option ordered, indicators are provided in the following variations, these instructions detail how to install with cylinder, however other variations follow similar instructions. (Figure 1)

Contact factory with questions.

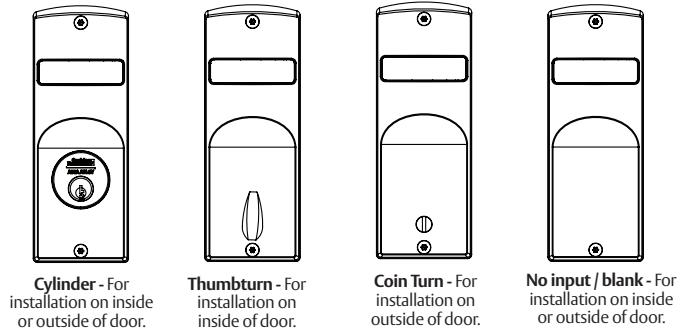

Figure 1

3

Mortise Lock Handing

1. Move red locking screw to side of lock body being locked.
 2. Push in latch. Depress catch plate with screwdriver. (Figure 2)
 3. Pull latch out of lock body and turn latch over. (Figure 3)
 4. Push in latch while holding screwdriver behind latch tail. (Figure 5)
- Note:**
Ensure latch is pushed in until catch plate is no longer depressed. (Figure 4)
5. Rotate lock front to match bevel of door, as shown. (Figure 6)

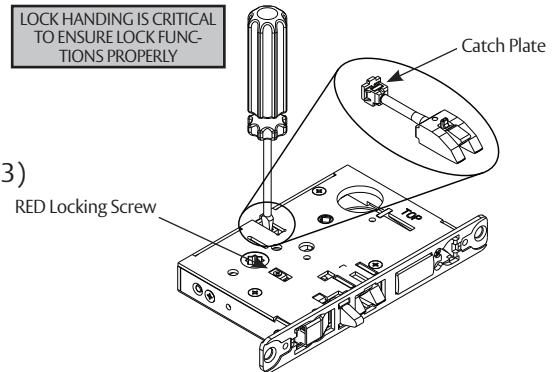

Figure 2

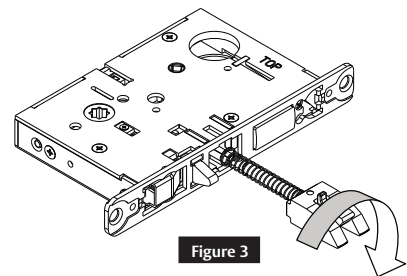

Figure 3

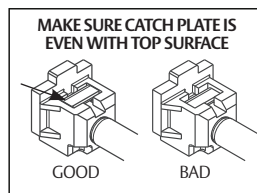

Figure 4

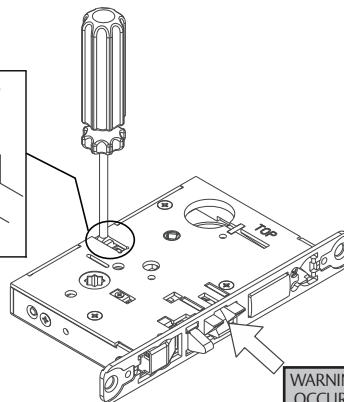

Figure 5

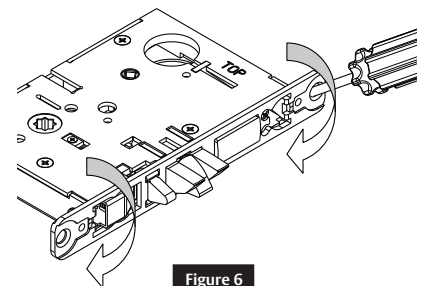

Figure 6

4

Rehanding Indicator (if required)

Indicator spindle cams MUST be oriented correctly per lock function and door mounting location. Verify hand and bevel of door. (Figure 7)

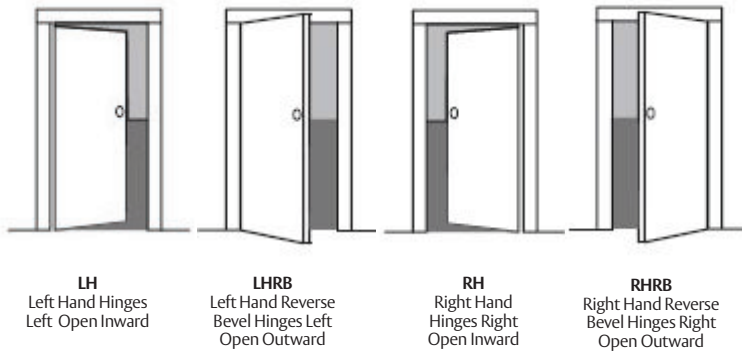

Figure 7



Scan this QR code for the Corbin Russwin Indicator Handing Charts

Note:

Stand outside of locked door when determining door hand.

Next, verify inside and/or outside indicators are handed correctly using Spindle Cam Position chart. (Figure 8)

If they are handed correctly, skip to Step 5a "Prepare Door for Mortise Lock."

If they are not handed correctly:

1. Remove retaining pad and spindle cam from assembly. (Figure 9)
2. Position spindle cam in correct direction for door hand. (Figure 8)

Important: For thumbturn indicators, make sure thumbturn is positioned in the 12 o'clock direction as shown. (Figure 10)

3. Slide spindle cam post into correct slot of display slide. (Figure 9)
4. Re-seat retaining pad into original position.
5. Return indicator to vacant/unlocked position for installation.

Spindle Cam Position

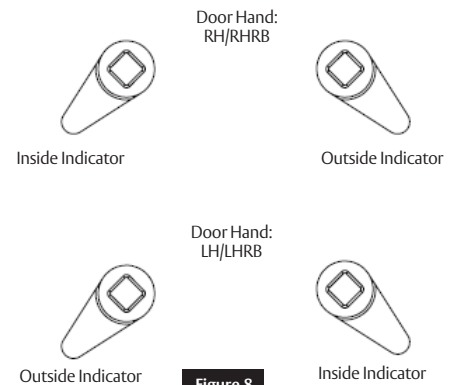

Figure 8

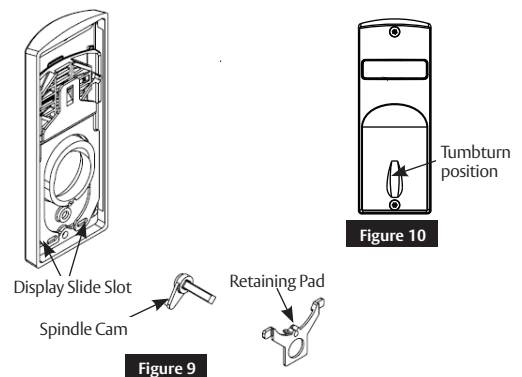

Figure 9

Figure 10

ML2000 Series Mortise Lock

Used with Sectional Indicator Trim and V Series Indicators



ASSA ABLOY

Installation Instructions

5

Installation

a

Prepare Door for Mortise Lock

Prepare door for function holes, size, and location according to FM9500 door marker template, if not already prepped.

b

Install Strike and Lock

1. Install strike using two (2) 3/4" combination screws. If strike box is needed, insert between strike and door frame. (Figure 11)
2. Make sure handing of lock matches handing of door.
3. Insert mortise lock into door and hand tighten two (2) 1" combination screws. (Figure 12)
 - Do NOT tighten completely at this time.

Notes:

- Keep door open until installation is complete.
- Make sure lock is unlocked. If lock has a toggle, push bottom of toggle inward to ensure it is unlocked during installation.

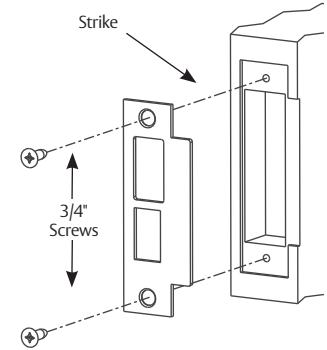
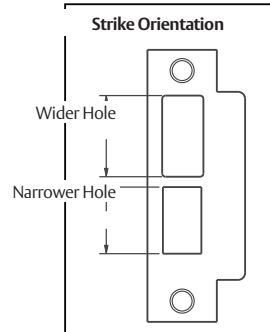

Figure 11

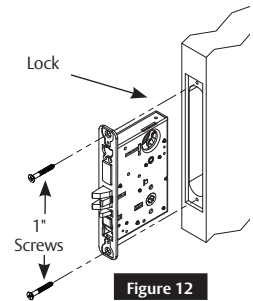

Figure 12

c

Prepare Door For Indicator

1. Insert template guide into control hub on side where indicator will be used.
2. Slide indicator template over template guide. (Figure 13)
 - Important:** Make sure template is properly centered and aligned to ensure smooth indicator operation.
3. Mark the four (4) hole positions indicated on template.
4. Remove guide and template.
5. If indicators are being used on both sides of door, repeat steps 1 through 4 for opposite side.
6. Remove lock body.
7. Drill four (4) marked holes with 3/32" diameter bit, by 1/2" deep.
8. Reinstall lock body and hand tighten screws.

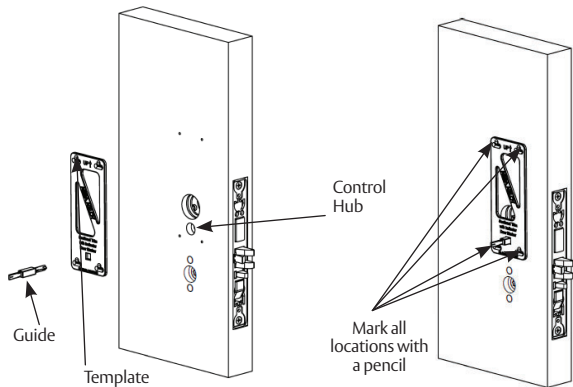

Figure 13

Note:

If retrofitting over existing product, ensure door surface is free of chips and debris around holes. As a result, indicator will sit flat against door surface.

5

Installation (cont.)

d

Install Levers

Standard Levers

1. Install outside and inside adapter plates. (Figure 14)
2. Screw roses onto adapter plates. (Figure 15)
3. Install outside lever or knob by inserting adjustment bolt on opposite side of door. Tighten bolt finger-tight and then loosen a few turns. (Figure 16)
4. Install inside lever or knob by inserting dowel screw. (Figure 18)

Note:

Use correct spindle orientation. (Figure 17)

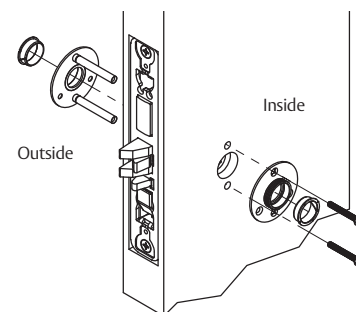

Figure 14

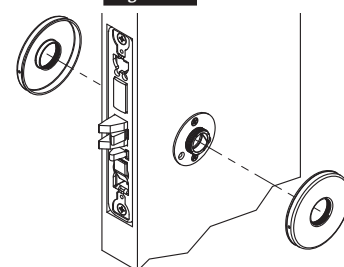

Figure 15

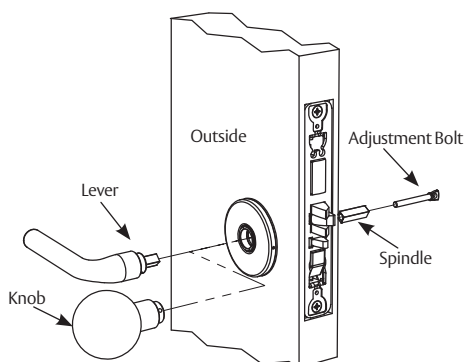

Figure 16

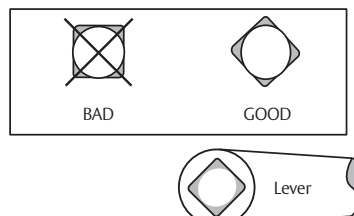

Figure 17

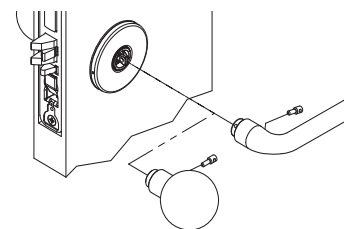

Figure 18

Note:

Make sure adjustment bolt hole is aligned with lever or knob hole. (Figure 19)

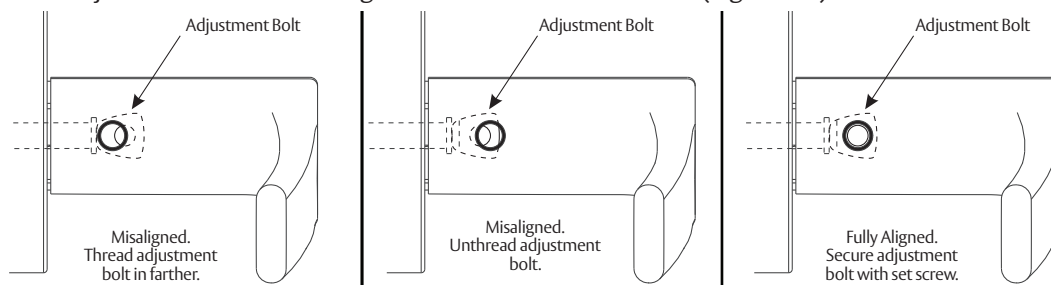

Figure 19

5

Installation (cont.)

d

Install Levers (cont.)

Muséo® Levers

1. Thread adapter plate hub into lever and fully tighten. (Figure 20)
2. Align adapter plate hub with square hole in lever; keep hub as tight as possible. (Figure 21)

Notes:

- Use spindle to help thread hub into lever.
- Use correct spindle orientation. (Figure 22)

3. Install outside trim assembly. (Figure 23)
4. Install inside adapter plate. (Figure 24)
5. Install inside spindle and rose. (Figure 25)

Note:

Align studs on rose with bushings in adapter plate.

6. Install inside lever with set screw. (Figure 26)

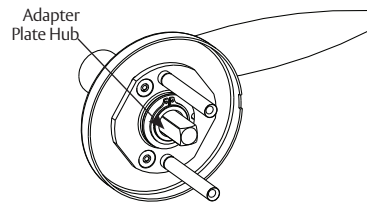

Figure 20

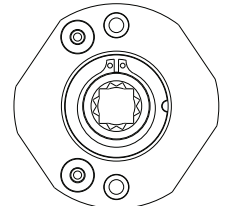

Figure 21



Figure 22

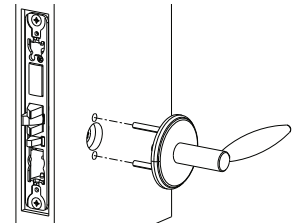

Figure 23

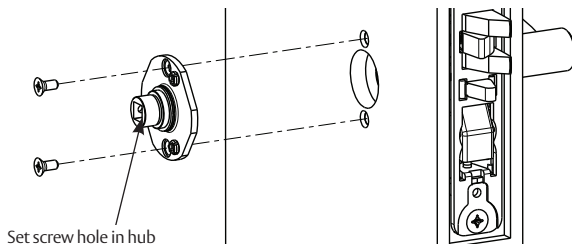

Figure 24

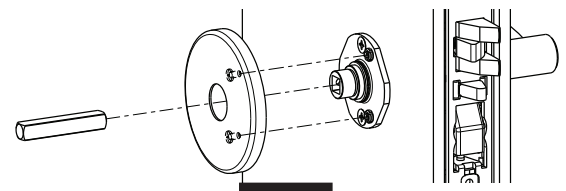

Figure 25

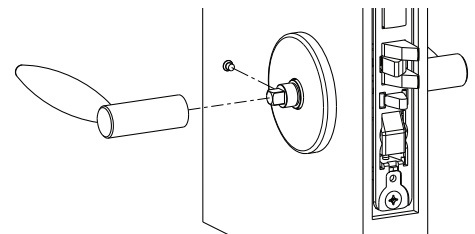

Figure 26

ML2000 Series Mortise Lock

Used with Sectional Indicator Trim and V Series Indicators

Corbin
Russwin

ASSA ABLOY

Installation Instructions

5

Installation (cont.)

e

Install Indicator Mounting Plate

1. Screw indicator mounting plate to door with four (4) #6 x 3/8" sheet metal screws. (Figure 27)
2. If indicators are being used on both sides of door, repeat step 1 for opposite side.

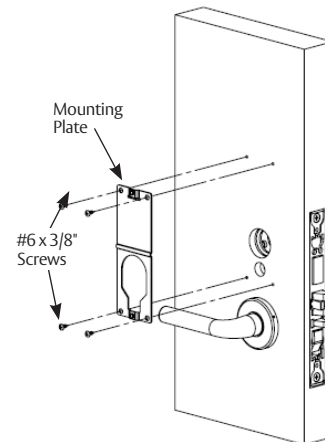

Figure 27

f

Install Indicator Assembly

1. Verify lock is in unlocked state (turn outside lever to confirm). Also, verify indicator is in the vacant/unlocked position.
2. Align spindle with diamond hole in Control Hub and assemble indicator onto backing plate. (Figure 28)
3. Secure indicator assembly to door with two (2) machine screws. (Figure 29)
 - Use #8-32 x 5/8" screw for top
 - Use #8-32 x 3/8"
4. If indicators are being used on both sides of door, repeat steps 1 through 3 for opposite side.

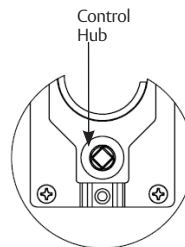

Figure 28

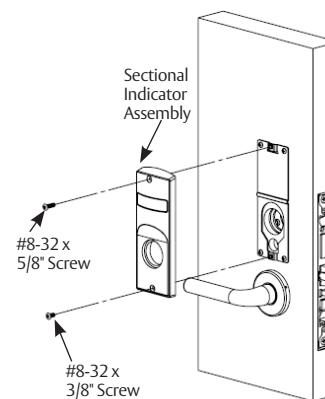

Figure 29

Note:

Torx security screws recommended.

g

Install Cylinder

1. Thread cylinder into lock until flush with escutcheon surface. (Figure 30)
 - Pull key slightly out of cylinder to help thread into lock body.
2. Install cylinder clamp screw with #1 Phillips screwdriver.
 - Check operation, and adjust cylinder if necessary.

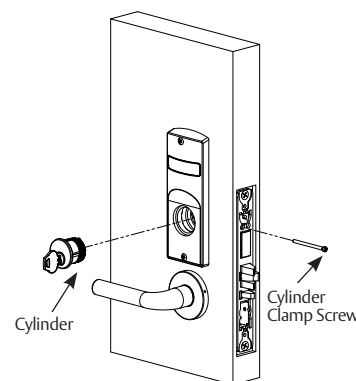
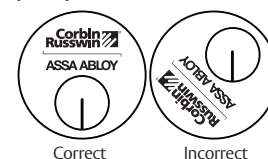

Figure 30

Notes:

- Corbin Russwin logo must be horizontal and on top. (Figure 31)
- If double cylinder function is used, repeat steps 1 and 2 for second cylinder.

Key and cylinder must be rotated as shown:



Correct Incorrect

Figure 31

ML2000 Series Mortise Lock

Used with Sectional Indicator Trim and V Series Indicators

**Corbin
Russwin**

ASSA ABLOY

Installation Instructions

5

Installation (cont.)

h

Install Outside Front

1. Tighten the two (2) lock screws completely. (Figure 32)
2. Attach outside front with two (2) flat head screws #8-32 x 1/4".

i

Perform Functional Check

DO NOT FORCE if resistance is encountered during functional check. Refer back to Rehanding Indicator (if required) section to ensure correct handing. Rehand if necessary.

1. Insert key into cylinder (if present) and rotate:
 - Ensure there is no friction against lock case, or any other obstructions.
2. Check key retracts latch:
 - Key should rotate freely.
3. Throw deadbolt (if present):
 - Check key retracts both deadbolt and latch.
4. Test levers:
 - Confirm latch and deadbolt (if installed) retract.
5. Verify indicator displays correct status when locked and unlocked.

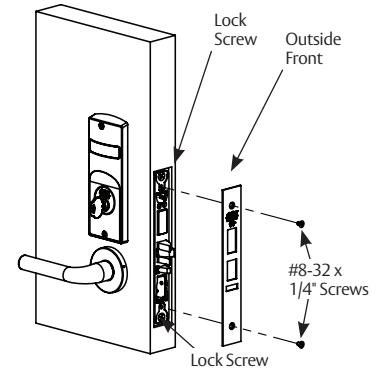

Figure 32

ML2000 Series Mortise Lock

Used with Sectional Indicator Trim and V Series Indicators

Installation Instructions



ASSA ABLOY

6

Indicator Parts

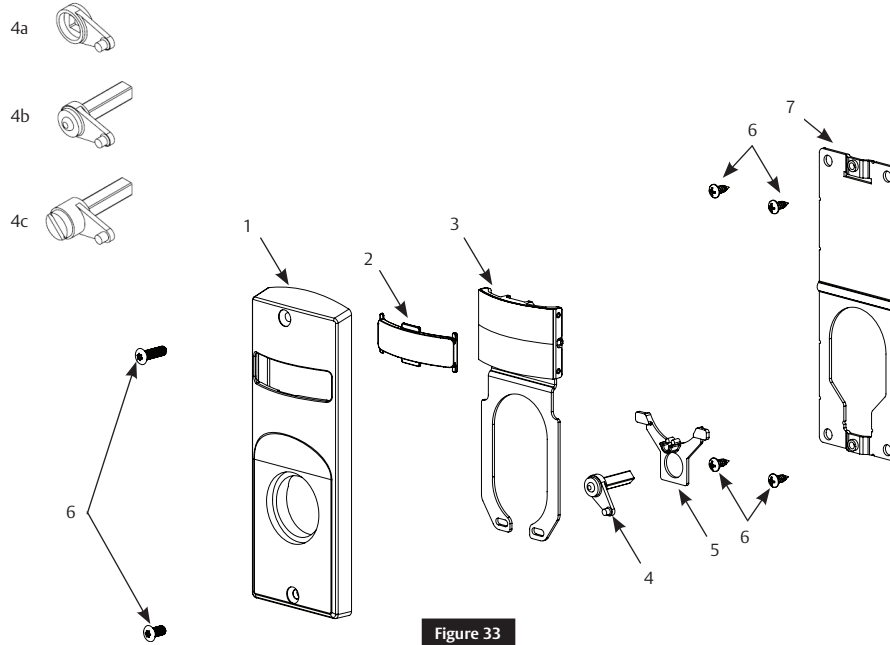

Figure 33

Figure 33	Description	Part Number	Required
1	Sectional Escutcheon - Cylinder	855F592 FIN	1
	Sectional Escutcheon - Coin Turn	855F582 FIN	
	Sectional Escutcheon - Thumbturn (Standard)	855F052 FIN	
	Sectional Escutcheon - Thumbturn (M34 Option)	855F062 FIN	
	Sectional Escutcheon - Thumbturn (T1)	855F072 FIN	
	Sectional Escutcheon - Thumbturn (T2)	855F082 FIN	
	Sectional Escutcheon - Thumbturn (T3)	855F092 FIN	
	Sectional Escutcheon - No Input / Blank	855F602 FIN	
2	Indicator Window	856F049	1
3	Indicator Display Assembly - Green Unlocked / Red Locked	858F241	1
	Indicator Display Assembly - Green Vacant / Red Occupied	858F251	
	Indicator Display Assembly - Green Unlocked Icon / Red Locked Icon	858F261	
	Indicator Display Assembly - White Unlocked / Red Locked	858F271	
	Indicator Display Assembly - White Vacant / Red Occupied	858F281	
	Indicator Display Assembly - White Unlocked Icon / Red Locked Icon	858F291	
4a	Indicator Spindle Cam - Thumbturn	855F619	1
4b	Indicator Spindle Cam - Cylinder / No Input / Blank	855F707*	1
4c	Indicator Spindle Cam - Coin Turn	855F747*	1
5	Indicator Retaining Pad	855F649	1
6	Sectional Indicator Screw Pack	858F497 FIN	1
7	Sectional Indicator Mounting Plate	855F658	1
8	Sectional Indicator Template Kit (not shown)	858F549	1

* These parts are for 1-3/4" standard thickness doors. For other thicknesses, please contact factory.

Note:

Reference ML2000 parts manual for all lock body parts.

ML2000 Series Mortise Lock

Used with Sectional Indicator Trim and V Series Indicators

Installation Instructions



ASSA ABLOY

Page intentionally left blank.

