



# TL3700 Series Tubular Locksets

## Product Catalog

Experience a safer  
and more open world

# Introduction

## TL3700 Series

### Table of Contents

Introduction.....	2
Functions.....	3
Muséo® Trim Designs.....	4
Roses.....	12
Strikes.....	13
Finishes.....	14
How to Order/Quick Codes.....	14
Architectural Specifications.....	16

Visit the Decorative Hardware online product selector at [selector.corbinrusswin.com](http://selector.corbinrusswin.com) to mix and match door trim and finishes.

### TL3700 Series Tubular Lock

Corbin Russwin is pleased to present the TL3700 Series of tubular locks. This series is designed to work with Corbin Russwin Muséo® levers. Engineered for ease of installation with the quality you expect from Corbin Russwin, the TL3700 Series will meet and exceed the expectations of the most demanding architects and design professionals. Ideal interior applications include high-end apartments and condos.



#### General Information

- For doors 1-3/8" (35mm) to 1-3/4" (44mm) thick standard
- 2-3/4" (70mm) backset standard  
Optional: 2-3/8" (60mm); see quick codes; page 14
- Curved lip T-Strike
- Door prep conforms to ANSI/BHMA A156.115
- Latchbolt brass 1/2" (13mm) projection
- Specify hand of lock on order; easily field reversible
- UL-cUL - Fire listing is optional and must be specified FOR A label and lesser class doors, 4' (122cm) x 10' (305cm) single or 8' (244cm) x 10' (305cm) pair. Letter F and UL symbol on armored front indicate listing.
- One-year limited warranty

### TL3700 Series Tubular Lock with Inspire™ Roseless Trim\*

Corbin Russwin *Inspire* roseless trim blends the lever and the door creating an artful approach to every opening. Offered with most Muséo® decorative levers, this exquisite trim will inspire the creation of beautiful openings.

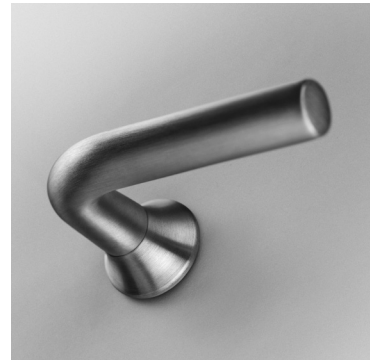

- Available with all TL3700 Series tubular lock functions (except surface mounted trim)
- Compatible with most Muséo levers (except 104, 111, 121, Piet, Josef and Georges Collection levers)
- Selected levers return within 1/2" of the door face





#### General Information

- For doors 1-3/4" (44mm) thick
- 2-3/4" (70mm) backset standard  
Optional: 2-3/8" (60mm); see quick codes; page 14
- Latchbolt brass 1/2" (13mm) projection
- Curved lip T-Strike
- Specify hand of lock on order; easily field reversible
- UL-cUL - Fire listing is optional and must be specified for A label and lesser class 4' x 10' single doors. Letter F and UL symbol on latch front indicate listing.
- One-year limited warranty

**\*Note: Special door prep templates required. This product is not compatible with standard cylindrical lock preparations.**

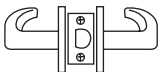
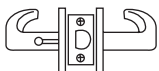
# Functions

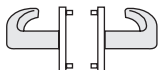
## TL3700 Series

	Series/Function	Type	Description
	TL3710 TL3710A	Passage Passage 3 hour	<ul style="list-style-type: none"> <li>• Both levers retract latch</li> <li>• Ideal for closets &amp; bedrooms</li> </ul>
	TL3720 TL3720A	Privacy Privacy 3 hour	<ul style="list-style-type: none"> <li>• Inside lever always retracts latch</li> <li>• Outside lever retracts latch, except when locked by inside push button</li> <li>• Closing door unlocks outside lever</li> <li>• Includes emergency release</li> <li>• Ideal for bathrooms &amp; home offices</li> </ul>
	TL3750	Half Dummy Trim-Through Bolted	<ul style="list-style-type: none"> <li>• Lever always rigid</li> <li>• No latch included</li> <li>• Ideal for pantries &amp; closets</li> </ul> <p>Note: Handing of door for dummy trim only depends on side of door lever trim installed.</p>
	TL3750S*	Half Dummy Trim-Surface Mounted	<ul style="list-style-type: none"> <li>• Lever always rigid</li> <li>• No latch included</li> <li>• Ideal for pantries &amp; closets</li> </ul> <p>Note: Handing of door for dummy trim only depends on side of door lever trim installed.</p>
	TL3770	Full Dummy Trim-Through Bolted	<ul style="list-style-type: none"> <li>• Levers always rigid</li> <li>• No latch included</li> <li>• Ideal for sliding doors</li> </ul> <p>Note: Handing of door for dummy trim only depends on side of door lever trim installed.</p>
	TL3780 TL3780A	Communicating Communicating 3 hour	<ul style="list-style-type: none"> <li>• Blank rose outside</li> <li>• Lever retracts latch</li> <li>• Ideal for adjoining rooms</li> </ul> <p>Note: Hand door from outside of door.</p>

\*Function not available with Inspire™ roseless trim

# Muséo® Trim Designs

## TL3700 Series

### Jackson

Intuitive shapes, moving with the energetic rhythm of modern life.



**105<sup>3</sup>**

Lever: Cast  
Handed - Specify hand  
Non-Reversible

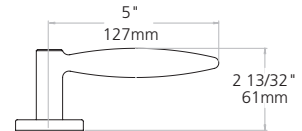

**117<sup>3</sup>**

Lever: Cast  
Non-Handed lever

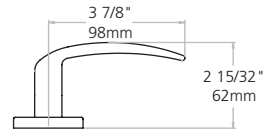

**119<sup>3</sup>**

Lever: Cast  
Handed - Specify hand  
Non-Reversible

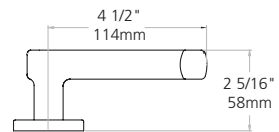

**121<sup>2,3</sup>**

Lever: Cast  
Handed - Specify hand  
Non-Reversible

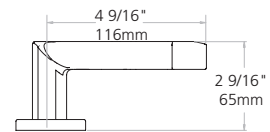

**126<sup>1,3</sup>**

Lever: Cast  
Handed - Specify hand  
Non-Reversible

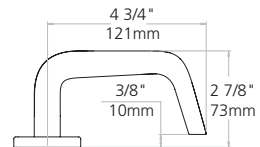

**152**

Lever: Cast  
Handed - Specify hand  
Non-Reversible

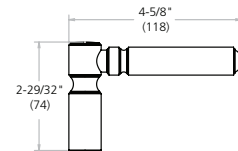

1. Complies with codes requiring lever to return to within 1/2" (13mm) of door face.
2. Not available with Inspire™ roseless trim.
3. Not available in 32D or 32 finish.

# Muséo® Trim Designs

## TL3700 Series

### Salvador

Dreamlike beauty manifested in solid, familiar forms.



**106**  
Lever: Cast  
Non-handed lever

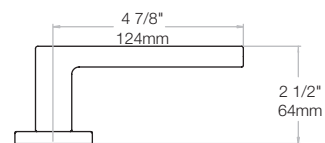

**107**  
Lever: Cast  
Non-handed lever

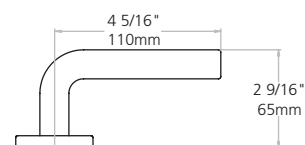

**108**  
Lever: Cast  
Non-handed lever

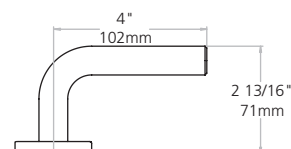

**109<sup>1</sup>**  
Lever: Cast  
Non-Handed lever

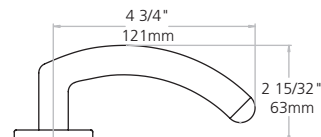

**110**  
Lever: Cast  
Non-handed lever

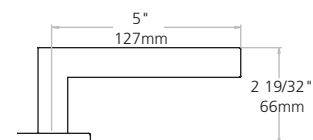

**123<sup>1</sup>**  
Lever: Cast  
Non-handed lever

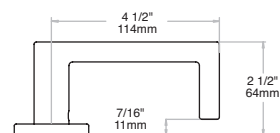

**128<sup>1</sup>**  
Lever: Cast  
Non-handed lever

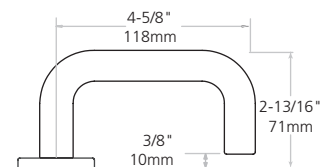

1. Complies with codes requiring lever to return to within 1/2" (13mm) of door face.

# Muséo® Trim Designs

## TL3700 Series

### Marc

Fluid lyricism expressed through whimsical lines and dynamic contours.



**1112<sup>2,3</sup>**

Lever: Cast  
Handed - Specify hand  
Non-Reversible

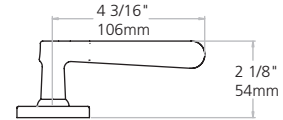

**112<sup>3</sup>**

Lever: Cast  
Handed - Specify hand  
Non-Reversible

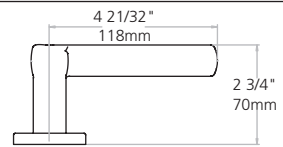

**114<sup>3</sup>**

Lever: Cast  
Handed - Specify hand  
Non-Reversible

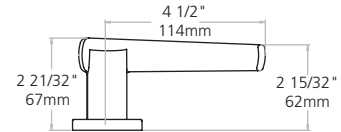

**115<sup>3</sup>**

Lever: Cast  
Handed - Specify hand  
Non-Reversible

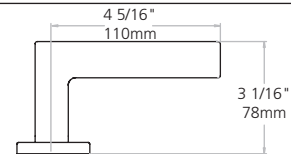

**116<sup>3</sup>**

Lever: Cast  
Handed - Specify hand  
Non-Reversible

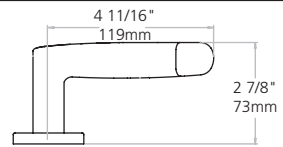

**131<sup>1,3</sup>**

Lever: Cast  
Handed - Specify hand  
Non-Reversible

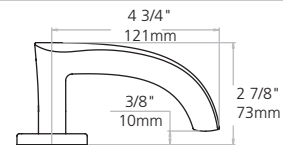

**151**

Lever: Cast  
Handed - Specify hand  
Non-Reversible

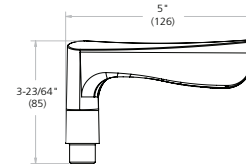

1. Complies with codes requiring lever to return to within 1/2" (13mm) of door face.
2. Not available with Inspire™ roseless trim.
3. Not available in 32D or 32 finish.



# Muséo® Trim Designs

## TL3700 Series

### Georgia

Timeless elegance in forms inspired by the natural world.



**102**  
Lever: Cast  
Non-Handed lever

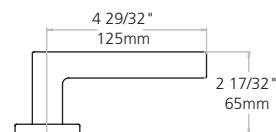

**103**  
Lever: Cast  
Non-Handed lever

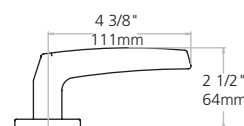

**104<sup>2,3</sup>**  
Lever: Cast  
Non-Handed lever

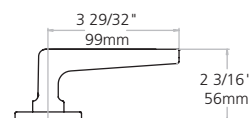

**124<sup>1</sup>**  
Lever: Cast  
Non-Handed lever

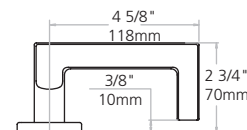

**125<sup>1</sup>**  
Lever: Cast  
Non-Handed lever

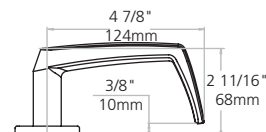

Laser Engraving offered on 102, 103, 124 and 125. See Custom Laser Engraving brochure for details.

1. Complies with codes requiring lever to return to within 1/2" (13mm) of door face.
2. Not available with Inspire™ roseless trim.
3. Not available in 32D or 32 finish.

# Muséo® Trim Designs

## TL3700 Series

### Laszlo<sup>2</sup>

Fine art meets function through crafted lines and flowing curves.



**147**  
Lever: Cast  
Non-Handed lever

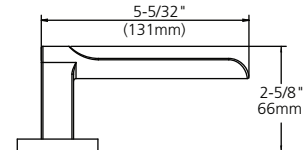

**148<sup>1</sup>**  
Lever: Cast  
Non-Handed lever

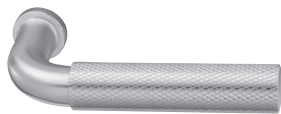
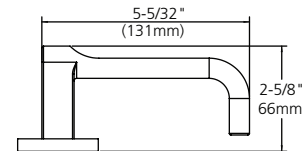

**149**  
Lever: Cast  
Non-Handed lever

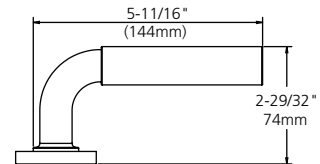

**150**  
Lever: Cast  
Non-Handed lever

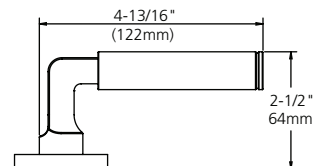

Laser Engraving offered on 102, 103, 124 and 125. See Custom Laser Engraving brochure for details.

1. Complies with codes requiring lever to return to within 1/2" (13mm) of door face.

2. Not available with Inspire™ roseless trim.



# Muséo® Trim Designs

## TL3700 Series

### Josef<sup>2/3</sup>

Tribute to the square with beautifully simple, but equally dramatic forms.



**133**  
Lever: Cast  
Non-Handed lever

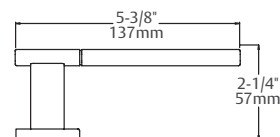

**134<sup>1</sup>**  
Lever: Cast  
Non-Handed lever

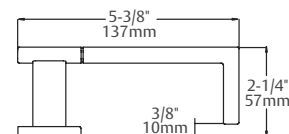

**135**  
Lever: Cast  
Non-Handed lever

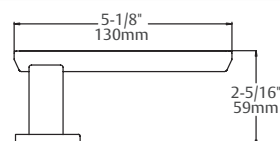

**136**  
Lever: Cast  
Non-Handed lever

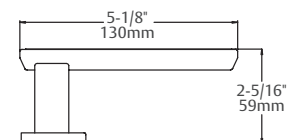

**137<sup>1</sup>**  
Lever: Cast  
Non-Handed lever

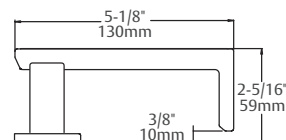

**138<sup>1</sup>**  
Lever: Cast  
Non-Handed lever

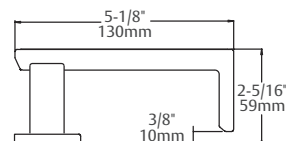

Laser Engraving offered on 133 and 134. See Custom Laser Engraving brochure for details.

1. Complies with codes requiring lever to return to within 1/2" (13mm) of door face.
2. Not available with Inspire™ roseless trim.
3. 135-138 contain white or back polycarbonate insert

# Muséo® Trim Designs

## TL3700 Series

### Georges<sup>2</sup>

Enduring, contemporary pieces that evoke an emotional response with sophisticated design.



**139**  
Lever: Cast  
Non-Handed lever

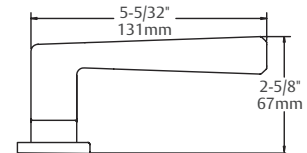

**140<sup>4</sup>**  
Lever: Cast  
Handed lever

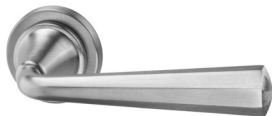
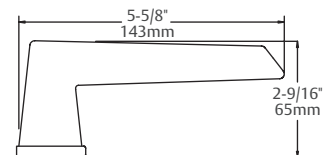

**143<sup>4</sup>**  
Lever: Cast  
Non-Handed lever

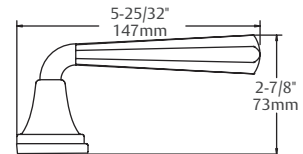

2. Not available with Inspire™ roseless trim.  
4. Not available with TL3720 or TL3720A

# Muséo® Trim Designs

## TL3700 Series

### Piet<sup>2</sup>

Striking levers with sleek, clean lines.



\*Refer to page 15 for how to order the Piet Lever Collection.



#### 21G

Grooved Insert  
Lever: Stainless steel  
Non-Handed Lever

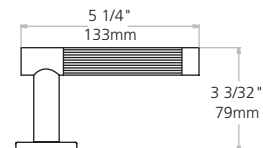

#### 21L

Leather Insert  
Lever: Stainless steel  
Non-Handed Lever

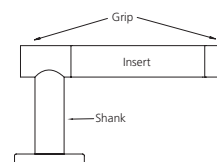

#### 21M

Polished with Satin Insert  
Lever: Stainless steel  
Non-Handed Lever

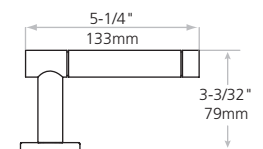

#### 21S

Santoprene™ Insert  
Lever: Stainless steel  
Non-Handed Lever

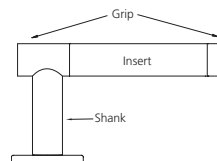

#### 23M

With Raised Band  
Lever: Stainless steel  
Non-Handed Lever

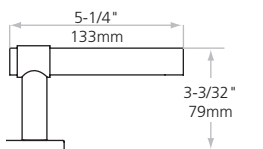

#### 25M

Plain  
Lever: Stainless steel  
Non-Handed Lever

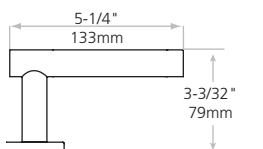

#### 27M

Plain with Two Grooves  
Lever: Stainless steel  
Non-Handed Lever

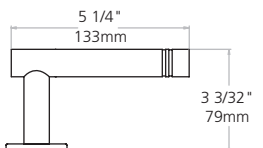

2. Not available with Inspire™ roseless trim.

# Muséo® Trim Designs

## TL3700 Series

### Muséo Roses

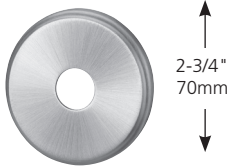

V Rose

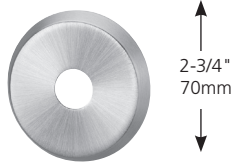

U Rose

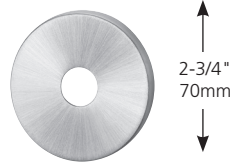

T Rose

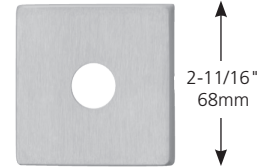

E2 Rose<sup>1</sup>

### Inspire™ Roseless Trim

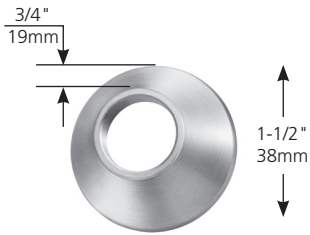

J Collar

Brass or Stainless Steel

### Curved Lip "T" Strike (standard)

- Brass
- 2-3/4" x 1-1/8" x 1-1/4" lip to center
- Optional lip lengths: 1", 1-1/8", 1-3/8", 1-1/2", 1-3/4", 2", 2-1/4", 2-1/2", 2-3/4", 3"
- To order separately, specify 586L19 x Lip Length x Finish

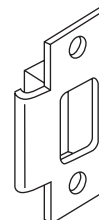

### ANSI Curved Lip

- Brass or stainless steel
- 4-7/8" x 1-1/4" x 1-1/4" lip to center
- Optional lip lengths: 1", 1-1/8", 1-3/8", 1-1/2", 1-3/4", 2", 2-1/4", 2-1/2", 2-3/4", 3"
- To order separately, specify 217L13 x Lip Length x Finish
- To order with lockset, specify quick code found on page 14



### Full Lip Strike

- Brass or stainless steel
- 2-1/4" x 1-3/4" x 1-1/4" lip to center
- No optional lip lengths
- To order with lockset, specify quick code found on page 14
- To order separately specify 680L50M020 x Finish
- Anti-rattle tab

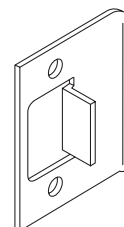

### Full Lip Strike – 1/4" Radius Corners

- Brass or stainless steel
- Similar in dimension and function to L50 strike (above) but with radius corners for easy mortising by power tools
- To order with lockset, specify quick code found on page 14
- To order separately specify 680L51M020 x Finish
- Anti-rattle tab

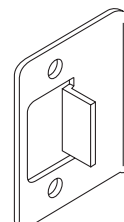

### ANSI Wrought Strike Box

- To order with lockset, specify quick code found on page 14. To order separately, specify 120F768.

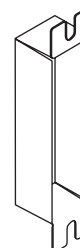

1. Cannot retrofit on existing cylindrical lock door preps with thru-bolt holes outside the 2-1/8" bored hole (Ex. CL3300 & CL3500).

# How to Order/Quick Codes

## TL3700 Series

### Strikes

Lip to Center	ANSI Curved Lip, Specify	T-Strike Curved Lip Box, Specify	Full Lip Specify	Full Lip Radius Corner Specify
1" (25mm)	SA100	SC100	N/A	N/A
1-1/8" (29mm)	SA118	SC118	N/A	N/A
1-1/4" (32mm)	SA114	SC114 (std)	SF114	SFR114
1-3/8" (35mm)	SA138	SC138	N/A	N/A
1-1/2" (38mm)	SA112	SC112*	N/A	N/A
1-3/4" (44mm)	SA134	SC134	N/A	N/A
2" (51mm)	SA200	SC200	N/A	N/A
2-1/4" (57mm)	SA214	SC214	N/A	N/A
2-1/2" (64mm)	SA212	SC212	N/A	N/A
2-3/4" (70mm)	SA234	SC234	N/A	N/A
3" (76mm)	SA300	SC300	N/A	N/A

\*Standard for D214

### Door Thickness

Measurement	Specify
1-3/8" (35mm) up to 1-3/4" (44mm)	D138
1-3/4" (44mm) up to 2" (51mm)	(standard)
2" (51mm) up to 2-1/2" (64mm)	D214
(Consult factory if over 2-1/2" (64mm))	

### Backset

Measurement	Specify
2-3/4" (70mm)	(standard)
2-3/8" (60mm)	B238 <sup>†</sup>

<sup>†</sup>1" front supplied standard

### Ordering Examples

#### TL3700 Series

Quantity	Series/Function	Trim	Finish
25	TL3710	102U	626

### Micellaneous Options

Description	Specify
Rounded corners on latch front	M13
1" (25mm) latch front, square corners	M14**
1" (25mm) latch front, rounded corners	M15
ANSI wrought strike box	M17

\*\*Standard for 2-3/8" backset

### Finishes

Description	Specify
ANSI/BHMA 605 Bright Brass	605
ANSI/BHMA 606 Satin Brass	606
ANSI/BHMA 611 Bright Bronze	611
ANSI/BHMA 612 Satin Bronze	612
ANSI/BHMA 613 Dark Oxidized Satin Bronze, Oil Rubbed	613
613E Dark Oxidized Satin Bronze - equivalent	613E
ANSI/BHMA 613L Dark Oxidized Satin Bronze, Clear Coated	613L
ANSI/BHMA 618 Bright Nickel Plated	618
ANSI/BHMA 619 Satin Nickel Plated	619
ANSI/BHMA 625 Bright Chromium Plated	625
ANSI/BHMA 626 Satin Chromium Plated	626
ANSI/BHMA 629 Bright Stainless Steel	629
ANSI/BHMA 630 Satin Stainless Steel	630
ANSI/BHMA 722 Black Oxidized Bronze, Oil Rubbed	722
— Black Suede Powder Coat	BSP
— White Suede Powder Coat	WSP

NOTE: Piet only offered in stainless steel and BSP finishes only. See page 15 for finish codes.

#### TL3700 Series with Inspire™ Roseless Trim

Quantity	Series/Function	Trim <sup>^</sup>	Finish
25	TL3710	102J	626

<sup>^</sup>Specify J for the rose when ordering Inspire roseless trim.

# How to Order Piet Lever Collection

## TL3700 Series

### Lever Trim and Finish Options



Grooved Insert  
21G



Leather Insert  
21L



Polished with  
Satin Insert  
21M



Santoprene™  
Insert  
21S



With Raised  
Band  
23M



Plain  
25M



Plain with Two  
Grooves  
27M

### Piet Finish Codes

ANSI/BHMA & Corbin Russwin Finish Code	Piet Code*	Description
630	30	Satin Stainless Steel
629	29	Bright Stainless Steel
N/A	BK	Black (Santoprene™ or leather insert)
N/A	BN	Brown (leather insert)
N/A	00	No Insert
613E	E3	Dark Satin Bronze Equivalent
BSP	BS	Black Suede
WSP	WS	White Suede

\*Code used to specify Piet Collection finishes only. Use available finishes list to specify desired finish when ordering.

### Piet Lever Descriptions & Available Finishes

Lever Designation	Lever Description	Available Finishes (as ordered)
21G	Grooved Insert	303030, 292929, 293029, 302930, 3E003E, BP00BP, WS00WS
21L	Leather Insert	30BK30, 30BN30, 29BK29, 29BN29, 3EBK3E, BSBKBS, WSBKWS, 3EBN3E, BSNBNS, WSNBNS
21M	Metallic Insert	293029**
21S	Santoprene Insert	30BK30, 29BK29, 3E003E, BS00BS, WS00WS
23M	Raised Band	290030**, 290029, 300030, 300029***, 3E003E, BS00BS, WS00WS
25M	Plain	290029, 300030, 3E003E, BS00BS, WS00WS
27M	Two Grooves	290029, 300030, 3E003E, BS00BS, WS00WS

\*\*Two-tone finish - grip of lever is 630, balance of lever is 629. Rose and lock finish will be 629.

\*\*\*Two-tone finish - grip of lever is 629, balance of lever is 630. Rose and lock finish will be 630.

### Ordering Examples

Rose Options: T, U, V, E2

Quantity	Series/ Function	Trim	Lever Finish	Lock Finish	Hand
2	TL3710	21LU	29BK29	629	RH
5	TL3710	25MT	290029	629	RH



# Architectural Specifications

## TL3700 Series

### TL3700 Series Tubular Lock

1. Locksets shall be TL3700 Series as manufactured by Corbin Russwin Architectural Hardware, Berlin, CT.
2. Locks shall be non-handed with bi-directional lever operation.
3. Locks shall mount in a standard ANSI/BHMA door prep (2-1/8" dia.) without additional throughbolt preps. (Does not apply to Inspire™ roseless trim)
4. Lockset levers shall be made of solid material with no plastic fillers.
5. Locks shall have a 2-3/4" (70mm) backset standard, with 2-3/8" (60mm) offered as an option.
6. Strikes shall be non-handed with a curved lip.
7. Locks shall have a one year limited warranty.

### TL3700 Series Exploded View

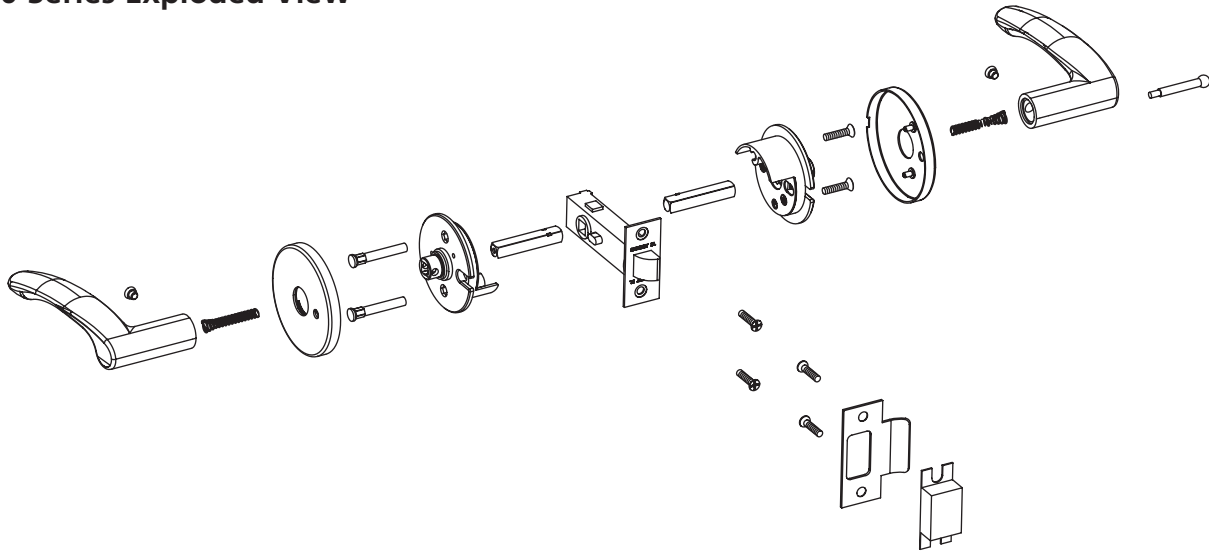

### TL3700 Series with Inspire™ Roseless Trim Exploded View



# Notes

## TL3700 Series

The ASSA ABLOY Group is the global leader in access solutions. Every day, we help billions of people experience a more open world.

ASSA ABLOY Opening Solutions leads the development within door openings and products for access solutions in homes, businesses and institutions. Our offering includes doors, frames, door and window hardware, mechanical and smart locks, access control and service.



For additional information, contact your  
ASSA ABLOY Door Security Solutions  
sales consultant or visit [www.corbinrusswin.com](http://www.corbinrusswin.com).

**In U.S.**

Corbin Russwin  
225 Episcopal Road  
Berlin, CT 06037  
Phone: 800-543-3658  
Fax: 800-447-6714  
[www.corbinrusswin.com](http://www.corbinrusswin.com)

**In Canada**

ASSA ABLOY Door  
Security Solutions Canada  
160 Four Valley Drive  
Vaughan, Ontario  
Canada L4K 4T9  
Phone: 800-461-3007  
Fax: 800-461-8989  
[www.assaabloydss.ca](http://www.assaabloydss.ca)