

200 Class 70mm ClearView™ LED Stacklight™

The 200 Class 70mm ClearView™ LED Stacklight™ is a versatile, multi-mode signaling device that may contain up to five light modules, or four light modules and one sounder module in a single, integrated stack. The lens modules are clear, and are available with red, amber, blue, green, yellow and white LEDs in 24V AC, 24V DC and 120V AC. The lenses are made from a self-extinguishing polycarbonate material and are scratch and impact resistant.

Optional piezoelectric and magnetodynamic sounder modules complement the visual signals of the Stacklight™, offering several audible tones depending on the model chosen. The sound module has been designed so that it is always in the top position of the Stacklight™.

The 200 Class 70mm ClearView™ LED Stacklight™ features an interlocking system for quick assembly without any tools. It is available in gray or black and offers multiple voltage ranges to provide solutions for industrial applications, while also meeting machine builder and OEM requirements.



The clear outer lens with colored LEDs inside are an ideal solution for high ambient light conditions.

200 Class 70mm ClearView™ LED Stacklight™ Features

- cULus Listed
- CE approved
- IP65 or IP54 available
- Clear lens
- LED light source
- Multi-Mode
(Steady, Single, Double or Triple Flash)
- Available in Gray or Black
- Stackable up to five modules including sounder
- Quick and simple assembly with NO tools required
- Two optional sounders available
 - Piezoelectric: Six user selectable tones
 - Magnetodynamic: 32 user selectable tones
- 24V AC, 24V DC and 120V AC

200 Class 70mm Clear-View™ LED Stacklight™

Description	Cat. No.**						Operating Temp.
Wiring Base and Cover - Gray	270BC**						-22°F to 140°F (-30°C to 60°C)

Module Type	Cat. No.**	Operating Voltage†	Current	Current mA (flash)			LED Color	Operating Temp.	Flash Rate
				Single	Double	Triple			
200 Class 70mm Modules - Gray Integrated LED Steady	270CLEDS*24AD	24V DC	0.065A				Amber, Red, Yellow Blue, Green, White	-22°F to 122°F (-30°C to 50°C)	
		24V AC	0.085A				Amber, Red, Yellow Blue, Green, White		
		24V AC	0.075A				Amber, Red, Yellow Blue, Green, White		
	270CLEDS*120A	120V AC/DC	0.035A				Amber, Red, Yellow Blue, Green, White	-22°F to 122°F (-30°C to 50°C)	
200 Class 70mm Modules - Gray Integrated LED Multimode	270CLEDM*24AD	24V AC	0.085A	60	50	50	Amber, Red, Yellow Blue, Green, White	-22°F to 122°F (-30°C to 50°C)	Single - 75 fpm Double - 85 fpm Triple - 85 fpm
		24V AC	0.075A	55	40	45	Amber, Red, Yellow Blue, Green, White		
	24V DC	0.065A	40	40	40	Amber, Red, Yellow Blue, Green, White			
	270CLEDM*120A	120V AC	0.035A	25	20	25	Amber, Red, Yellow Blue, Green, White	-22°F to 122°F (-30°C to 50°C)	
		120V AC	0.035A	25	20	20	Blue, Green, White		
Piezoelectric Acoustic - Gray (IP54)	270PZO1248AD	12V AC/DC	0.003A					-22°F to 140°F (-30°C to 60°C)	
		24V AC/DC	0.006A						
		48V AC/DC	0.013A						
	270PZO120240A	120V AC/DC	0.004A					-22°F to 132.8°F (-30°C to 56°C)	
		240V AC/DC	0.010A						
Magnetodynamic Acoustic - Gray (IP54)	270MDA1224AD							-22°F to 140°F (-30°C to 60°C)	
	270MDA120A						See chart below	-22°F to 122°F (-30°C to 50°C)	
	270MDA240A								

70mm Magnetodynamic (MDA) Acoustic Module

Sound Type	F (Hz)‡	12V DC		24V DC		12V AC		24V AC		120V AC		240V AC	
		A	dB @ 1m	A	dB @ 1m	A	dB @ 1m	A	dB @ 1m	A	dB @ 1m	A	dB @ 1m
Bi-tone	450/540	100	89	120	95.5	0.340	92.5	0.380	97.5	0.055	96	0.035	96.5
	600/700	125	90	150	96.5	0.380	92.5	0.450	99	0.065	96.5	0.035	97.5
	600/700	125	90	145	96.5	0.390	92.5	0.450	99	0.065	96.5	0.035	97.5
	800/970	170	93	190	100	0.485	95	0.550	101	0.075	99	0.040	99.5
	2400/2850	335	97.5	450	106	0.945	100.5	0.1060	107	0.0105	102	0.060	102.5
Bi-tone with pause	600/700	30	89.5	45	96	0.120	92	0.170	98	0.055	96.5	0.030	97.5
	1200/1700	45	95	60	98.5	0.170	97.5	0.230	100.5	0.060	99	0.035	99.5
	2400/2830	70	100	90	104.5	0.210	103	0.295	106	0.085	102	0.045	102
Fast bi-tone	800/970	170	92.5	190	99.5	0.485	94.5	0.555	101	0.075	99	0.040	99.5
Multi-tone	1000/1700	150	95	185	99.5	0.445	98	0.555	101	0.070	98.5	0.040	99
Multi-tone (buzzer)	800/970	110	92.5	140	96.5	0.370	96	0.440	98.5	0.060	97	0.035	97.5
	2400/2830	290	100	335	104	0.755	102.5	0.875	105.5	0.090	101.5	0.050	102
Slow multi-tone	800/970	110	95	140	99	0.350	97.5	0.440	100.5	0.060	99	0.035	100
	2400/2830	290	101	335	105.6	0.720	103.5	0.855	106.5	0.095	103	0.050	103.5
Fast multi-tone	800/970	110	93	140	97.5	0.350	96	0.435	99	0.060	97	0.035	98
	2400/2830	290	100.5	335	104.5	0.725	102.5	0.865	105.5	0.095	102	0.050	102.5
Intermittent multi-tone	500/1200	85	95.5	110	99	0.280	98	0.355	101	0.065	99	0.035	100
Descending multi-tone	1200/500	95	94	125	98	0.315	96.5	0.385	99.5	0.060	98	0.035	98.5
Evacuation	430/560	110	86.5	125	95.5	0.345	89	0.400	97	0.060	95.5	0.035	96
Intermittent	660	45	89.5	65	93.5	0.190	92	0.250	95.5	0.045	94.5	0.025	95
	660	45	90.5	70	94.5	0.190	93	0.240	96.5	0.055	95.5	0.030	95.5
	970	30	92	50	96	0.130	94	0.185	97	0.050	95.5	0.030	96.5
Fast intermittent	2830	200	96.5	240	102	0.600	99.5	0.705	102.5	0.080	98.5	0.045	99
	2850	170	95.5	205	101	0.550	98.5	0.585	102	0.075	98.5	0.040	99
Slow intermittent	660	50	90.5	70	94.5	0.175	93	0.240	96.5	0.055	95.5	0.030	95.5
	970	70	92.5	95	96.5	0.230	94.5	0.295	97.5	0.065	96	0.035	96.5
Linear	300	40	87	60	91	0.170	91	0.220	93	0.040	93	0.025	93
	500	65	89.5	90	93.5	0.235	93.5	0.290	96	0.050	95	0.030	95.5
	1000	125	92	160	96.5	0.385	94	0.485	98	0.065	95.5	0.035	97
	2830	320	97.5	360	102	0.770	100	0.915	103.5	0.095	99	0.055	99.5
Modulated	1000/1700	150	97	185	101.5	0.440	100	0.550	103	0.075	100.5	0.040	101
	1400/1600	165	95	205	99.5	0.470	98	0.595	101.5	0.075	98.5	0.040	98.5







* Letter in this position designates LED color: A - amber, B - blue, G - green, R - red, W - white, or Y - yellow

**NOTE: Add "B" to end of the catalog number for Black unit.

†AC voltage frequency is 50/60 Hz

‡For AC voltages only

70mm Piezoelectric (PZO) Acoustic Module Dip Switch Settings

Sound Type	Diagram	F (Hz) [‡]	12V DC/V AC		24V DC/V AC		48V DC/V AC		120V AC		240V AC	
			A	dB @ 1m	A	dB @ 1m	A	dB @ 1m	A	dB @ 1m	A	dB @ 1m
Continuous reduced output		50/60	0.003	75	0.006	81	0.013	83	0.004	75	0.010	81
Continuous maximum output		50/60	0.003	79	0.006	85	0.013	89	0.004	81	0.010	87
Slow intermittent reduced output		50/60	0.003	72	0.006	77	0.013	79	0.004	76	0.010	78
Slow intermittent maximum output		50/60	0.003	77	0.006	84	0.013	86	0.004	81	0.010	85
Fast intermittent reduced output		50/60	0.003	74	0.006	79	0.013	81	0.004	76	0.010	79
Fast intermittent maximum output		50/60	0.003	78	0.006	85	0.013	87	0.004	81	0.010	85

[‡]For AC voltages only

Accessories

Description	Cat. No.
Junction Box - Gray	270JBX**
Footing with Extension - Gray	270KIT**
Threaded Extension Pole 100mm - Gray	270TEP**
Threaded Footing - Gray	270THF**
Threaded Wall Mount - Gray	270TWM**
Double Threaded Wall Mount - Gray	270TWM2**
270 Flexible Steel Extension Stem - 370mm	270FLXT
270 Stainless Steel Extension Stem - 100mm	270SSXT100
270 Stainless Steel Extension Stem - 200mm	270SSXT200
270 Stainless Steel Extension Stem - 400mm	270SSXT400
270 Female Adapter Base - Gray	270FMLADAPT

****NOTE:** Add "B" to end of the catalog number for Black unit.



Light Module

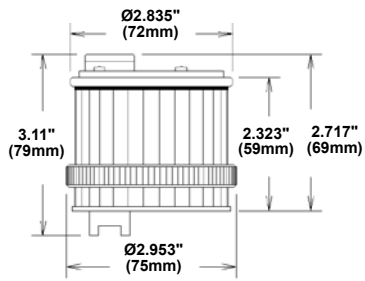

Base and Cover

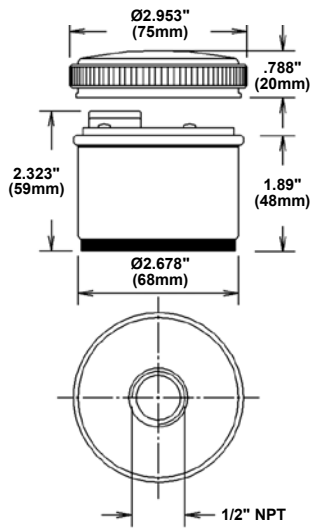

Acoustic Module

