



RAPID Ship Inventory

Reduce Transit Time & Shipping Cost By Location



Satisfaction Guaranteed!

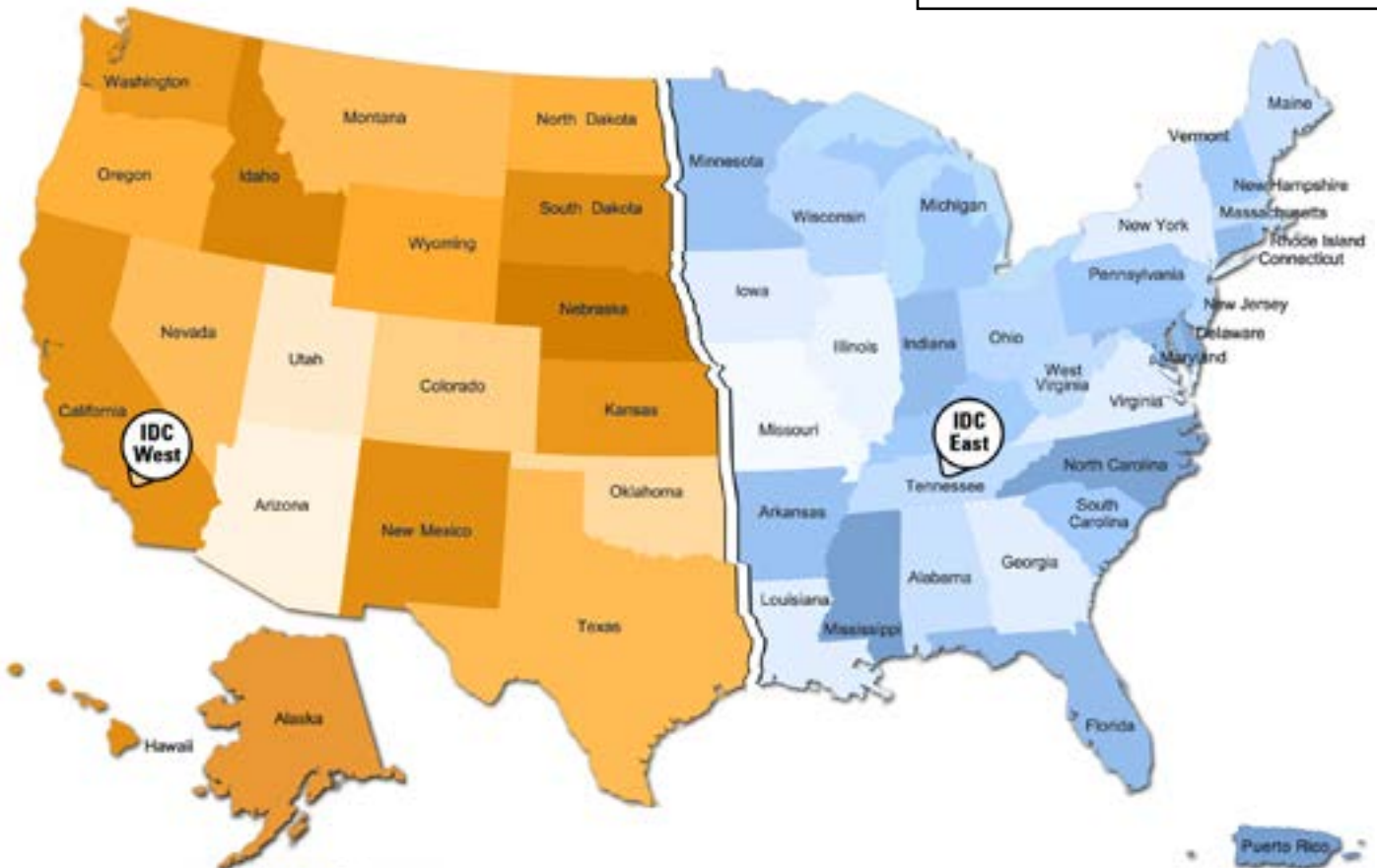

Check Out Our New Concealed Closer!
"D" 200 Series Concealed Closer (Fixed Spring)
With Industry 1st "Back Check" Feature

"Best Quality Closers in the Industry"

*Contact us or go to www.intldoorclosers.com for additional products that are not in our RAPID Ship catalog such as Access Control, Low Energy Operators, Sensors, Custom Hinges and Thresholds.

West: 800-544-4422 • East: 800-225-6737
west@intldoorclosers.com east@intldoorclosers.com

www.intldoorclosers.com

RAPID Ship Inventory



Dear Valued Customer,

It is a privilege to serve your door closer and hardware needs. Our RAPID Ship Brochure will inform you of our many in-house stock items that are readily available to ship from two regional locations.

RAPID Ship Inventory:

- The RAPID Ship items will ship within 24 hours of receiving the purchase order.
- RAPID Ship inventory ships from two regional locations. (Anaheim CA & Nashville TN)
- If your RAPID Ship item is not stocked. We'll cover the shipping upon availability.

Freight Policy:

- Prepaid on 350 pounds or \$1,500.00 whichever comes first, by carrier of our choice within the continental United States. (When customers specifies routing by another carrier or shipping oversized items (70" in length) or longer, any excess charges incurred will be billed).
- Prepaid items include only in house stock (RAPID Ship items). Any outsourced items or oversized hardware are excluded.
- Customers that choose to use "UPS / FedEx "collect" or 3rd party accounts to ship may do so. The shipping account information needs to be available on the original order at the time of order receipt.
- Non-Transportation surcharges {i.e.: construction site delivery, oversized box or pallet, delivery notification, lift gate service, etc.} will be billed to the customer.

Pricing

- All prices are subject to change without notice. State and local taxes, if any, are to be paid by the purchaser.

Returns:

- All returns require an RGA number in order to complete the return.
- A restocking fee of \$25.00 or 15% "whichever is greater" may apply to returned items. (Any outsourced items not within the RAPID Ship catalog such as access control, security products, custom size, thresholds and gasketing will be subject to our suppliers return policies).

Claims:

- Claims for shortages and/or damaged product must be made within 10 days of order entry.

Cancellation:

- Any orders canceled after shipping are subject to shipping charges and / or handling fees.

2021 Update Notification

(COVID-19) update: We are currently open and shipping orders. Please call for will call arrangements, the health and safety of our employees and customers remain our top priority.



West: 800-544-4422 • East: 800-225-6737

west@intldoorclosers.com

east@intldoorclosers.com

www.intldoorclosers.com



CONCEALED CLOSERS

- D200 Series (Grade 1) 1, 2
- D200-SA Series 3, 4
- D300 Series (Grade 2) 5, 6
- D500 Series (Grade 1) 7, 8
- Concealed Closers Cross Reference Chart 9, 10

SURFACE CLOSERS

- 44CI Series (Grade 1) 11, 12
- 850 & 880 Series 13, 14
- 1800 Series (Grade 1) 15, 16
- 5000-TP Series (Grade 1) 17, 18
- 8000-TP Series (Grade 1) 19, 20
- 9000-TP Series (Grade 1) 21, 22
- Surface Closers Cross Reference Chart 23, 24

DOOR HARDWARE

- Deadlocks and Deadlatches 25, 26
- Paddle Handle, Cam Plug and Lever Handle 27
- Flushbolts and Coordinators 28
- Threshold Bolts 29
- Mortise and Rim Cylinders, Thumbturns & Lock Indicator 30
- Door Pulls & Push Bars 31
- Door Holder Stops 32

PIVOTS

- Pivots 33, 34
- Jackson-Somaca-CRL Pivot Crossover Reference Chart 35
- SS Center Hung Pivots 36

HINGES

- Continuous Hinges 37-40
- Continuous Geared Hinge Cross Reference Chart 40

EXIT DEVICES

- 5000 Series (Grade 2) 41-46
- 7100 Series 47
- 7300 Series 48
- 8000 Series (Grade 1) 48-56

ARCHITECTURAL HARDWARE FINISHES

- Finishes 54





5 YEAR WARRANTY
[Click Here For Info.](#)

OVERHEAD CONCEALED CLOSER **D200 SERIES**



FEATURES

- **I.D.C. provides LEAK-FREE guaranteed performance** under the most demanding conditions.
 1. Steel spring cap is now on top of closer body utilizing a new high performance O-Ring and epoxy sealed threads for double protection.
 2. New automotive type heavy duty spindle seal replacing old standard O-ring technology.
 3. All three adjustment valves now with two high performance O-rings for double protection.
 4. Steel end caps incorporating new high performance O-rings and also epoxy sealed threads for double protection.
 5. Adjustable back check after 80° to prevent the door from slamming open.
- **CENTER HUNG DOORS:** Double or Single Acting (Door stop applied to frame renders unit Single Acting). Adjustable "S" type side loading or "A" type, "K" type and "PT" type end loading top arms are available for center pivoted applications.
- Built-in positive back stop and hold-open positions available:
 - 105° Back Stop with Hold-Open
 - 105° Back Stop - no Hold-Open
 - 90° Back Stop with Hold-Open
 - 90° Back Stop - no Hold-Open
- ADA spring tensions available for use on center pivoted applications:
 - 5 lb. opening force (Interior door)
 - 8-1/2 lb. opening force (Exterior door)
- Standard spring tensions available:
 - **LIGHT, MEDIUM & HEAVY**
- Three control valves: Closing speed, latching speed and back check, fully adjustable after installation.
- Fits in an aluminum header or transom bar as small as 1-3/4" x 4".
- Positive centering for alignment and to hold door closed against any normal wind or draft.
- Stable hydraulic door check fluid for any climatic operation and constant lubrication.

NEW IMPROVED FEATURES



1) Steel spring cap is now on top of closer body utilizing a new high performance O-Ring and epoxy sealed threads for double protection.



2) New automotive type heavy duty spindle seal replacing old standard O-ring technology.



3) All three adjustment valves now with two high performance O-rings for double protection.

4) Now with steel end caps incorporating new high performance O-rings and epoxy sealed threads for double protection.

5) Adjustable back check after 80° to prevent the door from slamming open.

Center Hung Doors: Complete units for aluminum doors and frames are furnished with top arm assembly (adjustable 'S' side loading, "A" end loading, "K" end loading or "PT" end loading), adjustable dual purpose 3010-DP bottom pivot set for floor or threshold mounting (side or end loading) and 3010-FS anchor set with all fasteners. 3010-G and 3010-GE bottom pivot sets are available, but must be ordered separately.



"S" type side loading top arms and 3010-DP adjustable dual purpose pivot set and 3010-FS anchor set will be furnished unless otherwise specified.



















"A" type, "K" type or "PT" type end loading and "JO" or "VO" type offset arms are optional, but must be specified.

"G" and "GE" type pivot sets are available, but must be ordered separately.

Offset Hung Doors: Single Acting. Offset "JO" and "VO" type top arms are available for butt hinge or offset pivot applications.

(Offset Pivots or Butt Hinges not included. Top Door Stop/ Arm Cover by others – fabrication drawings available.)

D200 SERIES	DOOR SIZE	SPRING TENSION	TYPE	MODEL WITH "S" "A" "K" OR "PT" ARM	MODEL WITH "JO" OR "VO" OFFSET ARM
<p>NOTE: Doors of sizes over the schedule, or of excessive weight, or doors subject to severe wind or draft conditions, or abusive usage, require the next stronger model closer.</p> <p>SPECIFY: Closer Model Number and Type of Top Arm, Anchor and/or Pivot Set.</p> <p>SPECIFY FINISH: For 3010-JO or 3020-VO Arms AL - Satin Aluminum DU - Storefront Bronze</p> <p>WARRANTY: 5 Year Warranty</p>	From 36" to 48" X 96"	ADA 5lb. (INTERIOR) 	105° Back Stop with Hold-Open 105° Back Stop - no Hold-Open 90° Back Stop with Hold-Open 90° Back Stop - no Hold-Open	D200 D201 D202 D203	NA NA NA NA
	From 36" to 48" X 96"	ADA 8-1/2lb. (EXTERIOR) 	105° Back Stop with Hold-Open 105° Back Stop - no Hold-Open 90° Back Stop with Hold-Open 90° Back Stop - no Hold-Open	D210 D211 D212 D213	NA NA NA NA
	Up to 30" X 96"	LIGHT	105° Back Stop with Hold-Open 105° Back Stop - no Hold-Open 90° Back Stop with Hold-Open 90° Back Stop - no Hold-Open	D220 D221 D222 D223	D220 X JO or VO D221 X JO or VO D222 X JO or VO D223 X JO or VO
	31" to 41" X 96"	MEDIUM	105° Back Stop with Hold-Open 105° Back Stop - no Hold-Open 90° Back Stop with Hold-Open 90° Back Stop - no Hold-Open	D230 D231 D232 D233	D230 X JO or VO D231 X JO or VO D232 X JO or VO D233 X JO or VO
	42" to 48" X 96"	HEAVY	105° Back Stop with Hold-Open 105° Back Stop - no Hold-Open 90° Back Stop with Hold-Open 90° Back Stop - no Hold-Open	D240 D241 D242 D243	D240 X JO or VO D241 X JO or VO D242 X JO or VO D243 X JO or VO

D200 SERIES PARTS AND ACCESSORIES			PART NO.
	Unit Body (Specify: Spring Tension & degree of Back Stop & Hold open)		D2000-B
		"S" Type Adjustable Side Loading Top Arm Assembly (1/2" Depth Top Rail)	3010-S
		"A" Type End Loading Top Arm Assembly (1" Depth Top Rail)	3010-A
		"K" Type End Loading Top Arm Assembly (5/8" Depth Top Rail)	3010-K
		"PT" Type End Loading Top Arm Assembly (7/8" Depth Top Rail)	3010-PT
		"JO" Type Offset Top Arm Assembly Mortised Type (9/16" Depth Top Rail)	Painted Arm -Aluminum Storefront Bronze 3010-JO x AL 3010-JO x DU
* JO and VO type offset arm in lieu of S, A, K & PT type arms ADA opening force may not provide sufficient power to reliably close and latch a door			
		"VO" Type Offset Top Arm Assembly Surface Type (7/8" Depth Top Rail)	Painted Arm -Aluminum Storefront Bronze 3020-VO x AL 3020-VO x DU
	Anchor Set (Standard)		3010-FS
	Adjustable Dual Purpose Bottom Pivot Set (Standard)		3010-DP
	Adjustable Floor Mount Bottom Pivot Set (Optional)		3010-G
	Adjustable Threshold Mount Bottom Pivot Set (Optional)		3010-GE
	Dummy Closer, Standard Spindle Without Oil & Spring, 12mm Spindle, 3010FS Anchor Set Dummy Closer, Long Spindle Body Without Oil & Spring, 19mm Spindle, 3010FS Anchor Set		D2000-B--PIVOT D2000-B-PIVOT-LS

*in lieu of S, A, K, or PT arms.



ALL GLASS DOOR CONCEALED CLOSER

D200-SA SERIES

HANDICAP & STANDARD



5 YEAR WARRANTY

[Click Here For Info.](#)

FEATURES

- I.D.C. provides **LEAK-FREE guaranteed performance** under the most demanding conditions.
 1. Steel spring cap is now on top of closer body utilizing a new high performance O-Ring and epoxy sealed threads for double protection.
 2. New automotive type heavy duty spindle seal replacing old standard O-ring technology.
 3. All three adjustment valves now with two high performance O-rings for double protection.
 4. Steel end caps incorporating new high performance O-rings and also epoxy sealed threads for double protection.
 5. Adjustable back check after 80° to prevent the door from slamming open.
- **CENTER HUNG DOORS:** Double or Single Acting Door (Door stop applied to frame renders unit Single Acting). "A" type short end loading top arm supplied for smaller top rail applications.
- 3/4" spindle length for better door support.
- Built in positive back stop and hold-open positions available:
 - 105° Back Stop with Hold-Open
 - 105° Back Stop - no Hold-Open
 - 90° Back Stop with Hold-Open
 - 90° Back Stop - no Hold-Open
- Standard spring tensions available:
 - **MEDIUM, HEAVY**
- Three control valves: Closing speed, latching speed and back check, fully adjustable after installation.
- Adjustable 3010-DP dual purpose radial ball-bearing bottom pivot set is provided for floor or threshold mounted (end loading) center pivoted installation.
- Cast Iron Body fits in aluminum header or transom bar as small as 1-3/4" x 4".
- Positive centering for alignment and to hold door closed against any normal wind or draft.
- Stable hydraulic door check fluid for any climatic operation and constant lubrication.
- 5-3/4" Short "A" Arm (measured from center line of spindle to end of arm).

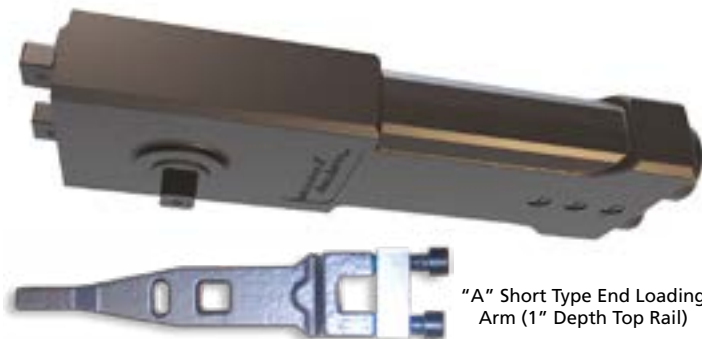

"A" Short Type End Loading Arm (1" Depth Top Rail)

NEW IMPROVED FEATURES



(1)

(2)

(3,4,5)

Center Hung Doors: Complete units for aluminum doors and frames are furnished with top arm assembly (adjustable 'S' side loading, "A" end loading, "K" end loading or "PT" end loading), adjustable dual purpose 3010-DP bottom pivot set for floor or threshold mounting (side or end loading) and 3010-F5 anchor set with all fasteners.

"S" type side loading top arms and 3010-DP adjustable dual purpose pivot set and 3010-F5 anchor set will be furnished unless otherwise specified.

"A" type, "K" type or "PT" type end loading and "JO" or "VO" type offset arms are optional, but must be specified.

"G" and "GE" type pivot sets are available, but must be ordered separately.



Offset Hung Doors: Complete units for offset pivoted or butt hinged aluminum doors and frames are furnished with a "JO" or "VO" type offset arm and 3010-F5 anchor set with all fasteners.

(Offset Pivots or Butt Hinges not included. Top Door Stop/ Arm Cover by others – fabrication drawings available.)

International Door Closers, Inc.

COPYRIGHT 2021 INTERNATIONAL DOOR CLOSERS, INC

D200-SA SERIES	DOOR SIZE	SPRING TENSION	TYPE	MODEL
	31" to 41"	MEDIUM	105° Back Stop with Hold-Open 105° Back Stop - no Hold-Open 90° Back Stop with Hold-Open 90° Back Stop - no Hold-Open	D230-SA D231-SA D232-SA D233-SA
	42" to 48"	HEAVY	105° Back Stop with Hold-Open 105° Back Stop - no Hold-Open 90° Back Stop with Hold-Open 90° Back Stop - no Hold-Open	D240-SA D241-SA D242-SA D243-SA
Note: Sizes may vary due to door weight, stack pressure in the building, and wind conditions.				

D200-SA SERIES PARTS AND ACCESSORIES		PART NO.
	Body Only or Unit Body Specify: Spring Tension and degree of Back Stop and Hold Open	D2000-B-31
	"A" Short Type End Loading Arm (1" Depth Top Rail)	3010-SA
	Adjustable Dual Purpose Bottom Pivot Set	3010-DP
	Anchor Set	3010-FS



ADJUSTABLE SPRING POWER - OVERHEAD CONCEALED CLOSER

D300 SERIES

GRADE 2



5 YEAR WARRANTY

[Click Here For Info.](#)

FEATURES

- I.D.C. provides **LEAK-FREE guaranteed performance** under the most demanding conditions.
 1. Steel spring cap is now on top of closer body utilizing a new high performance O-Ring and epoxy sealed threads for double protection.
 2. New automotive type heavy duty spindle seal replacing old standard O-ring technology.
 3. Adjustment valves now with two high performance O-rings for double protection.
 4. Steel end caps incorporating new high performance O-rings and also epoxy sealed threads for double protection.
- **ADA** closer with Adjustable Spring Power for a range of sizes from 5 lb. to 8.5 lb. **LIGHT, MEDIUM & HEAVY**. Spring Tension, fully adjustable after installation.
- Barrier Free Operation to comply with Federal Accessibility Standards (ADA): complying with ANSI A117.1 (4.13.11) available for center pivoted applications.
- Built-in positive back stop and hold-open positions available:
 - 105° Back Stop with Hold-Open
 - 105° Back Stop - no Hold-Open
 - 90° Back Stop with Hold-Open
 - 90° Back Stop - no Hold-Open
- Suitable for both Center Hung (Double or Single Acting) and Offset Doors.
- Two control valves: Closing speed and latching speed, fully adjustable after installation.
- Fits in an aluminum header or transom bar as small as 1 3/4" x 4".
- Stable hydraulic door check fluid for any climatic operation and constant lubrication.
- Optional 3/4" Spindle Available.



NEW IMPROVED FEATURES



(1)



(2)



(3,4)

Center Hung Doors: Complete units for aluminum doors and frames are furnished with top arm assembly (adjustable 'S' side loading, "A" end loading, "K" end loading or "PT" end loading), adjustable dual purpose 3010-DP bottom pivot set for floor or threshold mounting (side or end loading) and 3010-FS anchor set with all fasteners.

"S" type side loading, "A" type, "K" type, or "PT" type end loading top arms are available for center pivoted applications.

"A" type, "K" type or "PT" type end loading and "JO" or "VO" type offset arms are optional, but must be specified.

"G" and "GE" type pivot sets are available, but must be ordered separately.

















Offset Hung Doors: Complete units for offset pivoted or butt hinged aluminum doors and frames are furnished with a "JO" or "VO" type offset arm (may not meet handicap force requirements) and 3010-FS anchor set with all fasteners .

3010-DP dual purpose radial ball bearing bottom pivot set is standard for floor or threshold center pivoted installation. Optional 3010-GE bottom pivot sets are available, but must be ordered separately.

International Door Closers, Inc.

COPYRIGHT 2021 INTERNATIONAL DOOR CLOSERS, INC

D300 SERIES	TYPE	MODEL NO.
<p>NOTE: Doors of varying sizes, or of excessive weight, or doors subject to severe wind or draft conditions, or abusive usage, refer to Series D200 Overhead Concealed Closers.</p> <p>SPECIFY: Closer Model Number and Type of Top Arm, Anchor and/or Pivot Set.</p> <p>SPECIFY FINISH: For 3010-JO or 3020-VO Arms AL - Satin Aluminum DU - Storefront Bronze</p>	105° Back Stop with Hold-Open	D310
	105° Back Stop - no Hold-Open	D311
	90° Back Stop with Hold-Open	D312
	90° Back Stop - no Hold-Open	D313
	3/4" SPINDLE	MODEL NO.
	105° Back Stop with Hold-Open	D310-20-A-DP
	105° Back Stop - no Hold-Open	D311-20-A-DP

D300 SERIES PARTS AND ACCESSORIES			PART NO.
	Unit Body (Specify: Spring Tension & degree of Back Stop & Hold open)		D3000-B
		"S" Type Adjustable Side Loading Top Arm Assembly (1/2" Depth Top Rail)	3010-S
		"A" Type End Loading Top Arm Assembly (1" Depth Top Rail)	3010-A
		"K" Type End Loading Top Arm Assembly (5/8" Depth Top Rail)	3010-K
		"PT" Type End Loading Top Arm Assembly (7/8" Depth Top Rail)	3010-PT
		"JO" Type Offset Top Arm Assembly Mortised Type (9/16" Depth Top Rail)	Painted Arm -Aluminum Storefront Bronze 3010-JO x AL 3010-JO x DU
<p>* JO and VO type offset arm in lieu of S, A, K & PT type arms ADA opening force may not provide sufficient power to reliably close and latch a door</p>			
		"VO" Type Offset Top Arm Assembly Surface Type (7/8" Depth Top Rail)	Painted Arm -Aluminum Storefront Bronze 3020-VO x AL 3020-VO x DU
	Anchor Set (Standard)		3010-FSP
	Adjustable Dual Purpose Bottom Pivot Set (Standard)		3010-DP
	Adjustable Floor Mount Bottom Pivot Set (Optional)		3010-G
	Adjustable Threshold Mount Bottom Pivot Set (Optional)		3010-GE

*in lieu of S, A, K, or PT arms.



ADJUSTABLE SPRING POWER - OVERHEAD CONCEALED CLOSER

D500 SERIES

GRADE 1



5 YEAR WARRANTY

[Click Here For Info.](#)



5 YEAR WARRANTY

CERTIFIED GRADE 1
ANSI 156.4

FEATURES

- I.D.C. provides **LEAK-FREE guaranteed performance** under the most demanding conditions.
 1. Steel spring cap is now on top of closer body utilizing a new high performance O-Ring and epoxy sealed threads for double protection.
 2. New automotive type heavy duty spindle seal replacing old standard O-ring technology.
 3. All three adjustment valves now with two high performance O-rings for double protection.
 4. Steel end caps incorporating new high performance O-rings and also epoxy sealed threads for double protection.
- **Certified ANSI 156.4 Grade 1**
- **ADA** closer with Adjustable Spring Power for a range of sizes from 5 lb. to 8.5 lb. **LIGHT, MEDIUM & HEAVY.** Spring Tension, fully adjustable after installation.
- Barrier Free Operation to comply with Federal Accessibility Standards (ADA): complying with ANSI A117.1 (4.13.11) available for center pivoted applications.
- Built-in positive back stop and hold-open positions available:
 - 105° Back Stop with Hold-Open
 - 105° Back Stop - no Hold-Open
 - 90° Back Stop with Hold-Open
 - 90° Back Stop - no Hold-Open
- Suitable for both Center Hung (Double or Single Acting) and Offset Doors.
- Two control valves: Closing speed and latching speed, fully adjustable after installation.
- Fits in an aluminum header or transom bar as small as 1 3/4" x 4".
- Stable hydraulic door check fluid for any climatic operation and constant lubrication.
- Optional 3/4" Spindle Available.



NEW IMPROVED FEATURES



(1)



(2)



(3,4)

Center Hung Doors: Complete units for aluminum doors and frames are furnished with top arm assembly (adjustable 'S' side loading, "A" end loading, "K" end loading or "PT" end loading), adjustable dual purpose 3010-DP bottom pivot set for floor or threshold mounting (side or end loading) and 3010-FS anchor set with all fasteners.

"S" type side loading, "A" type, "K" type, or "PT" type end loading top arms are available for center pivoted applications.

"A" type, "K" type or "PT" type end loading and "JO" or "VO" type offset arms are optional, but must be specified.

"G" and "GE" type pivot sets are available, but must be ordered separately.











Offset Hung Doors: Complete units for offset pivoted or butt hinged aluminum doors and frames are furnished with a "JO" or "VO" type offset arm (may not meet handicap force requirements) and 3010-FS anchor set with all fasteners.

3010-DP dual purpose radial ball bearing bottom pivot set is standard for floor or threshold center pivoted installation. Optional 3010-GE bottom pivot sets

International Door Closers, Inc.

COPYRIGHT 2021 INTERNATIONAL DOOR CLOSERS, INC

D500 SERIES	TYPE	MODEL NO.
NOTE: Doors of varying sizes, or of excessive weight, or doors subject to severe wind or draft conditions, or abusive usage, refer to Series D200 Overhead Concealed Closers.	105° Back Stop with Hold-Open	D510
	105° Back Stop - no Hold-Open	D511
	90° Back Stop with Hold-Open	D512
	90° Back Stop - no Hold-Open	D513
SPECIFY: Closer Model Number and Type of Top Arm, Anchor and/or Pivot Set.	3/4" SPINDLE	MODEL NO.
	105° Back Stop with Hold-Open	D510-20-A-DP
SPECIFY FINISH: For 3010-JO or 3020-VO Arms AL - Satin Aluminum DU - Storefront Bronze	105° Back Stop - no Hold-Open	D511-20-A-DP

D500 SERIES PARTS AND ACCESSORIES			PART NO.
	Unit Body (Specify: Spring Tension & degree of Back Stop & Hold open)		D5000-B
	"S" Type Adjustable Side Loading Top Arm Assembly (1/2" Depth Top Rail)		3010-S
	"A" Type End Loading Top Arm Assembly (1" Depth Top Rail)		3010-A
	"K" Type End Loading Top Arm Assembly (5/8" Depth Top Rail)		3010-K
	"PT" Type End Loading Top Arm Assembly (7/8" Depth Top Rail)		3010-PT
	"JO" Type Offset Top Arm Assembly Mortised Type (9/16" Depth Top Rail)	Painted Arm -Aluminum Storefront Bronze	3010-JO x AL 3010-JO x DU
* JO and VO type offset arm in lieu of S, A, K & PT type arms ADA opening force may not provide sufficient power to reliably close and latch a door			
	"VO" Type Offset Top Arm Assembly Surface Type (7/8" Depth Top Rail)	Painted Arm -Aluminum Storefront Bronze	3020-VO x AL 3020-VO x DU
	Anchor Set (Standard)		3010-FSP
	Adjustable Dual Purpose Bottom Pivot Set (Standard)		3010-DP
	Adjustable Floor Mount Bottom Pivot Set (Optional)		3010-G
	Adjustable Threshold Mount Bottom Pivot Set (Optional)		3010-GE

*in lieu of S, A, K, or PT arms.



CROSS REFERENCE CHART

OVERHEAD CONCEALED CLOSERS

D200 SERIES CROSS REFERENCE CHART										
IDC	CRL	Jackson	Calibre	Global	Dor-O-Matic	Sentinel	S. Parker	Taco (TA)	Rixson	Dorma
D200B ~ D203B	CRL6800	USE 20101M (17-20)	2200B ~ 2203B							RTS88BF1
D210A ~ D213A	CRL8900A		2210A ~ 2213A							
D210B ~ D213B	CRL6900	USE 20101M (17-20)	2210B ~ 2213B							RTS88BFE
D210S ~ D213S	CRL8900S		2210S ~ 2213S							
D210GE ~ D213GE	CRL8900GE		2210GE ~ 2213GE							
D220B ~ D223B	CRL7000	2010M (05-08)	1100B ~ 2200B	TC7020 ~ TC7023	USE OHC101	S30	402	32	608-LAP	RTS88
D230A ~ D233A	CRL8100A	21101AE (01-04)	2230A ~ 2233A							
D230B ~ D233B	CRL7100	2010M (01-04)	2230 ~ 2233	TC7030 ~ TC7033	USE OHC100	S30	403	32	608-LAP	RTS88-SZ3
D230S ~ D233S	CRL8100S		2230S ~ 2233S							
D230GE ~ D233GE	CRL8100GE	21101GE	2230GE ~ 2233GE							
D240B ~ D243B	CRL7200	20104M (09-12)	2240-2243	TC7040 ~ TC7043	USE OHC100	S30	404	32	608-LAP	RTS88-SZ4

CAUTION: Closers listed may represent a series. The exact model may include size or function designation

D200-SA SERIES CROSS REFERENCE CHART				
IDC	CRL	Jackson	Calibre	Rixson
D230SA-D233SA	CRL9100	20104M (01-04)	1100-20B ~ 2200-20B	608EXT-LAP
D240SA-D243SA	CRL9200	20104M (01-04)	1140-20B ~ 2240-20B	

CAUTION: Closers listed may represent a series. The exact model may include size or function designation

D300 SERIES CROSS REFERENCE CHART						
IDC	CRL	Jackson	Calibre	AHT	Global	Dor-O-Matic
D310A-D313A	CRL8700A	21101AE (17-20)	3210A ~ 3213A			
D310B-D313B	CRL6700		3301B ~ 3303B	AHT50B5		
D310S-D313S	CRL8700S		3210S ~ 3213S	AHT50S	TC7010ADA	OHC101
D310GE-D313GE	CRL8700GE	21101GE (17-20)	3210GE ~ 3213GE			

CAUTION: Closers listed may represent a series. The exact model may include size or function designation

D500 SERIES CROSS REFERENCE CHART		
IDC	Jackson	
D500B	20111M (05-08)	
	20111M (01-04)	
	20111M (09-12)	

CAUTION: Closers listed may represent a series. The exact model may include size or function designation

PARTS COMPARISON CHART									
IDC	CRL	Jackson	Calibre	Global	Dor-O-Matic	Sentinel	Taco (TA)	Rixson	Dorma
3010-FS	CRL89010FS	20219	CA3010-FS	CLIP	OHC100-FB		MC-32-FS	608019	
3010-FA	CRL8010FA		CA3010-FA				MC-32-FA		
3010-FK	CRL8010FK		CA3010-FK						
3010-S	CRL8010S	20400B	CA3010-S	SLA	OHC100-SL	SLA	A-32-S	608005S	8831
3010-A	CRL8010A	202000	CA3010-A	ELA	OHC100-EL	ELA	A-32-A		8835
3010-PT	CRL8010PT	202010	CA3010-PT				A-32-PT		8836
3010-K	CRL8010K	202085	CA3010-K	KRM		K-ELA	A-32-K		8837
3010-SA	CRL8010AS		CA3010-A-MOD						8836S
3010-JO	CRL8010JO	20900	CA3010-JO	OFFSET ARM			A-32-JO		8812
3010-VO	CRL8020VO	20900	CA3010-VO		OHC100-VO				
3010-DP	CRL8010DP	201680	CA3010-DP	OHC-PIVOT	OHC100-DP		P-32-DP	608011A	
3010-G	CRL8010G	20902	CA3010-G				P-32-G		
3010-GE	CRL8010GE	20944	CA3010-GE	GE-PIVOT	OHC100-GE		P-32-GE		

CAUTION: Closers listed may represent a series. The exact model may include size or function designation



ADJUSTABLE SPRING POWER SURFACE APPLIED GRADE 1 CLOSER

44CI SERIES

HEAVY DUTY CAST IRON



5 YEAR WARRANTY

[Click Here For Info.](#)



FEATURES

- Application for HIGH TRAFFIC Doors
- Cast Iron Body; Forged Steel Arm
- Double Heat Treated Steel Pinion
- All Weather Fluid
- Non-Handed
- Non-Sized Adjustable 1 Through 6; Standard with Back Check
- Universal Application for Regular Arm, Top Jamb, or Parallel Arm Mounting
- Standard Plastic Cover - Non Handed
- Hold-open arms are adjustable for holding from 85° to 180°.
- 5 YEAR WARRANTY

TECHNICAL DIMENSIONS

Description	Dimensions
A. Length of Closer Body (With Cover)	12-1/4"
B. Horizontal Mounting Holes	SEE DRAWING
C. Vertical Mounting Holes	2-1/4"
D. Overall Height	4-7/8"
E. Top of Door to Bottom of Closer	3-11/16"
F. Closer Body Height	3-1/2"
G. Projection from Door	2-1/4"

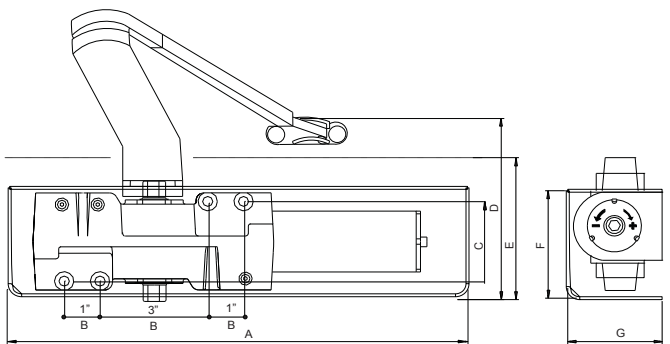

Front View

End View

OPTIONS AVAILABLE

- Metal Cover
- Heavy Duty Arm (EDA)
- Hold-Open arm
- Stop Only Arm
- Friction Hold Open Arm

FINISHES

- AL - Aluminum
- DU - Storefront Bronze

5 YEAR WARRANTY

(Other finishes available by Special Order)

44CI Series Comparison Footprint Chart (5" x 2-1/4")

Advantage 8000	Arrow DC500	C.R. Laurance PR90	Cal Royal CR441	Calibre 4001
Cooper Creek/Bulldog CL8844	Deltana DC40	Design Hardware 416	EZ-Set DO 4	General Lock C9000
Global (Imperial USA) TC4300	Hager 5100	Harney Hardware DC8400	Independace2 4040	Inox/Unison Hardware DC90
Lawrence Hardware LH8016	LCN 4040XP, 4041	LSDA DC6816	Marshall Best QDC-40	MaxGrade MDC100
Norton 410, 9540	Pamex GC4400	PDQ 7100	PLS DC1916	S. Parker 441BC
Seco-Larm SD-C101-SBBQ	Sentinel 4016	Stanley/K2 QDC100	Taymor 4000	Tell 900
Townsteel TDC40	Yale 5800			

International Door Closers, Inc.

COPYRIGHT 2021 INTERNATIONAL DOOR CLOSERS, INC

INSTALLATION TYPES

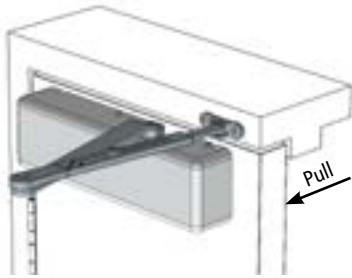





Regular Arm (Pull Side)
Permits 120° maximum opening



Top Jamb (Push Side)
Permits 120° maximum opening



Parallel Arm (Push Side)
Permits 180° maximum opening

44CI SERIES PARTS AND ACCESSORIES		PART NO.
	Plastic Dress Cover	DC-44
	Metal Dress Cover (special order)	DC-44M
	Complete Arm Assembly	44-2021
	Cushion - Hold-open arm - Mechanical Turn Type	44-2022
	Cushion Stop Arm	44-2023
	Friction Hold Open Arm	44-2024
	Heavy Duty Arm (EDA)	44-2026
	Parallel Bracket	425
	Drop Plate for Pull Side installation when top Door Rail is less than 3-3/4". Requires a 2" minimum height Door Rail.	44-18
	Drop Plate for Top Jamb installation when ceiling is flush to top of Header. Requires a minimum 1-3/4" header height.	44-18G
	Drop Plate for Top Jamb installation on Door Headers less than 3-1/2" in height.	44-18J
	Drop Plate for Parallel Arm installation on Door Rails less than 5-1/2" (measured down from the door stop). Requires a 2" minimum height Door Rail.	44-18PA

*in lieu of standard

SPECIFY FINISH:

- AL - Aluminum
- DU - Storefront Bronze

West: 800-544-4422 • East: 800-225-6737
www.intldoorclosers.com



GRADE 2 SURFACE APPLIED CLOSER

850 SERIES

STANDARD

880 SERIES

ADJUSTABLE BACK-CHECK



5 YEAR WARRANTY

[Click Here For Info.](#)



FEATURES

- Series 880 has adjustable Back-Check function controlled by a separate regulating valve, adjustable after installation.
- **Grade 2 Underwriters' Laboratories Inc. Listed.**
- Range of sizes:
 - **Standard:** 851, 852, 853, 854 and 855
 - **Back-Check:** 883, 884 and 885
- Two Adjustment Valves: Closing and Latching speeds controlled by separate regulating valves, adjustable after installation.
- Universal application. Non-handed for standard, top jamb or parallel arm installation.
- Available with regular, hold-open or fusible link hold open arms.
- Regular arms are equipped with a 15% (+)(-) 7½% power adjustment bracket.
- Hold-open arms are adjustable for holding from 90° to 180°.
- Rack and pinion mechanism contained in a high tensile precision cast aluminum housing assures the highest quality.
- Stable hydraulic door check fluid for any climatic operation and constant lubrication.
- Narrow design permits installation on most modern glass and aluminum doors without adaptors.

FINISHES

- AL - Aluminum
- DU - Storefront Bronze

5 YEAR WARRANTY

GRADE 2



• 850 & 880 Series Closing and Latching Adjustment Valves



• 880 Series Back-Check Adjustment Valve

TECHNICAL DIMENSIONS

Description	Dimensions			
	1	2	3	4 & 5
A. Length of Closer Body	7 1/8"	8 1/16"	8 7/8"	9 3/4"
B. Horizontal Mounting Holes	6 1/2"	7 3/8"	8 3/16"	9 1/16"
C. Vertical Mounting Holes	3/4"	3/4"	3/4"	3/4"
D. Overall Height	4 1/16"	4 3/4"	4 3/4"	4 3/4"
E. Top of Door to Bottom of Closer	1 15/16"	2 1/4"	2 1/4"	2 1/4"
F. Closer Body Height	1 5/8"	1 3/4"	1 3/4"	1 3/4"
G. Projection from Door	2 9/16"	3"	3"	3"

Size 1 Meets ADA Requirements

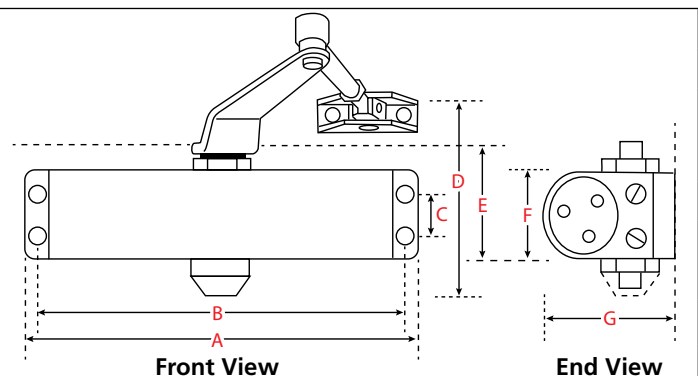

International Door Closers, Inc.

COPYRIGHT 2021 INTERNATIONAL DOOR CLOSERS, INC

INSTALLATION TYPES

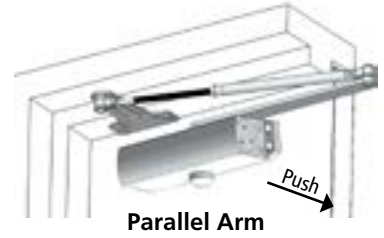
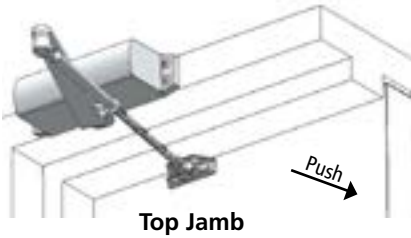
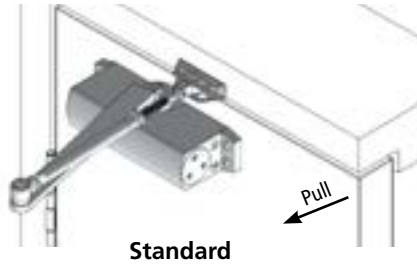

INTERIOR DOOR SIZE	EXTERIOR DOOR SIZE		TYPE	MODEL NUMBER	
	Swing Out	Swing In		Standard	Back-Check
32" 28"	28" 24"	24" —	Regular Arm Parallel Arm	851 851-P	
36" 32" 36" 32"	32" 28" 32" 28"	28" 24" 28" 24"	Regular Arm Parallel Arm Hold-Open Arm Parallel Hold-Open Arm	852 852-P 1852 1852-P	
42" 36" 42" 36"	36" 32" 36" 32"	32" 28" 32" 28"	Regular Arm Parallel Arm Hold-Open Arm Parallel Hold-Open Arm	853 853-P 1853 1853-P	883 883-P 1883 1883-P
48" 42" 48" 42"	42" 36" 42" 36"	36" 32" 36" 32"	Regular Arm Parallel Arm Hold-Open Arm Parallel Hold-Open Arm	854 854-P 1854 1854-P	884 884-P 1884 1884-P
54" 48" 54" 48"	48" 42" 48" 42"	42" 36" 42" 36"	Regular Arm Parallel Arm Hold-Open Arm Parallel Hold-Open Arm	855 855-P 1855 1855-P	885 885-P 1885 1885-P

850 & 880 Series Parts	Description	Size	1	2	3	4 & 5	NOTE: Doors of unusual height or weight, or doors subject to severe wind or draft conditions, or abusive usage, require the next larger model closer than the schedule. SPECIFY: Closer Model or Part Number SPECIFY FINISH: AL - Aluminum DU - Storefront Bronze
	Main Arm	Part #	510	520	520	520	
	Regular Forearm	Part #	511	521	521	521	
	Hold-Open Forearm	Part #	None-	522	522	522	
	Parallel Bracket for Regular Arm	Part #	515	525	525	525	
	Flat Drop Bracket	Part #	None -	527	537	547	
	Top Jamb Bracket	Part #	None -	None -	TJB-53	TJB-54	
	Dress Cover	Part #	None	None	DC-8000	DC-8000	
	Thru Bolt & Grommet Nut (Set of 4 each)	Part #	TBGN-50	TBGN-50	TBGN-50	TBGN-50	



FIXED SPRING POWER SURFACE APPLIED

1800 SERIES

GRADE 1 • FIRE RATED • HANDICAP



5 YEAR WARRANTY

[Click Here For Info.](#)



FEATURES

- Narrow design permits installation on most glass and aluminum doors without adapters
- Standard application for regular arm and Top Jamb installation; parallel arm installation
- Two Adjustment Valves: Closing and Latching speeds controlled by separate regulating valves, adjustable after installation. (Three valves with optional back-check)
- Ranges of Sizes
 - Standard: 1802, 1803, 1804, and 1805
 - Back-Check: 1803-BC, 1804-BC, and 1805-BC

FINISHES

- AL - Aluminum
- DU - Storefront Bronze

5 YEAR WARRANTY

OPTIONS AVAILABLE

- Slim or Full Plastic Cover
- Hold-Open Arm
- Drop Plates
- Sex Nuts and Bolts

TECHNICAL DIMENSIONS



• Closing and Latching Adjustment Valves



• 1803-BC, 1804-BC and 1805-BC Series Back-Check Adjustment Valve

Description	Dimensions
A. Length of Closer Body	9-3/4"
B. Horizontal Mounting Holes	9-1/16"
C. Vertical Mounting Holes	3/4"
D. Closer Body Height	1-31/32"
E. Projection from Door	2-29/32"

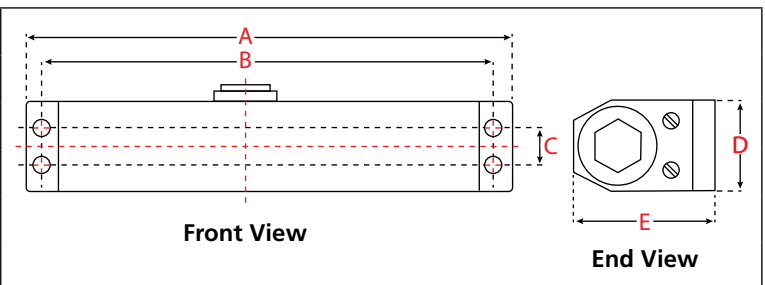

International Door Closers, Inc.

COPYRIGHT 2021 INTERNATIONAL DOOR CLOSERS, INC

INSTALLATION TYPES

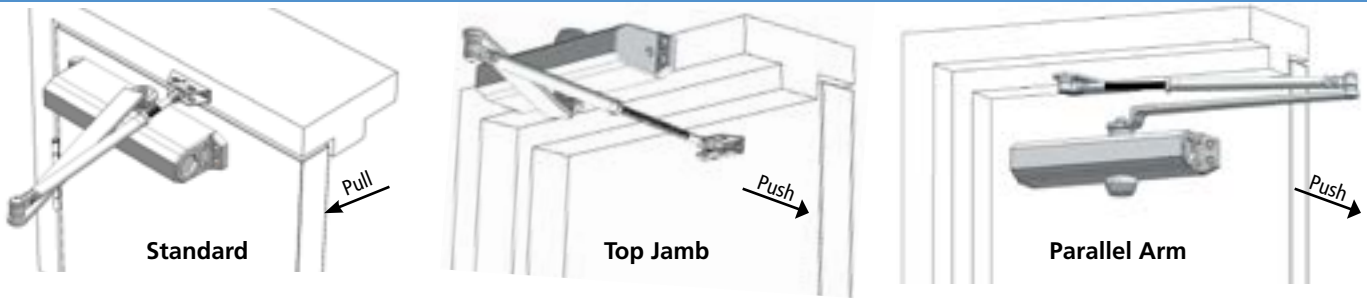

Maximum Size of Door							Applicable Door Weight Lbs (Kg)
Regular & Top Jamb				Parallel Arm			
Closer Size	Interior	Exterior Inswing	Exterior Outswing	Closer Size	Interior	Exterior Outswing	
2	36" (0.91m)			2	30" (0.76m)		66-99 (30-45)
3	42" (1.07m)	30" (0.76m)	36" (0.91m)	3	36" (0.91m)	30" (0.76m)	99-143 (45-65)
4	48" (1.22m)	36" (0.91m)	42" (1.07m)	4	42" (1.07m)	36" (0.91m)	143-187 (65-85)
5	54" (1.37m)	42" (1.07m)	48" (1.22m)	5	48" (1.22m)	42" (1.07m)	178-264 (85-120)

MODEL	SIZE	TYPE
1802	2	Standard
1803	3	Standard
1803-BC	3	Back-Check
1804	4	Standard
1804-BC	4	Back-Check
1805	5	Standard
1805-BC	5	Back-Check

1800 SERIES PARTS AND ACCESSORIES	DESCRIPTION	PART NO.	<p>NOTE: Doors of unusual height or weight, or doors subject to severe wind or draft conditions, or abusive usage, require one or two more full turns of hex spring adjustment nut than shown on the Installation instructions.</p> <p>SPECIFY: Closer Model or Part Number</p> <p>SPECIFY FINISH: Al-Aluminum DU -Storefront Bronze</p>
	Main Arm	520	
	Regular Forearm	521	
	Hold-Open Forearm *Hold-Open Forearm in lieu of standard	522 522*	
	Parallel Bracket for Regular Arm	525	
	Flat Drop Bracket for Closers - With Dress Cover	547	
	Dress Cover	DC-8000	
	Thru Bolt & Grommet Nut (Set of 4 each) *Packed With Closer in lieu of standard	TBGN-50 TBGN-50*	
	Sex Nuts & Bolts	18-SN	

West: 800-544-4422 • East: 800-225-6737
www.intldoorclosers.com



ADJUSTABLE SPRING POWER - SURFACE APPLIED CLOSER

5000-TP SERIES

GRADE 1 • HANDICAP



5 YEAR WARRANTY

[Click Here For Info.](#)



FEATURES

- **Model 5001-TP**
- ADA (Handicap) multi-sized closer with adjustable spring power for a range of sizes. 1-6 adjustable back check and delay action, adjustable after installation.
- Two Speed Control Valves: Closing and latching speeds controlled by separate regulating valves, adjustable after installation.
- Universal application. Non-handed for standard, top jamb or parallel arm installation.
- Furnished with dress cover and PA bracket.
- Rack and pinion mechanism contained in a high tensile precision cast aluminum housing.
- Stable hydraulic door check fluid for any climatic operation and constant lubrication.
- Optional, hold-open arms.
- Hold-open arms are adjustable for holding from 90° to 180°

FINISHES

- AL - Aluminum
- DU - Storefront Bronze

5 YEAR WARRANTY



• Spring Power Adjustment



• Latching and Sweep Adjustment Valves



• Back-Check and Delay Adjustment Valve

TECHNICAL DIMENSIONS

Description	WITH DRESS COVER	NO DRESS COVER
A. Length of Closer Body	13"	12 ¹¹ / ₁₆ "
B. Horizontal Mounting Holes	12"	12"
C. Vertical Mounting Holes	³ / ₄ "	³ / ₄ "
D. Overall Height	5 ¹ / ₈ "	5 ¹ / ₁₆ "
E. Top of Door to Bottom of Closer	3 ¹ / ₂ "	3 ⁷ / ₁₆ "
F. Closer Body Height	3"	2 ⁷ / ₈ "
G. Projection from Door	2 ⁵ / ₁₆ "	2 ³ / ₁₆ "

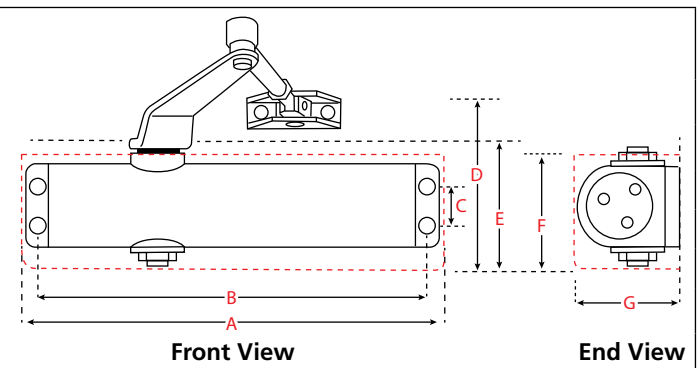

International Door Closers, Inc.





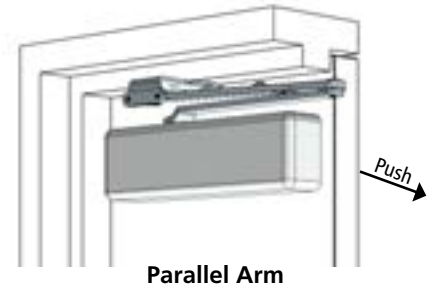
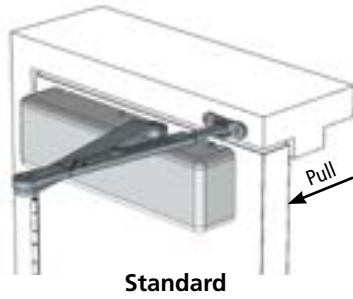

COPYRIGHT 2021 INTERNATIONAL DOOR CLOSERS, INC

INSTALLATION TYPES



TYPICAL INSTALLATIONS (REGULAR ARMS SHOWN) Hold-Open Arms are similar

5000-TP SERIES	TYPE
5001-TP With Dress Cover	Regular Arm Parallel Arm Hold-Open Arm (Optional) Parallel Hold-Open Arm (Optional)

5000-TP SERIES PARTS AND ACCESSORIES	DESCRIPTION	PART NO.	NOTE: Doors of unusual height or weight, or doors subject to severe wind or draft conditions, or abusive usage, require one or two more full turns of hex spring adjustment nut than shown on the Installation instructions. SPECIFY: Closer Model or Part Number SPECIFY FINISH: Al-Aluminum DU -Storefront Bronze
	Complete Arm Assembly	501	
	Hold-Open Forearm Hold-Open Forearm in lieu of standard*	522 522*	
	Parallel Bracket for Regular Arm	525	
	Dress Cover	DC-5000	
	Thru Bolt & Grommet Nut (Set of 4 each) Packed With Closer in lieu of standard*	TBGN-50 TBGN-50*	
	Sex Nuts & Bolts	18-SN	

*in lieu of standard

5000-TP SERIES COMPARISON FOOTPRINT CHART (12" X 3/4")							
Advantage 6000	Arrow 5016N	Cal Royal CR801	Calibre 5501, 5502, 5503	Design Hardware 316, 316R	Dexter Commercial DCM1000	Dorma 8600	EZ-Set DO 2
Falcon/Dor-O-Matic SC80	General Lock C7000	Global (Imperial USA) TC400, TC500	Hager 5200	Harney Hardware DC8300	Inox/Unison Hardware DC85	Lawrence Hardware LH816	LCN 1450
LSDA DC6716	Marshall Best QDC-85	MaxGrade MDC200	Norton 210, 8000	Pamex GC6800	PDQ 5300, 5500	PLS DC1816	Sargent 1313
Seco-Larm SD-C101-SBAQ	Sentinel 9016	Stanley/K2 QDC200	Tell 800	Townsteel TDC85	Yale 2500 (Discontinued), 2700, 3000		

West: 800-544-4422 • East: 800-225-6737
www.intldoorclosers.com



SURFACE APPLIED GRADE 1 CLOSER
8000-TP SERIES
 GRADE 1 • FIRE RATED • HANDICAP



5 YEAR WARRANTY
[Click Here For Info.](#)



FEATURES

- **Model 8051-TP** Standard with Sweep, Latching, and Back-Check
- **Model 8052-TP** Standard with Sweep, Latching, and Delayed Action
- Adjustable Spring Power Size 1 through 6
- Cast Aluminum body; forged steel arm
- Tri-packed for regular arm, top jamb and parallel arm application
- Hold-open arms are adjustable for holding from 90° to 180°

OPTIONS AVAILABLE

- Drop Plate, Hold Open Arm
- Replacement for Norton 1600 or 1601



FINISHES

- AL - Aluminum
- DU - Storefront Bronze

5 YEAR WARRANTY

TECHNICAL DIMENSIONS

Description	Dimensions
A. Length of Closer Body	9-3/4" (248 mm)
B. Horizontal Mounting Holes	9-1/16" (230 mm)
C. Vertical Mounting Holes	3/4" (19 mm)
D. Closer Body Height	1-13/16" (46 mm)
E. Projection from Door	2-3/4" (70 mm)

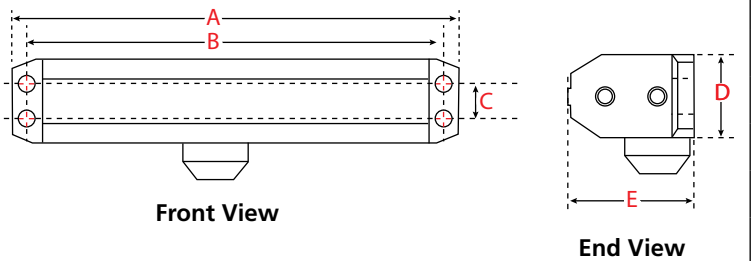

INSTALLATION TYPES

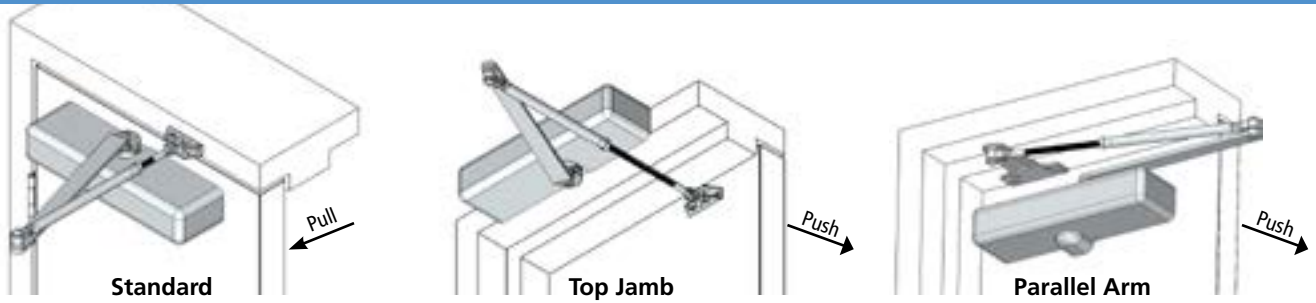

TYPICAL INSTALLATIONS (REGULAR ARMS SHOWN) Hold-Open Arms are similar

MODEL NO.		Size
Tri-packed; With Back-Check	Tri-packed; With Delayed Action	
8051-TP	8052-TP	1-6

Regular & Top Jamb				Parallel Arm			Applicable Door Weight Lbs (Kg)
Maximum Size of Door							
Closer Size	Interior	Exterior Inswing	Exterior Outswing	Closer Size	Interior	Exterior Outswinging	
1	28" (0.71m)			1			33-66 (15-30)
2	36" (0.91m)			2	30" (0.76m)		66-99 (30-45)
3	42" (1.07m)	30" (0.76m)	36" (0.91m)	3	36" (0.91m)	30" (0.76m)	99-143 (45-65)
4	48" (1.22m)	36" (0.91m)	42" (1.07m)	4	42" (1.07m)	36" (0.91m)	143-187 (65-85)
5	54" (1.37m)	42" (1.07m)	48" (1.22m)	5	48" (1.22m)	42" (1.07m)	178-264 (85-120)
6	60" (1.52m)	48" (1.22m)	54" (1.37m)	6	54" (1.37m)	48" (1.22m)	264-330 (120-150)

8000-TP SERIES PARTS AND ACCESSORIES	DESCRIPTION	PART NO.	NOTE: Doors of unusual height or weight, or doors subject to severe wind or draft conditions, or abusive usage, require one or two more full turns of hex spring adjustment nut than shown on the Installation instructions. SPECIFY: Closer Model or Part Number SPECIFY FINISH: Al-Aluminum DU -Storefront Bronze
	Main Arm	520	
	Regular Forearm	521	
	Hold-Open Forearm *Hold-Open Forearm in lieu of standard	522 522*	
	Parallel Bracket for Regular Arm	525	
	Flat Drop Bracket for Closers - With Dress Cover	547	
	FTop Jamb Bracket	TJB-54	
	Dress Cover	DC-8000	
	Thru Bolt & Grommet Nut (Set of 4 each) *Packed With Closer in lieu of standard	TBGN-50	
	Sex Nuts & Bolts	18-SN	

*in lieu of standard

West: 800-544-4422 • East: 800-225-6737
www.intldoorclosers.com



ADJUSTABLE SPRING POWER - SURFACE GRADE 1 CLOSER

9000-TP SERIES

GRADE 1 • ADA HANDICAP



5 YEAR WARRANTY

[Click Here For Info.](#)

FEATURES

- **Model 9001-TP:** Adjustable spring power (1-6) Opening Force with adjustable back check and delayed action controlled by a separate regulating valve.
- ADA (Handicap) multi-sized closer with adjustable Spring Power for a range of sizes adjustable after installation.
- Two Speed Control Valves: Closing and Latching speeds controlled by separate regulating valves, adjustable after installation.
- Universal Application: Non handed for standard, top jamb or parallel arm installation (parallel arm bracket included).
- Rack and pinion mechanism contained in a high tensile precision cast aluminum housing.
- Stable hydraulic door check fluid for any climatic operation and constant lubrication.
- Furnished with a high impact molded PVC Dress Cover (door closer body casting is finished for use without the dress cover).
- Optional hold-open arms available.
- Hold-open arms are adjustable for holding from 90° to 180°



5 YEAR WARRANTY

- Adjustment Valves

FINISHES

- AL - Aluminum
- DU - Storefront Bronze



9001-TP Series Comparison Footprint Chart (11-1/8" x 3/4")

Cooper Creek/Bulldog CL8600	Taymor 1900
--------------------------------	----------------

TECHNICAL DIMENSIONS

Description	NO DRESS COVER
	9001-TP
A. Length of Closer Body	11 7/8"
B. Horizontal Mounting Holes	11 1/8"
C. Vertical Mounting Holes	3/4"
D. Overall Height	4 9/16"
E. Top of Door to Bottom of Closer	3 5/16"
F. Closer Body Height	2 13/16"
G. Projection from Door	2 9/16"

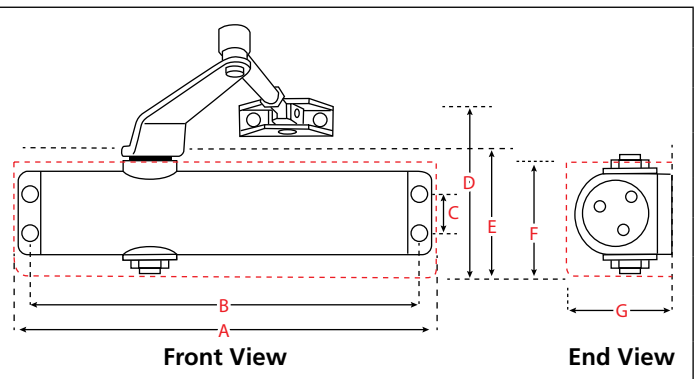

International Door Closers, Inc.





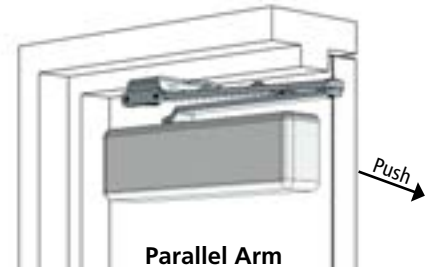
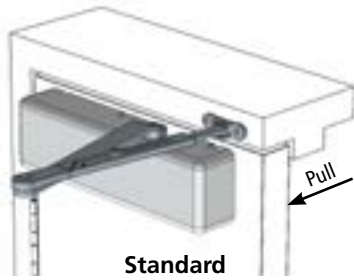



COPYRIGHT 2021 INTERNATIONAL DOOR CLOSERS, INC

INSTALLATION TYPES



TYPICAL INSTALLATIONS (REGULAR ARMS SHOWN) Hold-Open Arms are similar

MODEL NO.	TYPE
Back-Check / Delayed Action	
9001-TP	Regular Arm

9000-TP SERIES PARTS AND ACCESSORIES	DESCRIPTION	PART NO.
	Complete Arm Assembly	901
	Hold-Open Forearm *Hold-Open Forearm in lieu of standard	522 522*
	Top Jamb Forearm Extender	514
	Parallel Bracket for Regular Arm	525
	Flat Drop Bracket for Closers - With Dress Cover	9007
	FTop Jamb Bracket	TJB-9000
	Thru Bolt & Grommet Nut (Set of 4 each) *Packed With Closer in lieu of standard	TBGN-50
	Sex Nuts & Bolts	18-SN

*in lieu of standard



CROSS REFERENCE CHART

SURFACE CLOSERS

44CI SERIES COMPARISON FOOTPRINT CHART (5" X 2-1/4")

Advantage 8000	Arrow DC500	C.R. Laurance PR90	Cal Royal CR441	Calibre 4001	Cooper Creek/Bulldog CL8844
Deltana DC40	Design Hardware 416	EZ-Set DO 4	General Lock C9000	Global (Imperial USA) TC4300	Hager 5100
Harney Hardware DC8400	Independace2 4040	Inox/Unison Hardware DC90	Lawrence Hardware LH8016	LCN 4040XP, 4041	LSDA DC6816
Marshall Best QDC-40	MaxGrade MDC100	Norton 410, 9540	Pamex GC4400	PDQ 7100	PLS DC1916
S. Parker 441BC	Seco-Larm SD-C101-SBBQ	Sentinel 4016	Stanley/K2 QDC100	Taymor 4000	Tell 900
Townsteel TDC40	Yale 5800				

854, 855, 884, 885 SERIES COMPARISON FOOTPRINT CHART (9-1/6" X 3/4")

Advantage 4000-5000	Arrow 900N, DC300	C.R. Laurance DC54, DC55, PR40, PR80	Cal Royal 300, 500, 740, 750	Calibre 6504, 6505, 6804, 6805, 8001, 8002, 8003, 8854, 8855, 8884, 8885	Cooper Creek/Bulldog CL8400
Corbin Russwin DC4600	Deltana DC10	Design Hardware 116	Dexter Commercial DCL2000, DCR8000	Dorma 7200, 7300, U1500	Dorex 754, 755, 1700, 5400
EZ-Set DO 1, DO 74, DO 75, DO 513, DO 536	Falcon/Dor-O- Matic SC60, SC93, SC94	General Lock C3004, C3005, C5000	Global (Imperial USA) TC200	Hager 5300, 5400	Harney Hardware DC8900
Independace2 2014	Inox/Unison Hardware DC61	Lawrence Hardware LH5016	LCN 1250, 1260	LSDA DC84, DC724, DC914, DC925, DC6124	Marshall Best QDC-54, QDC-90
MaxGrade MDC300	Norton 160, 1600, 9300BC	Pamex GC8700	PDQ 3100	PLS DC230, DC330, DC340, DC1614, DC1636	Progressive K740
S. Parker 815BC, 950	Sargent 1131	Sargent-Bradford B81, B82502	Seco-Larm SD-C101-SGQ	Sentinel 5000	Stanley/K2 D1610, QDC300
Taymor 604, 694	Tell 500, 600	Townsteel TDC54, TDC90	Yale 50, 1100 (Discontinued), 2300 (Discontinued)		

853, 883 SERIES COMPARISON FOOTPRINT CHART (8-3/16" X 3/4")

Advantage 3000	C.R. Laurance DC52, DC53	Cal Royal 720730	Calibre 6502, 6503, 8853, 8883	Dorex 752, 753	EZ-Set DO 502, DO 503, DO 504	General Lock C3003
Global (Imperial USA) TC2203	Lawrence Hardware LH503, LH534	Marshall Best QDC-53	Progressive K730	Sargent-Bradford B82302	Sentinel 5003	Townsteel TDC53

1800 SERIES COMPARISON FOOTPRINT CHART (9-1/6" X 3/4")							
Advantage 4000-5000	Arrow 900N, DC300	C.R. Laurance DC54, DC55, PR40, PR80	Cal Royal 300, 500, 740, 750	Calibre 6504, 6505, 6804, 6805, 8001, 8002, 8003, 8854, 8855, 8884, 8885	Cooper Creek/ Bulldog CL8400	Corbin Russwin DC4600	Deltana DC10
Design Hardware 116	Dexter Com- mercial DCL2000, DCR8000	Dorma 7200, 7300, U1500	Dorex 754, 755, 1700, 5400	EZ-Set DO 1, DO 74, DO 75, DO 513, DO 536	Falcon/Dor-O-Matic SC60, SC93, SC94	General Lock C3004, C3005, C5000	Global (Imperial USA) TC200
Hager 5300, 5400	Harney Hardware DC8900	Independace2 2014	Inox/Unison Hardware DC61	Lawrence Hardware LH5016	LCN 1250, 1260	LSDA DC84, DC724, DC914, DC925, DC6124	Marshall Best QDC-54, QDC-90
MaxGrade MDC300	Norton 160, 1600, 9300BC	Pamex GC8700	PDQ 3100	PLS DC230, DC330, DC340, DC1614, DC1636	Progressive K740	S. Parker 815BC, 950	Sargent 1131
Sargent-Bradford B81, B82502	Seco-Larm SD-C101-SGQ	Sentinel 5000	Stanley/K2 D1610, QDC300	Taymor 604, 694	Tell 500, 600	Townsteel TDC54, TDC90	Yale 50, 1100 (Discontinued), 2300 (Discontinued)

5000-TP SERIES COMPARISON FOOTPRINT CHART (12" X 3/4")							
Advantage 6000	Arrow 5016N	Cal Royal CR801	Calibre 5501, 5502, 5503	Design Hardware 316, 316R	Dexter Commercial DCM1000	Dorma 8600	EZ-Set DO 2
Falcon/Dor-O-Matic SC80	General Lock C7000	Global (Imperial USA) TC400, TC500	Hager 5200	Harney Hardware DC8300	Inox/Unison Hardware DC85	Lawrence Hardware LH816	LCN 1450
LSDA DC6716	Marshall Best QDC-85	MaxGrade MDC200	Norton 210, 8000	Pamex GC6800	PDQ 5300, 5500	PLS DC1816	Sargent 1313
Seco-Larm SD-C101-SBAQ	Sentinel 9016	Stanley/K2 QDC200	Tell 800	Townsteel TDC85	Yale 2500 (Discontinued), 2700, 3000		

8000-TP Series Comparison Footprint Chart (9-1/6" x 3/4")							
Advantage 4000-5000	Arrow 900N, DC300	C.R. Laurance DC54, DC55, PR40, PR80	Cal Royal 300, 500, 740, 750	Calibre 6504, 6505, 6804, 6805, 8001, 8002, 8003, 8854, 8855, 8884, 8885	Cooper Creek/ Bulldog CL8400	Corbin Russwin DC4600	Deltana DC10
Design Hardware 116	Dexter Com- mercial DCL2000, DCR8000	Dorma 7200, 7300, U1500	Dorex 754, 755, 1700, 5400	EZ-Set DO 1, DO 74, DO 75, DO 513, DO 536	Falcon/Dor-O-- Matic SC60, SC93, SC94	General Lock C3004, C3005, C5000	Global (Imperial USA) TC200
Hager 5300, 5400	Harney Hardware DC8900	Independace2 2014	Inox/Unison Hardware DC61	Lawrence Hardware LH5016	LCN 1250, 1260	LSDA DC84, DC724, DC914, DC925, DC6124	Marshall Best QDC-54, QDC-90
MaxGrade MDC300	Norton 160, 1600, 9300BC	Pamex GC8700	PDQ 3100	PLS DC230, DC330, DC340, DC1614, DC1636	Progressive K740	S. Parker 815BC, 950	Sargent 1131
Sargent-Bradford B81, B82502	Seco-Larm SD-C101- SGQ	Sentinel 5000	Stanley/K2 D1610, QDC300	Taymor 604, 694	Tell 500, 600	Townsteel TDC54, TDC90	Yale 50, 1100 (Discontinued), 2300 (Discontinued)

9001-TP Series Comparison Footprint Chart (11-1/8" x 3/4")	
Cooper Creek/Bulldog CL8600	Taymor 1900

West: 800-544-4422 • East: 800-225-6737
www.intldoorclosers.com



SWINGING DOOR HARDWARE • GRADE 2

DEADLOCKS & DEADLATCHES

DT-1850, DH-1820-H, DH-1820-S, DL-4510 & FACEPLATES



DT-1850

- **DT-1850** "Long Throw" Deadlock
- **CYLINDER BACKSET AVAILABLE:**
- 31/32", 1-1/8" and 1-1/2"
- Bolt 1-3/8" throw, made of 5 ply laminated steel with a hardened roller pin in a case hardened center ply for maximum security.
- Lock accepts standard 1-5/32" Mortise Key or Thumbturn Cylinders with AR MS-Type cam
- **SPECIFY:** Cylinder Backset



DH-1820-H • DH-1820-S

- **DH-1820-H** "Hook Bolt" Deadlock
- **DH-1820-S** "Short Throw" Deadlock
- **CYLINDER BACKSET AVAILABLE:**
- **DH-1820-H:** 31/32", 1-1/8" and 1-1/2"
- **DH-1820-S:** 1-1/8"
- Bolt 1 3/16" throw, made of 5 ply laminated steel with a hardened roller pin in a case hardened center ply for maximum security.
- Lock accepts standard 1-5/32" Mortise Key or Thumbturn Cylinders with AR MS-Type cam
- **SPECIFY:** Cylinder Backset



DL-4510

- **DL-4510** Deadlatch lock
- **CYLINDER BACKSET AVAILABLE:**
- 31/32" and 1-1/8"
- Field reversible for opposite hand
- Key controlled dogging
- Latch bolt 1/2" throw, Chrome plated with Delrin insert for smooth, quiet latching
- Lock accepts standard 1-5/32" Mortise Key or Thumbturn Cylinders with AR MS-Type cam
- SS-4510 Strike included, US 26D
- **SPECIFY:** Cylinder Backset
Hand if pre-handing required

FACEPLATES 1" x 6-7/8"

- **FACEPLATE FINISHES:**
AL - Anodized Satin Aluminum
BK - Anodized Black
DU - Anodized Bronze
- **SPECIFY:** Part Number and Finish



For Use With:	Flat	Radius	Radius Weather-Stripping	Left Hand Beveled	Right Hand Beveled
DH-1820-H DH-1820-S	FP-1821	FP-1822	FP-1823	FP-1824	FP-1825
DT-1850	FP-1851	FP-1852	FP-1853	FP-1854	FP-1855
DL-4510	FP-4511	FP-4512	FP-4513	FP-4514	FP-4515

International Door Closers, Inc.

COPYRIGHT 2021 INTERNATIONAL DOOR CLOSERS, INC

DEADLOCKS & DEADLATCHES	
31/32" OR 1-1/8" CYLINDER BACKSET	
DH-1820-H	Hook Bolt Deadlock Only
DH-1821-H	Hook Bolt Deadlock, Flat Faceplate
DH-1822-H	Hook Bolt Deadlock, Radius Faceplate
DH-1823-H	Hook Bolt Deadlock, Radius Weatherstripped
DH-1824-H	Hook Bolt Deadlock, Left Hand Beveled Faceplate
DH-1825-H	Hook Bolt Deadlock, Right Hand Beveled Faceplate
DH-1820-S	Short Throw Deadlock, 1-1/8" Backset
DH-1821-S	Short Throw Deadlock, Flat Faceplate
DH-1822-S	Short Throw Deadlock, Radius Faceplate
DH-1823-S	Short Throw Deadlock, Radius Weatherstripped
DH-1824-S	Short Throw Deadlock, Left Hand Beveled Faceplate
DH-1825-S	Short Throw Deadlock, Right Hand Beveled Faceplate
DT-1850	Long Throw Deadlock Only
DT-1851	Long Throw Deadlock, Flat Faceplate
DT-1852	Long Throw Deadlock, Radius Faceplate
DT-1853	Long Throw Deadlock, Radius Weatherstripped
DT-1854	Long Throw Deadlock, Left Hand Beveled Faceplate
DT-1855	Long Throw Deadlock, Right Hand Beveled Faceplate
DL-4510	Deadlatch Only, Field Reversible
DL-4511	Deadlatch Deadlock, Flat Faceplate
DL-4512	Deadlatch Deadlock, Radius Faceplate
DL-4513	Deadlatch Deadlock, Radius Weatherstripped
DL-4514	Deadlatch Deadlock, Left Hand Beveled Faceplate
DL-4515	Deadlatch Deadlock, Right Hand Beveled Faceplate
1-1/2" CYLINDER BACKSET	
DH-1820-H	Hook Bolt Deadlock Only
DH-1821-H	Hook Bolt Deadlock, Flat Faceplate
DH-1822-H	Hook Bolt Deadlock, Radius Faceplate
DH-1823-H	Hook Bolt Deadlock, Radius Weatherstripped
DH-1824-H	Hook Bolt Deadlock, Left Hand Beveled Faceplate
DH-1825-H	Hook Bolt Deadlock, Right Hand Beveled Faceplate
DT-1850	Long Throw Deadlock Only
DT-1851	Long Throw Deadlock, Flat Faceplate
DT-1852	Long Throw Deadlock, Radius Faceplate
DT-1853	Long Throw Deadlock, Radius Weatherstripped
DT-1854	Long Throw Deadlock, Left Hand Beveled Faceplate
DT-1855	Long Throw Deadlock, Right Hand Beveled Faceplate

FACEPLATES			
FOR USE WITH			
DH-1820-H DH-1820-S	DT-1850	DL-4510	
FP-1821	FP-1851	FP-4511	Flat
FP-1822	FP-1852	FP-4512	Radius
FP-1823	FP-1853	FP-4513	Radius Weatherstripped
FP-1824	FP-1854	FP-4514	Left Hand Beveled
FP-1825	FP-1855	FP-4515	Right Hand Beveled



PADDLE HANDLE • CAM PLUG • LEVER HANDLE
SWINGING DOOR
 HARDWARE

PH-4520 PADDLE HANDLE

- For use with DL-4510 type Latch Lock
- “Push” or “Pull” Paddle Handle
- Field reversible for opposite hand with PUSH and PULL Plates included
- Cam Plug, field reversible, included
- Extruded Aluminum Handle

Finishes Available:

- AL - Handle anodized Satin Aluminum Housing baked Satin Aluminum paint
- DU - Handle anodized Storefront Bronze Housing baked Storefront Bronze paint



CP-4560 CAM PLUG

- For use with HL-4560 Lever Handle and PH-4520 Paddle Handle
- Non-handed, field reversible

Specify: Model Number and Finish

ORDERING INFORMATION

PH-4521 PUSH To The Left	PH-4523 PUSH To The Left
PH-4522 PUSH To The Right	PH-4524 PUSH To The Right

Specify: Model Number and Finish

LEVER & PADDLE HANDLES

	DESCRIPTION
PH-4521	Paddle Handle with Cam Plug, “Push” to the Left
PH-4522	Paddle Handle with Cam Plug, “Push” to the Right
PH-4523	Paddle Handle with Cam Plug, “Push” to the Left
PH-4524	Paddle Handle with Cam Plug, “Push” to the Right
CP-4560	Cam Plug Only
HL-4560	Lever Handle with Cam Plug

HL-4560 LEVER HANDLE

- For use with DL-4510 type Latch Lock
- Cam Plug. field reversible.
- Finishes Available:
 - AL - Baked Satin Aluminum
 - BK - Baked Black Paint
 - DU - Baked Storefront Bronze Paint

Specify: Hand if pre-handing required Finish



FB-1200 FLUSHBOLT

- 15/16" x 4-1/4" Radius Face
- Positive "U" joint actuator with 5/8" throw ..
- 1/8", 3/16" and 1/4" offset with 7/8" backset
- Rod length for 12" Centerline of face installation
- Square Nylon Tip with beveled corners fits in 1/2" square hole
- Finishes Available:
 - AL - Baked Satin Aluminum Paint
 - BK - Baked Black Paint
 - DU - Baked Storefront Bronze Paint

ORDERING INFORMATION

FB-1201 1/8" offset, without guide
FB-1202 1/8" offset, with guide
FB-1203 1/4" offset, without guide
FB-1204 1/4" offset, with guide
FB-1205 3/16" offset, without guide
FB-1206 3/16" offset, with guide

Specify: Model Number Standard or Extended Hole Guide Finish

FB-1201-K FLUSH BOLT

- 15/16" x 4-1/4" Radius Face
- Positive "U" joint actuator with 5/8" throw
- 1/8" offset with 11/16" backset
- Square Nylon Tip with beveled corners fits in 1/2" square hole
- Finishes Available:
 - AL - Baked Satin Aluminum Paint
 - BK - Baked Black Paint
 - DU - Baked Storefront Bronze Paint

Specify: Finish

FG-1200 STANDARD FLUSH BOLT GUIDE

- For use with FB-1200 and FB-2200 Flush bolts



FG-1250 EXTENDED HOLE FLUSH BOLT GUIDE

- For use with FB-1200 and FB-2200 Flush bolts



FLUSH BOLTS

HARDWARE

FB-2200 FLUSH BOLT

- 15/16" x 4-1/4" Radius Face
- Positive "U" joint actuator with 7/8" throw
- 1/8" and 1/4" offset with 7/8" backset
- Rod length for 12" Centerline of face installation
- Square Nylon Tip with beveled corners fits in 1/2" square hole
- Finishes Available:
 - AL - Baked Satin Aluminum Paint
 - BK - Baked Black Paint
 - DU - Baked Storefront Bronze Paint

ORDERING INFORMATION

FB-2201 1/8" offset, without guide
FB-2202 1/8" offset, with guide
FB-2203 1/4" offset, without guide
FB-2204 1/4" offset, with guide

Specify: Model Number Standard or Extended Hole Guide Finish

ER-1200 FLUSH BOLT EXTENSION ROD

- 1/4-20 x 12" Threaded rod
- Includes coupler

FLUSH BOLTS

Positive "U" Joint Actuator with 5/8" Throw

FB-1201	1/8" Offset with 7/8" Backset, without Guide
FB-1202	1/8" Offset with 7/8" Backset, with Guide
FB-1203	1/4" Offset with 7/8" Backset, without Guide
FB-1204	1/4" Offset with 7/8" Backset, with Guide
FB-1205	3/16" Offset with 7/8" Backset, without Guide
FB-1206	3/16" Offset with 7/8" Backset, with Guide

Positive "U" Joint Actuator with 7/8" Throw

FB-2201	1/8" Offset with 7/8" Backset, without Guide
FB-2202	1/8" Offset with 7/8" Backset, with Guide
FB-2203	1/4" Offset with 7/8" Backset, without Guide
FB-2204	1/4" Offset with 7/8" Backset, with Guide

FLUSH BOLT ACCESSORIES

ER-1200	Flush Bolt Extension Rod, 12"
FG-1200	Standard Flush Bolt Guide
FG-1250	Extended Hole Flush Bolt Guide
FR-1200-RM	Flush Bolt Rod with Round Tip
FR-1600-S	Flush Bolt Rod with Square Tip

West: 800-544-4422 • East: 800-225-6737
www.intldoorclosers.com



THRESHOLD BOLT KIT • HEADER BOLT SETS • HEADER SIGN

THRESHOLD BOLTS

HARDWARE

TB-4015 THRESHOLD BOLT KIT

For doors with cylinder height tip to 53-1/2", Threaded rod can be cut for cylinder heights lower than 53-1/2"

- Bolt 3/8" hexagon hardened steel
- 11/16" bolt throw
- Unit complete for attachment to basic Deadlock to provide two-point security

Specify: Model Number

TB-4016 THRESHOLD BOLT KIT

For doors with cylinder height 34" to 37"

- Bolt 3/8" hexagon hardened steel
- 11/16" bolt throw
- Unit complete for attachment to basic Deadlock to provide two-point security

Specify: Model Number

HB-4015-N SPECIAL HEADER BOLT SET

HB-4015-N Header Bolt Set is Standard for 83" Doors with Cylinder Heights of not less than 33"

ER-4015-N Extension Rod Kit is Available for 8'-9' Door Heights

HB-4085 HEADER BOLT SET

For doors 30-1/2" to 50" from Centerline of cylinder to top of door



HB-4086 HEADER BOLT SET

For doors 55-5/8" 72-1/2" from Centerline of cylinder to top of door

HB-4087 HEADER BOLT SET

For doors 67" to 89" from Centerline of cylinder to top of door

- Inactive leaf lock when used with basic long Throw Deadlock in active leaf
- 5/8" throw expanding bolt
- Minor adjustments can be made after installation
- Unit complete with Rod Guide and Header Strike

Specify: Model Number

HS-4090 HEADER SIGN

- For use on transoms and door headers
- One piece self-adhesive decals
- Black letters on aluminum background

Specify: Model Number

THRESHOLD BOLTS	
TB-4015	Threshold Bolt Kit for up to 53-1/2" Cylinder Height
TB-4016	Threshold Bolt Kit for 34"-37" Cylinder Height
HEADER BOLTS	
HB-4085	Header Bolt Set for 84" Height Door
HB-4086	Header Bolt Set for 96"-108" Height Door
HB-4087	Header Bolt Set for 120" Height Door
HB-4090	Header Sign
HB-4015-N	Special Header Bolt Set
ER-4015-N	Extension Rod Kit for 8'-9' Door Heights

CYLINDERS

HARDWARE

CZ-1001 (ZINC) MORTISE KEY CYLINDER

- 1" Length 5 pin Cylinder 1-5/32" diameter
- AR MS-Type cam
- Keyway available:
Schlage "C", Yale "8"
- Core face and Key US 26D
- Cylinder ring 3/16" standard, 5/32" and 7/32" optional
- Finishes Available: Specify : Keyway
AL - Anodized Satin Aluminum
BK - Anodized Black
DU - Anodized Bronze



Specify: Cylinder ring type KA-2 or KA-(quantity) Finish

DC-2001 (ZINC) MORTISE DUMMY CYLINDER

- 7/8" Length Cylinder 1-5/32" diameter
- No Keyway or cam
- Cylinder ring 3/16" standard, 5/32" and 7/32" optional
- Finishes Available: Specify: Cylinder ring type
AL - Anodized Satin Aluminum Finish
BK - Anodized Black
DU - Anodized Bronze



Specify: Cylinder ring type

RZ-1003 (ZINC) RIM CYLINDER

- 5 pin Cylinder
- Core face and Key US 26D
- Schlage "C" Keyway
- Low profile Cylinder ring and adaptor plate standard
- 1-7/8" Break-away screws and 1-1/4" Break-away Spindle standard
- Finishes Available:
AL - Anodized Satin Aluminum
BK - Anodized Black
DU - Anodized Bronze



Specify: Finish

TZ-3001 (ZINC) MORTISE THUMBTURN CYLINDER

- 1" Length Cylinder 1-5/32" diameter
- AR MS-Type cam
- Thumbturn US 26D
- Cylinder ring 3/16" standard, 5/32" and 7/32" optional
- Finishes Available:
AL - Anodized Satin Aluminum
BK - Anodized Black
DU - Anodized Bronze



Specify: Cylinder ring type

CG-4043 CYLINDER GUARD

- Hardened steel security ring
- Free-spinning beveled collar
- For standard face 5 pin Mortise key cylinder
- For use on Aluminum
- Furnished with retaining clip and two spacers
- Finishes Available:
AL - Baked Satin Aluminum Paint
BK - Baked Black Paint
DU - Baked Storefront Bronze Paint



Specify: Finish

LI-4089 LOCK INDICATOR SET

- For use with DH-1820 and DT-1850 type Deadlocks
- LOCKED in red and OPEN in green letters on white background
- Finishes Available:
AL - Baked Satin Aluminum Paint
BK - Baked Black Paint
DU - Baked Storefront Bronze Paint



Specify: Finish

CYLINDERS	
CZ-1001	Pair of Mortise Key Cylinders (Zinc) with 2 Keys & 2 Rings
DC-2001	Mortise Dummy Cylinder (Zinc) with Ring
RZ-1003	Rim Cylinder (Zinc) with 2 Keys & Ring
TZ-3001	Mortise Thumbturn Cylinder (Zinc) with Ring
CG-4043	Cylinder Guard Set
CR-1155	5/32" Cylinder Ring
CR-1195	Standard Cylinder Ring
CR-1215	7/32" Cylinder Ring

LOCK INDICATOR SET	
DC-2001	Lock Indicator Only
RZ-1003	Lock Indicator Set



DOOR PULLS & PUSH BARS

HARDWARE

OFFSET DOOR PULL PH-4000

- 1" Diameter Solid Aluminum Round
- 3-1/4" Offset
- Projection 3-1/4"
- Door Clearance 2-1/4"
- CTC 9", 10" and 12"
- Anodized Finishes AL & DU (Storefront Bronze)
- Other Finishes Available on Request
- Mounting Hardware Include

SPECIFY: Length, Finish & Mounting Hardware (T1 or T6)



OFFSET PULL SET PH-4000-2

- 1" Diameter Solid Aluminum Round
- 3-1/4" Offset
- Projection 3-1/4"
- Door Clearance 2-1/4"
- CTC 9", 10" and 12"
- Anodized Finishes AL & DU (Storefront Bronze)
- Other Finishes Available on Request
- Mounting Hardware Included (T5)

SPECIFY: Length and Finish

OFFSET PULL & DOUBLE BEND PUSH BAR SET PP-2000

- 1" Diameter Solid Aluminum Round
- Projection: See Pull/Push Specifications
- CTC: See Pull/Push Specifications
- Anodized Finishes AL & DU (Storefront Bronze)
- Other Finishes Available on Request
- Mounting Hardware Included

SPECIFY: Length, Finish & Mounting Hardware



OFFSET PULL & SINGLE BEND PUSH BAR SET PP-1000

- 1" Diameter Solid Aluminum Round
- Projection: See Pull/Push Specifications
- CTC: See Pull/Push Specifications
- Anodized Finishes AL & DU (Storefront Bronze)
- Other Finishes Available on Request
- Mounting Hardware Included

SPECIFY: Length, Finish & Mounting Hardware



MOUNTING HARDWARE FOR VARIOUS COMBINATIONS

- Single Push/Pull: Specify either T1 Thru Bolt, or T6 Concealed Mount
- Push/Pull Sets: Back to Back at Bottom of Pull, Thru Bolts on free ends

SINGLE BEND PUSH BAR PB-1000 DOUBLE BEND PUSH BAR PB-2000

- 1" Diameter Solid Aluminum Round
- Projection 2-1/4" with 1-1/4" Door Clearance
- CTC 33-1/16", 39-1/16" and 45-1/16"
- Anodized Finishes AL & DU (Storefront Bronze)
- Other Finishes Available on Request
- Mounting Hardware Included

SPECIFY: Length, Finish & Mounting Hardware (T1 or T6)



OFFSET PULL HANDLES

PH-4000-9	CTC 9"
PH-4000-10	CTC 10"
PH-4000-12	CTC 12"
PH-4000-2-9	CTC 9" Set
PH-4000-2-10	CTC 10" Set
PH-4000-2-12	CTC 12" Set
PUSH BARS	
PB-1000-33	CTC 33-1/16", Single Bend
PB-1000-39	CTC 39-1/16", Single Bend
PB-1000-45	CTC 45-1/16", Single Bend
PB-2000-33	CTC 33-1/16", Double Bend
PB-2000-39	CTC 39-1/16", Double Bend
PB-2000-45	CTC 45-1/16", Double Bend

DH-6000

HARDWARE

DH-6000

- Features
- Zinc Alloy Construction
- Non-Marking Rubber Tip
- 7" Body Height
- Mounting Screws Included:
 - (2) #10 x 1-1/2" Flat Head Wood / Sheet Metal Screws
 - (1) #10 x 1/2" Flat Head Wood / Sheet Metal Screws
 - (2) #10 x 1-1/2" Self Drilling / Self Tapping Screws
 - (1) #10 x 1/2" Self Drilling / Self Tapping Screws
- Weight 1lb.
- Finishes Available:
 - AL - Aluminum
 - DU- Storefront Bronze



DH-6000-TIP

- Replacement Rubber Tip



KICK DOWN HOLDERS	
DH-6000	Heavy Duty Kick Down Holder
DH-6000-TIP	Replacement Rubber Bottom Tip



OFFSET • INTERMEDIATE • CENTER HUNG

PIVOT SETS

HARDWARE

OP-7000 OFFSET PIVOT SET (KAWNEERTYPE)

- A380 Precision die cast aluminum
- Oilite bronze bushing in top frame portion
- Full race ball bearing in bottom door portions
- Door height adjustable by bottom door portion
- Case hardened stud in floor/jamb portion
- Includes steel reinforcement plates for the door portions

- Finishes Available:
AL - Baked Satin Aluminum Paint
BK - Baked Black Paint
DU - Baked Storefront Bronze Paint



Top Frame Pivot Portion
(includes fasteners)
Kawneer P/N 50-321

Top Door Pivot Portion
(includes fasteners and reinforcement plate)
Kawneer P/N 50-320



Bottom Door Pivot Portion
(includes fasteners and reinforcement plate)
Kawneer P/N 50-323

Floor/Jamb Pivot Portion
(includes fasteners)
Kawneer P/N 50-325(LH)
Kawneer P/N 50-324(RH)

Specify: Model Number and Finish

IP-1900 INTERMEDIATE PIVOT SET

- 3/4" Offset for use with Aluminum Doors and Frames
- Full race ball bearing backed by an oilite bronze bushing in the door portion
 - Case hardened pin in jamb portion fully retractable for ease of installation
 - Easy vertical adjustment
 - Precision Aluminum die cast
 - For doors up to 125lbs.
 - Finishes Available:
AL- Baked Satin Aluminum Paint
BK- Baked Black Paint
DU- Baked Storefront Bronze Paint



Ordering Information

IP-1901 Left

IP-1902 Right

Specify: Model Number and Finish

IP-2200 INTERMEDIATE PIVOT SET

- 3/4" Offset for use with Aluminum Doors and Frames
- Full race ball bearing backed by an oilite bronze bushing in the door portion
 - Case hardened pin in jamb portion fully retractable for ease of installation
 - Easy vertical adjustment
 - Precision Aluminum Extrusion
 - For doors up to 125lbs.
 - Finishes Available:
AL- Baked Satin Aluminum Paint
BK- Baked Black Paint
DU- Baked Storefront Bronze Paint



Ordering Information

IP- 2201 Left

IP- 2202 Right

Specify: Model Number and Finish

INTERMEDIATE PIVOT SETS	
IP-1900 Series	Mortised
IP-2200 Series	Slotted







International Door Closers, Inc.

COPYRIGHT 2021 INTERNATIONAL DOOR CLOSERS, INC

OFFSET PIVOT SETS

3/4" Offset for use with Aluminum Doors and Frames

- Oilite bronze bushing in top frame portion
- Case hardened, spring loaded pin in top door portion (case hardened fixed pin in Series 5000 top door portion)
- Full race ball bearing in bottom door portion
- Case hardened stud in floor/jamb portion (stainless steel stud in Series 5000 floor/jamb portion)
- 1/8" vertical adjustment
- For doors up to 125 lbs.
- Finishes Available:
AL - Baked Satin Aluminum Paint
BK - Baked Black Paint
DU - Baked Storefront Bronze Paint
Specify : Model Number and Finish

SERIES 2000	SERIES 3000	SERIES 4000	SERIES 5000	SERIES 6000	SERIES 7000
					
<p>OP-2700 (Non-Handed) Flush Door</p> <p>OP-2800 (Non-Handed) 1/8" Recessed Door</p>	<p>OP-3001 Left Flush Door</p> <p>OP-3002 Right Flush Door</p> <p>OP-3101 Left 1/8" Recessed Door</p> <p>OP-3102 Right 1/8" Recessed Door</p>	<p>OP-4001 Left Flush Door</p> <p>OP-4002 Right Flush Door</p>	<p>OP-5001 Left 1/8" Recessed Door</p> <p>OP-5002 Right 1/8" Recessed Door</p>	<p>OP-6001 Left 7/64" Recessed Door</p> <p>OP-6002 Right 7/64" Recessed Door</p>	<p>OP-7001 Left 1/8" Recessed Door</p> <p>OP-7002 Right 1/8" Recessed Door</p>
SEE CROSSOVER REFERENCE CHART ON NEXT PAGE					
Jackson 27 Jackson 28 Sun Valley All American Entrance Tech Rebco West	Tubelite* Arcadia All American Arch Aluminum Commercial Arch. Pacific Western Rebco Southwest Alum.	US Aluminum Sun Valley A Door MFG. Entrance Tech.	Aldora	Arch Aluminum Armalite Wells Aluminum	Kawneer

* Non-Adjustable Old Type

OFFSET PIVOT SETS	
OP-2000 Series	Flush or Recessed Door
OP-3000 Series	Flush or Recessed Door
OP-4000 Series	Flush Doors
OP-5000 Series	1/8" Recessed Doors
OP-6000 Series	7/64" Recessed Doors
OP-7000 Series	Kawneer Type

West: 800-544-4422 • East: 800-225-6737
www.intldoorclosers.com



CROSS REFERENCE CHART

JACKSON-SOMACA-CRL

JACKSON-SOMACA-CRL PIVOT CROSSOVER REFERENCE CHART

APPLICATION	"OLD" JACKSON PART NO.	"OLD" SOMACA PART NO.	JACKSON CRL PART NO.
Amarlite, Arch Aluminum, Rebco	41J40L628	3184462	OP40LHA
	41J40L313	3184363	OP40LHDU
	41J40R628	3184461	OP40RHA
	41J40R313	3184361	OP40RHDU
Arcadia, Arch Aluminum, Tubelite, Vistawall	41J30L628	3184430	OP30LHA
	41J26L313	3184330	OP30LHDU
	41J30R628	3184429	OP30RHA
	41J30R313	3184329	OP30RHDU
	41J31L628	3184432	OP31LHA
	41J31L313	3184332	OP31LHDU
	41J31R628	3184431	OP31RHA
	41J31R313	3184331	OP31RHDU
Atlas Arch	41J43L628	3184447	41J43L628
	41J43L313	3184347	41J43L313
	41J43R628	3184446	41J43R628
	41J43R313	3184346	41J43R313
Arch Aluminum	N/A	N/A	OP50LHA
	N/A	N/A	OP50LHDU
	N/A	N/A	OP50RHA
	N/A	N/A	OP50RHDU
Automatics, Besam	41J27628	3184423	OP27NHA
	41J27313	3184323	OP27NHDU
	41J28628	3184428	OP28NHA
	41J28313	3184328	OP28NHDU
Pittco, PPG	41J41L628	3184442	OP41LHA
	41J41L313	3184342	OP41LHDU
	41J41R628	3184441	OP41RHA
	41J41R313	3184341	OP41RHDU
U.S. Aluminum	41J25L628	3184421	41J25L628
	41J25L313	3184421	41J25L313
	41J25R628	3184420	41J25R628
	41J25R313	3184320	41J25R313
	41J26L628	3184427	41J26L628
	41J26L313	3184327	41J26L313
	41J26R628	3184426	41J26R628
	41J26R313	3184326	41J26R313
	41J34L628	3184460	OP34LHA
	41J34L313	3184360	OP34LHDU
	41J34R628	3184459	OP34RHA
	41J34R313	3184359	OP34RHDU

STAINLESS STEEL PIVOTS

CENTER HUNG PIVOTS

PIVOTS



CENTER HUNG PIVOTS

Pivot sets include top and bottom pivots. All center hung pivot sets are non-handed and double acting. Intermediate pivots are not used. Center hung pivots are not allowed with labeled doors. Door must be reduced on pivot edge. All sets are available in standard architectural finishes.

400 Series

Frame Portion Top Pivot



400-PF

- Mounting Holes Drilled & Tapped

Specify :
Model Number and Finish

400-PF1

- Mounting Holes Drilled & Countersunk

Dress Plate Frame Portion



400-PC

- For use with 400-PF1 Top Pivot
 - Finishes Available:
AL- Painted Satin Aluminum
DU- Painted Storefront Bronze
- Specify: Model Number and Finish

Door Portion Top Pivot



400-PD

CENTER HUNG PIVOTS	
400-PF	Mounting Holes Drilled & Tapped
400-PF1	Mounting Holes Drilled & Countersunk
400-PC	Dress Plate For 400-PF1
400-PD	Door Portion Top Pivot

West: 800-544-4422 • East: 800-225-6737
www.intldoorclosers.com



HEAVY DUTY

CONTINUOUS HINGES

ALUMINUM CONCEALED/MORTISE GEARED HINGES



CONCEALED/MORTISE LEAF HINGES

- **Any Door Material**
- **Heavy Duty** for high frequency 1 3/4" doors or heavy medium frequency doors up to 450lbs.
- **117FM** (Heavy Duty), **217FM** (Heavy Duty)

MODEL		LENGTH		SCREW COUNT		CLEARANCE
C (Clear Anodized)	D (Duro Anodized)	IN	CM	DOOR	JAMB	
117FMC-83	117FMD-83	83	210.8	19	19	5/16" (8mm) hinge side plus standard lockside clearance
117FMC-95	117FMD-95	95	241.3	21	21	
117FMC-120	117FMD-120	120	304.8	27	27	
217FMC-83	217FMD-83	83	210.8	19	19	
217FMC-95	217FMD-95	95	241.3	21	21	
217FMC-120	217FMD-120	120	304.8	27	27	

*Note: First 3 numbers = (Product #), FM = (Full Mortise), C or D = (Finish), 83, 95 & 120 = (Length)

FASTENERS: (Self-Tapping Screws)	<ul style="list-style-type: none"> • All fasteners as No. 12-24 x 1/16" Type C, FHUC • Heavy Duty Hinges - 10 required for each leaf
LENGTH OPTIONS:	83", 95" & 120"
DOOR REINFORCEMENT:	<ul style="list-style-type: none"> • None needed to 200 lbs • Use 16 gauge channel over 200 lbs
FRAME REINFORCEMENT:	<ul style="list-style-type: none"> • None needed to 200 lbs • Use 16 gauge channel over 200 lbs
FIRE RATING:	Up to 3 Hours
SPECIAL FEATURES:	<ul style="list-style-type: none"> • For new construction • For renovation with new door and / or frames • No mortising of doors or frames required • Will cover hinge cut outs in frames • Flush mount no inset • Frame and door leaf alignment ribs for proper hinge location
STANDARD FINISHES:	<ul style="list-style-type: none"> • C (Clear Anodized Aluminum), D (Duro Anodized Aluminum)
SPECIAL ORDER FINISHES:	<ul style="list-style-type: none"> • PW (Painted White), G (Gold Anodized Aluminum), BL (Black Anodized Aluminum)

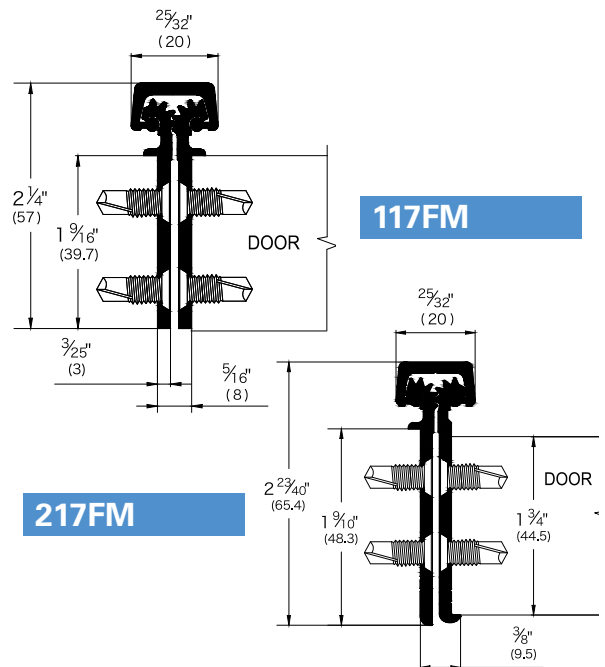

FULL CONCEALED ALUMINUM CONTINUOUS GEARED HINGES		
117FMC	C-Finish	Full Concealed
117FMD	D-Finish	Full Concealed
217FMC	C-Finish	Full Concealed, Mortise Geared Hinge
217FMD	D-Finish	Full Concealed, Mortise Geared Hinge

International Door Closers, Inc.

COPYRIGHT 2021 INTERNATIONAL DOOR CLOSERS, INC



HEAVY DUTY

CONTINUOUS HINGES

ALUMINUM FULL SURFACE GEARED HINGES

FULL SURFACE HINGES

- Any Door Material
- Heavy Duty for high frequency 1 3/4" doors or heavy medium frequency doors up to 450lbs.
- 317FS (Heavy Duty), 417FS (Heavy Duty), 517FS (Heavy Duty)

MODEL		LENGTH		SCREW COUNT		CLEARANCE
C (Clear Anodized)	D (Duro Anodized)	IN	CM	DOOR	JAMB	
317FSC-83	317FSD-83	83	210.8	19	19	1/32" (1mm) minimum recommended for hinge side plus standard lockside clearance
317FSC-95	317FSD-95	95	241.3	20	20	
317FSC-120	317FSD-120	120	304.8	26	26	
417FSC-83	417FSD-83	83	210.8	19	19	1/32" (1mm) minimum recommended for hinge side plus standard lockside clearance 1 5/8" (41mm) minimum frame face required plus 3/16" (5mm) rotational clearance
417FSC-95	417FSD-95	95	241.3	20	20	
417FSC-120	417FSD-120	120	304.8	26	26	
517FSC-83	517FSD-83	83	210.8	19	19	1/32" (1mm) minimum required between doors
517FSC-95	517FSD-95	95	241.3	20	20	
517FSC-120	517FSD-120	120	304.8	26	26	

*Note: First 3 numbers = (Product #), FS = (Full Surface), C or D = (Finish), 83, 95 & 120 = (Length)

FASTENERS: (Self-Tapping Screws)	FRAME PORTION <ul style="list-style-type: none"> • All fasteners as No. 12-24 x 1/16" Type C, FHUC - Heavy Duty Hinges - 10 required for each leaf DOOR PORTION <ul style="list-style-type: none"> • Thru-bolt 1/4-20 x 1 5/8" PCH - Heavy Duty Hinges - 6 required for each leaf • Shoulder bolt 1/4 - 20 x 1" PCH - Heavy Duty Hinges - 6 required • Pan Head Self Drilling No. 12 x 3/4" - Heavy Duty Hinges - 4 required
LENGTH OPTIONS:	83", 95" & 120"
DOOR REINFORCEMENT:	• None needed
FRAME REINFORCEMENT:	<ul style="list-style-type: none"> • None needed to 200 lbs • Use 16 gauge channel over 200 lbs
FIRE RATING:	Up to 3 Hours
SPECIAL FEATURES:	<ul style="list-style-type: none"> • Replacement for existing doors and frames • 7/8" minimum frame • 1/16" inset
STANDARD FINISHES:	<ul style="list-style-type: none"> • C (Clear Anodized Aluminum), D (Duro Anodized Aluminum)
SPECIAL ORDER FINISHES:	<ul style="list-style-type: none"> • PW (Painted White), G (Gold Anodized Aluminum), BL (Black Anodized Aluminum)

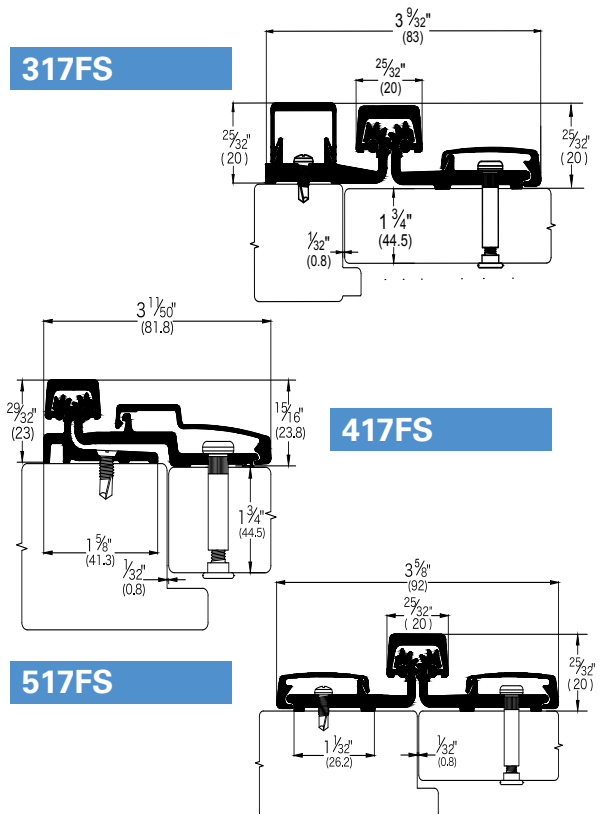

FULL SURFACE ALUMINUM CONTINUOUS GEARED HINGES		
317FSC	C-Finish	Full Surface
317FSD	D-Finish	Full Surface
417FSC	C-Finish	Full Surface
417FSD	D-Finish	Full Surface
517FSC	C-Finish	Full Surface
517FSD	D-Finish	Full Surface

West: 800-544-4422 • East: 800-225-6737

www.intldoorclosers.com



HEAVY DUTY CONTINUOUS HINGES

ALUMINUM HALF SURFACE GEARED HINGES



HALF SURFACE HINGES

- Any Door Material
- Heavy Duty for high frequency 1 3/4" doors or heavy medium frequency doors up to 450lbs.
- 617HS (Heavy Duty)

MODEL		LENGTH		SCREW COUNT		CLEARANCE
C (Clear Anodized)	D (Duro Anodized)	IN	CM	DOOR	JAMB	
617HSC-83	617HSD-83	83	210.8	19	19	5/16" (8mm) hinge side plus standard lockside clearance
617HSC-95	617HSD-95	95	241.3	20	20	
617HSC-120	617HSD-120	120	304.8	26	26	

*Note: First 3 numbers = (Product #), FS = (Half Surface), C or D = (Finish), 83, 95 & 120 = (Length)

FASTENERS: (Self-Tapping Screws)	FRAME PORTION <ul style="list-style-type: none"> • All fasteners as No. 12-24 x 1/16" Type C, FHUC - Heavy Duty Hinges - 10 required for each leaf DOOR PORTION <ul style="list-style-type: none"> • Thrubolt 1/4-20 x 1 5/8" PCH - Heavy Duty Hinges - 6 required for each leaf • Shoulder bolt 1/4 - 20 x 1" PCH - Heavy Duty Hinges - 6 required • Pan Head Self Drilling No. 12 x 3/4" - Heavy Duty Hinges - 4 required
LENGTH OPTIONS:	83", 95" & 120"
DOOR REINFORCEMENT:	• None needed
FRAME REINFORCEMENT:	<ul style="list-style-type: none"> • None needed to 200 lbs • Use 16 gauge channel over 200 lbs
FIRE RATING:	Up to 3 Hours
SPECIAL FEATURES:	<ul style="list-style-type: none"> • For new construction • For renovation with new door and / or frames • No mortising of doors or frames required • Will cover hinge cut outs in frames • Flush mount no inset • Frame and door leaf alignment ribs for proper hinge location
STANDARD FINISHES:	<ul style="list-style-type: none"> • C (Clear Anodized Aluminum), D (Duro Anodized Aluminum)
SPECIAL ORDER FINISHES:	<ul style="list-style-type: none"> • PW (Painted White), G (Gold Anodized Aluminum), BL (Black Anodized Aluminum)

617HS

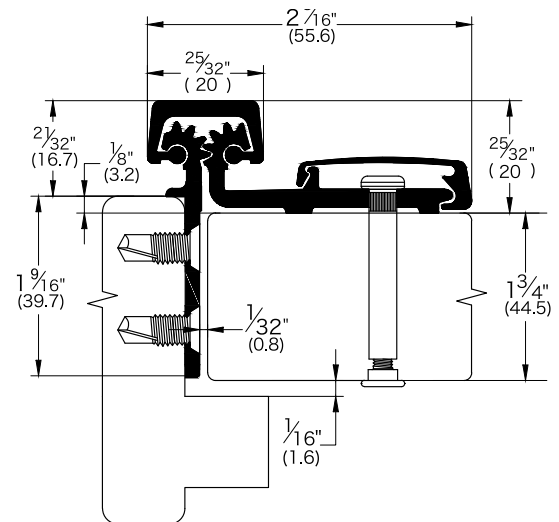

HALF SURFACE ALUMINUM CONTINUOUS GEARED HINGES		
617HSC	C-Finish	Full Surface
617HSD	D-Finish	Full Surface

International Door Closers, Inc.

COPYRIGHT 2021 INTERNATIONAL DOOR CLOSERS, INC

CROSS REFERENCE CHART

CONTINUOUS GEAR HINGES

CONTINUOUS GEAR HINGES CROSS REFERENCE CHART												
TYPE	IDC	ABH	PBB	PHOENIX	PRECISION	NGP	ROTON	SELECT	PEMKO	MCKINNEY	STANLEY	IVES
Full Concealed	117FM	A110HD	CG31	GHHD112	GHHD112	HD1100	780-112HD	SL11 HD	FMSLF-HD1	MCK12HD	661HD	112HD
Full Concealed Mortise Leaf	217FM	A240HD	CG31L	GHHD224	GHHD224	HD2400	780-224HD	SL24 HD	FM-HD1	MCK25HD	662HD	224HD
Full Surface	317FS	A570HD	CG33N	GHHD157	GHHD157	HD5700	780-157HD	SL57 HD	FSCP-HD1	MCK58HD	664HD	157XY
Full Surface	417FS	A210HD	CG33C	GHHD210	GHHD210	HD2100	780-210HD	SL21 HD	FS-HD1	MCK22HD	665HD	210HD
Full Surface	517FS	A571HD	-	GHHD057	GHHD057	-	780-057HD	-	-	-	-	-
Half Surface	617HS	A540HD	CG34	-	-	HD5400	780-054HD	SL54 HD	HS-HD1	MCK54HD	663HD	054HD

117FM

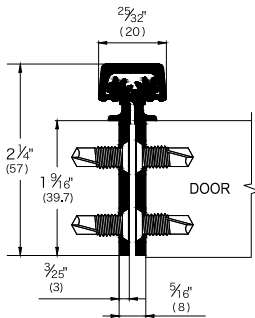

317FS

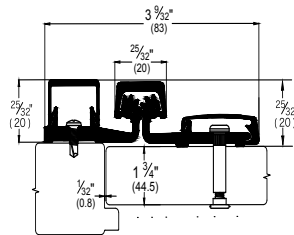

517FS

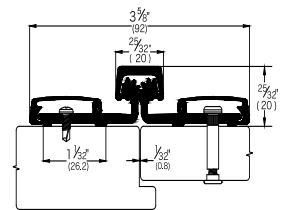

217FM

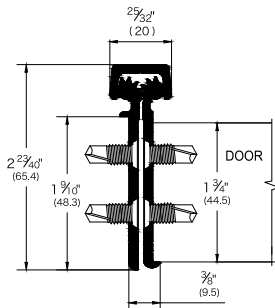

417FS

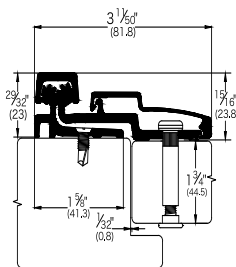

617HS

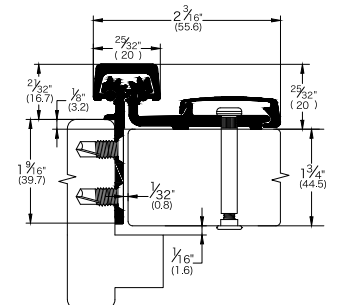

West: 800-544-4422 • East: 800-225-6737
www.intldoorclosers.com



EXIT DEVICE
5000 SERIES
 GRADE 2

International Door Closers IDC 5000 Series Exit Devices meet the Life and Fire Safety Codes as prescribed by UL and ANSI / BHMA 156.3 standards. These durable devices are designed for both standard and commercial applications. The 5000 Series were tested and approved by Underwriters Laboratories (UL, USA and ULC, Canada) and listed to comply with UL 10C, and Uniform Building Code Standard 7-2, "Fire Test of Door Assemblies" (1997).



FEATURES

- All devices are non-handed design
- Auxiliary guarded latch deadlocks latch bolt automatically locks when the door is closed
- High shock-resistant latching mechanical design for protection from vandalism
- All inside components are made of high rust-resistant alloy or heavy electroplated steel
- Baked powder coating, electroplated or architectural base finishes are used on all exposed surfaces
- Outside trims are provided by rose and escutcheon lever or knob in a variety of styles
- All trim, features a through-bolted design to the devices that allow easy installation but not to compromise on security
- With a dogging mechanism, users have a choice of hex-key or cylinder operated design for a positive push-pull door action during peak traffic time

RIM TYPE	DESCRIPTION	US28 (689)	US20A (690)
5510S	Panic Rated, 36"	Available	Available
5610S	Panic Rated, 36", Narrow Design	Available	Available
5510S	Panic Rated, 48"	Available	Available
5610S	Panic Rated, 48", Narrow Design	Available	Available
5510F	Fire Rated, 36"	Available	Available
5610F	Fire Rated, 36", Narrow Design	Available	Available
5510F	Fire Rated, 48"	Available	Available
5610F	Fire Rated, 48", Narrow Design	Available	Available
SURFACE VERTICAL ROD TYPE			
5530S	Panic Rated, 36"	Available	Available
5630S	Panic Rated, 36", Narrow Design	Available	Available
5530S	Panic Rated, 48"	Available	Available
5630S	Panic Rated, 48", Narrow Design	Available	Available
5530F	Fire Rated, 36"	Available	Available
5630F	Fire Rated, 36", Narrow Design	Available	Available
5530F	Fire Rated, 48"	Available	Available
5630F	Fire Rated, 48", Narrow Design	Available	Available

International Door Closers, Inc.

COPYRIGHT 2021 INTERNATIONAL DOOR CLOSERS, INC



5510S Panic Rim Exit Device

5510F Fire Rim Exit Device



5530S Panic SVR Exit Device

5530F Fire SVR Exit Device



5610S Narrow Design

Panic Rim Exit Device



5630S Narrow Design

Panic SVR Exit Device

5510 SERIES RIM EXIT DEVICE
5530 SERIES SVR EXIT DEVICE

These two series models are wide stile design, UL listed Panic Hardware or Fire Exit Hardware.

Rim Type- Ideally suited for:

- Any single exterior doors
- Any panic or fire rated interior single door and all exit doors in factories, hospitals, apartments, office buildings
- Indoor parking lots

SVR Type- Ideally suited for:

- Any pairs of emergency exit doors
- Pairs of doors in cross-corridors
- Double egress applications
- Passage doors in hospitals, factories or any public buildings

5000 SERIES STRIKES (CALL FOR AVAILABILITY)	
531	Strike Shim for 5510/5610
532	Panic Rim Strike for 5510/5610
533	Fire Rim Strike for 5510
534	Top Strike for 5630
537	Bottom Strike for 5630

5610 NARROW DESIGN PANIC RIM DEVICE
5630 NARROW DESIGN PANIC SVR DEVICE

These two models are narrow stile design, UL listed Panic Hardware

Rim Type and SVR Type

Both Types- Ideally suited for:

- Glass door
- Aluminum entrance doors
- Passage doors
- Full glass doors in stores, resorts and hotels

5000 SERIES OPTIONS (CALL FOR AVAILABILITY)	
FL001	Fire Latch Bolt
CD	Keyed Cylinder Dogging
426	Rim Cylinder
526	Mortise Cylinder
208	Interchangeable Core, Mortise Cylinder
308	Interchangeable Core, Rim Cylinder

West: 800-544-4422 • East: 800-225-6737
www.intldoorclosers.com

RIM EXIT DEVICES

WIDE DESIGN EXIT DEVICES

MODEL 5510S PANIC-RATED RIM EXIT DEVICE - For wide design and flush doors use
MODEL 5510F FIRE-RATED RIM EXIT DEVICE - For wide design and flush doors use



Application

- For use on single or double doors with mullion (Fire rated device must use on 4' x 8' single or up to an 8' x 8' double fire labeled doors).
- Fits for 1 3/4" (44mm) thick standard RHR or LHR hollow metal doors & wood doors Other than standard an 1 3/4" is available but specify door thickness when ordering.
- Minimum Stile width: 3 1/2" (90mm)

Specifications

Device Head Cover	Stainless Steel, nonferrous alloy
Chassis	Steel plated
Mechanism Housing	Steel or Stainless Steel
Push Bar	Steel or Stainless Steel
End Cap	Steel or Stainless Steel
Latch Bolt	100% Stainless Steel, dead locking type with an 11/16" throw
Deadlocking Latch	100% Stainless Steel with 5/8" (16mm) throw
Strikes	531 & 532 Rim (panic rated) 533 Rim (fire rated)
Handing	Non-handed
Mounting Fasteners	Machine screws furnished standard Sex Nut & Bolt (SNB) are required for wood doors. Order SNB separately including standard.
Dogging*	Hex key dogging standard (Allen-type key furnished)
Dogging Options	Cylinder dogging or less dogging
Finish	US28 (689) and US20A (690)
Dimension	See Spec. Sheet
Device Length	See Spec. Sheet
UL Listed	For Panic Hardware, see model 500SA For Fire Exit Hardware, see model 510AF



531 Strike Shim

Furnished with 532 Strike together made if steel and is plated. This shim is 1/8" thick and is used to prepare doors with a 1/2" stop. This will correct the distance between the device latch and the surface. If the frame has a 5/8" stop a shim is not needed.

532 Panic Rim Strike

Surface applied standard on 5000 Series panic rim exit devices. Stainless Steel with a plated roller.

533 Fire Rim Strike

Surface applied. Standard on 5000 Series fire rim devices. It is 100% stainless steel including a roller.

5000 SERIES STRIKES (CALL FOR AVAILABILITY)	DESCRIPTION
531	Strike Shim for 5510/5610
532	Panic Rim Strike for 5510/5610
533	Fire Rim Strike for 5510
534	Top Strike for 5630
537	Bottom Strike for 5630

*Fire rated SVR device has no mechanical dogging. (Dogging device is not permitted on fire-rated exit device)

International Door Closers, Inc.

COPYRIGHT 2021 INTERNATIONAL DOOR CLOSERS, INC

SURFACE VERTICAL ROD EXIT DEVICES

WIDE DESIGN EXIT DEVICES

MODEL 5530S PANIC-RATED SVR EXIT DEVICE - For wide design and flush doors use

MODEL 5530F FIRE-RATED SVR EXIT DEVICE - For wide design and flush doors use

Application

- For use on all single doors or double doors where two-point latch is desirable (inactive leaf of double door). Fire rated device must use on 4' x 8' single or 8' x 8' double fire labeled doors.
- Fits for 1 3/4" (44mm) thick standard non-handed hollow metal and wood doors, other than standard 1 3/4" is available but specify door thickness when ordered.
- Minimum Door Stile width: 3 1/2" (90mm)



534 Top Strike

Applied to surface of stop. Hardened steel and plated.



537 Bottom Strike

Applied to surface of floor. Nonferrous alloy and plated.

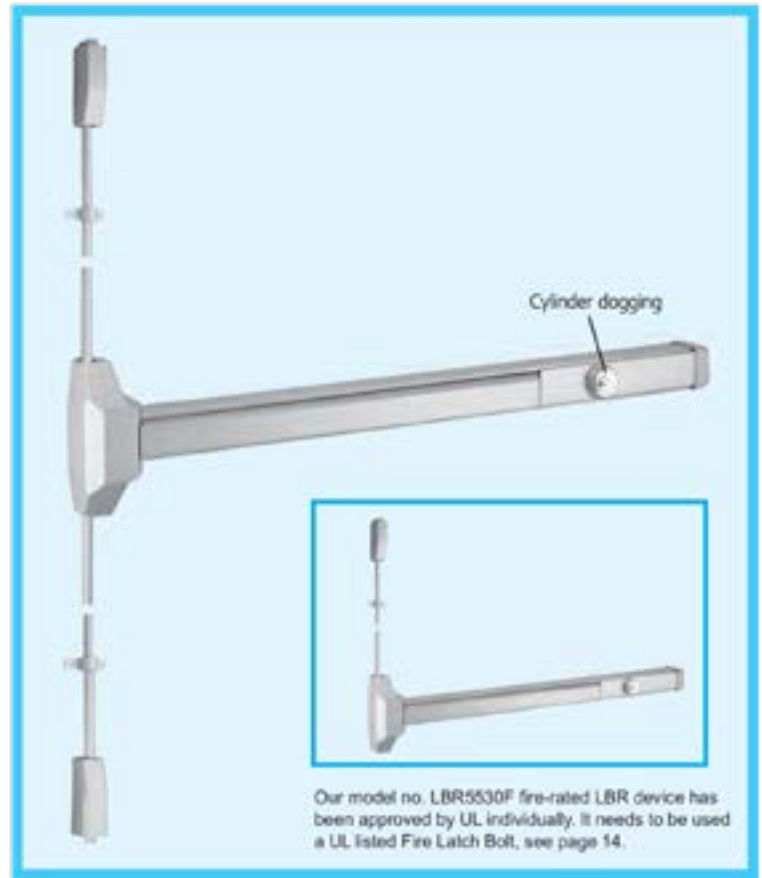

Our model no. LBR5530F fire-rated LBR device has been approved by UL individually. It needs to be used a UL listed Fire Latch Bolt, see page 14.

Specifications

Device Head Cover	Stainless Steel, nonferrous alloy
Chassis	Steel, stainless steel
Mechanism Housing	Steel or Stainless Steel
Push Bar	Steel or Stainless Steel
End Cap	Steel or Stainless Steel
Latch Bolt	100% stainless steel, 1/2" (13mm) throw
Latch Case Covers	Steel, stainless steel
Vertical Rods	Tubular aluminum with rod guides
Strikes	Top 534, Bottom 537
Handing	Non-handed

Mounting Fasteners	Machine screws furnished standard, Sex Nut and Bolt (SNB) are required to use for wood doors. Order SNB separately.
Dogging*	Hex key dogging standard (Allen-type key furnished)
Dogging Options	Cylinder dogging or Less dogging
Finish	US28 (689) and US20A (690)
Dimension	See Spec. Sheet
Device Length	See Spec. Sheet
UL Listed	For Panic Hardware, see model 900SA and Fire Exit Hardware see model 917A

*Fire rated SVR device has no mechanical dogging. (Dogging device is not permitted on fire-rated exit device)

West: 800-544-4422 • East: 800-225-6737
www.intldoorclosers.com

RIM EXIT DEVICES

NARROW DESIGN EXIT DEVICES

MODEL 5610S PANIC-RATED RIM EXIT DEVICE - For narrow design exit doors made from Aluminum, Metal (HM) or Wood



Application

- For use on single doors or double doors with mullion (Fire rated device up to 4'x8' single or 8'x8' double fire labeled doors.
- Fits for 1 3/4" (44mm) thick standard non-handed or hollow metal or wood doors, other than standard 1 3/4" is available, specify door thickness.
- Minimum Stile width : 2 1/2" (63mm)



531 Strike Shim

Furnished with 532 Strike. This shim is 1/8" thick for prepared doors with 1/2" stop. It is used to obtain correct distance between the latch and the surface applied strike, when the stop is 1/2" high. If the frame has a 5/8" stop the shim is not required. Strike shim is steel and plated.



532 Panic Rim Strike

Surface applied. Standard on 5000 Series panic rim exit devices. Stainless steel with a plated roller.

5000 SERIES STRIKES (CALL FOR AVAILABILITY)	DESCRIPTION
531	Strike Shim for 5510/5610
532	Panic Rim Strike for 5510/5610
533	Fire Rim Strike for 5510
534	Top Strike for 5630
537	Bottom Strike for 5630

Specifications

Device Head Cover	Stainless Steel, nonferrous alloy
Chassis	Steel plated
Mechanism Housing	Steel, plated
Push Bar	Steel or Stainless Steel
End Cap	Steel or Stainless Steel
Latch Bolt	100% stainless steel, deadlocking type, 11/16" (17mm) throw
Deadlocking Latch	100% stainless steel with 5/8" throw
Strikes	531 & 532 Rim type
Handing	Non-handed
Mounting Fasteners	Machine screws furnished standard, Sex Nut and Bolt (SNB) are required to use for wood doors. Order SNB separately
Dogging*	Hex key dogging standard (Allen-type key furnished)
Dogging Options	Cylinder dogging or less dogging
Finish	US28 (689) and US20A (690)
Dimension	See Spec. Sheet
Device Length	See Spec. Sheet
UL Listed	For Panic Hardware, see model 500SA For Fire Exit Hardware, see model 510AF

*Fire rated SVR device has no mechanical dogging. (Dogging device is not permitted on fire-rated exit device)

MODEL 5630S PANIC-RATED SVR EXIT DEVICE - For narrow design and flush doors use

Application

- For use on all single or double doors where two-point latch is desirable (inactive leaf of double door in specialty). Fire rated device must be use on 4' x 8" single or 8' x 8" double fire labeled doors (max. size).
- Fits for 1 3/4" (44mm) thick standard RHR or LHR hollow metal door and wood doors, other than standard 1 3/4" is available but specify door thickness when ordering.
- Minimum Door Stile width: 2 1/2" (63mm).



534 Top Strike

Applied to surface of stop.
Hardened steel and plated.



537 Bottom Strike

Applied to surface of floor.
Nonferrous alloy and plated.



Specifications

Device Head Cover	Stainless Steel, nonferrous alloy
Chassis	Steel, plated
Mechanism Housing	Steel or Stainless Steel
Push Bar	Steel or Stainless Steel
End Cap	Steel or Stainless Steel
Latch Bolt	100% stainless steel, 1/2" (13mm) throw
Latch Case Covers	Steel, stainless steel
Vertical Rods	Tubular aluminum with rod guides
Strikes	Top 534, Bottom 537
Handing	Non-handed

Mounting Fasteners	Machine screws furnished standard, Sex Nut and Bolt (SNB) are required to use for wood doors. Order SNB separately.
Dogging*	Hex key dogging standard (Allen-type key furnished)
Dogging Options	Cylinder dogging or Less dogging
Finish	US28 (689) and US20A (690)
Dimension	See Spec. Sheet
Device Length	See Spec. Sheet
UL Listed	For Panic Hardware

*Fire rated SVR device has no mechanical dogging. (Dogging device is not permitted on fire-rated exit device)



GRADE 1 • DESIGNED FOR ALUMINUM AND HOLLOW METAL DOORS

7100-G1 SERIES

CONCEALED VERTICAL ROD (CVR)

FEATURES

- Underwriter’s Laboratories Inc. Listed Panic Hardware
- For use with narrow, medium and wide stile Aluminum doors
- Non-handed, Field Reversible for LHRB or RHRB doors
- Outside Unlatching and Dogging by Cylinder Key or Dogging by Hex Key in TouchBar
- Top Steel Toggle Latch and Bottom Steel Rod Latch Bolt
- Units use Standard Mortise Cylinder with MS Type Cam and M P-6182 Cylinder Mounting Pad
- Standard Units for 36” and 48” door widths (cut bar to fit) and up to 84” in height
- Can be used on 30” wide doors

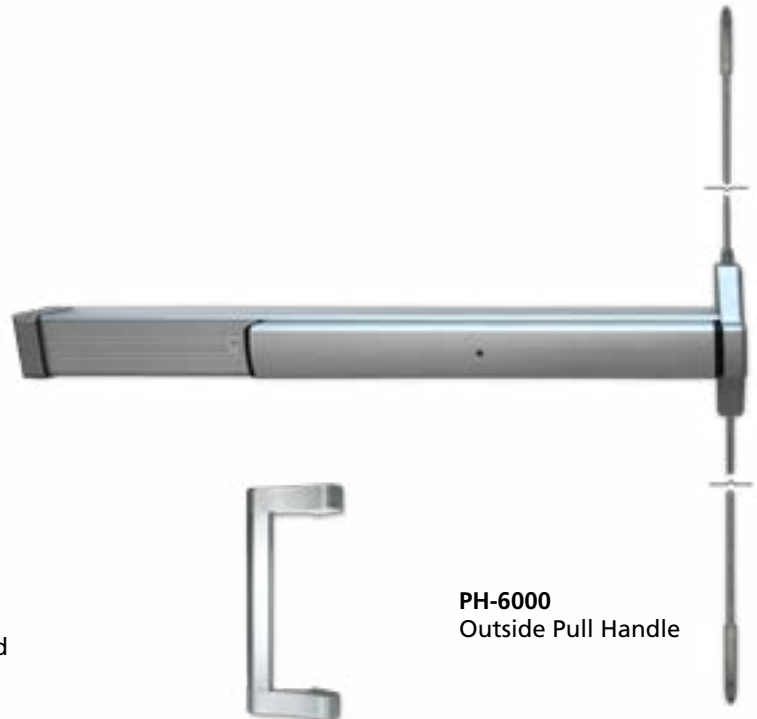

PH-6000
Outside Pull Handle



FINISHES

- AL - ALUMINUM- Anodized extruded Aluminum with Bakexd Aluminum Painted Cover Caps
- DU- STOREFRONT BRONZE- Bronze Anodized extruded Aluminum with Baked Storefront Bronze Painted Cover Caps
- WARRANTY: Refer to inside front cover
- US AND FOREIGN PATENTS



MP-6000
Pull Handle Mounting Plate for Metal Doors



MP-6182
Cylinder Mounting Pad with Locking Ring



CZ-1001
Mortise Cylinder

International Door Closers, Inc.

COPYRIGHT 2021 INTERNATIONAL DOOR CLOSERS, INC

7300-G1 SERIES

RIM PANIC

FEATURES

- Underwriter's Laboratories Inc. Listed
- Panic Hardware
- For use with narrow, medium and wide stile
Aluminum doors, Hollow Metal or
Wood Doors
- Non-handed, for LHRB or RHRB doors
- Latch Bolt throw 5/8"
- Dogging by Hex Key in Touch Bar
- Outside Unlatching with standard
Rim Cylinder
- Standard units for 36" and 48" door widths
(cut bar to fit)
- Can be used on 30" wide doors



FINISHES

AL - ALUMINUM- Anodized extruded Aluminum
with Baked Aluminum Painted Cover Caps

DU- STOREFRONT BRONZE- Bronze Anodized
extruded Aluminum with Baked Storefront Bronze
Painted Cover Caps

WARRANTY: Refer to inside front cover



PH-6000
Outside Pull Handle



MP-6000 Pull Handle
Mounting Plate for
Wood or Metal Doors

7100-G1/7300-G1 SERIES GRADE 1 PARTS AND ACCESSORIES	
PH-6000	Outside Pull Handle
MP-6000	Pull Handle Mounting Plate
MP-6182	Cylinder Mounting Pad with Locking Ring
CZ-1001	Mortise Key Cylinder (Zinc) with 1 Key & Ring
RZ-1003	Rim Cylinder (Zinc) with 2 Keys & Ring
ST-6312	Standard Surface Roller Strike
RE-6112	12" Rod Extender with Coupler
RE-6124	24" Rod Extender with Coupler
SN12-175	12-24 x 1.75 Sex Nut



RZ-1003 Rim Cylinder

Finishes Available:

AL - Anodized Satin Aluminum

BK - Anodized Black

DU - Anodized Bronze

Specify: Finish



GRADE 1 • ARCHITECTURAL TYPE • EXIT DEVICES

8000 SERIES

SERIES HEAVY-DUTY MODELS

FEATURES

- All devices are non-handed design
- Slight pressure on device touch bar will retract latch(s) for immediate exit
- Auxiliary guarded latch deadlocks latch bolt automatically when door is closed
- High shock-resistant latching mechanical design for protection from vandalism
- All inside components are made of high rust-resistant alloy or heavily electroplated steel
- Anti-fading, electroplated or architectural base material finishes on all exposed surfaces are available
- With a dogging mechanism, users have a choice of hex-key or cylinder operated for positive push-pull action at peak traffic time. This dogging device will also help by increasing the life of the exit device (panic label only).
- The exit devices are available in the following finishes: US32D and US10B.



IDC 8000 Series Exit Devices are heavy duty and designed for heavy traffic applications. The devices are Underwriters Laboratory (UL, USA and ULC, Canada) listed for Panic Exit Hardware or Fire Exit Hardware, and are certified to ANSI A156.3-2001 Grade 1.



Rim Exit Device



Surface Exit Device

The IDC 8000 Series is a heavy-duty push bar exit device which has two external surface styles: Smooth Device Body and Grooved Device Body. The 8600 Series are smooth device body. The 8700 and 8800 Series are grooved device body. These two styles provide a wide selection of style options for architects and building owners.

International Door Closers, Inc.

COPYRIGHT 2021 INTERNATIONAL DOOR CLOSERS, INC

8000 SERIES HEAVY DUTY GRADE 1				
RIM TYPE	DESCRIPTION	US26	US10B	US32D
8710S	Panic Rated, 36", Narrow Design	Available	Available	Call for Availability
8810S	Panic Rated, 36"	Available	Available	Call for Availability
8710S	Panic Rated, 48", Narrow Design	Available	Available	Call for Availability
8810S	Panic Rated, 48"	Available	Available	Call for Availability
8710F	Fire Rated, 36", Narrow Design	Available	Available	Call for Availability
8810F	Fire Rated, 36"	Available	Available	Call for Availability
8710F	Fire Rated, 48", Narrow Design	Available	Available	Call for Availability
8610F/8810F	Fire Rated, 48"	Available	Available	Call for Availability
SURFACE VERTICAL ROD TYPE				
8730S	Panic Rated, 36", Narrow Design	Available	Available	Call for Availability
8630S/8830S	Panic Rated, 36"	Available	Available	Call for Availability
8730S	Panic Rated, 48", Narrow Design	Available	Available	Call for Availability
8630S/8830S	Panic Rated, 48"	Available	Available	Call for Availability
8730F	Fire Rated, 36", Narrow Design	Available	Available	Call for Availability
8630F/8830F	Fire Rated, 36"	Available	Available	Call for Availability
8730F	Fire Rated, 48", Narrow Design	Available	Available	Call for Availability
8630F/8830F	Fire Rated, 48"	Available	Available	Call for Availability
CONCEALED VERTICAL ROD TYPE				
8750S	Panic Rated, 36", Narrow Design	Available	Available	Call for Availability
8650S/8850S	Panic Rated, 36"	Available	Available	Call for Availability
8750S	Panic Rated, 48", Narrow Design	Available	Available	Call for Availability
8650S/8850S	Panic Rated, 48"	Available	Available	Call for Availability
8750F	Fire Rated, 36", Narrow Design	Available	Available	Call for Availability
8650F/8850F	Fire Rated, 36"	Available	Available	Call for Availability
8750F	Fire Rated, 48", Narrow Design	Available	Available	Call for Availability
8650F/8850F	Fire Rated, 48"	Available	Available	Call for Availability
LESS BOTTOM ROD SURFACE VERTICAL ROD TYPE				
LBR8630S/8830S	Panic Rated, 36"	Available	Available	Call for Availability
LBR8630S/8830S	Panic Rated, 48"	Available	Available	Call for Availability
LBR8630F/8830F	Fire Rated, 36"	Available	Available	Call for Availability
LBR8630F/8830F	Fire Rated, 48"	Available	Available	Call for Availability

- Call for US26D Availability
- Call for Smooth or Grooved Available Device Options

MODEL 8710S NARROW PANIC-RATED RIM EXIT DEVICE
MODEL 8710F NARROW FIRE-RATED RIM EXIT DEVICE



IDC 8500 / 8700 Series heavy-duty narrow design Panic and Fire-Rated Hardware are designed for contemporary glass, aluminum, wood and metal doors.

Certification

- **UL/cUL Listed:** UL listed as Panic Exit Hardware or 3-hour Fire Exit Hardware
- **ANSI Certified:** Devices are ANSI A156.3 – 2001 Grade 1

Application

- 8519S / 8710S narrow design are used for framed glass or flush door applications. 87610F narrow design rim devices can be used for single doors with a 2-19/32" minimum stile and up to 4' X 8' or 8' X 8' pairs of doors with a mullion.
- The exit devices are available in the following finishes: US32D and US10B.

Specifications

Device Lengths	<ul style="list-style-type: none"> • Standard (36"): 33-15/32" (850mm) • Long (48"): 44-3/4" (1137mm)
Door Widths	<ul style="list-style-type: none"> • 36" - For 29" to 36" (736mm to 914mm) doors • 48" - For 33" to 48" (838mm to 1219mm) doors
Minimum Stile Width	2-19/32" (66mm)
Latch Bolt	3/4" (19mm) throw, deadlocking design
Strikes	801 (panic), 802 (fire)
Doggin Kit	<ul style="list-style-type: none"> • Panic device - Hex key dogging (RD) standard • Fire device - No mechanical dogging (ND)
Dogging Options	<ul style="list-style-type: none"> • Cylinder Dogging (CD) • Less Dogging (LD)
Mounting Fasteners	<ul style="list-style-type: none"> • Panic device - Machine screws furnished standard • Fire device - Sex nuts and bolts (SNB) supplied standard • Optional SNB are available for device, order separately
Mounting Height	Device center line from finished floor is 40" (1016mm) standard
Door Opening Height	Device centerline from finished floor is 40" (1016mm) standard
Projection	Pushbar Neutral: 3-1/16" (78mm), Pushbar Depressed: 2-19/32" (66mm)

MODEL 8730S NARROW DESIGN PANIC-RATED RIM EXIT DEVICE
MODEL 8730F NARROW DESIGN FIRE-RATED RIM EXIT DEVICE



Certification

- **UL/cUL Listed:** Panic Exit Hardware or 3-hour Fire Exit Hardware
- **ANSI Certified:** Devices are ANSI A156.3 – 2001 Grade 1

Application

- Narrow design Panic SVR exit devices are used for aluminum frame full glass doors or narrow stile aluminum door applications. The narrow design Fire SVR exit devices are use for wide stile pairs of metal or wood doors up to 8' x 8' (2438mm x 2438mm).
- The exit devices are available in the following finishes: US32D and US10B.

Specifications

Device Lengths	<ul style="list-style-type: none"> • Standard (36"): 33-15/32" (850mm) • Long (48"): 44-3/4" (1137mm)
Door Widths	<ul style="list-style-type: none"> • 36" - For 29" to 36" (736mm to 914mm) doors • 48" - For 33" to 48" (838mm to 1219mm) doors
Minimum Stile Width	2-19/32" (66mm)
Latch Bolt	<ul style="list-style-type: none"> • Top latch - 5/8" (16mm) throw, can be deadlocked automatically • Bottom latch - 5/8" (16mm) throw, held retracted during door swing
Strikes	<ul style="list-style-type: none"> • Top: 812 (Panic), 822 (Fire). • Bottom: 815 (Panic), 825 (Fire)
Doggin Kit	<ul style="list-style-type: none"> • Panic device - Hex key dogging (RD) standard • Fire device - No mechanical dogging (ND)
Dogging Options	<ul style="list-style-type: none"> • Cylinder Dogging (CD) • Less Dogging (LD)
Mounting Fasteners	<ul style="list-style-type: none"> • Panic device - Machine screws furnished for device standard SNB furnished for top & bottom latches • Fire device - Sex nuts and bolts (SNB) supplied standard SNB are required for wood doors, supplied standard
Mounting Height	Device centerline from finished floor is 40" (1016mm) standard
Door Opening Height	Standard door height is 7' (Optional 8' door is available)
Vertical Rods	<ul style="list-style-type: none"> • 1/2" (13mm) diameter tubular with rod guides • Top rod has two pieces to connect for accommodating 7' or 8' doors • Bottom rod is one piece with a length of 31-1/4" (794mm)
Projection	Pushbar Neutral: 3-1/16" (78mm) and Pushbar Depressed: 2-19/32" (66mm)

MODEL 8750S NARROW DESIGN PANIC-RATED RIM CVR EXIT DEVICE
MODEL 8750F NARROW DESIGN FIRE-RATED RIM CVR EXIT DEVICE



Specifications

Device Lengths	<ul style="list-style-type: none"> Standard (36"): 33-15/32" (850mm) Long (48"): 44-3/4" (1137mm)
Door Widths	<ul style="list-style-type: none"> 36" - For 29" to 36" (736mm to 914mm) doors 48" - For 33" to 48" (838mm to 1219mm) doors
Minimum Stile Width	2-19/32" (66mm)
Latch Bolt	<ul style="list-style-type: none"> Top latch - 5/8" (16mm) throw, can be deadlocked automatically Bottom latch - 5/8" (16mm) throw, held retracted during door swing
Strikes	<ul style="list-style-type: none"> Top: 812 (Panic), 823 (Fire). Bottom: 815 (Panic), 825 (Fire)
Doggin Kit	<ul style="list-style-type: none"> Panic device - Hex key dogging (RD) standard Fire device - No mechanical dogging (ND)
Dogging Options	<ul style="list-style-type: none"> Cylinder Dogging (CD) Less Dogging (LD)
Mounting Fasteners	<ul style="list-style-type: none"> Panic device - Machine screws furnished for device standard SNB furnished for top & bottom latches Fire device - Sex nuts and bolts (SNB) supplied standard SNB are required for wood doors, supplied standard
Mounting Height	Device centerline from finished floor is 40" (1016mm) standard
Door Opening Height	Standard door height is 7' (Optional 8' door is available)
Vertical Rods	<ul style="list-style-type: none"> 1/2" (13mm) diameter tubular with rod guides Top rod has two pieces to connect for accommodating 7' or 8' doors Bottom rod is one piece with a length of 31-1/4" (794mm)
Projection	Pushbar Neutral: 3-1/16" (78mm) and Pushbar Depressed: 2-19/32" (66mm)

Certification

- **UL/cUL Listed:** Panic Exit Hardware or 3-hour Fire Exit Hardware
- **ANSI Certified:** Devices are ANSI A156.3 – 2001 Grade 1

Application

- Narrow design Panic CVR exit devices are used for the framed glass doors or hollow metal door applications. The narrow design Fire CVR exit devices are used with wide stile pairs of steel doors up to 8' x 8' (2438mm x 2438mm).
- The exit devices are available in the following finishes: US32D and US10B.

MODEL 8610S/8810S PANIC-RATED RIM EXIT DEVICE
MODEL 8610F/8810F FIRE-RATED RIM EXIT DEVICE



- MODEL 8610S/8810S PANIC-RATED RIM EXIT DEVICE
- MODEL 8610F/8810F FIRE-RATED RIM EXIT DEVICE

The IDC 8600 and 8800 Series have a full line of heavy-duty wide design Panic and Fire-rated Hardware. This series offer durability, safety and meet the security demand and access control needs of today.

Certification

- **UL/cUL Listed:** UL listed as Panic Exit Hardware or 3-hour Fire Exit Hardware
- **ANSI Certified:** Devices are ANSI A156.3 – 2001 Grade 1

Application

- 8610S/8810S rim exit devices are used for all types of single double doors with mullion.
- 8610F/8810F rim exit devices are used for UL listed fire labeled single doors up to 4' x 8' (1219mm x 2438mm) or 8' x 8' (2438mm x 2438mm) double doors with mullion.
- The exit devices are available in the following finishes: US32D and US10B.

Specifications

Device Lengths	<ul style="list-style-type: none"> • Standard (36"): 33-15/32" (850mm) • Long (48"): 44-3/4" (1137mm)
Door Widths	<ul style="list-style-type: none"> • 36" - For 29" to 36" (736mm to 914mm) doors • 48" - For 33" to 48" (838mm to 1219mm) doors
Minimum Stile Width	4-1/4" (107mm)
Latch Bolt	3/4" (19mm) throw, deadlocking design
Strikes	801 (panic), 802 (fire)
Doggin Kit	<ul style="list-style-type: none"> • Panic device - Hex key dogging (RD) standard • Fire device - No mechanical dogging (ND)
Dogging Options	<ul style="list-style-type: none"> • Cylinder Dogging (CD) • Less Dogging (LD)
Mounting Fasteners	<ul style="list-style-type: none"> • Panic device - Machine screws furnished standard • Fire device - Sex nuts and bolts (SNB) supplied standard • SNB are required to use for wood doors, supplied standard
Mounting Height	Device center line from finished floor is 40" (1016mm) standard
Projection	Pushbar Neutral: 3-1/16" (78mm), Pushbar Depressed: 2-19/32" (66mm)

MODEL 8630S/8830S PANIC-RATED SVR EXIT DEVICE
MODEL 8630F/8830F FIRE-RATED SVR EXIT DEVICE



Certification

- **UL/cUL Listed:** Panic Exit Hardware or 3-hour Fire Exit Hardware
- **ANSI Certified:** Devices are ANSI A156.3 – 2001 Grade 1

Application

- Panic SVR exit devices are used for all types of single and double doors. Fire SVR exit devices are used for UL listed fire labeled pairs of doors up to 8' x 8' (2438mm x 2438mm)
- The exit devices are available in the following finishes: US32D and US10B.
- For LBR device

Above models are not available for 9' or 10' door height use. If doors are over 8' please specify when ordering.

Example:

- Model 10FT-8630S / 10FT-8830S
- Model 10FT-8630F / 10FT-8830F

Specifications

Device Lengths	<ul style="list-style-type: none"> • Standard (36"): 33-15/32" (850mm) • Long (48"): 44-3/4" (1137mm)
Door Widths	<ul style="list-style-type: none"> • 36" - For 29" to 36" (736mm to 914mm) doors • 48" - For 33" to 48" (838mm to 1219mm) doors
Minimum Stile Width	4-1/4" (107mm)
Latch Bolt	<ul style="list-style-type: none"> • Top latch - 5/8" (16mm) throw, can be deadlocked automatically • Bottom latch - 5/8" (16mm) throw, held retracted during door swing
Strikes	<ul style="list-style-type: none"> • Top: 812 (Panic), 822 (Fire). • Bottom: 815 (Panic), 825 (Fire)
Doggin Kit	<ul style="list-style-type: none"> • Panic device - Hex key dogging (RD) standard • Fire device - No mechanical dogging (ND)
Dogging Options	<ul style="list-style-type: none"> • Cylinder Dogging (CD) • Less Dogging (LD)
Mounting Fasteners	<ul style="list-style-type: none"> • Panic device - Machine screws furnished for device standard SNB furnished for top and bottom latches • Fire device - Sex nuts and bolts (SNB) supplied standard SNB are required for wood doors, supplied standard
Mounting Height	Device centerline from finished floor is 40" (1016mm) standard
Door Opening Height	Standard door height is 7' (Optional 8' door is available)
Vertical Rods	<ul style="list-style-type: none"> • 1/2" (13mm) diameter tubular with rod guides Top rod has two pieces to connect for accommodating 7' or 8' doors. • Bottom rod is one piece with a length of 31-1/4" (794mm)
Projection	Pushbar Neutral: 3-1/16" (78mm), Pushbar Depressed: 2-19/32" (66mm)

**MODEL LBR 8630S/LBR8830S PANIC-RATED SVR EXIT DEVICE LESS BOTTOM ROD
MODEL LBR 8630F/LBR8830F FIRE-RATED SVR EXIT DEVICE LESS BOTTOM ROD**



Certification

- **UL/cUL Listed:** Panic Exit Hardware or 3-hour Fire Exit Hardware
- **ANSI Certified:** Devices are ANSI A156.3 – 2001 Grade 1

Application

- Panic SVR exit devices are used for all types of single and double doors. Fire SVR exit devices are used for UL listed fire labeled pairs of doors up to 8' x 8' (2438mm x 2438mm)
- The exit devices are available in the following finishes: US32D and US10B.
- For LBR device

Above models are not available for 9' or 10' door height use. If doors are over 8' please specify when ordering.

Example:

- Model 10FT-8630S / 10FT-8830S
- Model 10FT-8630F / 10FT-8830F

Specifications

Device Lengths	<ul style="list-style-type: none"> • Standard (36"): 33-15/32" (850mm) • Long (48"): 44-3/4" (1137mm)
Door Widths	<ul style="list-style-type: none"> • 36" - For 29" to 36" (736mm to 914mm) doors • 48" - For 33" to 48" (838mm to 1219mm) doors
Minimum Stile Width	4-1/4" (107mm)
Latch Bolt	<ul style="list-style-type: none"> • Top latch - 5/8" (16mm) throw, can be deadlocked automatically • Bottom latch - 5/8" (16mm) throw, held retracted during door swing
Strikes	<ul style="list-style-type: none"> • Top: 812 (Panic), 822 (Fire). • Bottom: 815 (Panic), 825 (Fire)
Doggin Kit	<ul style="list-style-type: none"> • Panic device - Hex key dogging (RD) standard • Fire device - No mechanical dogging (ND)
Dogging Options	<ul style="list-style-type: none"> • Cylinder Dogging (CD) • Less Dogging (LD)
Mounting Fasteners	<ul style="list-style-type: none"> • Panic device - Machine screws furnished for device standard <i>SNB furnished for top and bottom latches</i> • Fire device - Sex nuts and bolts (SNB) supplied standard <i>SNB are required for wood doors, supplied standard</i>
Mounting Height	Device centerline from finished floor is 40" (1016mm) standard
Door Opening Height	Standard door height is 7' (Optional 8' door is available)
Vertical Rods	<ul style="list-style-type: none"> • 1/2" (13mm) diameter tubular with rod guides Top rod has two pieces to connect for accommodating 7' or 8' doors. • Bottom rod is one piece with a length of 31-1/4" (794mm)
Projection	Pushbar Neutral: 3-1/16" (78mm), Pushbar Depressed: 2-19/32" (66mm)

CONCEALED VERTICAL ROD

MODEL 8650S/8850S PANIC-RATED CVR EXIT DEVICE

MODEL 8650F/8850F FIRE-RATED CVR EXIT DEVICE



Certification

- **UL/cUL Listed:** Panic Exit Hardware or 3-hour Fire Exit Hardware
- **ANSI Certified:** Devices are ANSI A156.3 – 2001 Grade 1

Application

- Panic CVR exit devices are used on single or double metal doors. Fire CVR exit devices are used for UL listed fire labeled pairs of steel doors up to 8' x 8' (2438mm x 2438mm).
- The exit devices are available in the following finishes: US32D and US10B.
- CVR models can not be installed without bottom rod (LBR), only Surface (SVR) models can only be installed less bottom rod.

Above models are not available for 9' or 10' door height use. If doors are over 8' please specify when ordering.

Example:

- Model 10FT-8650S / 10FT-8850S
- Model 10FT-8650F / 10FT-8850F

Specifications

Device Lengths	<ul style="list-style-type: none"> • Standard (36"): 33-15/32" (850mm) • Long (48"): 44-3/4" (1137mm)
Door Widths	<ul style="list-style-type: none"> • 36" - For 29" to 36" (736mm to 914mm) doors • 48" - For 33" to 48" (838mm to 1219mm) doors
Minimum Stile Width	4-1/4" (107mm)
Latch Bolt	<ul style="list-style-type: none"> • Top latch - 5/8" (16mm) throw, can be deadlocked automatically • Bottom latch - 5/8" (16mm) throw, held retracted during door swing
Strikes	<ul style="list-style-type: none"> • Top: 812 (Panic), 823 (Fire). • Bottom: 815 (Panic), 825 (Fire)
Doggin Kit	<ul style="list-style-type: none"> • Panic device - Hex key dogging (RD) standard • Fire device - No mechanical dogging (ND)
Dogging Options	<ul style="list-style-type: none"> • Cylinder Dogging (CD) • Less Dogging (LD)
Mounting Fasteners	<ul style="list-style-type: none"> • Panic device - Machine screws furnished for device standard <i>SNB furnished for top and bottom latches</i> • Fire device - Sex nuts and bolts (SNB) supplied standard <i>SNB are required for wood doors, supplied standard</i>
Mounting Height	Device centerline from finished floor is 40" (1016mm) standard
Door Opening Height	Standard door height is 7' (Optional 8' door is available)
Vertical Rods	<ul style="list-style-type: none"> • 1/2" (13mm) diameter tubular with rod guides Top rod has two pieces to connect for accommodating 7' or 8' doors. • Bottom rod is one piece with a length of 31-1/4" (794mm)
Projection	Pushbar Neutral: 3-1/16" (78mm), Pushbar Depressed: 2-19/32" (66mm)

FINISHES		
Zinc Plated	603	US2G
Bright Brass	605	US3
Satin Brass	606	US4
Bright Bronze	611	US9
Satin Bronze	612	US10
Dark Bronze	613	US10B
Bright Chrome	625	US26
Satin Chrome	626	US26D
Satin Aluminum	628	US28
Bright Stainless Steel	629	US32
Satin Stainless Steel	630	US32D
Painted Primed	600	USP
Painted Aluminum	689	S1
Painted Brass (to match US4)	696	S2
Painted Bronze (to match US10)	691	S3
Painted Black	693	S4
Painted Dark Bronze (to match US10B)	690	S5
Painted White	–	S8
• NOTE: Not all finishes are stocked. Some will require additional lead time.		

West Warehouse Territory

East Warehouse Territory

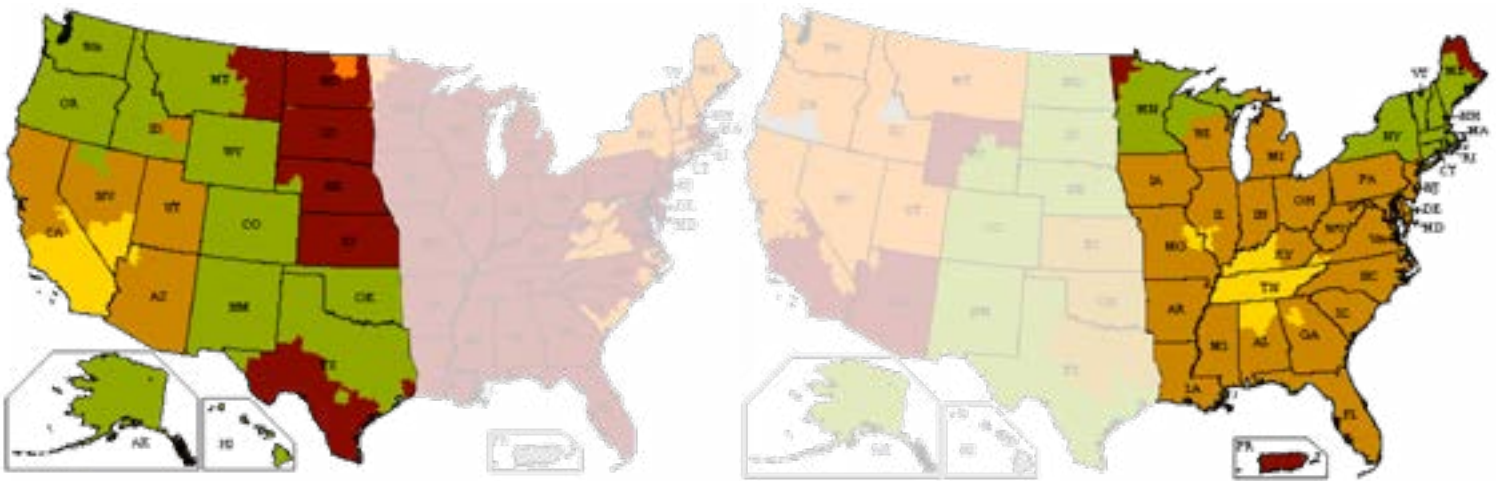

UPS Outbound View

Transit Days From Anaheim, CA and Nashville, TN Warehouse:

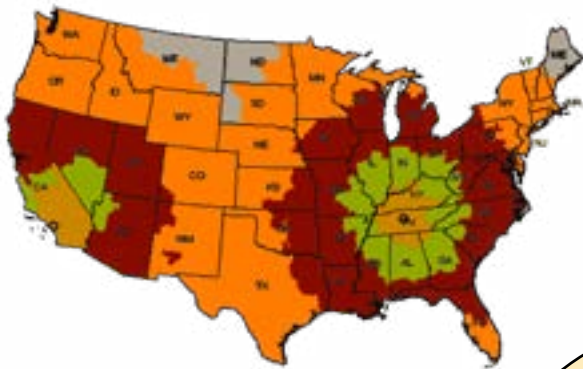

FedEx Flat Rate Outbound View

International Door Closers RAPID Ship program will utilize the most **RAPID AND COST-EFFECTIVE SHIPPING** method to fit your needs. Contact us **TODAY!**



West Coast Office

International Door Closers, Inc.
4431 E. La Palma, Anaheim, CA 92807
Tel: (714) 666-0390 • (800) 544-4422
Fax: (714) 666-2215

East Coast Office

International Door Closers, Inc.
1920 Air Lane Drive, Nashville, TN 37210
Tel: (615) 885-7060 • (800) 225-6737
Fax: (615) 885-0903

www.intldoorclosers.com