



# 2830 Knob/2835 Lever Mechanical Keyless Lock Installation Instructions



**IMPORTANT INFORMATION ABOUT YOUR LOCK**

- When the door is closed, the system locks automatically.
- From the inside, unlock using the knob/lever handle.
- From the outside, unlock by pressing 'C' (CLEAR), followed by your User Code.
- Your lock is equipped with a PASSAGE FUNCTION, allowing you to leave the door unlocked.**  
**\*\*USING THE PASSAGE FUNCTION WILL COMPROMISE THE SECURITY OF THIS LOCK\*\***  
**-To enable the passage function:**  
 Press 'C' (CLEAR), then 'Y' (PASSAGE), then enter User Code.  
**-To disable the passage function:**  
 Press 'Y' (PASSAGE), followed by 'C' (CLEAR).  
**-To disable the passage function PERMANENTLY:**  
 Remove the 'Y' (PASSAGE) tumbler, leaving that slot empty.

**IMPORTANT:** Always press and hold the 'C' Button when removing and inserting Tumblers. Refer to 'How to Change Code' instructions on reverse side.

No.	Part Name	Included
1	Outside Body	1
2	Inside Body	1
3	Handle (2835 Lever/2830 Knob)	2
4	Rubber Trim Plate	2
5	Strike Plate	1
6	Mortised Striker	1
7	Spindle	1
8	Allen Wrench	1
9	Machine Screw M4 x 40mm	2
10	Machine Screw M4 x 30mm   50mm	1   1
11	Wood Screw M4 x 16mm	4
12	Extra Code Tumblers (Red)	1
13	Extra Non-Code Tumblers (Blue)	2
14	Adjustable Latch 2 3/8" - 2 3/4"	1
15	Support Pin	1
16	Tweezers	1
17	Hex Bolts	2

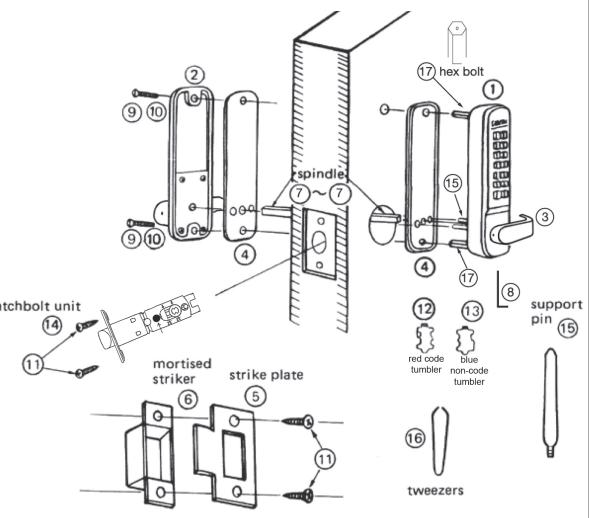

**Step 1: Change User Code/Combination (OPTIONAL)**  
 To change user code/combination, see instructions on reverse side.

**Step 2: Prep Door for Installation with Template**  
 Place template (supplied) on door and fold along door's edge.  
 Mark holes for 2 3/8" or 2 3/4" backset. Drill holes as instructed.  
*Note: For pre-prepped 2 1/8" doors, you only need to drill top hole.*

**Step 3: Identify Door Handing**

Right-Hand Doors – From exterior of door, hinges are on right-side (Fig. 1).  
 Left-Hand Doors – From exterior of door, hinges are on left-side (Fig. 2).

For Right-Hand Doors: Install Support Pin (#15) in position 'A'.  
 For Left-Hand Doors: Install the Support Pin (#15) in position 'B'.

Now, install/screw Hex Bolts (#17) into the top and bottom as shown.

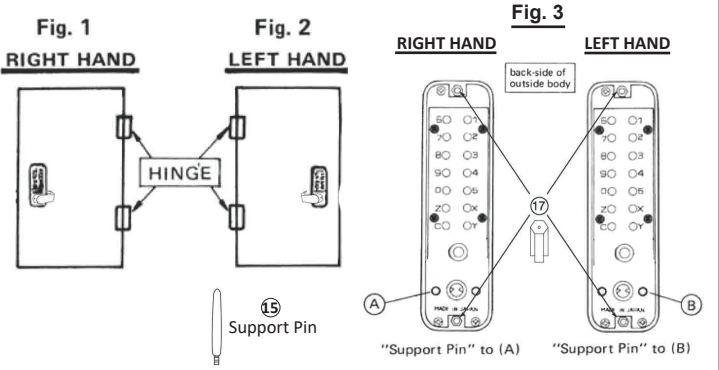

**Step 4: Install Handles (2835 Levers or 2830 Knobs)**  
 Using Allen Wrench (#8), install handles to the inside and outside bodies.  
 Secure with set screws.

*Note: For 2835, levers should point towards the door hinges.*

*Note: The 2835 is equipped with a built-in slip clutch lever handle to prevent damage in the event of an attempted forced entry. If lever handle is in position shown (far right), pull lever back to desired position.*

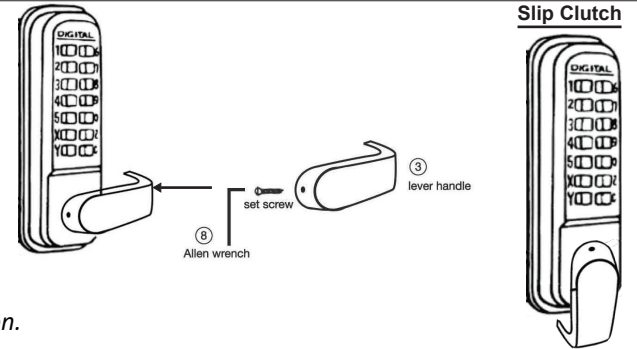

**Step 5: Adjust Latch (if necessary) and Install**  
 Adjustable Latch (#14) is preset to 2 3/8" backset.  
 To adjust: Remove plastic plug, slide to 2 3/4", and replace plastic plug as shown (Fig. 5).  
 Insert Adjustable Latch (#14) into the door.  
 Secure with two (2) Wood Screws (#11).

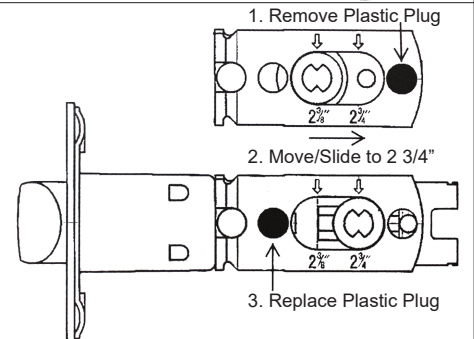

## INSTALLATION INSTRUCTIONS CONTINUED:

### Step 6: Verify Correct Spindle Length (Fig. 6)

With Adjustable Latch (#14) installed, hold the Inside Body (#2) and Rubber Trim Plate (#3) to the door. Place Spindle (#7) through Latch, into the Inside Body, as far as possible. Spindle should extend from exterior of door 3/8" min. to 5/8" max. If Spindle (#7) is too long, cut it to the correct length using Pliers.

**\*IMPORTANT:**

If spindle extends less than 3/8" it may not engage the lock.  
If spindle extends more than 5/8", it will cause the lock to bind.

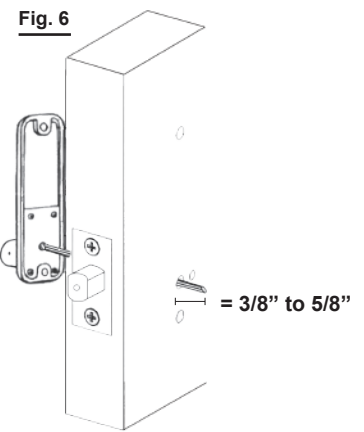

### Step 7: Install the lock

Place the Rubber Trim Plate (#4) on the backside of the Outside Body (#1). Place the Outside Body on the door. The hex bolts (#17) should extend into the top and bottom holes. The Support Pin (#15) should extend through the hole in the Latch (#14). Insert the Spindle (#7) into the Outside Body (#1) ensuring it's in the proper angled position.

**\*IMPORTANT: SPINDLE POSITION/ANGLE**

**RIGHT-HAND DOORS:** From inside, place spindle through Latch, into the Outside Body in the 2:00/8:00 position (Fig. 7).  
**LEFT-HAND DOORS:** From inside, place spindle through Latch, into the Outside Body in the 10:00/4:00 position (Fig. 8).

**Fig. 7**  
Right-Hand Door  
(INSIDE DOOR)

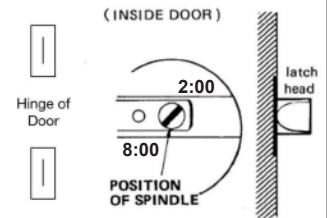

**Fig. 8**  
Left-Hand Door  
(INSIDE DOOR)

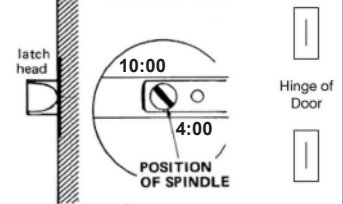

Place the Rubber Trim Plate (#4) and Inside Body (#2) on the inside of the door. Using a screwdriver, secure the lock to the door with Screws (#9 or #10). (Screw length is dependent on door thickness.)

Test the operation of the latch by turning the inside lever.

Locate position where latch strikes door frame and install Strike Plate (#5) and Mortised Striker (#4).

**TEST YOUR LOCK:** Press 'C' button (clear), followed by your combination. Push lever down and lock will open.

**TEST PASSAGE:** Press 'C', followed by 'Y', followed by combination. Lock will remain unlocked (passage).

**TO LOCK:** Push 'Y', followed by 'C'. Lock will remain locked.

**NOTE:** If lever/knob must be turned up to unlock, change spindle position/angle (see figures 7 and 8).

**If latch sticks:** First, make sure Support Pin (#15) is in place. Second, verify correct spindle length (see step 6).

## SAVE — — — — — How to Change User Code/Combination

- Using a #2 screwdriver, remove the four (4) Red Screws.
- Carefully remove cover plate.

**WARNING: Springs are attached to plate.**

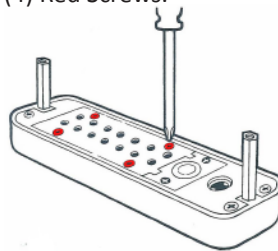

- 'C' = CLEAR (DO NOT REMOVE)  
'Y' = PASSAGE ('Y' Tumbler may be removed to disable PASSAGE FUNCTION)
- PRESS & HOLD 'C' BUTTON to release tumblers.

**IMPORTANT:** 'C' button **MUST** be pressed and held down when removing and inserting tumblers. Failure to do so will damage the lock and void the warranty.



**WARNING:**  
Do NOT force tumblers into position!

- While holding the 'C' BUTTON, remove/add **CODE (Red)** and **NONCODE (Blue)** tumblers to create your desired code.  
Ex: 3 Red = 3-Digit Code / 6 Red = 6-Digit Code
- After changing your code, release the 'C' BUTTON to secure the tumblers in place.

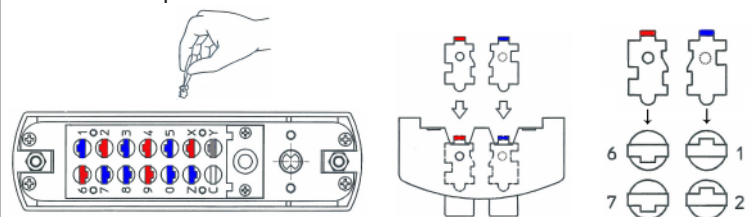

- Replace the cover plate and secure with four (4) Red Screws, using a #2 screwdriver.
- TEST CODE before installing/re-installing lock.

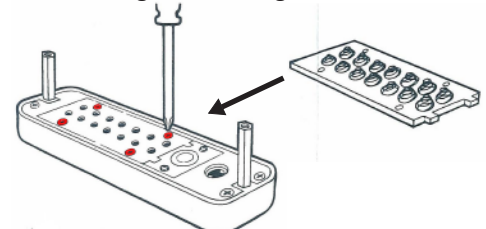

For more helpful tips and installation instructions, visit [www.LOCKEYUSA.com](http://www.LOCKEYUSA.com)

# DIGITAL DOOR LOCK

## TEMPLATE

For Models:  
2230 , 2435, 2835

### FOR BACK SET 60M/M(2-3/8")

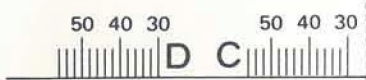
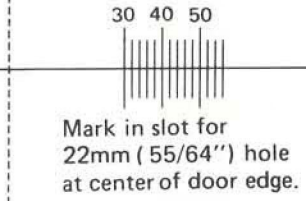
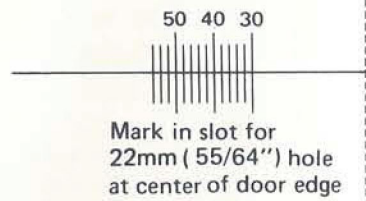
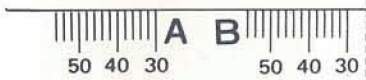
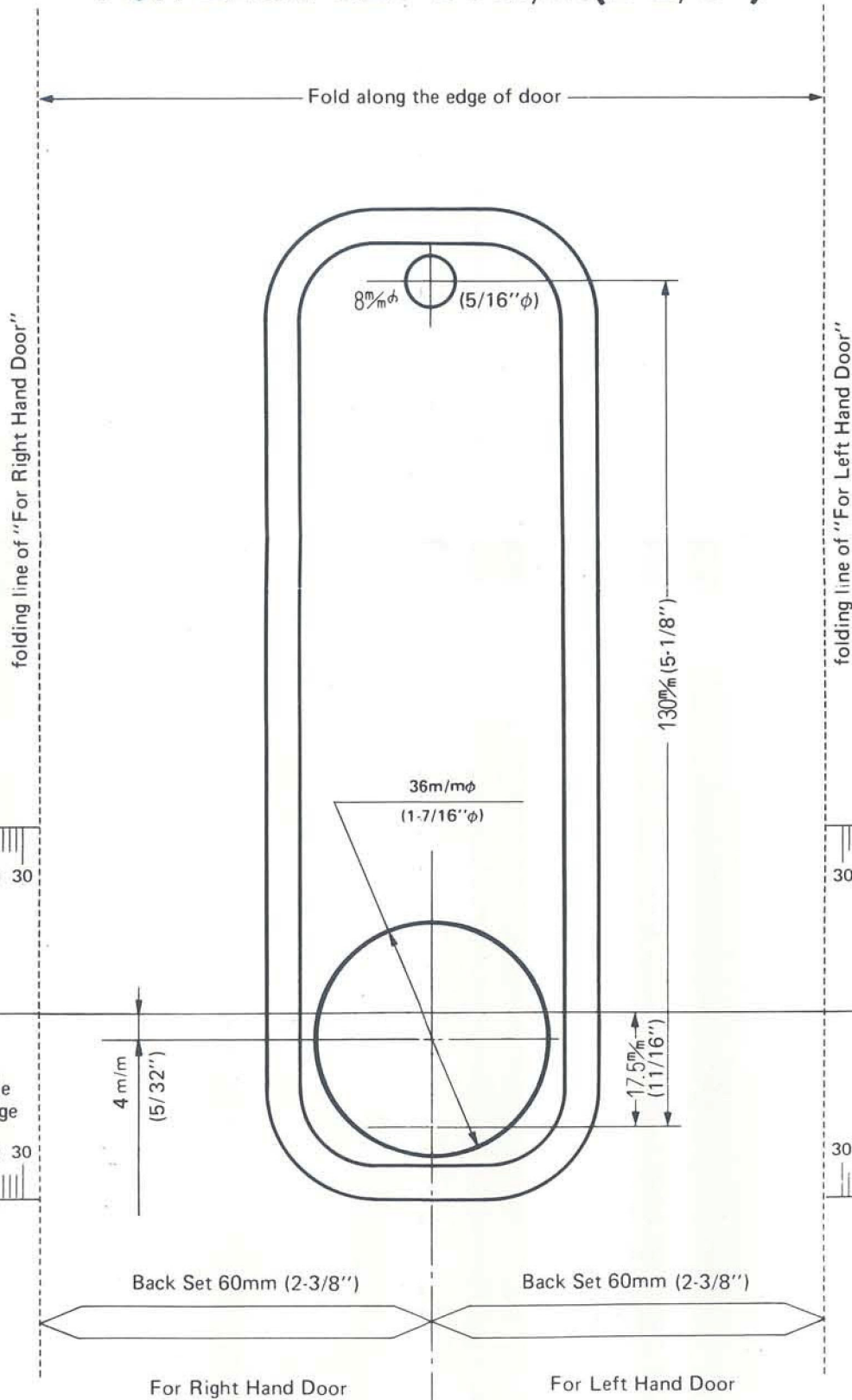

# DIGITAL DOOR LOCK

## TEMPLATE

For Models:  
2230, 2435, 2835

### FOR BACK SET 70M/M(2-3/4")

