

Limited Warranty Statements

1. Warranty

LockeyUSA "LDS" warrants the Product to be free from defects in material and workmanship for a period of 12-months from the original date of purchase.

If you discover a defect in the Product covered by the warranty, we will repair or replace the item using new or refurbished components.

2. Exclusions

The warranty covers defects in manufacturing and/or workmanship discovered while using Product as recommended by LDS rather than those caused by acts of God, misuse, abuse, installation errors or unauthorized modifications.

3. Limited Liability

LDS will not be held liable for incidental or consequential losses or damages caused by any act of God, misuse, abuse or unauthorized modification of Product.

4. Reminder

Service requirement shall be subject to the presentation of this warranty card and defective parts to the manufacturer, LDS. The warranty card will not be reissued if lost.

Product: E-DIGITAL ELECTRONIC DEADBOLT LOCK

Purchase Date: _____

Name & Address of Distributor: _____

Send warranty forms to:
 LockeyUSA Warranty Department
 PO Box 543 | Mt. Pleasant, Michigan | 48858
 www.lockeyusa.com



E-DIGITAL ELECTRONIC LOCK SERIES

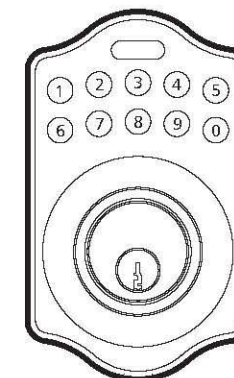

USER MANUAL



Attention : Do not use power tools

E-DIGITAL ELECTRONIC DEADBOLT INSTALLATION INSTRUCTIONS

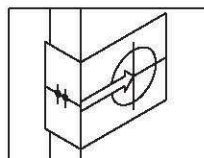

The BACKSET is the distance between the center of cross bore and edge bore of the door. Adjustable latch fits both BACKSET of 2-3/8" (60mm) and 2-3/4" (70mm). Please follow the steps shown below for BACKSET adjustment.

Latch Backset Adjustment :

Rotate the latch case as diagram on the right for backset 2-3/4" (70mm) or reverse direction for 2-3/8" (60mm).

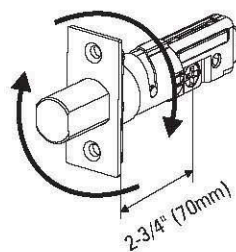

Please Note: If you have a pre-drilled bore or are replacing an existing lock, remove all existing hardware and strike, and skip to Step 3.

1. Mark The Door With Template

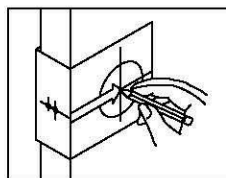

Select the height and backset as desired on the door face ; use the TEMPLATE as an indication to mark the center of the circle on the door face and the center of the door edge.

2. Drill Holes

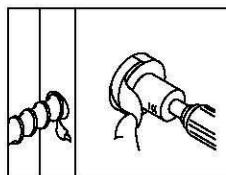

Using the marks as a guide to drill a hole \varnothing 2-1/8" (54mm) through the door face for the lockset, then a hole of \varnothing 1" (25.4mm) for latch.

1

3. Install Latch

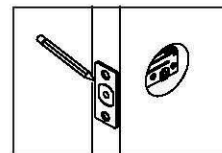

a. Insert the latch and ensure it is paralleled to the door face. Mark the outline of the faceplate, then take out the latch.

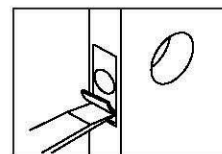

b. Chisel 1/8" (3mm) deep along the outline to allow the faceplate to be aligned with the door edge.

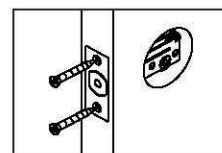

c. Insert the latch and tighten it with screws. Note : please use tapping screws for metal door.

4. Install Strike

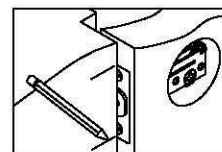

a. To identify the center of strike : close the door, on the basis of the faceplate mark horizontal center line of strike. Ensure the center of faceplate and the center of strike are aligned. Use the mark as a guide outlines the strike.

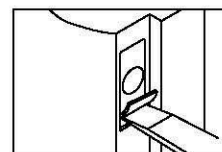

b. Chisel 5/64" (2mm) deep along the strike outline to allow the strike to be aligned with the doorframe.

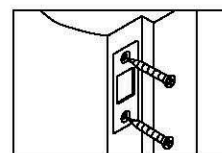

c. Insert the strike and tighten it with screws. Note : please use "tapping screws" for metal door.

2

5. Install Keypad Assembly

- Latch bolt must be retracted in unlocked position.
- Please refer to the diagram below for Cylinder Installation. Place deadbolt against keypad with tailpiece in horizontal position inserted through hub of the latch.
- Pass the IC wire under the latch to the interior side of the door.

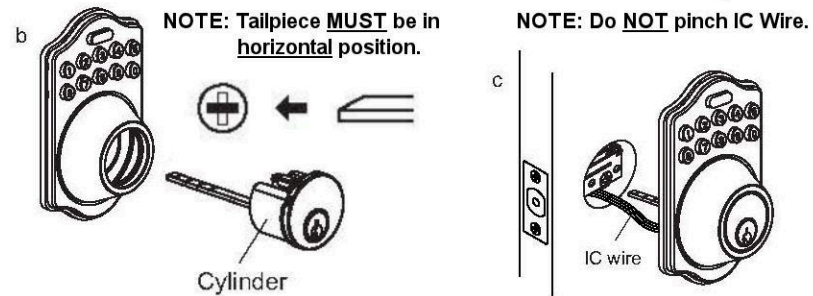

6. Install Inside Mounting Plate

Pass the IC wire through the wire hole of the mounting plate. Fix the mounting plate with screws. If outside lock assembly is lopsided, please loosen the screws to adjust it's position and tighten the screws again.

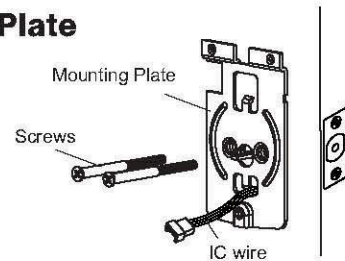

NOTE: Do NOT pinch IC Wire.

7. Identify Door Handing

Face the door from outside, the door is left handed if the hinge is on the left-hand side of the door, whereas the door is right handed if the hinge is on the right-hand side of the door.

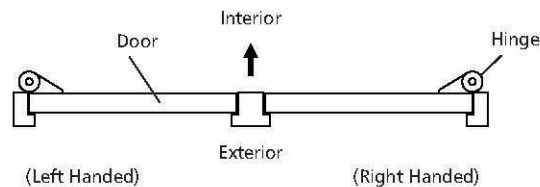

3

8. Adjusting Turn Piece

Ensure the turnpiece is in the unlocked position. To unlock, turn the turnpiece to the right for a Left-Handed door. Turn the turnpiece to the left for a Right-Handed door.

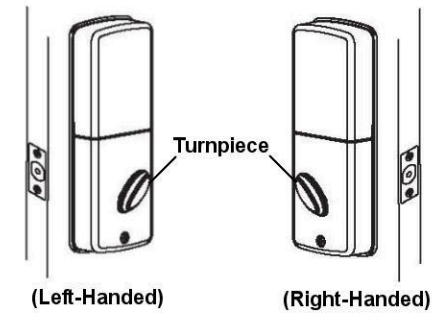

The door **MUST** remain in the unlocked position for the duration of installation and programming.

9. Install receiver module

- Remove the battery cover (push it up and pull it out).
- Connect the IC wire and ensure the tailpiece is engaged with turn piece, then attach receiver module to the door with screws. It's optional to use wood screws. (Wood screws only for wood door)
- Insert 4 (AA) 1.5V alkaline batteries and put the battery cover back on the receiver module.

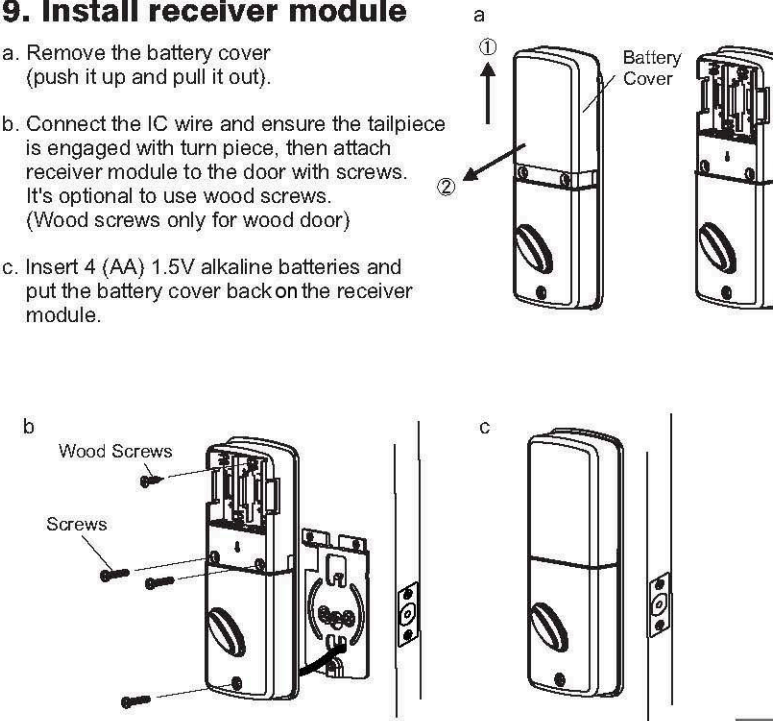

4

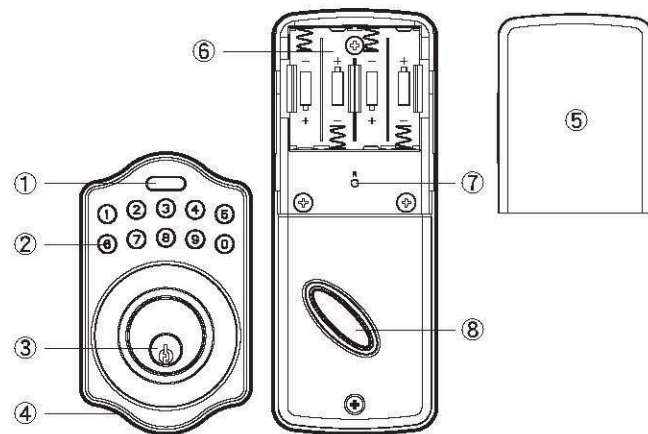

① Programming Button

Programming Button is for entering codes, clearing errors and setting function. It's also lock button.

② Number Buttons

Input the pass codes, each pass code is 4-10 digits in length.

③ Cylinder

Retract / Extend the latch bolt by key from exterior.

④ Washer

Prevent water permeating into lockset.

⑤ Battery Lid

Slide the lid to change the batteries or restore default setting.

⑥ Battery Holder

Four AA (1.5V) Alkaline batteries.

⑦ R Button (Reset)

Restore default setting.

⑧ Turn-Piece

Retract/Extend the latch bolt from interior.

Specification/Function

1. Power

6V - Requires four AA (1.5V) Alkaline batteries.

2. Low Battery

2-1 The batteries should be changed immediately when you see button 1 flashing in red and hear 10 rapid beep sounds when pressing programming button.

2-2 All settings are retained in the memory and will not be effected even if the battery is completely dead.

2-3 The lock can still be operated by key if the lock is without power.

3. Illuminated Indicator

3-1 Button 1 flashes green once for successful operation.

3-2 Button 1 flashes in green twice for successful programming.

3-3 Button 1 flashes in red 3-times when there is an operation error.

3-4 Button 1 flashes in red 5-times for code input errors. the system will shut down for system protection after 5 incorrect entries (Refer to #17).

3-5 Button 1 flashes in orange 3-times when system has been restored to default setting.

3-6 Button 1 flashes in orange slowly while in programming mode.

4. Audible Indicator

4-1 1 beep sound indicates a successful operation.

4-2 2 long beep sounds indicate successful programming.

4-3 3 beep sounds indicate an operation error.

4-4 3 long beep sounds indicate that the system has been restored to default settings.

4-5 5 beep sounds indicate code input error. System will shut down after 5 incorrect entries. (Refer to #16)

4-6 10 rapid beep sounds indicate that the batteries are low. Change batteries immediately.

5. Programming Code

5-1 The preset Programming Code is 0000. Please change Programming Code after first operation.

5-2 Programming Code is only for function setting. You cannot unlock the lockset by entering Programming Code.

5-3 Programming Code must be 4-10 digits.

5-4 If necessary, Programming Code can be changed at any time.

6. User Codes

- 6-1 The preset User Code is 1234. Please delete it and create a new User Code during first operation.
- 6-2 Up to 6 sets of User Codes can be saved at one time.
- 6-3 User Codes are only used to unlock the lockset.
- 6-4 User Codes must be 4-10 digits.
- 6-5 User Codes can be added or deleted at any time.

7. Deleting Individual User Codes

- 7-1 User Codes can be deleted individually. You can reset the same number code even if it has been deleted previously.
- 7-2 Programming Code is needed when deleting individual User Codes.

8. Deleting All User Codes At Once

- 8-1 All User Codes can be deleted at once. You can still reset and use the same User Codes even if you have deleted them previously.
- 8-2 Auto-locking and Keypad locking functions will be invalid after deleting all User Codes and the lock will only be operational with the key. These functions will be restored with the creation of new User Codes.
- 8-3 Programming Code is needed when deleting all User Codes.

9. Temporarily Disabling All User Codes

- 9-1 Auto-locking and Keypad locking function will be invalid when User Codes are temporarily disabled. The lock can only be operated by key during this time.
- 9-2 Repeat the programming steps to restore the auto-locking and keypad locking functions once User Codes are restored.

10. Creating Disposable User Codes

- 10-1 Disposable User Codes are invalid after one use.
- 10-2 You can reset the same numbers as User Codes.
- 10-3 Programming Code is needed when creating Disposable User Codes.

11. Restoring Preset Factory Codes

- 11-1 You can restore the Preset Factory Code by pressing the "R" button on the interior of the receiver module. Used when you forget your Programming Code or you want to cancel all previously created settings.
- 11-2 After system restore, the Programming Code will be "0000" and the User Code will be "1234".

12. Unlocking the Lockset

The lockset can be unlocked by key, by entering the User Code and E-Digital button on the keypad or with the turnpiece on the interior of the door.

13. Locking the Lockset

The lockset can be locked by key, by pressing the Programming Button "E-Digital" on the keypad or with the turnpiece on the interior of the door.

14. Incomplete Door Closing/Opening

- 14-1 When the latch bolt is not extended/retracted completely, the motor will not function correctly when you will see the LED light flash 3-times accompanied by 3 beep sounds. The alarm will not sound when the device is in Mute. You will need to enter the User Code to unlock the door and press the Programming Button to re-lock the door.
- 14-2 If the latch bolt gets stuck or cannot extend/retract completely repeatedly, please check to ensure the strike aligns correctly with the latch bolt and adjust the strike as needed.
Note: After long use of any door hinge, the latch bolt may get stuck easily as a result of the door being lopsided or deformed.

15. Activating/Deactivating the Auto-Locking Function

- 15-1 The lockset will automatically lock itself within 10-99 seconds when this function is programmed.
- 15-2 The function is not preset and must be programmed to operate.
- 15-3 The preset delay-time is 30-seconds. The delay-time can be adjusted as needed.
- 15-4 The same programming steps are used to both activate and deactivate the auto-locking function.

16. Turn Mute On/Off

- 16-1 Beep sounds will be heard when pressing keypad, and for programming and operating errors.
- 16-2 LED Illumination will still function while in Mute. The warning alarm will not function while muted, and it is recommended not to Mute device unless necessary.
- 16-3 The normal operating sounds of the motor cannot be muted.

17. Code Protection Function

The system will shut down when incorrect codes are entered more than 5-times.
The system will be restored after 45-seconds of inactivity.

18. Illumination

The LED Keypad will light up when pressing any button to ensure ease of operation in the dark.

User Code & Function Setup

1. The lock **must** be in the unlocked position while programming.
2. You **must** run the door-handing identification process before continuing with programming of the lock. See Function Programming instructions on the following page.
3. Change default Programming Code "0000" and User Code "1234" before function setup.
4. LED flashes orange slowly while programming. LED flashes green twice with two long beeps when input is correct. LED flashes red three times with three beeps when incorrect. You will need to wait 6-seconds or press programming button when incorrect input is entered. After 6-seconds system operations will be restored.
5. Each programming step should be completed within 6-seconds.
6. You can lock/unlock the product with both the key and the keypad. Please refer to the programming table on the following page for function setup instructions.

IMPORTANT

1. The use of alkaline batteries is recommended to stabilize the power supply.
2. Do **not** mix battery brands or mix alkaline batteries with regular zinc-oxide batteries.
3. Do **not** use any chemical liquid or lubricating oil with additives to clean the lock body. Use of these products could damage the product's surface and/or mainboard.
4. If there is any problem with the product, please contact LockeyUSA "LDS".

Function Programming

Programming Code (PC)

USER Code (UC)

PLEASE NOTE: LOCK MUST BE IN UNLOCKED POSITION TO PROGRAM

Detect Left/Right Hand Door Configuration

Enter PC → E-Digital → 0 → E-Digital

Remark:

You **must** run the door-handing identification process before function set up for installation or after default setting restore. The lock **must** remain unlocked while programming.

Add New User Codes

Enter PC → E-Digital → 1 → E-Digital → Enter New UC → E-Digital

Remark:

Up to 6 sets of User Codes can be saved. User Codes can be 4-10 digits in length.

Delete Existing User Codes

Enter PC → E-Digital → 2 → E-Digital → Enter the UC you want to delete → E-Digital

Delete All User Codes

Enter PC → E-Digital → 3 → E-Digital

Remark:

Auto-locking and Keypad locking function will be invalid when User Codes are deleted. The lock can only be operated by key during this time.

Change Programming Code

Enter PC → E-Digital → 4 → E-Digital → Enter New PC → E-Digital

Turn Autolock On/Off

Enter PC → E-Digital → 5 → E-Digital

Remark:

The preset delay-time is 30-seconds. You can change the time by following the instructions on the following page. Repeat the steps to disable the Auto-locking function.

PLEASE NOTE: LOCK MUST BE IN UNLOCKED POSITION TO SUCCESSFULLY COMPLETE PROGRAMMING FUNCTIONS. Programming Code (PC) USER Code (UC)

Set Autolock Time Delay



Remark: Delay time can be 10-99 seconds in duration.

Turn Mute On/Off



Remark: Repeat same steps to turn Mute On/Off.
LED illuminations will still function when Mute is On, but there will be no warning alarm.

Enable/Disable All User Codes



Remark: Auto-locking and Keypad functions will be invalid when User Codes are disabled. The lock can only be operated by key during this time. Repeat the steps shown above to enable User Codes.

Create Disposable User Codes



Remark: Disposable Codes will be invalid after a single use.

Restore All Preset Factory Settings

Press **(R)** on the interior of the receiver module.

Remark: Press and hold button for more than 5-seconds. The programming will be complete after you hear 3 long beeps.
After system restore, you must run the door-handing identification process again, prior to any other function programming.

Simple Troubleshooting

Situation 1

After installation of the lockset and batteries the door cannot be locked and three short beeps are emitted when pressing the Programming Button.

Causes: The door-handing identification process is not complete yet.

Solutions: Execute the door-handing identification process. The door-handing identification process **must** be completed prior to any other programming function.

Situation 2

After installation of the lockset and batteries there is no response when pressing any button (no sounds are emitted and the back light does not work).

Causes: This problem could be caused by malfunctioning batteries or the IC Wire being improperly connected.

Solutions: Check to confirm that the batteries are inserted correctly or if the batteries may be dead (replace if necessary). If the lock is still not working correctly, check the IC Wire to ensure it is connected properly.

Situation 3

Failure in the first execution of the door-handing identification process (the red light flashes three times and three short beeps are emitted).

Causes: Wrong door-handing or change of the door-handing in the lock's memory.

Solutions: Press the "R" button on the interior of the receiver module to restore the system's Preset Factory Settings and re-execute the door-handing identification process.

Situation 4

After successful execution of the door-handing identification process, the latch does not work (The motor seems to be running with low power, the latch bolt is stuck and the turnpiece on the interior of the door cannot be rotated).

Causes: Low Battery

Solutions: Replace with new batteries.

Situation 5

The lock is functioning normally, but suddenly, the latch bolt locks up and the turnpiece on the interior of the door cannot be rotated (not even with the key).

Causes: The detection of the latch bolt position is abnormal.

Solutions: First, take out one battery. Then, press any button on the front panel for electric discharge and replace the battery. The latch bolt will automatically re-detect the correct position.

Attention: If the latch gets stuck frequently, check to see if the opening of the strike aims at the central position of the latch bolt, if the latch bolt can extend out freely or if the hinges are deformed or tilted.

Situation 6

The door locks normally, but three short beeps are emitted and the door will not unlock when the User Code is entered and the Programming Button is pressed.

Causes: The functioning of the micro-switch is abnormal.

Solutions: Use the key to unlock the door. Then contact LDS for more detailed troubleshooting instructions.

Situation 7

While the door is closed, the latch bolt can be heard coming out when pressing the Programming Button to lock the door and three short beeps are emitted.

Conversely, while the door is open, no beeps are emitted when pressing the Programming Button to lock the door.

Causes: (1) The depth of the latch bolt hole is insufficient.

(2) The latch bolt is not aimed at the opening of the strike.

Solutions: (1) Drill the latch bolt hole for the strike deeper (min. 2.5 cm)

(2) Adjust the strike to ensure the latch bolt is aimed properly.

Visit www.LockeyUSA.com for additional product information.