

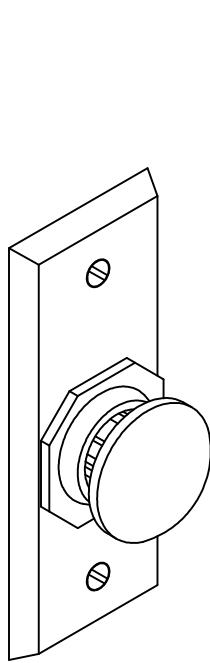

INSTALLATION INSTRUCTIONS

MODELS 431 – 446 MUSHROOM PUSH SWITCH



431N / 432N

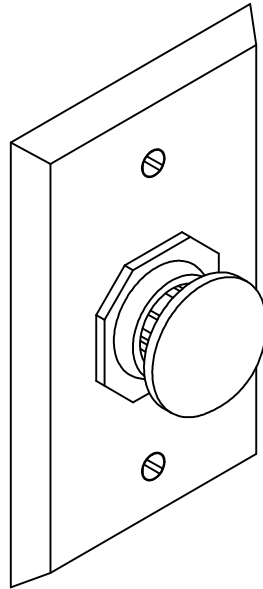

431 / 432

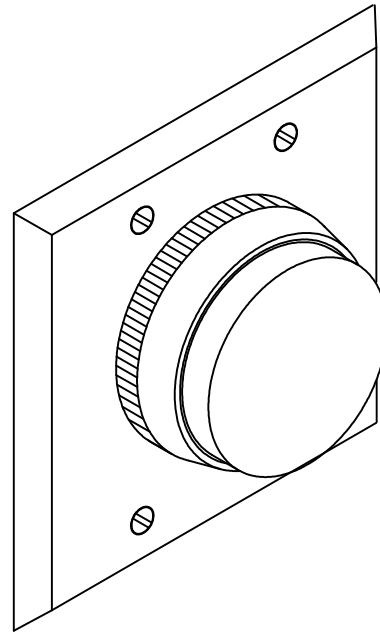

441 - 444

* Model 446 not shown.

Electrical Specifications

Contact Type: SPST or DPST (Form C)
Contact Ratings: 30VDC @ 5AMPS (Resistive)

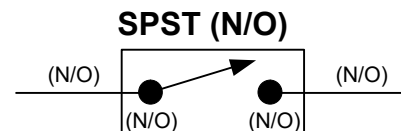
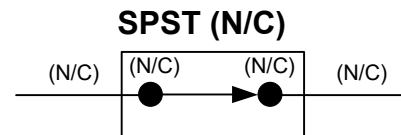
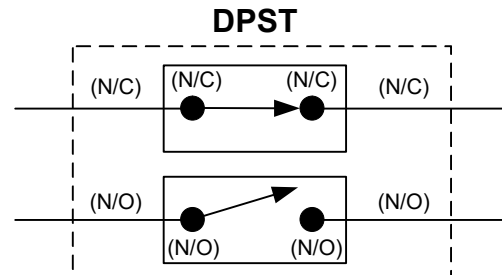
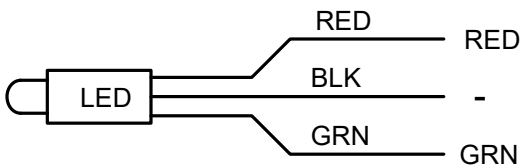

Any suggestions or comments to this instruction or product are welcome. Please contact us through our website or email engineer@sdsecurity.com