

Architectural Door Accessories

McKinney 5 x 4 1/2 Full Mortise Anchor Template Hinges For Square Edge Doors

The global leader in
door opening solutions

DO NOT SCALE
DIMENSIONS: INCHES (MM)

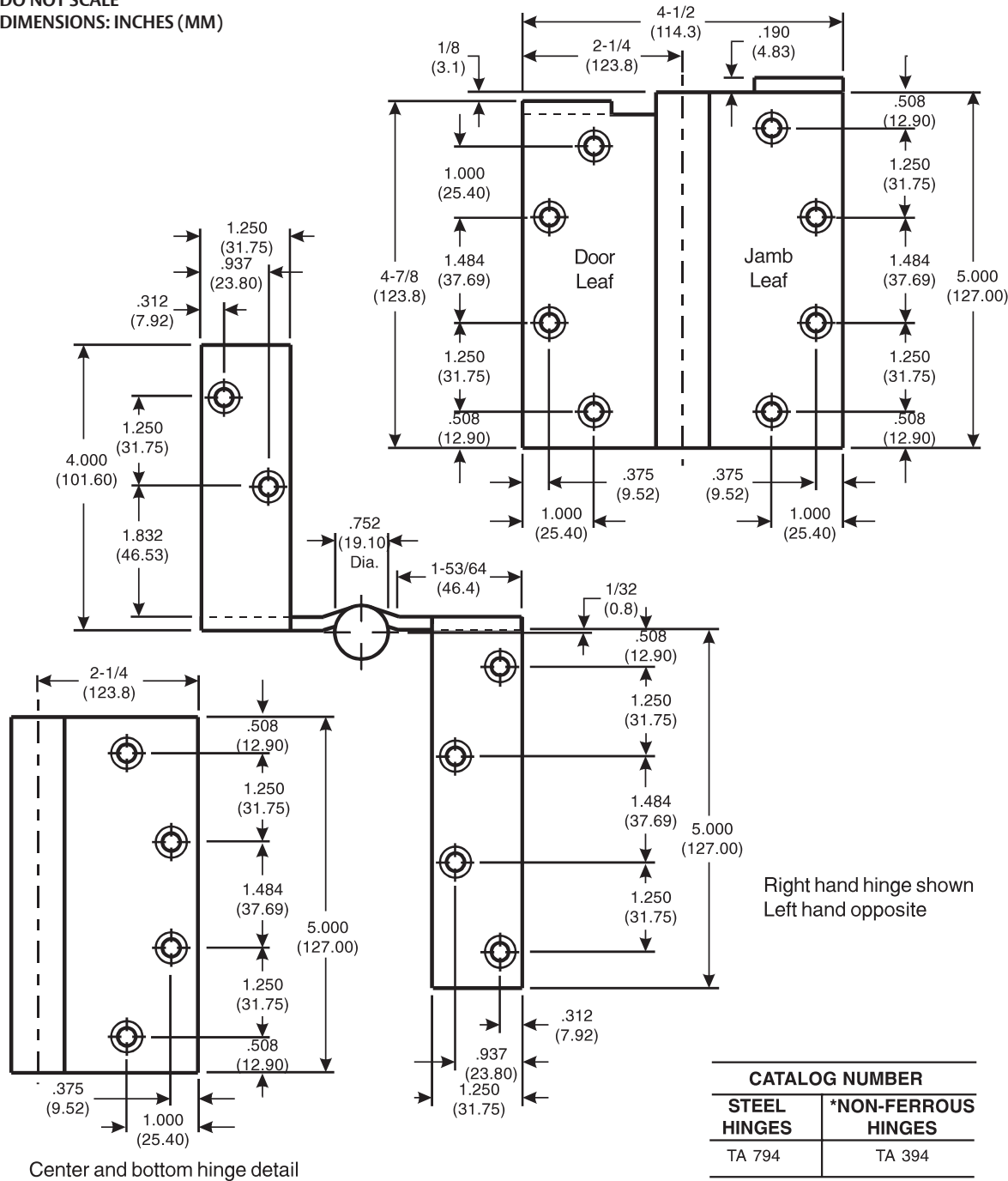

Template 096-98

Effective date:
March 30, 1998

Supersedes: All Previous

McKINNEY Template
Anchor Hinges are made in
size, gauge and with screw
holes located to conform
to this drawing.

Machine Screw Size:
1/2 x 12-24 F.H.

Wood Screw Size:
1 1/4 x 12 F.H.

Hinges are handed.

*Check Catalog for Metals.

225 Episcopal Road
Berlin CT 060377
P: 800.346.7707 | F: 800.541.1073
www.mckinneyhinge.com | dss-orders@assaabloy.com

McKinney is a brand associated with Corbin Russwin, Inc., an ASSA ABLOY Group company. Copyright © 2017, Corbin Russwin, Inc. All rights reserved. Reproduction in whole or in part without the express written permission of Corbin Russwin, Inc. is prohibited.