

MCK-14HD 95" Full Mortise Short Leaf Inset HD

The global leader in door opening solutions

DO NOT SCALE
FOR ILLUSTRATION PURPOSES ONLY
DIMENSIONS: INCHES (MM)

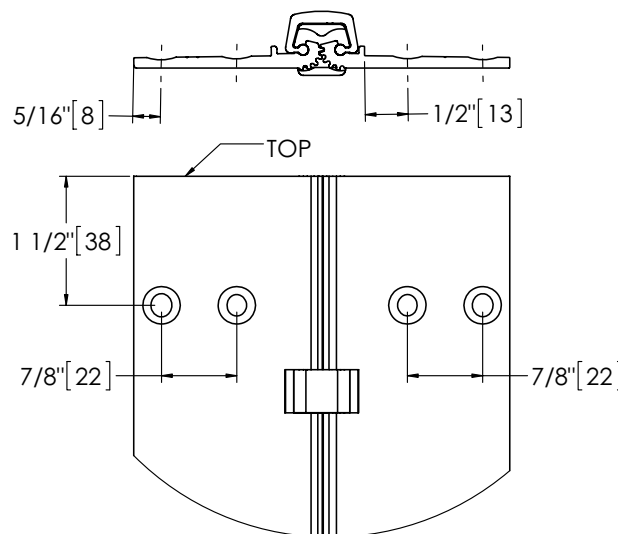
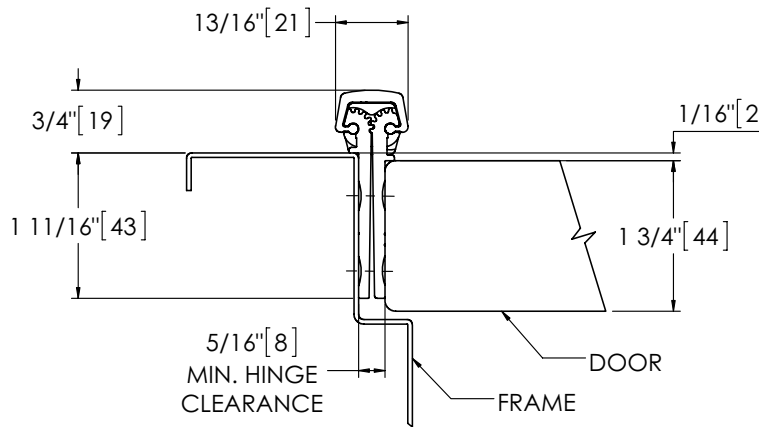
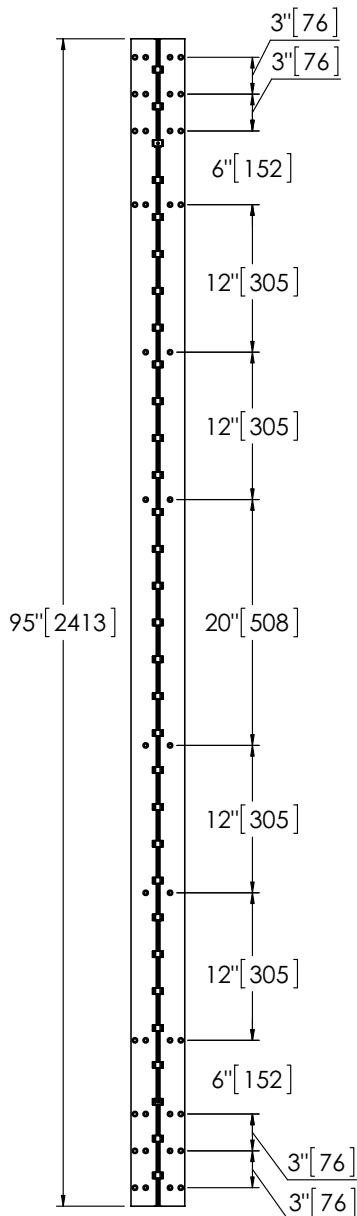

Template 648-18

Effective date: June 2018

Supersedes: All Previous

McKINNEY Template Edge Mounted Continuous Aluminum Geared Hinge MCK-14HD is made to conform to this drawing.

McKINNEY MCK-14 hinge can be supplied with Electric Functions - See Electrified Hinge section.

Machine Screw Size:
Custom #12-24 x 1 1/16" FHUC, self drilling

Hinges are listed for fire applications up to 90 minutes without special preparation; for 3 hour openings using hollow metal doors and hollow metal frames on masonry/drywall, fire pins (supplied separately) must be used.

**** CAUTION ****
Due to Frame Installation Variations, Pre-drilling For Fasteners IS NOT Recommended