

**medeco**<sup>®</sup>

**ASSA ABLOY**

ASSA ABLOY, the global leader  
in door opening solutions



**2019**

**MEDECO PRODUCT CATALOG**

U.S. EFFECTIVE  
FEBRUARY 1, 2019

CANADA EFFECTIVE  
JUNE 3, 2019



# Table of Contents

## Medeco

Key Control.....	4
How to Order.....	8
Online Tools.....	9
Shipping and Returns Policy.....	11
Warranty.....	13
Architectural Specifications.....	14
Professional Services.....	16

## Intelligent Key Systems

<b>Medeco XT.....</b>	<b>20</b>
Programming and Management.....	21
Intelligent Keys.....	23
Secure Programming and Charging Device.....	24
Access Interface Module (AIM).....	25
Traffic Cabinet Lock.....	26
Rim and Mortise Cylinders.....	27
Dual-Tech Cylinder.....	28
Dual-Tech Cams.....	28
Interchangeable Core Cylinders.....	29
Key-In-Knob/Lever Cylinders.....	29
Padlocks.....	31
Cam and Utility Cylinders.....	32
International Cylinders.....	33
Specialty Cylinder Formats.....	33
Keys and Accessories.....	34
Programmers and Accessories.....	35
<b>M<sup>3</sup> CLIQ®.....</b>	<b>36</b>
Rim and Mortise Cylinders.....	37
Key-In-Knob/Lever Cylinders.....	37
Interchangeable Core Cylinders.....	39
Deadbolts.....	40
Padlocks.....	41
International Cylinders.....	42
CLIQ™ CONNECT Keys.....	43
CLIQ™ Go.....	44
Keys and Accessories.....	45
Programming and Management.....	46
<b>Classic CLIQ®.....</b>	<b>48</b>
Rim and Mortise Cylinders.....	49
Key-In-Knob/Lever.....	49
Interchangeable Core Cylinders.....	52
Padlocks.....	52
Deadbolts.....	53
Cam and Utility Cylinders.....	54
Retail/Showcase Locks.....	54
International Cylinders.....	55
Vending Cylinder Formats.....	55
Keys and Accessories.....	56
Programming and Management.....	57

## Mechanical Technologies

Medeco <sup>3</sup> Technology.....	58
BiLevel Technology.....	59
Medeco X4 Technology.....	60
Medeco <sup>B</sup> Technology.....	61

## Mechanical Products

Rim and Mortise Cylinders.....	63
Key-In-Knob/Lever Cylinders.....	74
Interchangeable Cores.....	96
LFIC.....	96
SFIC.....	104
Medeco T21 Key Management System.....	110
International Cylinders.....	111
Deadbolts.....	141
Maxum.....	142
Residential Maxum.....	154
Padlocks.....	156
Protector II Series.....	158
System Series.....	161
Hockey Puck.....	172
G8R.....	173
Cam/Cabinet and Switch Locks.....	174
Cam Locks.....	175
Removable Core Cam Locks.....	179
Cabinet Locks.....	185
Plunger Locks.....	187
Micro Switch Lock.....	188
Rotary Switch Lock.....	190

## Accessories

Keying Charges.....	192
Keys.....	194
Pin Kits.....	198
Components.....	201
Tools and Fixtures.....	202
Key Machines.....	203
Software and Support.....	203
<b>Product Index.....</b>	<b>204</b>
<b>Finishes.....</b>	<b>213</b>

## Key Control

### Medeco's Approach

The security of any locking system is dependent upon two very important factors. The first is protection against attacks such as picking, drilling, bumping, and forcing. The second is the ability to control duplication of existing keys. Historically, unauthorized key duplication has played a major role in compromising even the most sophisticated security systems. Anyone with even temporary access to original keys has no problem getting duplicates made for their own use if the keys and key blanks are not patent protected. Even stamping "Do Not Duplicate" on a key merely warns someone not to copy the key – it is not a promise of legal protection or enforcement. The only way to ensure that keys cannot be copied without the consent of the owner is a key system with patent-protected keys.

### ***Medeco has counteracted the key control problem by doing three things:***

1. Medeco manufactures cylinders which use keys that must be made on special key cutting machines. These machines are capable of reproducing the angled cuts and critical tolerances necessary to produce a workable Medeco key, and are not found at general hardware stores.
2. Medeco only sells its high-quality, precision machined cylinders and locks to security industry professionals. Every restricted Medeco key blank is custom coined and tracked by Medeco to identify it as an authorized key blank, which protects against unauthorized copies.
3. Medeco invests heavily in research and development to establish strong patents and legal agreements to protect its locks and key blanks from unauthorized distribution or manufacture.. As a result, Medeco can litigate to protect its rights and the security of its customers.

### A Key Control Program That's Right for You

Not every user has the same key control needs. That's why Medeco has designed different key control programs and different keyways to meet a wide range of security specifications and key access requirements.



### Dealer/Service Center

This program offers instant local access to additional keys with protection from unauthorized copying. Consumers simply return to the security provider from which they purchased the locks. This security professional will have a signature card on file completed by the owner of the key system at the time the system was installed.



### Card Programs

Authorized individuals are issued a card with embossed control data and a space for their signature. To obtain key duplicates, card holders present the card to any participating Medeco security professional. The data and signature will be verified and a key can then be issued. A card program is ideal for residences or businesses that need keys available nationwide.



### End User Program

The End User program is for large facilities that have their own locksmith on staff and that want to produce Medeco keys themselves. This program offers individualized control over key duplication procedures.



### Commercial Program

The Commercial Program is designed for users who use Medeco locks primarily for protection against picking, drilling and other forms of physical attack. Keys may be obtained from any Medeco locksmith without specific authorization.



### Factory Program

Additional keys are only available from the Medeco factory and only with the proper signature.









### Intelligent Key Systems

Intelligent Key Systems utilizing eCylinders allow the end user the ability to control their own system to electronically change access to any cylinder or key onsite and to obtain audit information.

Visit our website at [www.medeco.com](http://www.medeco.com) for more information on all key programs.



# MEDECO® KEY CONTROL PROGRAM REFERENCE CHART

- M3** = Medeco<sup>3</sup> patent expiration date: 2021.
- BIA** = Biaxial patent expiration date: 2005. Upgrading to Medeco<sup>3</sup> recommended.
- ORG** = Original patent expiration date: 1985. Upgrading to Medeco<sup>3</sup> recommended.
-  = Permission for copying keys is obtained by presenting a signed authorization card, which is matched to proper identification.
-  = Permission for copying keys is provided by identification and signature verification, which must be presented to either the original locksmith provider or the facility manager.
-  = Keys can be cut on-site by dealers or end-users that are contracted to participate in the respective key program.
-  = Keys are ordered locally and cut at a regional service center and then shipped back to the dealer.
-  = Keys are cut at the Medeco factory and shipped to dealer. Authorization is provided by signature verification.
-  = Medeco recommended high security—UL 437 Listed, ultimate Grade 1 strength, and A156.5-2001 and A156.30 Level A Certified.

## MEDECO<sup>3</sup>® IS RECOMMENDED BY SECURITY PROFESSIONALS AS THE LEADER IN HIGH SECURITY AND PATENTED KEY CONTROL.

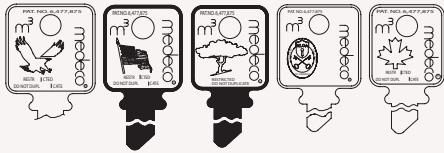

### Medeco<sup>3</sup> Dealer

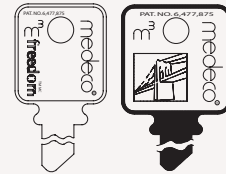

### Freedom® / Gotham™

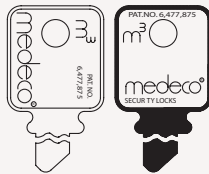

### DND / NYC

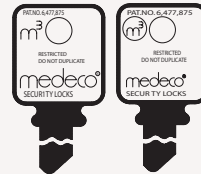

### Medeco<sup>3</sup> End-User

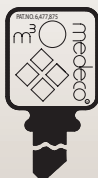

### Medeco<sup>3</sup> Factory Restricted



**BIAXIAL KEYS**



**Biaxial® Dealer**

**BIA**

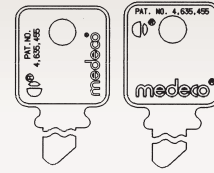

**Gold (GLD) / Platinum (NUK)**

**BIA**

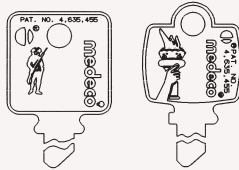

**Patriot® / Liberty™**

**BIA**



**Biaxial® End-User**

**BIA**



**Biaxial® Factory Restricted**

**BIA**



**ORIGINAL KEYS**



**Original® Dealer**

**ORG**



**SKY**

**ORG**



**Original® End-User**

**ORG**



**Original® Factory Restricted**

**ORG**



### COMMERCIAL KEYS



**Commercial**  
(Original & Biaxial Version)

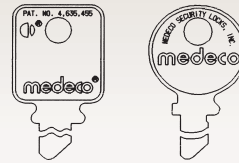

**OEM / Other**

Medeco keys not found on this chart are most likely from an original equipment manufacturer using Medeco products. Return to the original manufacturer of the product for duplicate keys.

### MEDECO X4 KEYS

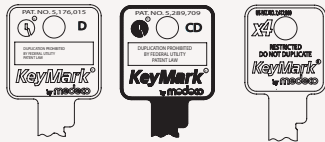

**Medeco X4 Dealer**

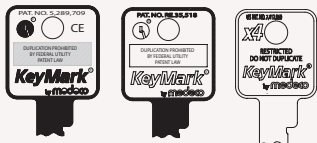

**Medeco® KM/X4 End-User**







**Medeco KM Silver      Medeco X4 Chrome**



**Medeco<sup>B</sup>**

Dealers do not need a contract to purchase Medeco<sup>B</sup> SFIC Cores. Keys and Cores are available through Medeco and authorized distributors.

- X4** = Medeco X4 patent expiration date: 2030.
- KM** = KeyMark patent expiration date: 2011.
-  = Permission for copying keys is obtained by presenting a signed authorization card, which is matched to proper identification.
-  = Permission for copying keys is provided by identification and signature verification, which must be presented to either the original locksmith provider or the facility manager.
-  = Keys can be cut on-site by dealers or end-users that are contracted to participate in the respective key program.
-  = Keys are ordered locally and cut at a regional service center and then shipped back to the dealer.
-  = Keys are cut at the Medeco factory and shipped to dealer. Authorization is provided by signature verification.

## Submitting Orders to Medeco:

*For greater efficiency and to create the best ordering experience, orders may be submitted through three order channels: eBusiness, Email or Fax.*



### eBusiness Order Channel

*Benefit:* Immediately transmit clean orders to reduce entry time to speed up delivery.

#### EDI

EDI stands for Electronic Data Interchange. It's the easiest method to use for the transmission of orders. Orders are generated directly from your ERP system and sent directly into Medeco's order entry system. EDI allows for instant and accurate transmission.

#### Medeco WebShop

Online Order Entry is a convenient web-based form which allows customers to easily use drop-down menus and filtering options to assist with product search and selection. A perfect part number is selected every time!

Visit <http://extranet.assaabloydss.com> to access.

### Email Order Channel

*Benefit:* Immediately submit your orders directly into our Digital Filing System to speed up processing time.

**In USA: [orders.medeco@assaabloy.com](mailto:orders.medeco@assaabloy.com) , In Canada: [orders.medeco.ca@assaabloy.com](mailto:orders.medeco.ca@assaabloy.com)**

Emailing orders in USA: [orders.medeco@assaabloy.com](mailto:orders.medeco@assaabloy.com) ; in Canada: [orders.medeco.ca@assaabloy.com](mailto:orders.medeco.ca@assaabloy.com) allows customers to submit purchase orders directly into Medeco's Digital Filing System. Once the order is submitted by email, an automatic email notification is sent stating the order has been received by Medeco, thus ensuring the order was not lost in transmission.

### Fax Order Channel

*Benefit:* Immediately submit orders directly into our Digital Filing System to speed up processing time. Typed submissions receive EDI benefits of faster processing and accuracy.

**USA Fax: 800.421.6615**

**Canada Fax: 888.263.3326**

Faxing orders in USA: 800.421.6615 ; Canada: 888-263-3326 allows customers to submit purchase orders directly into Medeco's Digital Filing System. If a faxed order is typed versus handwritten, Medeco will be able to use an internal tool to send typed, faxed orders through the EDI portal to create faster order processing and reduce entry errors.

### Special Pricing (SP) and Quotations

The SP or quote number must be referenced on the order, when submitted for processing. Any invoiced order that has the incorrect discount applied to it and did not have the SP or quote number written on the order will have a service fee of \$100.00 net DEDUCTED from any sales credit issued for the difference in the discount.



Medeco is continually developing online resources to make ordering, system management and training quicker and easier than ever. Ask your Medeco representative for more information or contact:

**In USA:** Customer Care Department at 877-633-3261, or [customerservice.medeco@assaabloy.com](mailto:customerservice.medeco@assaabloy.com).

**In Canada:** Customer Care Department at 888-633-3264, or [customerservice.medeco.ca@assaabloy.com](mailto:customerservice.medeco.ca@assaabloy.com).

### Medeco WebShop

The new online order entry site for Medeco products, Medeco WebShop is the quickest method to submit orders directly to the Medeco factory. It makes ordering your favorite Medeco products easier than ever before! Products are searchable by technology and type, with complete descriptions and photos. Save time by creating custom lists of commonly ordered products.

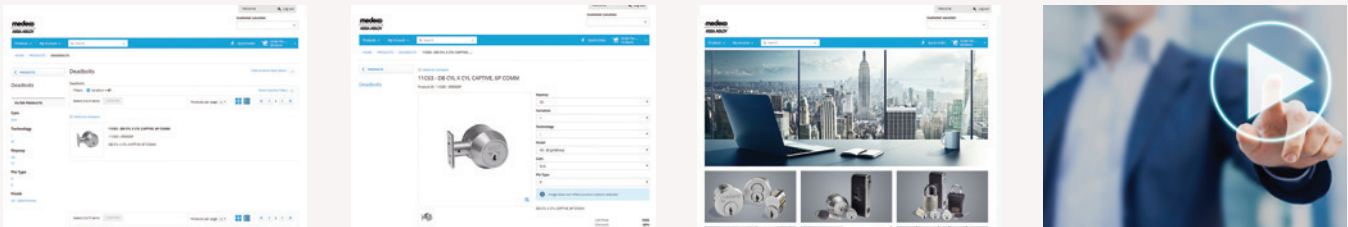

### Medeco Key System Design Studio

The Medeco Key System Design Studio is an online portal that has taken the complexity out of master key design. Users simply answer a few questions about the project's system parameters and system management capabilities. Each click walks the user through the entire process: plan design, products ordering, and processing through Medeco. The Key System Design studio saves time by eliminating questions and missing information.

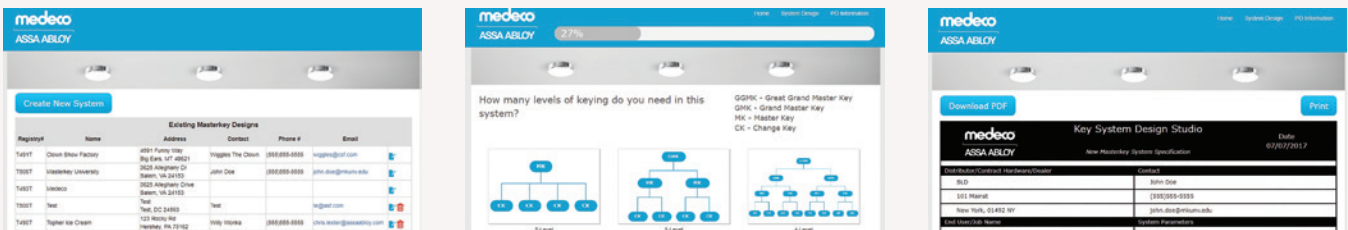

- Eliminates question orders and missing information
- Speeds up master key order and system processing
- Provides real-time master key assistance via integrated chat with a Medeco Master Key Specialist
- Allows users to manage their submitted master key systems

Both the Medeco Key System Design Studio and Medeco WebShop are located on the ASSA ABLOY DSS Extranet, in the same location as crcDash. If you do not have a DSS Extranet login, please contact the Medeco Customer Care department for a registration form today!

**In USA: Phone:** 877-633-3261 • **Email:** [customerservice.medeco@assaabloy.com](mailto:customerservice.medeco@assaabloy.com)

**In Canada: Phone:** 888-633-3264 • **Email:** [customerservice.medeco.ca@assaabloy.com](mailto:customerservice.medeco.ca@assaabloy.com)

### Letter of Authorization Digitization

The Record of Authorization (ROA) portal allows an end-user to authorize another purchaser on their behalf, instantly. The ROA portal allows an authorized end-user to sign, manage, and authorize ordering restricted Medeco products such as key blanks and pinned cylinders with a few clicks of a button. The ROA portal is the quickest way to reduce processing time with Medeco's authorization requirements. For more information visit: [roa.medeco.com](http://roa.medeco.com).

### Training

Factory certification is offered on a regular basis at Medeco's Salem, Virginia facility and at other facilities around the United States and Canada.

Medeco® offers factory certification classes with a comprehensive study of our patented Medeco<sup>3</sup> technology used in Medeco® cylinders. Additionally, we offer certification classes for our Medeco X4®, and M<sup>3</sup> CLIQ and Medeco XT product lines.

Overviews of other Medeco® technologies and product lines are available online at the ASSA ABLOY Academy. Here you will find installation videos, product overview videos, sales technique videos and many other tools to assist you. To visit the online University, please visit [www.assaabloyacademy.com](http://www.assaabloyacademy.com). If you do not already have an account, you will need to register for one. Registration and online classes are complimentary.

**Provide All of the Needed Information to Avoid Delays!**  
**Use the Medeco Checklist to Submit Clean Orders for Faster Processing**

### Medeco Order Checklist for All Orders

- |  |  |
|--|--|
| <input type="checkbox"/> Account Number            | <input type="checkbox"/> Base Part Number    |
| <input type="checkbox"/> Purchase Order Number     | <input type="checkbox"/> Finish              |
| <input type="checkbox"/> Billing Address           | <input type="checkbox"/> Keyway              |
| <input type="checkbox"/> Shipping Address          | <input type="checkbox"/> Cam/Tailpiece       |
| <input type="checkbox"/> Shipping Instructions     | <input type="checkbox"/> Keying Instructions |
| <input type="checkbox"/> Special Pricing/Quote ID* | <input type="checkbox"/> Quantity            |
| <input type="checkbox"/> Special Instructions      |  |

\*The SP or quote number must be referenced on the order.

Any invoiced order that has the incorrect discount applied to it and did not have the SP or quote number written on the order will have a service fee of \$100.00 net DEDUCTED from any sales credit issued for the difference in the discount.

### Master Key Checklist

- |  |  |
|--|--|
| <input type="checkbox"/> <b>New Master Key System:</b> | <input type="checkbox"/> <b>Existing Master Key System</b> |
| <input type="checkbox"/> Master Key Request Form       | <input type="checkbox"/> Registry Number                   |
| <input type="checkbox"/> Name of End User              | <input type="checkbox"/> Name of End User                  |
| <input type="checkbox"/> Electronic Key Schedule       | <input type="checkbox"/> Electronic Key Schedule           |
| <input type="checkbox"/> Serialization Instructions    | <input type="checkbox"/> Serialization Instructions        |
| <input type="checkbox"/> Stamping Instructions         | <input type="checkbox"/> Stamping Instructions             |
| <input type="checkbox"/> Letters of Authorization      | <input type="checkbox"/> Letters of Authorization          |

### M<sup>3</sup> CLIQ™ Checklist

- |   |   |
|---|---|
| <input type="checkbox"/> <b>New System:</b>     | <input type="checkbox"/> <b>Existing System</b> |
| <input type="checkbox"/> End User Name          | <input type="checkbox"/> System Number          |
| <input type="checkbox"/> End User Email Address | <input type="checkbox"/> End User Name          |
| <input type="checkbox"/> Time Zone              | <input type="checkbox"/> End User Email Address |
|   | <input type="checkbox"/> Time Zone              |

### Medeco XT Checklist

- |   |   |
|---|---|
| <input type="checkbox"/> <b>New System:</b>     | <input type="checkbox"/> <b>Existing System</b> |
| <input type="checkbox"/> End User Name          | <input type="checkbox"/> System Number          |
| <input type="checkbox"/> End User Email Address | <input type="checkbox"/> End User Name          |
|   | <input type="checkbox"/> End User Email Address |

### Hybrid Checklist

- Site Code
- Serial Number

**U.S. Customers – Door Security**

Phone: 877-633-3261

Mailing address:

Medeco Security Locks, Inc.

P.O. Box 3075

Salem, VA 24153

Attn: Door Security Customer Service

Fax: 800-421-6615

To submit orders:

orders.medeco@assaabloy.com

To email Customer Service:

customerservice.medeco@assaabloy.com

Hours of operation:

Monday – Friday, 8:00 a.m. – 8:00 p.m. ET

**Canada Customers**

Phone: 905-532-4970

Toll-free (in Canada only) 1-888-633-3264

Mailing address:

Medeco Canada

160 Four Valley Drive

Vaughan, ON L4K 4T9 CANADA

Fax: 905-532-4971 or

1-888-263-3326 (in Canada only)

E-mail: orders.medeco.ca@assaabloy.com

Hours of operation:

Monday – Friday, 8:00 a.m. – 4:30 p.m. ET

**Customers Outside the U.S. and Canada**

Phone: 540-380-1603 or 540-380-1741

Mailing address:

Medeco Security Locks, Inc.

P.O. Box 3075

Salem, VA 24153

Attn: International Customer Service

E-mail: export@medeco.com

Hours of operation:

Monday – Friday, 8:00 a.m. – 5:00 p.m. ET

# Medeco Shipping & Returns Policies

**The Medeco Commitment**

Medeco strives to maintain consistent pricing at the lowest possible level. However, unexpected increases may cause changes in our pricing. Therefore, all published prices are subject to change without notice and are not guaranteed. All shipments will be made at prices prevailing at time of shipment. As much as we try to publish error-free material, we reserve the right to correct typographical, clerical, editorial, pricing, quantity, or any other errors in this or any publications produced by Medeco Security Locks, Inc. without prior written notice or disclaimer.

**Shipping Times:**

Many items are available for shipment within 7 workdays, and most items will be shipped in 10 days or less. Unless otherwise agreed to in writing, all Products are shipped F.O.B. Medeco's location. Medeco reserves the right to deliver in installments.

**Shipping Charges:**

For most U.S. customers, published freight rates will apply. Contact Medeco Customer Service for more information about Medeco's shipping and handling charges.

**Customers Outside the U.S.:**

Due to specific taxes, import/export fees, and exchange rates, pricing and shipping will vary from U.S. list prices for customers in Canada and elsewhere outside the United States.

**Note:** Some products may not be available in Canada as well as some of the programs offered in this price book may differ between the USA and Canada. Please contact your sales representative for more information.

**Product Returns:**

Medeco accepts product returns if the product is defective from a manufacturing flaw. If you need to make a return, fill out the enclosed RGA Form and fax it to:

**In USA:** 800-421-6615

**In Canada:** 888-263-3326

or email to:

**In USA:**

orders.medeco@assaabloy.com

**In Canada:**

orders.medeco.ca@assaabloy.com

The RGA Number must be visible on the outside of any package returned to Medeco.

**Damaged Goods:**

All orders are carefully filled, checked, and packaged. However, on rare occasions, a package may be damaged in transit. If this occurs, please make note of it on the delivery receipt before signing. To return merchandise that was damaged during the shipping or delivery process, call Medeco Customer Service.

**Partial Shipments:**

If all items on your order are not available at the time your order is processed, you must specify whether you want Medeco to hold the shipment until it is complete or send partial shipments as items are available. Orders received without specific shipping instructions will be filled at the discretion of Medeco.



**ASSA ABLOY**

**Returned Goods Authorization Request**

Medeco USA:  
3625 Alleghany Drive  
Salem, VA 24153  
Phone: 800-839-3157 Fax: 800-421-6615

Medeco Canada:  
160 Four Valley Drive  
Vaughan, ON L4K 4T9  
Phone: 888-263-3326 Fax: 888-263-3326

Date \_\_\_\_\_

RGA #

Account #

Customer Name

Contact Phone

Ship Address

Contact Fax

City, State, Zip

Sales Rep

Contact Name:

Original Order # or Cust. PO#	Line no.	Quantity	Product (Complete Part Number)	Detailed Reason for Return

\$

**If Master Key product, provide required information:**

\*Registry Number #:

**If CLIQ product, provide required information:**

\*CL #:   
 \*\*End User's Name:   
 \*\*\*End User's Email:   
 \*\*\*\*Time Zone:

Key Markings:   
 Cylinder Markings:

**If Medeco XT product, provide required information:**

\*CO #:   
 \*\*End User's Name:   
 \*\*\*End User's Email:

**Action Requested:**

Return product for FULL credit; no re-order.

Replace product returned on this RGA with the product listed below:  
 (RGA Number is new purchase order no.)

Quantity	Complete Part Number	Quantity	Complete Part Number

Customer's Error or out of Warranty:

Return product for credit less re-stock fee (50%); customer pays freight.

Explain reason for request:



## Medeco® Warranty for Mechanical & Electromechanical Products

Medeco Security Locks Inc. (“Medeco”) warrants to the original purchaser of a Medeco branded lock, lock cylinder, or electromechanical door hardware product (referred to collectively as “Product”) to be free of defects in material and/or workmanship for a period of two (2) years from the date of original purchase for use. This Warranty may also apply to other specific products. For additional Warranty information or Warranty claim service, contact Medeco Customer Service at (800) 839-3157 or in Canada (888) 633-3264.

In the event of a defect in material or workmanship during the Warranty period, Medeco will repair or replace (at its option) the Product under the conditions of this Warranty, this action being the sole remedy available to the purchaser under this express limited Warranty.

### Limitations, Exclusions and other Rights:

- a. Medeco disclaims liability for implied warranties, including but not limited to those of merchantability or fitness for any particular purpose.
- b. Medeco disclaims liability for indirect, incidental or consequential damage at any time.
- c. This Warranty gives specific legal rights, and a buyer may also have other rights that may vary from state to state. Some states do not allow limitations on indirect, incidental, and consequential damages or implied warranties so that the above limitations may not fully apply.
- d. Medeco keyblanks are made from a special nickel silver alloy. Medeco warrants its mechanical keys against defects in workmanship or breakage for the life of the Product. Electronic keys are covered for one (1) year against breakage. Bitted Medeco keys must be precisely cut to exact angles and depths, and require special duplication. This Warranty shall be void and Medeco disclaims liability of any kind in the event any key other than a genuine Medeco key has been used with the Product or that the key has been cut on any machine other than a Medeco or Medeco-approved key cutting machine.
- e. Medeco shall not be held responsible for product complaints or product damage arising from, in its sole judgment, and absence of user training, improper installation, failure to provide normal maintenance, extreme environmental conditions, use rates in excess of the industry standards defined for the type of product, use of incompatible parts or products not made or authorized by Medeco, or application of force not resulting from normal use.
- f. Unless otherwise specified by separate warranty, finishes are warranted for a period of two years following purchase for use. This finish Warranty shall be considered void after installation if, in the sole judgment of Medeco, the damage to the finish is the direct result of extreme climatic conditions, chemical or abrasive actions.

## Medeco<sup>3</sup> Suggested Architectural Specifications

Furnished cylinders must provide the capability of a high security, patented, pick- and attack-resistant design with angled key cuts, rotating tumblers, a keyway side bitting, and a slider mechanism. Cylinders shall provide the option of certified listing to Underwriters Laboratories Listed Standard--UL437--for key locks. Cylinders shall provide the option of certification under American National Standards Institute (ANSI)/Builder's Hardware Manufacturer's Association (BHMA) certification A156.30 2007 (High Security Cylinders) "Levels M1AAAM," and ANSI/BHMA A156.5 2010 "Grade 1."

The furnished key system must allow the capability to combine within the same key system, and using the same patent-protected keys, high security rated cylinders as described above, with non-high security rated cylinders providing greater economy within a single master key system. Furthermore, the furnished key system shall allow the incorporation of software-controlled, electro-mechanical cylinders ("eCylinders") with the capability of utilizing the same credential and a single key system controlling both mechanical cylinders and eCylinders.

All cylinders with the high security option shall incorporate three locking elements, consisting of a slider mechanism, a sidebar mechanism with tumbler rotation, and pin tumbler elevation. The critical parts of the locking mechanism such as pins, shear line, sidebar, and slider mechanism shall be afforded extra protection from drilling and other forceful attack by the strategic placement of hardened steel inserts in a minimum of 7 possible locations within the cylinder. The lock tumblers shall combine a dual-axis action, with one axis utilized for pin tumbler rotation and the other axis utilized for positioning key cuts. Randomly selected tumbler pins shall incorporate a hardened steel insert for additional drill resistance.

All cylinders with the non-high security option shall incorporate two locking elements, consisting of a slider and sidebar combination, and conical tip, pin tumbler elevation.

The locking system is to be furnished in a restricted key section for which key blanks are not made available from the manufacturer's factory or any other source by uncontrolled distribution methods. The key and cylinder must have utility patent protection so as to hinder unlawful or unauthorized key duplication. Such patent protection shall be afforded in the United States of America, Canada, Mexico, and a plurality of other countries. The keys and key blanks must be capable of being furnished to allow an upgrade to a dual mechanical and electronic credential by the single exchange of a field removable key bow. The key blank thickness should be no less than .125" (one hundred twenty-five thousandths).

The manufacturer shall have the capability of establishing a key system with a minimum of six angled cuts in six possible pin positions with the capability of two distinct positions of cut per pin chamber, if required by the parameters of the system. The manufacturer shall have the capability of producing a patent-protected keying system in either of two distinct and different keying specifications and pinning specifications. The system shall be capable of incorporating a key which is capable of more than one bitting per position to expand master keying and key changes. The key shall also incorporate the capacity to include twelve possible side bittings along the key blade located on two different planes or surfaces of the key. The system shall also have the capability to provide a single master key with over 1,000,000 (1 million) usable, non-interchangeable change keys in a single profile.

The cylinders shall be immediately rekeyable to new combinations or a new system at any time desired and shall be serviceable on location in the field. Installation of cylinders shall require no modification to U.S. manufactured commercial-grade locksets.

The locking system established for this project shall be proprietary, and the owner will furnish the manufacturer a list of those persons and their signatures that will be authorized and required to order additional pinned materials or duplicate keys. Orders not bearing authorized signatures shall not be filled.

All master keys and bitting lists for this project shall be sent using appropriate shipping carriers from the factory directly to the owner. Prior to shipment of keys, the owner shall verify, in writing, preference for shipping carrier and destination.

## Medeco X4 Architectural Product Specifications

Cylinders shall be of the knob, rim, mortise, or interchangeable core type. All cylinder components (excluding tumbler pins) shall be constructed of machined extruded brass. All cylinders, cores and housings shall be available in all standard architectural finishes and shall match the cylinder housing and lock and door hardware. Further, cylinders and housings shall be plated, not scalped with the appropriate finish.

Cylinders to be of the 6- or 7-pin tumbler type, providing the maximum unique, non-interchangeable key combinations respectively. All cylinders shall incorporate two locking elements consisting of pin tumbler elevation and a slider mechanism. Further expansion of a master key system shall be available by use of additional multiplex keyways. Cylinders shall not lose any combinations due to MACs (maximum adjacent cut) loss.

All cylinders shall use a .150" space dimension between tumbler pin chambers and shall be capable of using industry-standard tumbler pins. Cylinder shall contain standard pins, a portion of which (both bottom and top pins) shall be spooled to resist pick attacks.

All non-I/C rim and mortise cylinders shall be so constructed to use threaded set screws, not staked covers or caps, to cover each individual tumbler pin chamber.

All cut keys, key blanks and cylinders (knob, rim, mortise, and interchangeable core-type) shall be so constructed to be capable of being keyed in the same system, allowing the convenience of one master key to operate all types of listed cylinders. Further, the key or key blank's tip shall be so constructed to correctly locate the bits of the key beneath the proper chamber of an interchangeable core cylinder by locating against a key stop on the rear core. Additionally, the key or key blank's shoulder shall serve as a stop to correctly locate the bits of the key beneath the proper plug chamber of rim, mortise and knob-type cylinders by locating against the front face of the cylinder. The key blank thickness should be no less than .093" (ninety-three thousandths).

All cut keys and key blanks shall be utility patented and controlled by a contract between the end user and the manufacturer. Key blanks for this project shall be delivered directly from the factory to the end user unless otherwise requested in writing by the end user.

All keys must be capable of being configured to allow an upgrade to a dual mechanical/electronic credential by the simple exchange of a field-removable key bow.

The key shall incorporate the capacity to include eight possible side bittings along the key blade, located on two different planes or surfaces of the key.

All key blanks shall be custom coined with the end user's name or other unique identification mark. All cut keys and key blanks are to be constructed from nickel silver.

All keys shall be capable of being cut by a punch machine that originates the exact cut in the key from the code sheet, instead of using patterns.

Cylinders shall be immediately rekeyable to new combinations or a new system at any time desired and shall be serviceable on location in the field. Installation of the cylinders shall require no modifications to U.S. manufactured commercial-grade locksets.

The locking system established for this project shall be proprietary, and the owner will furnish the manufacturer a list of those persons and their signatures that will be authorized and required to order additional pinned materials or duplicate keys. Orders not bearing authorized signatures will not be filled.

All cylinders, cores, housings, keys and key blanks shall be made in the USA.

# Medeco®

## Professional Services for Intelligent Key Systems

To achieve optimum performance of your new intelligent Key System, Medeco recommends professional design and implementation services. Services include system planning, system deployment, team training and on-going support.

### Medeco Professional Services: Making the most out of your investment



Over our 50 year history, Medeco has established a reputation for developing high-quality products that provide unparalleled security. Yet, high-quality products alone do not guarantee a successful deployment. To achieve optimum performance of your new intelligent Key System, Medeco recommends professional design and implementation services.

**Medeco Professional Services includes a variety of offerings that will help you gain additional value from your technology investment. Professional Services include:**

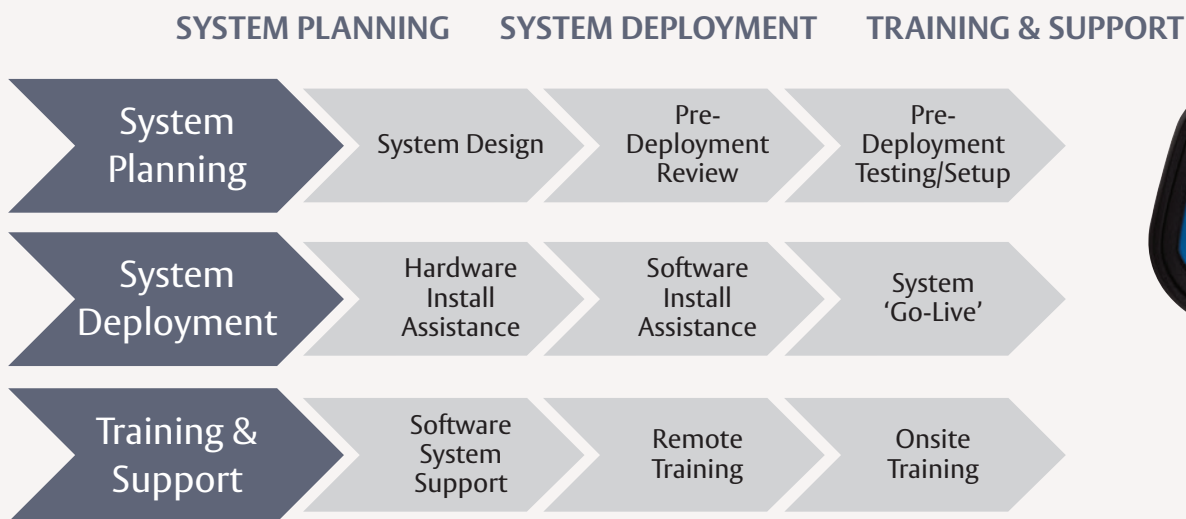



# Professional Services – Intelligent Key Systems

## System Planning Services



Medeco Professional Services offers consulting services that leverage industry best-practice to plan, scope and help design Medeco solutions that meet your organization compliance, security and risk management needs. Our consulting services packages have been designed to be delivered under the leadership of a dedicated project manager.

Remote Planning Support	SW-501Remote	\$250.00 NET/hr 1 hour minimum
<ul style="list-style-type: none"> <li>• System Design Assistance</li> <li>• Hardware Requirements</li> </ul>	<ul style="list-style-type: none"> <li>– Ensure that your system is designed with your current and future interests in mind.</li> <li>– Determine the required hardware to meet your implementation goals.</li> </ul>	
Onsite Planning Support	SW-501Site	\$1,900.00 NET/day plus T&E
<ul style="list-style-type: none"> <li>• Pre-Deployment Meetings</li> <li>• Bench-Top Deployment and Validation</li> </ul>	<ul style="list-style-type: none"> <li>– Live in person coordination of events and timeline planning.</li> <li>– Full functionality testing of hardware in a test environment to ensure complete satisfaction before deployment.</li> </ul>	

## System Deployment Services



The Medeco Professional Services team includes dedicated technical consultants and software engineers who will work closely with your in-house team to assist in the deployment and integration of Medeco solutions and third-party systems. This highly skilled group of systems engineers, integrators and project management experts will oversee the implementation of your new Intelligent Key System from start to finish. All technical complexities and any risks will be identified up front so that your system is designed to grow according to your needs – *now and into the future.*

Remote Deployment Services	SW-502Remote	\$250.00 NET/hr 1 hour minimum
<ul style="list-style-type: none"> <li>• Remote Software Installation</li> <li>• Remote Software Upgrades</li> </ul>	<ul style="list-style-type: none"> <li>– Live online assistance with software installation to ensure complete functionality.</li> <li>– Using our remote access software we will ensure that your software upgrades go without issue, including data conversions.</li> </ul>	
Onsite Deployment Services	SW-502Site	\$1,900.00 NET/day plus T&E
<ul style="list-style-type: none"> <li>• Equipment Configuration</li> <li>• Software Installation / Upgrades</li> </ul>	<ul style="list-style-type: none"> <li>– The assistance you need to get all of your equipment programmed and installed in a timely manner.</li> <li>– No need to worry about software installation, we will be there to perform this task for you.</li> </ul>	

## Training & Support Services

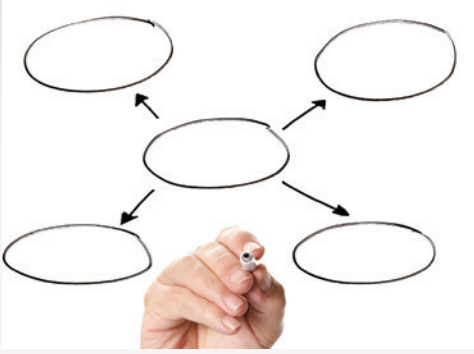

Prior to deployment of your new system, we highly recommend Medeco technical training for your business security team. We offer a variety of customized hands-on training courses to teach your team how to properly operate, customize and support your new Intelligent Key System.

Our experts will work side-by-side with your team to give them a running start, enabling your new system to operate at peak performance on Day One. If there's ever an issue, we'll provide fast, professional and cost-effective assistance by phone, email or online.

The Medeco Professional Services team can also help ensure your system's optimum performance by providing on-site support for long-term engagements on a day-to-day basis.

By providing ongoing expert consultancy, Medeco consultants can expedite troubleshooting and help you define risk mitigation strategies during upgrades of Medeco solutions, allowing you to reduce training costs for your staff.

<b>Enterprise System Support – Silver</b>	<b>SW-504Silver</b>	<b>\$2,613.00 NET Annually</b>
<ul style="list-style-type: none"> <li>• <b>Enterprise System Support – Silver</b></li> </ul>	<ul style="list-style-type: none"> <li>– Software System Support; Extended phone support; 6am – 8am and 5pm – 7pm Eastern, Monday – Friday; 2 hour response time to email requests; Real time phone support; Up to 35 tickets annual</li> </ul>	
<b>Enterprise System Support – Gold</b>	<b>SW-504Gold</b>	<b>\$3,658.00 NET Annually</b>
<ul style="list-style-type: none"> <li>• <b>Enterprise System Support – Gold</b></li> </ul>	<ul style="list-style-type: none"> <li>– Software System Support; Extended phone support; 6am – 8am and 5pm – 10pm EST, 7 Days per week; 1 hour response time to email requests; Real time phone support; Up to 50 tickets annual</li> </ul>	
<b>Remote Training</b>	<b>SW-503Remote</b>	<b>\$250.00 NET/hr 1 hour minimum</b>
<ul style="list-style-type: none"> <li>• <b>Web Based Training</b></li> <li>• <b>Additional Training Based on New Staff/Turnover</b></li> </ul>	<ul style="list-style-type: none"> <li>– Online training setup to meet your planning schedule.</li> <li>– Online training to help you keep up with new staff requirements.</li> </ul>	
<b>Onsite Training</b>	<b>SW-503Site</b>	<b>\$1,900.00 NET/day plus T&amp;E</b>
<ul style="list-style-type: none"> <li>• <b>Hands-on Training</b></li> <li>• <b>Detailed Product Installation Classes</b></li> </ul>	<ul style="list-style-type: none"> <li>– In depth face to face training for our hardware and software applications.</li> <li>– On site classes to train your employees on site specific hardware installation.</li> </ul>	

*All prices are U.S. NET, and not subject to dealer discounting. T&E charges will be quoted upon request.*

**The Medeco Professional Services team will work closely with your company's in-house team to assist with your new system's planning and design, deployment & integration, and on-going support and training. Together, we will ensure that your new Medeco Intelligent Key System is up and running on Day One and operating at peak efficiency.**

**Ask your Medeco sales representative to customize a Medeco Professional Services program for your company's specific needs. Let's make the most of your investment!**

# Professional Services – Mechanical Security

<b>Training Certification Classes</b>	<b>SW-505Site</b>	<b>\$1,900.00 NET/day plus T&amp;E</b>
---------------------------------------	-------------------	--

**Personalized on-site factory technical certification class(es).**

Medeco will conduct field training, demonstrate sample equipment, and certify students on service, maintenance, and support. These are the same certification classes given at factory and trade shows. Various classes available including Medeco<sup>3</sup>, Medeco x4, Medeco XT, CLIQ and Medeco Master Keying — see training catalog for further details.

<b>Master Key Consultation</b>	<b>SW-506Site</b>	<b>\$1,900.00 NET/day plus T&amp;E</b>
--------------------------------	-------------------	--

**Master key system design consultation with a Medeco key system design expert.**

In person key system design consultation with a system design expert. We will assist you in the development of a master key system to meet your design specifications. The system will be uniquely tailored to your facility, resulting in custom Key System Schematics, biting lists and pinning charts.

<b>Key Management Consultation</b>	<b>SW-507Site</b>	<b>\$1,900.00 NET/day plus T&amp;E</b>
------------------------------------	-------------------	--

**Assistance in the design, implementation, customization, and best practices for sound key control.**

Assistance in the design, implementation, customization, and best practices for sound key control products and key management policies and procedures that will minimize liabilities and extend key system lifespan. A key system investment will be maximized by deploying these sound key management practices.

<b>Installation Inspection</b>	<b>SW-508Site</b>	<b>\$1,900.00 NET/day plus T&amp;E</b>
--------------------------------	-------------------	--

**Project product installation and operation inspection and certification.**

# Medeco® XT

## Medeco® XT Intelligent Key System

Medeco® XT is a complete electronic locking system providing controlled access, accountability, physical security, and system management. More than just a way to protect your property, equipment and assets, Medeco XT is also a business tool that can lead to a substantial return on investment. Medeco XT products add a wide variety of intelligent features without compromising on physical security. Attack-resistant design and tamper-proof features provide strong protection against forced entry.



### Audit Accountability

Audit information recorded in both the lock and key shows a time- and date-stamped record of every event, including authorized accesses and unauthorized attempts.



### Uses Existing Hardware

Medeco XT key provides all power to the cylinder, eliminating the need for any hardwiring or power supply. Simply remove the existing mechanical cylinder and install the Medeco XT cylinder.



### Reduces Risk of Lost Keys

Respond quickly to security threats, lost or stolen keys, or personnel changes without the added cost of changing your locks and keys.



### Electronic Scheduling

Keys are electronically programmed to open only specific locks during a designated schedule. Schedules may also contain an expiration point to completely disable the key until it is audited and reprogrammed.



### Medeco Data Dashboard

System audit data is displayed in a new graphical way on the Medeco dashboard. The 'Glances' display consists of several mini-dashboards that provide insight into your system configuration and audit events.



### Data Analytics

The Visual Audit feature of Medeco XT Web manager software converts audit data into a simple graphic dashboard. Security Administrators can see access trends and irregularities at a glance!

### Key Features:

- Small, robust electronic key with stainless steel housing
- Intelligent key holds all access and schedule data
- Rechargeable battery, up to 1,800 openings per charge
- Heavy-duty stainless steel construction
- Stand-alone, network, Web and mobile programming options

### Warranty:

Medeco Security Locks warrants Medeco XT products to be free of defects in material and/or workmanship for a period of two (2) years from date of original purchase (except where noted).

### Product Specifications:

#### Lock / Cylinder Features

- No wiring required—all power provided by the key
- Indoor / outdoor use—stainless steel shell construction
- 2,000 audit events
- Unauthorized key list
- Variety of retrofit cylinder formats



## XT Programming and Management

Medeco® XT Web Manager 2.0 software contains tools that will help you manage your Intelligent Key system efficiently & effectively. Flexible programming including scheduled access, full audit reports and Visual audit to find the issues you need to see quickly.

Our Medeco web-hosted programming offers secure web access, no start-up fees and year-round 24/7 access, making it a cost-effective electronic solution to meet any customer’s needs.



### Medeco XT Web Hosting Service

**These systems hosted by Medeco.** Advantages include: regular software updates so that you are always using the latest functionality, redundant servers for data integrity, scheduled backups for catastrophic event recovery, limitless expansion and data storage to meet your growing needs, and much more...

All Admin functions are handled by trained and certified IT personnel.

Description	Part Number	Annual License Fee
<b>Basic:</b> Designed for smaller systems: Effectively manage your XT Intelligent Key system with all the basic functionality which includes Schedules, Audit, Groups, Data Dashboard & Visual Audit. <b>Limit 750 keyholders.</b>	SW-500301-2	\$721.00
<b>Advanced:</b> Designed for mid-size systems. Adds Remote & Mobile programming & extended schedules to the Basic version. <b>Limit 750 keyholders.</b>	SW-500301-3	\$2,266.00
<b>Enterprise:</b> Designed for large systems. <b>Limit 1500 keyholders.</b>	SW-500301-4	\$3,708.00
<b>Enterprise Plus:</b> Designed for systems larger than (+1500 keys). Options available for purchase include custom server configuration, AWS GovCloud web hosting and Custom Audit archiving schedule.		Call for pricing
<b>Medeco SPC Key Cabinet Software Hosting:</b> Available for all levels except Basic. Host 1-5 Cabinets. (Each additional 1-5 cabinets hosted incurs another annual fee).	SW-500130	\$800.00

*These offerings are billed annually.*

The above Medeco hosted offerings only require a computer capable of running an approved web browser such as Internet Explorer, Firefox, Google Chrome, & Safari. Medeco will provide you with all the login information you need to access your system.

## Medeco XT Self-Hosted Software

**These systems are set up and hosted by the End-User:** End-User is responsible for supplying all necessary hardware & expertise for server set up, maintenance, backups, etc...

See Professional Services section for assistance with configuration and set up of your XT system.

Description	Part Number	One-Time Fee	Annual Fee
<b>*XT Enterprise Self-Hosted Software.</b> For large enterprise systems – includes features like Active Directory integration, Single-Sign-on, etc.	SW-600901-1	\$36,050.00	
<b>Enterprise Self-Hosted Annual Recurring Maintenance Fee –</b> receive software updates and installation support.	SW-600901-1R		\$5,408.00
<b>*XT Advanced Self-Hosted Software:</b> for mid to large systems. Includes features such as Remote and Mobile programming, Visual Audit, Who has Access reporting, etc.	SW-600901	\$16,480.00	
<b>Advanced Self-Hosted Annual Recurring Maintenance Fee –</b> receive software updates and installation support.	SW-600901-R		\$2,472.00
<b>*XT SOLO –</b> Same interface as our XT Web based software but designed for standalone applications. Does not support Remote or Mobile programming.	SW-500301-1	\$958.00	
<b>XT SOLO Software Maintenance Fee –</b> receive software updates and installation support for same	SW-500301-1R		\$191.00
<b>Medeco SPC Key Cabinet Software –</b> self-hosted software to administer the SPC Key Cabinet	SW-601101	\$800.00	
<b>Medeco SPC Key Cabinet Software Maintenance Fee –</b> receive software updates and installations support for same.	SW-601101-R		\$150.00
<i>Maintenance fees are billed annually.</i>			
Self-hosted software purchases entitle the user to a single user license with no annual license fees. However, the software maintenance fee is recommended and provides regular software program updates, maintenance releases, patches, and technical telephone assistance.			

\* Also requires the purchase of a system setup dongle. Part number EA-250059.

# Medeco® XT Intelligent Keys

## Medeco® XT Electronic Locking Systems

The Medeco XT keys are small, robust, convenient and portable. They are built to withstand even the toughest environments.

The Medeco XT keys have dynamic memory which can adjust the number of audit transactions and cylinder access the key can store. Medeco XT keys also utilize a rechargeable battery and can be purchased with a portable charger to ensure you are never locked out due to a dead battery. The key provides feedback to indicate when a charge is required.

There are two key models in the XT line. The 'Slim Line' key is designed for just about every application except those extreme and abusive environments, where the 'Industrial' key is recommended.



### Industrial Key Features:

- Hardened stainless steel housing that will stand up in the toughest environments
- Portable and rechargeable
- Top-mounted LED for convenient access feedback

### Industrial Key Applications:

The XT Industrial key was designed for users that want a small, robust credential that will stand up to the most extreme environments. Tested for drop, shock and temperature extremes, this key is one tough customer!

### Slim Line Key Features:

- Polished, hardened stainless steel frame for strength and durability
- Soft-touch coating
- Dual-LED indicators for greater visibility
- Raised orientation dimples (allow for feeling the orientation of the key) for easier use
- High-capacity memory

### Slim Line Key Applications:

The XT Slim Line key was designed for users that want a small, light credential that will not sacrifice on durability. Created to stand up to all but the most extreme environments but designed to be one of the most portable and desirable keys on the market!

### Bluetooth Key Features:

- Utilizes Bluetooth Smart Technology
- Program keys from any location (within cellular coverage area)
- No need to 'dock' key to program
- LED programming feedback indicates when key is connected to the mobile device
- Works with the latest XT Web Manager software



### Industrial/Slim Smart Key



- Intelligent to access up to 16k locks and store 10k audit events
- Extremely durable – Industrial
- Stainless Steel Industrial
- Stainless Steel and impact resistant plastic – Slim
- Support for remote and mobile programming
- Rechargeable

### Slim Line S Smarter Key



- All the Smart Key features and...
- Higher intelligence to support more advanced features
- Enhanced user experience with faster processing and programming speeds

### Slim Line B Bluetooth Key



- All the Slim Line S features and...
- Program anywhere
- Bluetooth communication built-in
- Smartphone app support
- Immediate upload/download of data (if desired)
- New version with 3 week battery life now available.

See page 32 for additional details and technical information.

# Medeco® XT SPC

## Secure Programming and Charging Device

The Medeco XT SPC ensures XT keys are securely stored and charged, and individually locked in place, thus ready for use when needed. With optional mechanical rings, the device can also be used to secure mechanical keys for greater versatility.



(Photo shows cabinet with door removed to better show the interior).



### XT-SC Features:

- Reduces risk of lost or uncharged keys
- Keys are always ready because they charge while being stored
- XT programming device to allow convenient reprogramming of keys upon removal
- Full audit of key removal and return
- Fully networked software allows multiple levels of oversight
- Battery back-up to ensure key access during power failure
- Durable 16-gauge powder coated metal enclosure
- User specific rights determine access to:
  - One key
  - Multiple keys
  - Multiple keys, but only one can be removed
  - User key port(s) are illuminated to indicate unlocked keys
- Mechanical key override for security door

### Available Options:

- 16, 32 or 64 XT key charging/secure positions
- Biometric, Prox or Barcode readers available for added security (Optional)
- Network/hosted or stand-alone mode. Additional software charges may apply. Please see the Medeco XT Web Software pricing on pages 21& 22 for more details.
- Mechanical fobs + Security Seals for use with mechanical keys (Optional)

### Connectivity/Technical Information:

- TCI/IP Network connection - standard
- Cellular Antenna & Modem, service sold separately (Optional)\*
- 110 V.A.C., 60 Hz. Plug provided, Hard wiring suggested
- 64 pos device: 28-1/8" W X 27-1/8" H X 8" D; 65 lbs
- 32 pos device: 18" W X 18" H X 8" D; 45 lbs
- 16 port dimensions: 18" W X 16.2" W X 8" D; 45 lbs

### Medeco XT Secure Programming & Charging Device:

Description	Part Number	Price
Medeco XT Key Cabinet XT-SPC16 – 16 port Cabinet that charges keys and includes satellite unit with programming port	EA-100197-016	\$18,500.00
Medeco XT Key Cabinet XT-SPC32 – 32 port Cabinet that charges keys and includes satellite unit with programming port	EA-100197-032	\$23,743.00
Medeco XT Key Cabinet XT-SPC64 – 64 port Cabinet that charges keys and includes satellite unit with programming port	EA-100197-064	\$27,106.00

\*Contact your local sales rep for information regarding hardware options.

# Medeco® XT Access Interface Module (AIM)

The Medeco® XT Access Interface Module – known as “AIM” – allows the user to insert their Medeco XT key to trigger actions in other systems. Using both authorized and unauthorized event conditions, users can unlock doors with electric strikes or maglocks, initiate video cameras and bring attention to unauthorized events by triggering access control or alarm panels.



### AIM Features:

- Greatly enhances the capability of the Medeco XT Intelligent Key System
- Key audit tracks events just like an XT cylinder
- Two-person authentication option
- Uses NO – Normally Open and NC – Normally Closed relays to trigger different outputs for Access Granted or Access Denied events
- Can be powered by an XT key or 12-24V Power Supply depending on AIM connection

### Warranty:

Medeco Security Locks warrants Medeco® XT products to be free of defects in material and/or workmanship for a period of two (2) years from date of original purchase.

### Applications:

Medeco XT AIM module can be used with other Access Control or Alarm Panels to trigger authorized and unauthorized event conditions.

### Medeco XT Access Interface Module (AIM):

Description	Part Number	Price
Medeco XT Access Interface Module	EA-100192	\$595.00





# Medeco® XT

## Medeco XT Traffic Cabinet Lock

The Medeco XT Traffic Cabinet Lock helps to secure our critical infrastructure. The Intelligent Traffic System (ITS) cabinets located at every street corner contain hardware that control our cities streets. Cyber attack is a constant threat. A simple retrofit lock solution like the Medeco XT Traffic Cabinet Lock is the quickest, most cost-effective way to add the accountability necessary to help eliminate tampering with the advanced equipment contained within these cabinets.

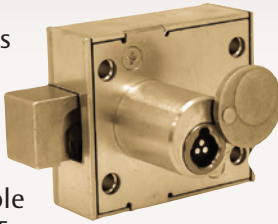

### Medeco XT Traffic Cabinet Lock:

Description	Part Number	Price
Medeco XT Traffic Cabinet Lock*	EA-100221	\$325.00

\* Can be installed in left-hand or right-hand doors.

## Medeco XT Safe Lock

The Medeco XT Safe Lock is a direct replacement for physical security devices that utilize standard mechanical dial combination locks or digital keypad locks. The Medeco XT Safe Lock includes a reader with key port mounted on the outside of the safe door, and is available in one of three XT lock configurations designed to meet a variety of retrofit needs: deadbolt, spring bolt and swing bolt.

Once installed, the Medeco XT Safe Lock will remain in a typically "locked" state securing the safe or other physical security device. To access the safe, a Medeco XT Key is programmed via the Medeco XT Management Software system to only open a specific XT Safe Lock and the key is issued to a specific user. The user inserts the XT Key into the Key Port on the exterior Reader. Power is supplied by the key to the Lock PCB and authentication is initiated with a secure process over the interface communications cable.



An LED provides visual feedback to the user on the current state of the lock. If the Lock PCB and XT Key are in agreement that access is granted, the Lock PCB will provide power to the internal motor/bolt blocker and the user is allowed to rotate the key to unlock the lock. If the XT Key is not authorized, the user will be prevented from unlocking the safe lock.

### Medeco XT Safe Lock:

Description	Part Number	Price
XT Safe Lock – Deadbolt Lock Bundle	EA-100206	\$649.00
XT Safe Lock – Spring Bolt Lock Bundle	EA-100207	\$649.00
XT Safe Lock – Swingbolt Lock Bundle	EA-100208	\$649.00



# Medeco® XT

## Rim and Mortise Cylinders

The Medeco XT Rim and Mortise electronic cylinders are a simple and direct replacement for mechanical Rim and Mortise cylinders. Ideal for loss & liability management with flexible authorization and auditing capabilities.

Respond quickly to security threats, lost or stolen keys, or personnel changes without the added cost of changing your locks and keys. Medeco XT is a complete electronic locking system providing controlled access, accountability, physical security, and system management with no wiring requirements.

Cylinders are available in many popular lengths to fit nearly any application in your office, business and retail applications.



Mortise Cylinder



Rim Cylinder

### Medeco XT Mortise Cylinders

Description	Part Number	Price
1 1/4" Mortise Cylinder	100500 G	\$278.00
1 3/8" Mortise Cylinder	105100 G	\$277.00

### Medeco XT Rim Cylinders

Description	Part Number	Price
Rim Cylinder, horizontal tailpiece	100400H G	\$277.00
Rim Cylinder, vertical tailpiece	100400V G	\$277.00

## Medeco® XT Dual-Tech Cylinder

### For Rapid-Entry Applications

The patent-pending Medeco XT Dual-Tech retrofit cylinder is designed for both accountability and rapid-entry applications. It combines two cylinder technologies – the Medeco XT electronic cylinder and the Medeco X4 mechanical cylinder – in one mortise cylinder housing. Both cylinders operate independently of one another so access is provided using either the XT Key or the X4 key.



Allows fire department emergency facility access using a familiar mechanical key while the XT Intelligent key is used for daily accountability. In multi-family applications, tenants use the mechanical key and maintenance uses XT key for accountability. Ideal for any application requiring a mechanical key override.

### Medeco Dual Tech Cylinder

Description	Part Number	Price
Medeco XT Dual Tech Cylinder, with Medeco X4	490423 G	\$455.00
Medeco XT Dual Tech Cylinder for Arrow/Best	490426 G	\$455.00

## Medeco® XT Dual-Tech Cams

Dual Tech cylinders come complete with a set of 2 specially designed cams, a direct-drive cam operated by the Medeco XT key and an Override cam operated by the Mechanical key. Cam type must be indicated when ordering (Z00, Z01, etc.)

**Important Note:** The standard cams listed on pages 66-67 cannot be used in Dual-tech cylinders.

Replacement cams must be ordered using the chart below. One each direct drive and override cam required per cylinder.

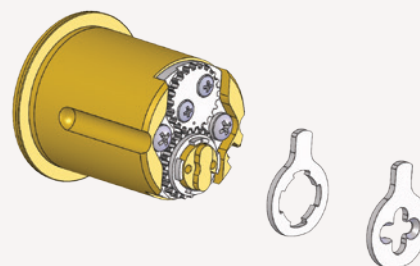

### Medeco Dual Tech Cams

Description	Part Number	Price
Direct Drive Cam – Russwin	CP-100771-Z00	\$8.15
Override Cam – Russwin Type	CP-100781-Z00	\$8.15
Direct Drive Cam – Yale Type	CP-100771-Z01	\$8.15
Override Cam – Yale Type	CP-100781-Z01	\$8.15
Direct Drive Cam – Adams Rite	CP-100771-Z02	\$8.15
Override Cam – Adams Rite Type	CP-100781-Z02	\$8.15
Direct Drive Cam – Sargent	CP-100771-Z20	\$8.15
Override Cam – Sargent Type	CP-100781-Z20	\$8.15
Direct Drive Cam – Schlage	CP-100771-Z34	\$8.15
Override Cam – Schlage Type	CP-100781-Z34	\$8.15

## Interchangeable Core Cylinders

The Medeco® XT Small Format Interchangeable Core (SFIC) is ideal for loss and liability management as a direct replacement for mechanical SFIC cylinders without any hardware modifications. An easy-to-upgrade SFIC solution, ready to install and use without wiring or power supply. Complete SFIC is easily installed or removed to existing hardware with the simple use of a programmed control key. Users can audit keys, program a schedule and track who opens a lock and when – all while eliminating the cost of rekeying mechanical locks. Attack-resistant design and tamper-proof features provide strong protection against forced entry. Well suited for facilities with high turnover of employees, such as fast food restaurants, convenience stores, and similar businesses, but is also suitable for apartments, office buildings, schools, and hospitals.



### Medeco XT Small & Large Format Interchangeable Core

Description	Part Number	Price
Small Format Interchangeable Core (SFIC) Cylinder	EA-100108	\$285.00
Schlage Large Format Interchangeable Core (LFIC) Cylinder*	322201 G	\$283.00
Yale Large Format Interchangeable Core (LFIC) Cylinder* 6 pin	310100 G	\$283.00
Yale Large Format Interchangeable Core (LFIC) Cylinder* 7 pin	310100A G	\$283.00
Sargent Large Format Interchangeable Core (LFIC) Cylinder 6 pin	32G2401	\$285.00
Corbin Large Format Interchangeable Core (LFIC) Cylinder 6 pin	32G2301	\$285.00
Corbin Large Format Interchangeable Core (LFIC) Cylinder 7 pin	32G2801	\$285.00

\* Fits LFIC format housing, but is a one-time installation and not removable

## Key-In-Knob/Lever Cylinders

The Medeco XT Key-in-Knob/Lever electronic cylinder is a direct replacement for mechanical KIK/KIL cylinders and is ideal for loss & liability management. The cylinder requires no wiring to the door and is powered by the Medeco XT rechargeable key. Audit trail, user access schedules and the ability to quickly add or remove a key electronically from a system allow for fast response to security threats, lost or stolen keys, or personnel changes without the added cost of changing your locks and keys. KIK/KIL cylinders are designed for quick retrofit of nearly all popular brands of knob and lever-type cylindrical locksets, making them an ideal application for office doors, storage and file rooms, or residential doors: virtually any door where cylindrical hardware is used.



### Medeco XT Arrow Cylinders

Description	Part Number	Price
Medeco XT cylinder for all Arrow RK & MK series knobs and GL series levers. For RK & MK series, replace original spacer with Medeco CP-160321 (included)	20200A1 G	\$278.70

### Medeco XT Cylinders for Cal-Royal

Description	Part Number	Price
Cylinder for Cal-Royal Apollo series SL00 knob lock and LX01 lever lock	2020049 G	\$277.00
Cylinder for Cal-Royal CLS03 classroom function Gr. 2 lever lock	20200V1 G	\$277.00

### Medeco XT Cylinders for Corbin Russwin

Description	Part Number	Price
Cylinder for Corbin 800 lever lockset CL3300, CL3400, CL3500 & CL3600	2020073 G	\$277.00
Cylinder for Corbin Russwin CL3900 series leversets	20200V9 G	\$277.00

### Medeco XT Cylinders for Falcon

Description	Part Number	Price
Cylinder for Falcon B, LY, X, S & T series. Includes: CT-V03, CT-Y49, CT-Y54, CT-Y58, CTY68, CT-Y71, CT-Y72, CP-160311	20200F1 G	\$278.70
Cylinder for Falcon F521, F561, F581, and N series knobs	2020051 G	\$277.00
Cylinder for Falcon T-381 (inside)	2020073 G	\$277.00
Cylinder for Falcon T & RU series, T381 (exterior)	20200V3 G	\$277.00

### Medeco XT Cylinders for KABA-Mas-Hamilton

Description	Part Number	Price
Cylinder for Kaba E-plex 5000	2020000 G	\$277.00
Cylinder for Mas-Hamilton Power Lever	20200V1 G	\$277.00

### Medeco XT Cylinders for LSDA

Description	Part Number	Price
LSDA cylinder package fits 100, L100, LH1000, LX1000, Includes: CT-Y49, CT-Y70, CT-Y73, CTY78	20200L1 G	\$278.70

### Medeco XT Cylinder for Marks

Description	Part Number	Price
Cylinder for Marks 110, 170, 180, 190, 195, 295 series Vestibule, Communicating, Classroom, & Classroom Security functions (DA, DC, SB, S).	20200V0 G	\$277.00
Cylinder for Marks Lever 110, 170, 180, 190, 195, 295 series in Entrance, Institution, Storeroom, and Corridor functions (AB, DW, F, T)	20200V1 G	\$277.00

### Medeco XT Cylinders for Olympus

Description	Part Number	Price
Cylinder for Olympus 700 LCM & 800 LCM Key Retaining	20200S1 G	\$278.70

### Medeco XT Cylinders for PDQ

Description	Part Number	Price
Cylinder for PDQ Lever SP & ST Series, GT, XGT, & GP Series	20200V2 G	\$277.00

### Medeco XT Cylinders for Sargent

Description	Part Number	Price
Cylinder for Sargent 10 line locksets, order with '30' option prefix (note: cylinder will extend from lever more than standard cylinder)	20200S1 G	\$278.70

### Medeco XT Cylinders for Schlage

Description	Part Number	Price
Cylinder Package for Schlage A, AL, C, D, ND & Olympiad lever designs, includes: CT-Y49 (A, AL, & D Olympiad Lever & C & D Plymouth), CT-Y52 (C & D heavy duty knobs Ball, Globe & Sphere designs only), CT-Y53 (A series Orbit), CT-Y73 (ND series Gr. 1 lever & AL thick doors), and CTY74 (45-101 padlock)	20200S1 G	\$278.70
Cylinder for Schlage S Series Lever	2020097 G	\$278.70

### Medeco XT Cylinders for TACO

Description	Part Number	Price
Cylinder for Olympus 700 LCM & 800 LCM Key Retaining	20200S1 G	\$278.70

### Medeco XT Cylinders for Yale

Description	Part Number	Price
Cylinder for Yale 6 pin 5300LN, 5400LN and 4300 Knobs	200503 G	\$277.00

## Padlocks

The Medeco® XT electronic padlock cylinders are ideal for loss & liability management at off site or hard to reach locations. This robust cylinder securely operates in challenging environments with stainless steel components, and is designed for interior and exterior use. Keys are electronically programmed to open only specific locks during a designated schedule and audit information is recorded in both the lock and key. With no wiring or power supply required, these padlocks are an ideal application for perimeter fences and gates, or access to equipment storage areas where traditional EAC is practically impossible to install.



### Medeco XT Padlocks

Description	Part Number	Price
Medeco XT Hockey Puck Padlock	5293000 G	\$366.00
Indoor/Outdoor Padlock, Non-Key Retaining, 1 1/8" Shackle Clearance, 5/16" Shackle Diameter, With Cylinder	5451500 G	\$352.00
Indoor/Outdoor Padlock, Key Retaining, 1 1/8" Shackle Clearance, 5/16" Shackle Diameter, With Cylinder	54515R0 G	\$352.00
Indoor/Outdoor Padlock, Non-Key Retaining, 2 3/8" Shackle Clearance, 5/16" Shackle Diameter, With Cylinder	5451F00 G	\$355.00
Indoor/Outdoor Padlock, Key Retaining, 2 3/8" Shackle Clearance, 5/16" Shackle Diameter, With Cylinder	5451FR0 G	\$355.00
Shrouded Padlock, Non-Key Retaining, 3/4" Shackle Clearance, 5/16" Shackle Diameter, With Cylinder	5452500 G	\$372.00
Shrouded Padlock, Key Retaining, 3/4" Shackle Clearance, 5/16" Shackle Diameter, With Cylinder	54525R0 G	\$372.00
Indoor/Outdoor Padlock, Non-Key Retaining, 1 3/8" Shackle Clearance, 7/16" Shackle Diameter, With Cylinder	5471500 G	\$377.00
Indoor/Outdoor Padlock, Key Retaining, 1 3/8" Shackle Clearance, 7/16" Shackle Diameter, With Cylinder	54715R0 G	\$377.00
Indoor/Outdoor Padlock, Non-Key Retaining, 1 7/8" Shackle Clearance, 7/16" Shackle Diameter, With Cylinder	5471F00 G	\$380.00
Indoor/Outdoor Padlock, Key Retaining, 1 7/8" Shackle Clearance, 7/16" Shackle Diameter, With Cylinder	5471FR0 G	\$380.00
Shrouded Padlock, Non-Key Retaining, 3/4" Shackle Clearance, 7/16" Shackle Diameter, With Cylinder	5472500 G	\$409.00
Shrouded Padlock, Key Retaining, 3/4" Shackle Clearance, 7/16" Shackle Diameter, With Cylinder	54725R0 G	\$409.00
Medeco XT Protector II Large Body Padlock 7/16" shackle	5004732 G	\$438.60
Medeco XT Protector II Medium Body Padlock 5/16" shackle	5004734 G	\$416.00

### Medeco XT Padlock Cylinders

Description	Part Number	Price
Medeco XT System Series Padlock, Cylinder Only	510600 G	\$289.40
Medeco G8R Padlock, Pop-Out Cylinder Only – Round Deadbolt	EV-8501D	\$273.00
Medeco G8R Padlock, Pop-Out Cylinder Only – Round Springbolt	EV-8501S	\$273.00

## Cam and Utility Locks

Medeco® XT cam locks are built for strong physical security and offer all the benefits of the Medeco XT Electronic Locking System. Medeco XT cam locks are available in lengths of 7/8" and 1-1/8" with a wide variety of cams and security collars. The cylinder is designed for interior and exterior use and requires no wiring or modification to the door. Audit information recorded in both the lock and key shows a time-and-date stamped record of every event, including authorized accesses and unauthorized attempts. A quick retrofit to existing hardware – all in one convenient package. An excellent application for utility cabinets, retail fixtures, narcotics storage, safes and more.



### Cam Locks

Description	Part Number	Price
7/8" Cam lock assembly, Key Retaining	EN-150002-XXX (Op Code)	\$273.00
1 1/8" Cam lock assembly, Key Retaining	EN-150003-XXX (Op Code)	\$273.00

### Cam Lock Operation Codes

Description	Op Code
2 flat, 1 keypull, clockwise 90 degree	219
2 flat, 1 keypull, counter-clockwise 90 degree	239
2 flat, 1 keypull, clockwise 180 degrees	259

### Medeco XT T-bolt Cylinders

Description	Part Number	Price
Medeco XT T-bolt – Key Retaining, unlocked at 180 degree	6280550 G -XX	\$276.00
Medeco XT T-bolt – Non-Key Retaining, unlocked at 360 degree	6282550 G -XX	\$276.00

### Medeco XT Cam Lock

Description	Part Number	Price
1 1/8" Cam lock assembly, Non-Key Retaining	600650269 G -XX	\$276.40

### Medeco XT Switch Locks

Description	Part Number	Price
2 Position, Key Retaining	6522560 G -121-XX	\$265.90
2 Position, Non-Key Retaining	6522560 G -122-XX	\$265.90

## Retail/Showcase Locks

Medeco® XT has an electronic cylinder for many types of retail applications. Ideal for loss & liability management with flexible authorization and auditing capabilities. Respond quickly to security threats, lost or stolen keys, or personnel changes without the added cost of changing your locks and keys. The cylinder is powered by the rechargeable key so no wiring or power supply is needed. Medeco XT Plunger Locks are specifically designed for use in wooden or metal sliding doors. Cabinet style locks are also available and along with the plunger locks are ideal applications for security merchandise showcases, metal cabinets, and laboratory and office furniture.



### Medeco XT Retail/Showcase Locks

Description	Part Number	Price
Cabinet Lock, Latchbolt	490359 G	\$370.00
Cabinet Lock, Deadbolt	490366 G	\$370.00
XT Deadbolt Cabinet Lock, KR	6210555 G XX	\$297.00
XT Deadbolt Cabinet Lock, NKR	6212555 G XX	\$297.00
XT Spring Latch Cabinet Lock	6211555 G XX	\$310.00
XT T Bolt Cam Lock, KR	6280550 G	\$276.00
XT T Bolt Cam Lock, NKR	6282550 G	\$276.00



## International Cylinders

The Medeco® XT Modular Half Profile, Euro Double & Thumb Turn electronic cylinders are a direct replacement for like mechanical cylinders and are ideal for loss and liability management. In addition to international uses, many of these cylinders fit imported hardware used in North America. The cylinder requires no wiring or modification to the door or frame and is designed for interior and exterior use. Attack-resistant design and tamper-proof features provide strong protection against forced entry. Flexible key programming and auditing capabilities allow for quick response to security threats, lost or stolen keys, or personnel changes. Cylinders are widely used at government installations, airports, hotels, universities and schools. Medeco XT is a complete electronic locking system providing controlled access, accountability, physical security, and system management.



### Medeco XT International Cylinders

Description	Part Number	Price
Lockwood Oval	230301S G	\$253.00
Cylinder Module EURO 1/2 Module - 30mm	232201S 300 G	\$220.00
Cylinder Module EURO 1/2 Module - 35mm	232201S 301 G	\$224.00
Cylinder Module EURO 1/2 Module - 40mm	232201S 302 G	\$228.00
Single/Double cylinder Module EURO 1/2 Module - 30mm	232202S 300 G	\$224.00
Single/Double cylinder Module EURO 1/2 Module - 35mm	232202S 301 G	\$224.00
Single/Double cylinder Module EURO 1/2 Module - 40mm	232202S 302 G	\$228.00
Euro T/T Profile - 30mm/30mm Assembled	23230XS X00 G	\$291.00
Euro T/T Profile - 35mm/35mm Assembled	23230XS X11 G	\$299.00
Modular Profile Cylinder - 30mm Half Profile - Assembled	232301S 800 G	\$262.00
Modular Profile Cylinder - 35mm Half Profile - Assembled	232301S 801 G	\$266.00
Euro 1/2 Profile 30mm Assembled (True 30mm)	232301ST 800 G	\$262.00
Euro Double Profile - 30mm/30mm Assembled	23230E5 X00 G	\$344.00
Euro Double Profile - 35mm/35mm Assembled	23230E5 X11 G	\$352.00

## Specialty Cylinder Formats

The Medeco® XT Electronic T-handle Cylinders are an ideal for loss and liability management in a pop out cylinder application. The cylinder requires no wiring to the door and is powered by the Medeco XT rechargeable key. The cylinder is designed for interior and exterior use and has both key authorization/scheduling and auditing capabilities to track time and user accesses. More than just a way to protect your property, equipment and assets, Medeco XT is also a business tool that can lead to a substantial return on investment. Cylinders are available in spring-latch and deadbolt configurations. Stainless steel shell and bolt for lasting strength, durability and strong protection against physical attack. Fits all NAMA Standard T-Handles. Ideal for vending & bottling, bill changers, ATM equipment or other custom OEM applications.



### Pop-Out Cylinders

Description	Part Number	Price
Pop-Out Cylinder Deadbolt assembly, round bolt	EV-8501D	\$273.00
Pop-Out Cylinder, springbolt assembly, round bolt	EV-8501S	\$273.00

## Keys and Accessories

The Medeco® XT Key is a convenient, robust electronic key with a heavy duty stainless steel housing that fits right on your key ring. A portable key charger and rechargeable battery assures keys are always fully charged for up to 1,800 openings, eliminating the need for battery maintenance. Convenient key programming and flexible system management eliminates the need for removal of cylinder in order to make changes. This key holds operating and expiration schedule and flexible memory allocation lets the user decide how the memory is used; Access: up to 16,000 cylinders. Audit: up to 14,000 events. With Medeco XT, flexible authorization, auditing of use and quick retrofit to existing hardware are all available in one convenient package.



### Medeco XT Keys

Description	Part Number	Price
Medeco XT Industrial Key (G2)	EA-100107	\$139.00
Medeco XT Slim Line Key Basic (G2)	EA-100156	\$106.00
Medeco XT Slim Line Key Plus (G3S)	EA-100178	\$128.00
Medeco XT Slim Line Key Bluetooth (G3B)	EA-100177	\$161.00
Slim Line Demo/Install Key (G2)	EA-100173	\$204.00
Slim Line Demo/Install Control Key (G2)	EA-100174	\$204.00

### Medeco® XT Key Bundle

Description	Part Number	Price
Medeco XT Industrial Key (G2) & Charger Bundle. Includes Medeco XT Industrial Key, portable charger & USB cable	94-0239	\$197.00
Medeco XT Slim Line Key (G2) & Charger Bundle. Includes XT Slim Line Key, Charger and USB Cable	94-0271	\$173.00
Medeco XT Slim Line Key (G3S) Charger Bundle. Includes XT Slim Line Key, Charger and USB Cable	94-0307	\$195.00
Medeco XT Slim Line Key (G3B) & Charger Bundle. Includes XT Slim Line Key, Charger and USB Cable	94-0306	\$217.00

	Industrial (Gen 2)	Slim Line (Gen 2)	Slim Line S (Gen 3)	Slim Line B (Gen 3)
<b>Description</b>	Original with expanded memory	Redesigned to be smaller, lighter, increased LED visibility	Faster processor, faster communication, support for future functionality	Bluetooth version. Faster processor, faster communication, support for future functionality
<b>Part Number</b>	EA-100107	EA-100156	EA-100178	EA-100177
<b>Size</b>	3.1" x 1.25" x .65"	2.65" x 1.25" x .55"	2.65" x 1.25" x .55"	2.65" x 1.25" x .55"
<b>Weight</b>	2.38 oz	1.25 oz.	1.25 oz.	1.25 oz.
<b>Openings per charge</b>	1500-1800	1500-1800	1500-1800	1500-1800
<b>Durability</b>	Very High	High	High	High
<b>Memory</b>	16,000 cylinders	16,000 cylinders	14,000 cylinders	14,000 cylinders
<b>Audit</b>	10,000 events	10,000 events	14,000 events	14,000 events
<b>Battery Level Indicator</b>	High/Low	High/Low	Percentage	Percentage
<b>Warranty</b>	2 years	2 years	2 years	2 years



Multi-Key Charger



XT Mobile



XT Desktop



XT Remote Wall

**Medeco XT Programmers**

Description	Part Number	Price
Medeco XT Desktop USB Programming Station (order cable separately)	EA-100109	\$261.00
Medeco XT Mobile Programmer	EA-100125	\$778.00
Medeco XT Remote Wall Programmer - Program and update Medeco XT Keys remotely via an internet connection to the Medeco XT Web Manager	EA-100158	\$4,216.00
Medeco XT Remote Wall Programmer Wall Mount Kit	94-0294	\$58.80
Medeco XT Remote Wall Programmer Desktop Mount Kit	94-0295	\$107.00
Cam Lock and 90° bracket for XT Remote Programmer – Mounts to the side of the Remote Programmer and allows user to test key function after remote programming.	94-0296	\$275.00

**Medeco® XT Kits & Accessories**

Description	Part Number	Price
Medeco XT Portable Key Charging Adapter only (order cable separately)	EA-100088	\$54.30
Medeco XT Multi-Key Charger - Charge up to 10 Medeco XT Keys simultaneously (does not program keys)	EA-100138	\$596.00
Medeco XT USB System Dongle	EA-250050	\$76.60
Enhanced dongle for XT Solo and XT Web Self-Hosted	EA-250059	\$76.60
Medeco XT Key Wall Charger Kit	94-0291	\$105.00
Medeco XT Key Vehicle Charger Kit	94-0292	\$104.00
Medeco XT Key PC Kit (USB Cable and Charging Adapter)	94-0290	\$79.40
Smart SFIC Solutions Demo Kit (Includes Arrow, Medeco X4, and Medeco XT SFIC cylinders, keys, charger and cable)	940261	\$1,304.00
Medeco XT Try Me Demo Industrial Keys & SFIC with charger and USB cable - NOT PROGRAMMABLE	940264	\$843.00

**Medeco® XT Maintenance and Protective Products**

Description	Part Number	Price
Fluid Film, 2.25 oz	PK-KYLUBE-02	\$17.30
Fluid Film, 11.75 oz	PK-KYLUBE-11	\$27.60
Small Bristle Brush (non-metallic bristles) for cleaning cylinder & key contacts	CP-286180	\$26.30
Deoxit Contact Cleaning Pen (gold contact cleaner)	CP-301290	\$62.80
Metal cylinder protector cover	CP-287260	\$79.40
Plastic cylinder protector cover	CP-170930	\$58.80

**Self-Hosted Software - End User Startup Checklist:**

Description	Quantity	Part Number	Price
XT Programming Device	1	EA-100109	\$261.00
USB Cable	1	EA-200058	\$25.20
Enhanced USB System Dongle	1	EA-250059	\$76.60

**Web Hosted Service - End User Startup Checklist:**

Description	Quantity	Part Number	Price
XT Programming Device	1	EA-100109	\$261.00
USB Cable	1	EA-200058	\$25.20

**Professional Services**

Planning, design and support are crucial to the successful deployment of an Intelligent Key System. Medeco offers professional services to ensure every installation is planned and executed seamlessly, and the system works effectively to meet current and future needs to protect the investment. See page 18 for details and pricing.

# Medeco M<sup>3</sup> & X4 CLIQ<sup>®</sup>

Medeco M<sup>3</sup> and X4 CLIQ merge the features of electronics with reliable mechanical technology – all in a retrofit cylinder. M<sup>3</sup> and X4 CLIQ offer end users audit trail, user access schedules and the ability to quickly and remotely change intelligent key authorizations with the CLIQ Web Remote or CLIQ Connect App.

M<sup>3</sup> and X4 CLIQ installs with no wiring in a matter of minutes. Intelligent keys and digital cylinders reprogram wirelessly for electronic master keying. CLIQ can be combined with systems featuring Medeco<sup>3</sup>, X4 or BiLevel mechanical products to offer a blended security solution.

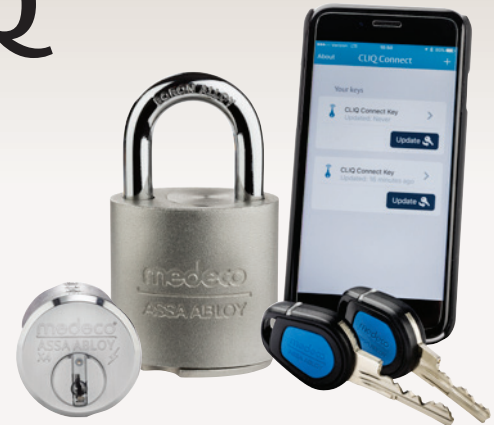

## Audit Accountability

Audit information recorded in both the lock and key shows a time-and-date stamped record of every event, including authorized accesses and unauthorized attempts.



## Uses Existing Hardware

The CLIQ intelligent key provides all power to the cylinder, eliminating the need for any hard wiring or power supply. Simply remove the existing mechanical cylinder and install the M<sup>3</sup> or X4 CLIQ cylinder. CLIQ can be keyed in with Medeco mechanical systems featuring Medeco<sup>3</sup> or BiLevel, Original or X4 (not available in SFIC).



## Reduces Risk of Lost Keys

Respond quickly to security threats, lost or stolen keys, or personnel changes utilizing expiring intelligent key validation intervals and remote programming.



## Electronic Scheduling

Intelligent keys are programmed for specific openings with fully flexible scheduling. Access profiles can be created where programming updates are generated automatically when an opening is added or removed.

## Technical Information:

- **Audits:** Key capacity – 1,000 events  
Cylinder capacity – 750 events
- **Management:** CLIQ Web Manager with Medeco Hosted or Self-Hosted License
- **Power:** Power supplied by the key, no hard wiring required
- **Weather Resistant:** Can be used in indoor or outdoor applications.  
– Rated for -20°F to 122°F (cylinder)
- **Security:** Encrypted identification in cylinder and Intelligent key
- **Formats:** Available in all common cylinder formats including KIK/KIL, LFIC, padlocks and deadbolts

## Key Features:

- Mechanical and electronic technology are combined for superior security with Medeco patented key control
- Audit key that stores up to 1,000 audit records provides information unavailable in a mechanical system
- Powered by an easily replaceable coin cell battery with 20,000 cycle battery life
- Available with RFID/PROX coil insert for dual use with HID compatible systems
- Visible and audible status feedback
- Compact size in water resistant housing
- Bluetooth enabled option with iOS and Android App support.

## Warranty:

Medeco<sup>®</sup> warrants the M<sup>3</sup> & X4 CLIQ products to be free of defects in material and/or workmanship for a period of two (2) years from date of original purchase

## Finishes:

- Available in several finish options

## CLIQ Web Manager Features:

- Role based system administration
- Access Profiles
- Remote Programming
- Web Services Integration
- Key Revalidation
- Automated Change Notification

## Cylinder Technologies:

- X4 CLIQ Technology code = “M”
- M<sup>3</sup> CLIQ Technology code = “S”
- Biaxial CLIQ Technology code = “V”
- Original CLIQ Technology code = “Z”

# Medeco M<sup>3</sup> & X4 CLIQ<sup>®</sup>

## Rim and Mortise Cylinders

A simple replacement of rim or mortise cylinders with M<sup>3</sup> or X4 CLIQ provides audit and scheduling along with expiration of credentials for any existing opening utilizing mortise hardware. Cylinders are available in all popular lengths and in any existing mechanical keyway. They are an ideal upgrade for offices requiring loss and liability control or as override for traditional EAC equipment.



### Medeco M<sup>3</sup> & X4 CLIQ Mortise Cylinders

Priced as Pinned. Master Key Up-charge of \$32.00 applies.

Description	Part Number	Price	M <sup>3</sup>	X4
1 1/8" Mortise Cylinder	100200	\$653.00	•	•
1 1/4" Mortise Cylinder	100500	\$654.00	•	•
1 3/8" Mortise Cylinder	105100	\$654.00	•	
1 1/2" Mortise Cylinder	105200	\$683.00	•	
1 3/4" Mortise Cylinder	105400	\$747.00	•	

### Medeco M<sup>3</sup> & X4 CLIQ Rim Cylinders

Description	Part Number	Price	M <sup>3</sup>	X4
Rim Cylinder, Horizontal Tailpiece	100400H	\$654.00	•	•
Rim Cylinder, Vertical Tailpiece	100400V	\$654.00	•	•
Rim Cylinder, Lazy Motion	100700	\$654.00	•	
Rim Cylinder, Sargent Mounting Style, Horizontal Tailpiece	100403H	\$654.00	•	
Rim Cylinder, Sargent Mounting Style, Vertical Tailpiece	100403V	\$654.00	•	

## Key-In-Knob/Lever Cylinders

M<sup>3</sup> & X4 CLIQ merges the flexibility of electronics with reliable mechanical technology – all in a key in knob or key in lever retrofit cylinder. Offers user audit trail, user access schedules and the ability to quickly add or remove a key electronically from a system, allowing quick response to security threats or lost/stolen keys. These cylinders fit nearly all popular brands and styles of hardware and are therefore an ideal application for offices, storage and file rooms, as well as any door where cylindrical hardware is used.



### Medeco M<sup>3</sup> & X4 CLIQ Cylinders for Arrow

Description	Part Number	Price	M <sup>3</sup>	X4
Cylinder Package for Arrow RK & MK Series Knobs & GL Series levers. Includes CT-Y70, CTY73, & CP-160321. Original cylinder spacer must be replaced with Medeco cylinder spacer CP-160321	20200A1	\$675.70	•	•
6 Pin cylinder for Arrow D & E single cylinder deadbolts; and Revolution V2 Deadbolts. * Order CT-Y27 tailpiece separately.	200901	\$675.00	•	
6 Pin cylinder for Arrow D & E double cylinder deadbolts	200902	\$675.00	•	

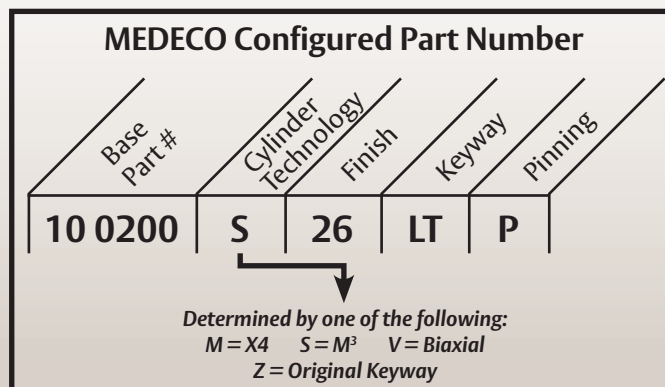

Cylinder Technologies are represented by the following letters:  
 S = M<sup>3</sup> CLIQ, M = X4 CLIQ, V = Medeco Biaxial CLIQ, Z = Medeco Original CLIQ



**Medeco M<sup>3</sup> & X4 CLIQ Cylinders for Alarm Lock***Priced as Pinned. Master Key Up-charge of \$32.00 applies.*

Description	Part Number	Price	M <sup>3</sup>	X4
Cylinder for Alarm Lock Trilogy T1, T2, T3	20200V1	\$674.00	•	•

**Medeco M<sup>3</sup> & X4 CLIQ Cylinders for Cal-Royal**

Description	Part Number	Price	M <sup>3</sup>	X4
Cylinder for Cal-Royal SL00 knob lock and LX01 lever lock	2020049	\$674.00	•	•
Cylinder for Cal-Royal CLS03 Classroom function Grade 2 lever lock	20200V1	\$674.00	•	•

**Medeco M<sup>3</sup> & X4 CLIQ Cylinders for Corbin Russwin**

Description	Part Number	Price	M <sup>3</sup>	X4
Cylinder for Corbin Russwin CL3900	20200V9	\$674.00	•	
Cylinder for Corbin Russwin CL3300, CL3400, CL3500, & CL3600	2021173	\$674.00	•	•

**Medeco M<sup>3</sup> & X4 CLIQ Cylinders for Dorma**

Description	Part Number	Price	M <sup>3</sup>	X4
Cylinder for Dorma CL853, CL860 (exterior), CL880, CL882, CL80EL, CL80EU Grade 1 lever, CK853, CK860 (exterior), CK880, CK882, CK80EL, & CK80EU Grade 1 knobs	20200V1	\$674.00	•	•
Cylinder for Dorma CL860 (interior), CL870, CL872, CL873, CL877 Grade 1 Lever, CK860 (interior), CK870, CK872, CK873 & CK 877 Grade 1 Knobs	20200V0	\$674.00	•	•
Cylinder for Dorma CL700 Series	2020049	\$674.00	•	•

**Medeco M<sup>3</sup> & X4 CLIQ Cylinders for Embassy**

Description	Part Number	Price	M <sup>3</sup>	X4
Cylinder for Embassy in Entrance, Institution, Storeroom, Corridor Functions. For Embassy Levers sold thru 9/06 and ALL Knobs	20200V1	\$674.00	•	•
Cylinder for Embassy Vestibule, Communicating, Classroom & Classroom Security Functions. For Embassy Levers sold thru 9/06 & ALL Knobs	20200V0	\$674.00	•	•

**Medeco M<sup>3</sup> & X4 CLIQ Cylinders for Falcon**

Description	Part Number	Price	M <sup>3</sup>	X4
Cylinder for Falcon B Series	2020049	\$674.00	•	•
Cylinder for Falcon B (CT-Y49), LY (CT-Y72), X (CT-Y68, except H knob or CT-Y71 - H knob), S (CT-Y54 - except H knob, or CT-Y58 - H knob) & F521, F561, F581, and N Series Knobs (CT-Y49 horizontal)	20200F1	\$675.70	•	•
Cylinder for Falcon Inside Cylinder T-381	2020073	\$674.00	•	•
Cylinder for Falcon T & RU Series, T381 Outside Cylinder	20200V3	\$674.00		•

**Medeco M<sup>3</sup> & X4 CLIQ Cylinders for KABA Mas Hamilton**

Description	Part Number	Price	M <sup>3</sup>	X4
Cylinder for Kaba E-plex 5000	2020000	\$674.00	•	•
Cylinder for Mas-Hamilton Power Lever	20200V1	\$674.00	•	•

**Medeco M<sup>3</sup> & X4 CLIQ Cylinders for LSDA**

Description	Part Number	Price	M <sup>3</sup>	X4
LSDA Cylinder package fits 100, , L100, LH1000, LX1000 Series. Includes: CT-Y49, CT-Y70, CTY73, CT-Y78	20200L1	\$675.70	•	

Cylinder Technologies are represented by the following letters:  
 S = M<sup>3</sup> CLIQ, M = X4 CLIQ, V = Medeco Biaxial CLIQ, Z = Medeco Original CLIQ



**Medeco M<sup>3</sup> & X4 CLIQ Cylinders for Marks**

*Priced as Pinned. Master Key Up-charge of \$32.00 applies.*

Description	Part Number	Price	M <sup>3</sup>	X4
Cylinder for Marks 110, 170, 180, 190, 195, 295 Series DA-Vestibule, DC & SB Communicating, S-Classroom & Classroom Security functions	20200V0	\$674.00	•	•
Cylinder for Marks Lever 110, 170, 180, 190, 195 & 295 Series in AB-Entrance, DWInstitution, F-Storeroom, & T-Corridor Functions	20200V1	\$674.00	•	•

**Medeco M<sup>3</sup> & X4 CLIQ Cylinder for Olympus**

Description	Part Number	Price	M <sup>3</sup>	X4
Cylinder for Olympus 700LCM & 800 LCM Key Retaining	20200S1	\$675.70	•	•
6 Pin Cylinder for Olympus 700LCM & 800LCM Non-Key retaining	20009S4	\$678.50	•	

**Medeco M<sup>3</sup> & X4 CLIQ Cylinders for PDQ**

Description	Part Number	Price	M <sup>3</sup>	X4
Cylinder for PDQ Lever SP & ST Series, GT, XGT, & GP Series	20200V2	\$674.00	•	

**Medeco M<sup>3</sup> & X4 CLIQ Cylinder for Sargent**

Description	Part Number	Price	M <sup>3</sup>	X4
Cylinder for Sargent 6, 7 and 10 Line KIK Series	2080147	\$675.00	•	•
Cylinder for Sargent 11 Line KIK Series	2080148	\$675.00	•	

**Medeco M<sup>3</sup> & X4 CLIQ Cylinders for Schlage**

Description	Part Number	Price	M <sup>3</sup>	X4
Cylinder Package for Schlage A, AL, C, D, ND & Olympiad lever designs, includes: CT-Y49 (A, AL, & D Olympiad Lever & C & D Plymouth), CT-Y52 (C & D heavy duty knobs Ball, Globe & Sphere designs only), CT-Y53 (A series Orbit), CT-Y73 (ND series Gr. 1 lever & AL thick doors), and CTY74 (45-101 padlock)	20200S1	\$675.70	•	•
Cylinder for Schlage S Series Lever	2020097	\$675.70	•	
Cylinder for Schlage B, E & F160 Series	20009S4	\$678.50	•	

**Medeco M<sup>3</sup> & X4 CLIQ Cylinders for Yale**

Description	Part Number	Price	M <sup>3</sup>	X4
6 pin cylinder for Yale 5300LN, 5400LN and 4300 Series	200503	\$674.00	•	•

**Medeco M<sup>3</sup> & X4 CLIQ Cylinders for TACO**

Description	Part Number	Price	M <sup>3</sup>	X4
Cylinder for TACO LXV Lever Lockset	2020078	\$674.00	•	

**Interchangeable Core Cylinders**

Medeco Large Format Interchangeable Core (LFIC) cylinders are designed so that cores can quickly and easily be changed by non-technical personnel using a special control key. Locks can, in effect, be “rekeyed” without having a working knowledge of the lock or having to take the lock apart. Medeco M<sup>3</sup> & X4 CLIQ format additionally provides the benefits of audit and scheduling features. LFIC cylinders fit many of the industry standard formats making them appropriate for almost any door/hardware application.



**Medeco M<sup>3</sup> & X4 CLIQ LFIC Cylinders**

Description	Part Number	Price	M <sup>3</sup>	X4
Cylinder for Medeco 6 pin LFIC	320201	\$679.00	•	
Cylinder for Yale 6 pin LFIC	310100	\$679.00	•	•
Cylinder for Yale 7 pin LFIC	310100A	\$679.00	•	•

Cylinder Technologies are represented by the following letters:  
 S = M<sup>3</sup> CLIQ, M = X4 CLIQ, V = Medeco Biaxial CLIQ, Z = Medeco Original CLIQ

## Deadbolts

In addition to the physical security of the Maxum deadbolt, the M<sup>3</sup> and X4 CLIQ cylinder provides an audit trail, the ability to schedule user access rights and the freedom to quickly add or remove a key from the system. The M<sup>3</sup> and X4 CLIQ deadbolt installs with no wiring in a matter of minutes and is available in existing mechanical keyways. Attack-resistant design and tamper-proof features provide strong protection against forced entry and allow for flawless integration into any home or business application.



\*All Medeco M<sup>3</sup> and X4 CLIQ Double Cylinder Deadbolts use Mechanical Cylinders on the inside of the deadbolt.

### Medeco M<sup>3</sup> & X4 CLIQ Deadbolt Cylinders

*Priced as Pinned. Master Key Up-charge of \$32.00 applies.*

Description	Part Number	Price	M <sup>3</sup>	X4
Cylinder for Arrow D, E & DB Series Single Cylinder Deadbolts	200901	\$723.00	•	
Cylinder for Sargent 470 & 480 single cylinder deadbolt	200901	\$723.00	•	
Cylinder for Sargent 470 & 480 double cylinder deadbolt	200902	\$723.00	•	
Lazy Motion Cylinder for Schlage B series (old style) deadbolt	200904	\$723.00	•	

### Medeco M<sup>3</sup> & X4 CLIQ Maxum Deadbolts - Commercial Trim

Description	Part Number	Price	M <sup>3</sup>	X4
• Single Cylinder Maxum Deadbolt, 1 1/8" Faceplate, 2 3/8" Backset	11C601	\$790.00	•	
• Single Cylinder Maxum Deadbolt, 1 1/8" Faceplate, 2 3/4" Backset	11C602	\$790.00	•	
• Single Cylinder Maxum Deadbolt, 1" Faceplate, 2 3/8" Backset	11C603	\$790.00	•	
• Single Cylinder Maxum Deadbolt, 1" Faceplate, 2 3/4" Backset	11C604	\$790.00	•	
• Single Cylinder Maxum Deadbolt, Drive In Front, 2 3/8" Backset	11C605	\$790.00	•	
• Single Cylinder Maxum, Drive In Front, 2 3/4" Backset	11C606	\$790.00	•	
• Single Cylinder Maxum Deadbolt, Less Bolt	11C60L	\$721.90	•	
Double Cylinder Maxum Deadbolt, 1 1/8" Faceplate, 2 3/8" Backset	11C621	\$878.00	•	
Double Cylinder Maxum Deadbolt, 1 1/8" Faceplate, 2 3/4" Backset	11C622	\$878.00	•	
Double Cylinder Maxum Deadbolt, 1" Faceplate, 2 3/8" Backset	11C623	\$878.00	•	
Double Cylinder Maxum Deadbolt, 1" Faceplate, 2 3/4" Backset	11C624	\$878.00	•	
Double Cylinder Maxum Deadbolt, Drive In Front, 2 3/8" Backset	11C625	\$878.00	•	
Double Cylinder Maxum, Drive In Front, 2 3/4" Backset	11C626	\$878.00	•	
Double Cylinder Maxum Deadbolt, Less Bolt	11C62L	\$809.90	•	

•Also Available in Classroom Function, 11C61X

### Medeco M<sup>3</sup> & X4 CLIQ Maxum Deadbolts - Residential Trim

Description	Part Number	Price	M <sup>3</sup>	X4
Single Cylinder Maxum Deadbolt, 1 1/8" Faceplate, 2 3/8" Backset	11R601	\$790.00	•	
Single Cylinder Maxum Deadbolt, 1 1/8" Faceplate, 2 3/4" Backset	11R602	\$790.00	•	
Single Cylinder Maxum Deadbolt, 1" Faceplate, 2 3/8" Backset	11R603	\$790.00	•	
Single Cylinder Maxum Deadbolt, 1" Faceplate, 2 3/4" Backset	11R604	\$790.00	•	
Single Cylinder Maxum Deadbolt, Drive In Front, 2 3/8" Backset	11R605	\$790.00	•	
Single Cylinder Maxum Deadbolt, Drive In Front, 2 3/4" Backset	11R606	\$790.00	•	
Single Cylinder Maxum Deadbolt, Less Bolt	11R60L	\$721.90	•	
Double Cylinder Maxum Deadbolt, 1 1/8" Faceplate, 2 3/8" Backset	11R621	\$878.00	•	
Double Cylinder Maxum Deadbolt, 1 1/8" Faceplate, 2 3/4" Backset	11R622	\$878.00	•	
Double Cylinder Maxum Deadbolt, 1" Faceplate, 2 3/8" Backset	11R623	\$878.00	•	
Double Cylinder Maxum Deadbolt, 1" Faceplate, 2 3/4" Backset	11R624	\$878.00	•	
Double Cylinder Maxum Deadbolt, Drive In Front, 2 3/8" Backset	11R625	\$878.00	•	
Double Cylinder Maxum Deadbolt, Drive In Front, 2 3/4" Backset	11R626	\$878.00	•	
Double Cylinder Maxum Deadbolt, Less Bolt	11R62L	\$809.90	•	

Cylinder Technologies are represented by the following letters:  
S = M<sup>3</sup> CLIQ, M = X4 CLIQ, V = Medeco Biaxial CLIQ, Z = Medeco Original CLIQ

## Padlocks

Medeco M<sup>3</sup> & X4 CLIQ padlocks are available to provide accountability in a weather resistant padlock that can be used in indoor or outdoor applications. Padlocks have robust reprogramming abilities, as well as audit and scheduling capabilities. Outstanding performance for your perimeter fences and gates, or access to equipment storage areas where traditional EAC is practically impossible to install.



Priced as Pinned. Master Key Up-charge of \$32.00 applies.

### Medeco M<sup>3</sup> & X4 CLIQ Padlock Cylinders

Description	Part Number	Price	M <sup>3</sup>	X4
Cylinder for Medeco Protector II (50) Series Padlock	500020	\$675.10	•	
Cylinder for Medeco System (54) Series Padlock	510600	\$737.40	•	•
Cylinder for Abus Padlock Series 83KNK/45, 83KNK/50 & 83KNK/55. (Use Abus driver M)	2020000	\$674.00	•	•
Cylinder for American 3600/3700 Padlock (Use American driver DR-MED6)	2020000	\$674.00	•	•
Cylinder for New Standard Padlock	2020052	\$674.00	•	
Cylinder for Master 20 and 6600, 6700 Pro Series (Use Master driver 0298-627)	2020000	\$674.00	•	•
Cylinder for Schlage 45-101 padlock	2020074	\$674.00	•	•

### Medeco M<sup>3</sup> & X4 CLIQ Protector II Padlocks (Includes Cylinder)

Description	Part Number	Price	M <sup>3</sup>	X4
Large Body - 7/16" dia shackle, 1 3/8" clearance	5004732	\$875.60	•	
Large Body - 7/16" dia shackle, 1 3/8" clearance, Dust cover	50047321	\$889.90	•	
Large Body - 7/16" dia shackle, 1 7/8" clearance	5004832	\$879.60	•	
Large Body - 7/16" dia shackle, 1 7/8" clearance, Dust cover	50048321	\$893.90	•	
Med Body - 5/16" dia shackle, 1 3/8" clearance	5004734	\$853.00	•	
Med Body - 5/16" dia shackle, 1 3/8" clearance, Dust cover	50047341	\$867.30	•	
Med Body - 5/16" dia shackle, 1 7/8" clearance	5004834	\$857.00	•	
Med Body - 5/16" dia shackle, 1 7/8" clearance, Dust cover	50048341	\$871.30	•	

### Medeco M<sup>3</sup> & X4 CLIQ System Series Padlocks (Includes Cylinder)

Description	Part Number	Price	M <sup>3</sup>	X4
<b>Padlock 5/16" Shackle - KIK</b>				
Indoor/Outdoor Padlock, 1 1/8" Shackle Clearance	54515X0	\$787.00	•	•
Indoor/Outdoor Padlock, 2 3/8" Shackle Clearance	5451FX0	\$790.00	•	•
Shrouded Padlock, 3/4" Shackle Clearance	54525X0	\$807.00	•	•
<b>Padlock 5/16" Shackle - 6 Pin LFIC</b>				
Indoor/Outdoor Padlock, 1 1/8" Shackle Clearance	54615X0	\$796.30	•	
Indoor/Outdoor Padlock, 2 3/8" Shackle Clearance	5461FX0	\$802.30	•	
Shrouded Padlock, 3/4" Shackle Clearance	54625X0	\$820.30	•	
<b>Padlock 7/16" Shackle - KIK</b>				
Indoor/Outdoor Padlock, 1 3/8" Shackle Clearance	54715X0	\$812.00	•	•
Indoor/Outdoor Padlock, 1 7/8" Shackle Clearance	5471FX0	\$815.00	•	•
Shrouded Padlock, 3/4" Shackle Clearance	54725X0	\$844.00	•	•
<b>Padlock 7/16" Shackle - 6 Pin LFIC</b>				
Indoor/Outdoor Padlock, 1 3/8" Shackle Clearance	54815X0	\$826.30	•	
Indoor/Outdoor Padlock, 1 7/8" Shackle Clearance	5481FX0	\$831.30	•	
Shrouded Padlock, 3/4" Shackle Clearance	54825X0	\$859.10	•	

\* 0 = Non-key retaining and R = key retaining

**Medeco M<sup>3</sup> CLIQ 50 Series Brass Body Padlock**

Priced as Pinned. Master Key Up-charge of \$32.00 applies.

Description	Part Number	Price	M <sup>3</sup>	X4
Brass Body CLIQ® Padlock, key retaining, hardened steel shackle, dust cover, less cylinder	50762011	\$156.00		
Brass Body CLIQ® Padlock, key retaining, stainless steel shackle, dust cover, less cylinder	50762111	\$156.00		
Brass Body CLIQ® Padlock, non-key retaining, hardened steel shackle, dust cover, less cylinder	50772011	\$156.00		
Brass Body CLIQ® Padlock, non-key retaining, stainless steel shackle, dust cover, less cylinder	50772111	\$156.00		
Brass Body CLIQ® Padlock, key retaining, hardened steel shackle, dust cover, case cover (rubber), less cylinder	50762014	\$175.10		
Brass Body CLIQ® Padlock, key retaining, stainless steel shackle, dust cover, case cover (rubber), less cylinder	50762114	\$175.10		
Brass Body CLIQ® Padlock, non-key retaining, hardened steel shackle, dust cover, case cover (rubber), less cylinder	50772014	\$175.10		
Brass Body CLIQ® Padlock, non-key retaining, stainless steel shackle, dust cover, case cover (rubber), less cylinder	50772114	\$175.10		
Chain assembly for CLIQ® 50 Series Brass Body Padlock	CP-280271	\$29.70		
Cylinder for CLIQ® 50 Series Padlock: Medeco 6 pin LFIC (M <sup>3</sup> technology)	320201	\$679.00	•	

**International Cylinders**

Medeco's international cylinders are designed to fit in locksets of major world manufacturers. In addition to international uses, many of these cylinders fit imported hardware used in North America. These M<sup>3</sup> CLIQ cylinders can be installed into standard hardware with no wiring or other modifications, as power is supplied by the key. Reprogramming, audit and key scheduling capabilities are available with easy to use software. Cylinders are widely used at high security government installations, industrial and institutional organizations, airports, hotels, power plants, palaces, museums, universities and schools, and office buildings.

**Medeco M<sup>3</sup> CLIQ International Cylinders**

Description	Part Number	Price	M <sup>3</sup>	X4
Cylinder Module Single/Double 36 mm	2322016 300 S	\$557.00	•	
Cylinder Module Single/Double 41mm	2322016 301 S	\$561.00	•	
Euro Single Assembled 36mm/36mm*	23230X6 X00 S	\$627.00	•	
Euro Double Assembled 36mm/36mm**	23230E6 X00 S	\$667.00	•	
Euro Half 0mm	2323016 800 S	\$627.00	•	
Euro Half 5mm Extended	2323016 801 S	\$631.00	•	

\* Standard sizes available from the factory.

\*\* Only one side is electronic, the other is mechanical.

Cylinder Technologies are represented by the following letters:  
S = M<sup>3</sup> CLIQ, M = X4 CLIQ, V = Medeco Biaxial CLIQ, Z = Medeco Original CLIQ

# Medeco CLIQ<sup>®</sup> CONNECT Key

## Bluetooth Low Energy Enabled Keys

Medeco M<sup>3</sup> and X4 CLIQ intelligent keys are now available with BLE connectivity. The CLIQ CONNECT Key offers CLIQ remote updates when paired with supported iOS and Android smartphones. The CLIQ CONNECT APP is available as a free download from either App Store and manages the CONNECT Key(s) pairing to the smartphone while reporting key battery level, marking, and system number. Keys are user friendly with visible and audible status feedback, compact in size with water resistant housing, and are powered by an easily replaceable CR2330 battery. Utility patented key control provides protection against unauthorized key duplication.

### Connect Key Features:

- Available with RFID/PROX coil
- Visible and audible status feedback
- Compact size in water resistant housing
- New key design, easy battery access
- Powered by an easily replaceable CR2330 coin cell battery, with up to one year battery life
- Available in M<sup>3</sup>, X4 and Original/Biaxial Keyways

### CONNECT App Features:

- Bluetooth (BLE) enabled with iOS & Android Apps
- Free App download from Apple or Play Stores
- Obtain remote updates via supported Apple and Android Smartphones
- Key audit report via CONNECT App
- Pair and manage multiple CONNECT keys



### Medeco M<sup>3</sup> & X4 CLIQ CONNECT Keys

Description	Part Number	Price
X4 CLIQ_Dynamic/E3 User Key	KEC 49XB03	\$157.00
M <sup>3</sup> CLIQ_Dynamic/E3 User Key	KEC 48XB03	\$157.00
Original/Biaxial CLIQ_Dynamic/E3 User Key	KEC 47XB03	\$157.00

Visit [www.cliqkey.tips](http://www.cliqkey.tips) for additional information

Cylinder Technologies are represented by the following letters:  
S = M<sup>3</sup> CLIQ, M = X4 CLIQ, V = Medeco Biaxial CLIQ, Z = Medeco Original CLIQ



# Medeco CLIQ® Go

## CLIQ Go keeps small businesses secure on the go

Medeco “CLIQ Go” is the newest addition to the CLIQ family of intelligent keys, cylinders and cloud-based software. A great way to introduce Intelligent Keying systems to small and mid-sized businesses, CLIQ Go was designed for the business which may need access control on only a handful of doors. It allows owners to manage their security on the go using the CLIQ Go mobile app on a cellphone or other mobile device.

CLIQ Go product is sold and managed by local locksmiths as a stocked item. Cylinders easily retrofit a business’ mechanical door hardware, so installation is quick and simple.



The locksmith programs the keys and provides the business owner with basic system training on CLIQ’s cloud-based software. Owners can then use the CLIQ Go app on a mobile phone or pad to quickly change an opening’s access rights, modify key schedules or disable a key on any opening.

Participating locksmiths are Medeco-trained to provide outstanding customer service and support with every CLIQ Go system they sell.

**For information on becoming a CLIQ Go Dealer, call Medeco Customer Care at 877-633-3261.**

### CLIQ Go Start-up Equipment

Description	Part Number	Price
CLIQ Go Reseller key (R-Key)	EA-100224	\$145.00
X4 CLIQ Desktop Reseller cylinder programmer	94-0312	\$345.00
CLIQ Go programming device for end user	EA-100222	\$440.00
CLIQ Connect Mobile Programming Device	EA-100230	\$820.00
CLIQ Express software license and CLIQ Go training (web based – up to 4 hours covering CLIQ Go hardware concepts and overview, CLIQ express software and CLIQ Go app)	SW-500121-0	\$1,200.00
CLIQ Go First Year Software Subscription for each end user Signed by Reseller. Billed to the Reseller Net.	SW-500121-1	\$200.00
CLIQ Go Annual Software Subscription Renewal for each end user signed by Reseller. Billed to the Reseller Net.	SW-500121-1R	\$200.00



# Medeco M<sup>3</sup> & X4 CLIQ<sup>®</sup>

## Keys and Accessories

Medeco M<sup>3</sup> and X4 CLIQ intelligent keys operate both CLIQ cylinders as well as compatible mechanical cylinders for unmatched system flexibility and security. Maintaining and ensuring system integrity by means of key audit to obtain historic user access information, as well as the ability to schedule access to doors, is an invaluable tool. M<sup>3</sup> and X4 CLIQ keys are also mechanically compatible with Medeco<sup>3</sup> and Medeco<sup>3</sup> Bilevel and Medeco X4 products with the potential to integrate into an already existing key system. Keys are user friendly with visible and audible status feedback, are compact in size with water resistant housing and are powered by an easily replaceable CR2330 battery. Utility patented key control provides protection against unauthorized key duplication.



Visit [www.cliqkey.tips](http://www.cliqkey.tips) for additional information

### Medeco M<sup>3</sup> & X4 CLIQ Cut Keys

Description	Part Number	Price
X4 CLIQ E2 Normal User Key	KEC 49X002	\$118.00
X4 CLIQ E3 Dynamic User Key	KEC 49X003	\$118.00
X4 CLIQ E2 Prox Normal User Key	KEC 49XP02	\$130.00
X4 CLIQ E3 Prox Dynamic User Key	KEC 49XP03	\$130.00
X4 CLIQ Yale LFIC Control Key*	KEC 49X013	\$118.00

\*Yale Control Key required if ordering 31 Series IC. Indicate "6" or "7" pin at first "X". Example: KEC496013

M <sup>3</sup> CLIQ E2 Normal User Key	KEC 48X002	\$118.00
M <sup>3</sup> CLIQ E3 Dynamic User Key	KEC 48X003	\$118.00
M <sup>3</sup> CLIQ E2 Normal Prox User Key	KEC 48XP02	\$130.00
M <sup>3</sup> CLIQ E3 Dynamic Prox User Key	KEC 48XP03	\$130.00
M <sup>3</sup> CLIQ LFIC Control	KEC 48X023	\$118.00
M <sup>3</sup> CLIQ Yale LFIC Control Key*	KEC 48X013	\$118.00

\*Yale Control Key required if ordering 31 Series IC. Indicate "6" or "7" pin at first "X". Example: KEC486013

Original/Biaxial CLIQ E2 Normal User Key	KEC 47X002	\$118.00
Original/Biaxial CLIQ E3 Dynamic User Key	KEC 47X003	\$118.00
Original/Biaxial CLIQ E2 Prox Normal User Key	KEC 47XP02	\$130.00
Original/Biaxial CLIQ E3 Prox Dynamic User Key	KEC 47XP03	\$130.00
Original/Biaxial CLIQ LFIC Control Key	KEC 47X023	\$118.00
Original/Biaxial CLIQ Yale LFIC Control Key*	KEC 47X013	\$118.00

\*Yale Control Key required if ordering 31 Series IC. Indicate "6" or "7" pin at first "X". Example: KEC476013

- Normal Key systems require Loading Authorizations On Lock via the system C-Key.
- Dynamic Key systems require Loading Authorizations On Key via a desktop or remote programming device.

Please consult with your Medeco eCylinder representative to determine which strategy is best for the desired application/installation.

C-Key for M <sup>3</sup> CLIQ	KEB 48600C	\$150.70
C-Key for Original or Biaxial CLIQ	KEB 47600C	\$150.70
C-Key X4 CLIQ	KEB 49600C	\$150.70
V -Prox Battery Cap Programmed - Black (25)	94-0304-MOP	\$504.00
V- Prox Battery Cap Programmed - Blue (25)	94-0304-MBP	\$504.00
V -Prox Battery Cap, No Programming - Black (25)	94-0305-MOP	\$420.00
V - Prox Battery Cap, No Programming - Blue (25)	94-0305-MBP	\$420.00
Prox Battery Cap, Programmed - Black	E A-500054-MOP	\$28.20
Prox Battery Cap, Programmed - Blue	EA-500054-MBP	\$28.20
CR2330 Replacement Battery (for use in M <sup>3</sup> and X4 CLIQ keys)	EA-350084	\$4.20

# Medeco M<sup>3</sup> & X4 CLIQ<sup>®</sup>

## Programming and Management

CLIQ<sup>®</sup> Web Manager is a robust and versatile software used by administrators to efficiently manage their CLIQ<sup>®</sup> System. The CLIQ<sup>®</sup> Web Manager Hosting Service is cloud-based, giving administrators the ability to manage their system from anywhere with internet access and have the benefit of the latest software enhancements. In addition, it offers secure 24/7 web access and no start-up fees, making it a cost-effective solution to meet a wide variety of needs. Choose the offering that best fits your CLIQ<sup>®</sup> system size and requirements.



## CLIQ<sup>®</sup> Web Hosting Service

Description	Part Number	Annual License Fee
<b>Basic:</b> Designed for smaller systems and includes desktop/local key and cylinder programming only, Domain Administration. Limit 750 keys.	SW-500101-1	\$72100
<b>Remote Plus:</b> Designed for mid-sized systems and includes Basic features plus remote, mobile and BLE programming, key revalidation, cylinder groups, access profiles, temporary access groups. Limit 750 keys.	SW-500101-3	\$2,266.00
<b>Enterprise:</b> Designed for large systems and includes all Remote Plus features plus web services for 3rd party applications. Limit 1500 keys.	SW-500101-5	\$3,708.00
<b>Enterprise Plus:</b> Designed for systems larger than 1500 keys. Options available for purchase include custom server configuration, AWS GovCloud web hosting.		Call for pricing
<i>These offerings are billed annually.</i>		

## CLIQ<sup>®</sup> Self-Hosted Software

Description	Part Number	One-time License Fee	Annual Maintenance Fee
Enterprise Self-Hosted One-Time Fee. Includes all Remote Plus features plus web services for 3rd party applications.	SW-600801	\$36,050.00	
Enterprise Self-Hosted Annual Recurring Maintenance Fee.	SW-600801-6R		\$5,408.00
<i>Maintenance fees are billed annually.</i>			
Self-hosted software purchases entitle the user to a single user license with no annual license fees. However, the software maintenance fee is recommended and provides regular software program updates, maintenance releases, patches, and technical telephone assistance.			

CLIQ Web Manager Client PC minimum requirements: Windows Vista, Windows 7, Windows 8 (64 bit), Pro/Enterprise/Ultimate (32 or 64 bit), Windows 10, Internet Explorer 10.0 or higher or Firefox 16.0.2 or higher. CLIQ Web Manager is a licensed product for both Medeco Hosted Services and End-User Self Hosted Software.

### Medeco M<sup>3</sup> & X4 CLIQ Programming Devices

Description	Part Number	Price
M <sup>3</sup> CLIQ Local Programming Device (Includes USB Cable)	EA-100168	\$509.00
M <sup>3</sup> CLIQ Remote Wall PD	EA-100126	\$837.00
M <sup>3</sup> CLIQ Mobile Programmer	EA-100142	\$796.00
M <sup>3</sup> CLIQ Outdoor, Vandal Resistant, Wall Programmer	EA-100160	\$1,509.00
X4 CLIQ Local Programming Device (Includes USB Cable)	EA-100179	\$509.00
X4 CLIQ Remote Wall PD	EA-100180	\$837.00
X4 CLIQ Mobile Programmer	EA-100181	\$796.00
X4 CLIQ Outdoor, Vandal Resistant, Wall Programmer	EA-100182	\$1,509.00

### Medeco M<sup>3</sup> & X4 CLIQ Kits & Accessories

Description	Part Number	Price
Biaxial and M <sup>3</sup> Bottom Pin Kit for use with M <sup>3</sup> CLIQ (Original Product uses standard pin kit)	.KW5401	\$685.00
Metal Cylinder Protector Cover	CP-287260	\$79.40
Plastic cylinder protector cover	CP-170930	\$58.80

### End-User Startup Checklist:

- CLIQ Web Manager
- CLIQ Local Programmer
- CLIQ C Key
- Remote Wall and/or Mobile Programmers
- User Keys

### Professional Services

Planning, design and support are crucial to the successful deployment of an Intelligent Key System. Medeco offers professional services to ensure every installation is planned and executed seamlessly, and the system works effectively to meet current and future needs to protect the investment. See page 18 for details and pricing.

# Medeco Classic CLIQ®

Medeco Classic CLIQ merges the features of electronics with reliable mechanical technology – all in a retrofit cylinder. Medeco CLIQ offers end users audit trail, user access schedules and the ability to quickly and remotely change intelligent key authorizations with the CLIQ Web Manager and Remote.

Medeco Classic CLIQ installs with no wiring in a matter of minutes and intelligent keys and digital cylinder reprogram for electronic master keying.



## Audit Accountability

Audit information recorded in both the lock and key shows a time-and-date stamped record of every event, including authorized accesses and unauthorized attempts.



## Uses Existing Hardware

The Medeco CLIQ intelligent key provides all power to the cylinder, eliminating the need for any hard wiring or power supply. Simply remove the existing mechanical cylinder and install the Medeco Classic CLIQ cylinder.



## Reduces Risk of Lost Keys

Respond quickly to security threats, lost or stolen keys or personnel changes utilizing expiring intelligent key validation intervals and remote programming.



## Electronic Scheduling

Intelligent Keys are programmed for specific openings with fully flexible scheduling. Access profiles can be created where programming updates are generated automatically when an opening is added or removed.

## Technical Features:

- **Audits:** Key capacity – 1,000 events  
Cylinder capacity – 750 events
- **Management:** CLIQ Web Manager with Medeco Hosted or Self-Hosted License
- **Power:** Power supplied by the key, no hard wiring required
- **Lockcase:** Fits standard Rim & Mortise Housing as well as other various platforms
- **Weather Resistant:** Can be used in indoor or outdoor applications  
– Rated for -20° F to 122° F (cylinder)
- **Security:** Encrypted identification in cylinder & intelligent key
- **Formats:** Available in all common cylinder formats including KIK/KIL, LFIC, padlocks and deadbolts

## Key Information:

- Audit key holds up to 1,000 audit records and provides information unavailable in a mechanical system
- Self-cleaning electronic contact point for a long lasting key and reliable connection
- Powered by an easily replaceable CR2025 Battery with 20,000 cycle battery life
- Available with HID Prox coil insert for dual use with HID compatible EAC systems
- Visible status feedback
- Compact size in water resistant housing

## Warranty:

Medeco® warrants the Medeco Classic CLIQ products to be free of defects in material and/or workmanship for a period of two (2) years from date of original purchase

## Finishes:

- Available in several finish options

## CLIQ Web Manager Features:

- Role based system administration
- Access Profiles
- Remote Programming Web
- Services Integration
- Key Revalidation
- Automated Change Notification

## Cylinder Technologies:

- Classic CLIQ Technology code = “C”

# Medeco Classic CLIQ®

## Rim and Mortise Cylinders

A simple replacement of rim or mortise cylinders with classic CLIQ cylinders provides audit and scheduling along with expiration of credentials for any existing opening utilizing mortise hardware. Cylinders are available in all popular lengths and are an ideal upgrade for offices or as override for traditional EAC equipment.



### Medeco Classic CLIQ Mortise Cylinders

Description	Part Number	Price
1 1/4" Mortise Cylinder	100500 C	\$722.00
1 3/8" Mortise Cylinder	105100 C	\$721.00
1 1/2" Mortise Cylinder	105200 C	\$779.00
1 3/4" Mortise Cylinder	105400 C	\$850.00
2" Mortise Cylinder	105500 C	\$851.00
2 1/2" Mortise Cylinder	105700 C	\$851.00

*Medeco Classic CLIQ mortise cylinders are not available longer than 2 1/2"*

### Medeco Classic CLIQ Rim Cylinders

Description	Part Number	Price
Rim Cylinder - Horizontal Tailpiece	100400H C	\$722.00
Rim Cylinder - Vertical Tailpiece	100400V C	\$722.00
Rim Cylinder - Sargent Mounting Style, Horizontal Tailpiece	100403H C	\$722.00
Rim Cylinder - Sargent Mounting Style, Vertical Tailpiece	100403V C	\$722.00
Rim Cylinder - 180 Degree Lazy Motion	100700 C	\$722.00

## Key-In-Knob/Lever Cylinders

Medeco's Key-in-Knob cylinders are designed to retrofit knob type cylindrical locksets, lever type cylindrical locksets, padlocks and bored type auxiliary deadlatches and deadlocks. Medeco Classic CLIQ KIK/KIL cylinders additionally offer user audit trail, user access schedules and the ability to quickly add or remove a key electronically from a system, allowing fast response to security threats or lost/stolen keys. These cylinders fit nearly all popular brands and styles of hardware and are therefore an ideal application for office doors, storage and file rooms, or residential doors; virtually any door where cylindrical hardware is used.



### Medeco Classic CLIQ Cylinders for Alarm Lock

Description	Part Number	Price
Cylinder for Alarm Lock Trilogy T1, T2, T3	20200V1 C	\$722.00

*\*Due to possible variances in hardware tolerance and door preparation, Classic CLIQ KIK cylinders should be field tested in lever or knob applications where the key retracts the latch directly to ensure proper hardware operation.*

**Medeco Classic CLIQ Cylinders for Arrow**

Description	Part Number	Price
Cylinder Package for Arrow MK Series include CT-Y70, CT-Y73, CP-160321	20200A1 C	\$723.70
Cylinder for Arrow RK Series & MK Series (Except Ball), original cylinder spacer must be replaced with Medeco spacer CP-160321	2020070 C	\$722.00
Cylinder for Arrow MK Series (Ball knob only) and GL series	2020073 C	\$722.00
Cylinder for Arrow H & S Knob Series, L, ML, Q, & W Series Lever	2020249 C	\$722.00
Cylinder for Arrow JL Series Interconnected lock, deadbolt cylinder also necessary	2020249 C	\$722.00

**Medeco Classic CLIQ Cylinder for Cal-Royal**

Description	Part Number	Price
Cylinder for Cal-Royal SL00 Knob Lock and LX01 Lever Lock	2020049 C	\$722.00
Cylinder for Cal-Royal CLS03 Classroom Function Grade 2 Lever Lock	20200V1 C	\$722.00

**Medeco Classic CLIQ Cylinder for Corbin Russwin**

Description	Part Number	Price
Cylinder for Corbin Russwin CL3900	20200V9 C	\$722.00
Cylinder for Corbin Russwin 800, CL3300, CL3400, CL3500, CL3600	2021173 C	\$722.00
Cylinder for Corbin Russwin CK4200 (new style)	205005 C	\$722.00

**Medeco Classic CLIQ Cylinder for Dorma**

Description	Part Number	Price
Cylinder for Dorma® CL700 series	2020049 C	\$722.00
Cylinder for Dorma® CL860 (Interior), CL870, CL872, CL873, CL877 Grade 1 Lever, CK860 (Interior), CK870, CK872, CK873, & CK877 Grade 1 Knobs	20200V0 C	\$722.00
Cylinder for Dorma® CL853, CL860 (exterior), CL880, CL882, CL80EL, CL80EU Grade 1 Lever, CK853, CK860 (exterior), CK880, CK882, CK80EL, & CK80EU Grade 1 Knobs	20200V1 C	\$722.00

**Medeco Classic CLIQ Cylinder for Embassy**

Description	Part Number	Price
Cylinder for Embassy lockset in Entrance, Institution, Storeroom, Corridor functions.	20200V1 C	\$722.00

**Medeco Classic CLIQ Cylinder for Hager**

Description	Part Number	Price
Cylinder for Hager Lever Locksets, Model 3553,3570,3579,3580	2020249 C	\$722.00

**Medeco Classic CLIQ Cylinder for KABA - Mas-Hamilton**

Description	Part Number	Price
Kaba E-plex 5000	2020000 C	\$722.00
MAS-Hamilton Power Lever	20200V1 C	\$722.00

**Medeco Classic CLIQ Cylinder for LSDA**

Description	Part Number	Price
LSDA Cylinder Package Fits 100, L100, LH1000, LX1000 Series. Includes: CT-Y49, CT-Y70 (for 100 Series Knob, except B and L100 Series Lever), CT-Y73 (for 100 Series B knob), CT-Y78 (for LX1000 Lever)	20200L1 C	\$723.70

*\*Due to possible variances in hardware tolerance and door preparation, Classic CLIQ KIK cylinders should be field tested in lever or knob applications where the key retracts the latch directly to ensure proper hardware operation.*



**Medeco Classic CLIQ Cylinder for Marks**

Description	Part Number	Price
Cylinder for Marks 110, 170, 180, 190, 195, 295 series Vestibule, Communicating, Classroom, & Classroom Security functions (DA, DC, SB, S).	20200V0 C	\$722.00
Cylinder for Marks Lever 110, 170, 180, 190, 195, 295 series in Entrance, Institution, Storeroom, and Corridor functions (AB, DW, F, T)	20200V1 C	\$722.00

**Medeco Classic CLIQ Cylinder for Olympus**

Description	Part Number	Price
Cylinder for Olympus 700 LCM and 800 LCM Key Retaining cabinet lock, includes: CTY49, CT-Y52, CT-Y53, CT-Y54	20200S1 C	\$723.70

**Medeco Classic CLIQ Cylinder for PDQ**

Description	Part Number	Price
Cylinder for PDQ Lever SP & ST series, GT, XGT & GP Series	20200V2 C	\$722.00

**Medeco Classic CLIQ Cylinder for Sargent**

Description	Part Number	Price
Cylinder for Sargent 10 line locksets order with '30' option prefix (note: cylinder will extend from lever more than standard cylinder)	20200S1 C	\$723.70

**Medeco Classic CLIQ Cylinders for Schlage**

Description	Part Number	Price
Cylinder Package for Schlage A, AL, C, D, ND & Olympiad lever designs, includes: CT-Y49 (A, AL, & D Olympiad Lever & C & D Plymouth), CT-Y52 (C & D heavy duty knobs Ball, Globe & Sphere designs only), CT-Y53 (A series Orbit), CT-Y73 (ND series Gr. 1 lever & AL thick doors), and CTY74 (45-101 padlock)	20200S1 C	\$723.70
Cylinder for Schlage D Series Lever, Athen, Rhodes, & Sparta designs	2020249 C	\$722.00

**Medeco Classic CLIQ Cylinder for TACO**

Description	Part Number	Price
Cylinder for TACO LXV lever lockset	2020078 C	\$722.00

**Medeco Classic CLIQ Cylinder for Yale**

Description	Part Number	Price
Cylinder for Yale 6 pin 5300LN, 5400LN and 4300 Knobs	200503 C	\$722.00

*\*Due to possible variances in hardware tolerance and door preparation, Classic CLIQ KIK cylinders should be field tested in lever or knob applications where the key retracts the latch directly to ensure proper hardware operation.*

# Medeco Classic CLIQ®

## Interchangeable Core Cylinders

Medeco Classic CLIQ LFIC cores offer end users the ability to obtain an audit trail, schedule user access rights and quickly and easily remove a key electronically from a system. This cylinder installs into standard Schlage-style LFIC housing hardware with no wiring or other modifications. It is drill and tamper resistant, and ideal for indoor or outdoor installations. Common applications include business entrances such as banks and shopping centers, as well as many school and university applications.



## Medeco Classic CLIQ Cylinders for Schlage

Description	Part Number	Price
Classic CLIQ cylinder for Schlage style LFIC	322201 C	\$727.00

## Padlocks

Medeco Classic CLIQ retrofit cylinders are available for the Medeco System Series and G8R padlocks, as well as several other popular brands such as American, Schlage or Master. These locks are weather resistant and can be used in indoor or outdoor applications. Padlocks have simple reprogramming abilities, as well as audit and scheduling capabilities for perimeter fences and gates, or for equipment storage areas where traditional EAC is practically impossible to install.



## Medeco Classic CLIQ Padlock Cylinders

Description	Part Number	Price
Medeco System Series padlock cylinder (padlock body sold separately)	510600 C	\$789.40
G8R Padlock popout cylinder, deadbolt function (padlock body sold separately)	641201 C	\$734.25
G8R Padlock popout cylinder, springbolt function (padlock body sold separately)	641200 C	\$734.25
Cylinder for American 3600/3700 padlock (Use American driver DR-MED6)	2020000 C	\$722.00
Cylinder for New Standard padlocks	2020052 C	\$722.00
Cylinder for Master 20 and 6600, 6700 Pro Series (Use Master driver 0298-627 for Pro Series)	2020000 C	\$722.00
Cylinder for Schlage 45-101 padlock	2020074 C	\$722.00
Cylinder for Abus Padlock Series 83KNK/45, 83KNK/50 & 83KNK/55. (Use Abus driver M)	2020000 C	\$722.00

## Medeco Classic CLIQ Padlock Options

Refer to the Padlock Section for System Series and G8R Padlock part numbers and options.

# Medeco Classic CLIQ®

## Deadbolts

The Medeco Classic CLIQ Maxum deadbolt provides a loss and liability solution in Medeco's Maxum deadbolt platform. In addition to the physical security of the Maxum deadbolt, the Medeco Classic CLIQ cylinder provides an audit trail, the ability to schedule user access rights and the freedom to quickly add or remove a key from the system. The Medeco Classic CLIQ deadbolt installs in a matter of minutes without cumbersome wiring. Attack-resistant design and tamper-proof features provide strong protection against forced entry and allow for flawless integration into any home or business application.



## Medeco Classic CLIQ Deadbolt Cylinders

Description	Part Number	Price
Cylinder for Arrow D, E & DB Series Single Cylinder Deadbolts	200901 C	\$723.00
Cylinder for Arrow Revolution deadbolt	200901 C	\$723.00
Cylinder for Sargent 470 & 480 single cylinder deadbolt	200901 C	\$723.00
Cylinder for Sargent 470 & 480 double cylinder deadbolt	200902 C	\$723.00
Lazy Motion Cylinder for Schlage B series (old style) deadbolt	200904 C	\$723.00

## Medeco Classic CLIQ Maxum Deadbolts - Commercial Trim

Description	Part Number	Price
• Single Cylinder Maxum Deadbolt, 1 1/8" Faceplate, 2 3/8" Backset	11C601 C	\$846.00
• Single Cylinder Maxum Deadbolt, 1 1/8" Faceplate, 2 3/4" Backset	11C602 C	\$846.00
• Single Cylinder Maxum Deadbolt, 1" Faceplate, 2 3/8" Backset	11C603 C	\$846.00
• Single Cylinder Maxum Deadbolt, 1" Faceplate, 2 3/4" Backset	11C604 C	\$846.00
• Single Cylinder Maxum Deadbolt, Drive In Front, 2 3/8" Backset	11C605 C	\$846.00
• Single Cylinder Maxum, Drive In Front, 2 3/4" Backset	11C606 C	\$846.00
• Single Cylinder Maxum Deadbolt, Less Bolt	11C60L C	\$777.90

• Available Classroom Function, 11C61X C.

## Medeco Classic CLIQ Maxum Deadbolts - Residential Trim

Description	Part Number	Price
Single Cylinder Maxum Deadbolt, 1 1/8" Faceplate, 2 3/8" Backset	11R601 C	\$846.00
Single Cylinder Maxum Deadbolt, 1 1/8" Faceplate, 2 3/4" Backset	11R602 C	\$846.00
Single Cylinder Maxum Deadbolt, 1" Faceplate, 2 3/8" Backset	11R603 C	\$846.00
Single Cylinder Maxum Deadbolt, 1" Faceplate, 2 3/4" Backset	11R604 C	\$846.00
Single Cylinder Maxum Deadbolt, Drive In Front, 2 3/8" Backset	11R605 C	\$846.00
Single Cylinder Maxum Deadbolt, Drive In Front, 2 3/4" Backset	11R606 C	\$846.00
Single Cylinder Maxum Deadbolt, Less Bolt	11R60L C	\$777.90

# Medeco Classic CLIQ®

## Cam and Utility Locks

Medeco® Classic CLIQ cam locks are recognized throughout the world as the standard for protection. Medeco offers a complete line of various cam lock sizes and functions to meet your specific needs. In addition to providing the ultimate defense against drilling, pulling, and other forms of vandal attacks, locks have both electronic auditing and scheduling capabilities that offer further security in many applications. Storage cabinets, vending machines, lockers and tool boxes can all be accommodated without any wiring and be utilized in either indoor or outdoor use.



### Medeco Classic CLIQ Cam Locks

Description	Part Number	Price
7/8" Cam lock	60810 XXX C	\$735.25
7/8" Cam lock with hardened plug face	60810D XXX C	\$798.25
1 1/8" Cam lock	60820 XXX C	\$735.25
1 1/8" Cam lock with hardened steel plug face	60820D XXX C	\$798.25

### Medeco Classic CLIQ Cam Lock Codes

Description	Op Code
1 Flat, 1 Key Pull, Clockwise 90 degree	119
2 Flat, 1 Key Pull, Clockwise 90 degree	219
2 Flat, 2 Key Pull, Clockwise 90 degree	229
2 Flat, 1 Key Pull, Counterclockwise 90 degree	239
2 Flat, 2 Key Pull, Counterclockwise 90 degree	249
2 Flat, 1 Key Pull, Clockwise 180 degree	259
2 Flat, 2 Key Pull, Clockwise 180 degree	269

## Retail/Showcase Cylinders

Medeco Classic CLIQ showcase and cabinet locks offer end users audit trail, user access schedules and the ability to quickly add or remove a key electronically from a system. Installs with no wiring in a matter of minutes, and electronic keys and cylinders reprogram for instant changes. With ease of tracking capabilities, in a retail environment these locks are ideal to protect against both customer and employee theft, and to allow efficient access for sales associates with full audit accountability. Available to fit many types of display cases, as well as cash drawers and inventory cabinets.



### Medeco Classic CLIQ Cabinet Locks

Description	Part Number	Price
Plunger Lock, Round Bolt	490358 C	\$864.00
Plunger Lock, T- Bolt	490368 C	\$864.00
Cabinet Lock, Latchbolt	490359 C	\$829.00
Cabinet Lock, Deadbolt	490366 C	\$829.00
Showcase Ratchet Lock	490361 C	\$796.20

# Medeco Classic CLIQ®

## International Cylinders

Medeco’s international cylinders are designed to fit in locksets of major world manufacturers. In addition to international uses, many of these cylinders fit imported hardware used in North America. These Medeco Classic CLIQ cylinders can be installed into standard hardware with no wiring or other modifications, as power is supplied by the key. Reprogramming, audit and key scheduling capabilities are available with easy to use software. These cylinders are widely used at high security government installations, industrial and institutional organizations, airports, hotels, power plants, palaces, museums, universities and schools, and office buildings.

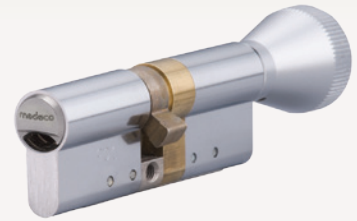

### Medeco Classic CLIQ International Cylinders

Description	Part Number	Price
Thumbturn Profile - Assembled 30/30mm	2325005 C	\$902.00
Double Cylinder Profile - Assembled 30/30mm	2325025 C	\$1,290.00

- Other lengths available, please inquire.

## Vending Cylinder Formats

Medeco Classic CLIQ specialty cylinders offer industrial or route management vendors electronic control over their assets. Medeco Classic CLIQ offers end users audit trail, user access schedules and the ability to quickly add or remove a key electronically from a system. Installs with no wiring in a matter of minutes and electronic keys and cylinders reprogram for instant changes. Audit information recorded in both the lock and key shows a time-and-date stamped record of every event, including authorized accesses and unauthorized attempts. Medeco Classic CLIQ products add a wide variety of intelligent features without compromising on physical security. Attack-resistant design and tamper-proof features provide strong protection against forced entry.



### Medeco Classic CLIQ Pop-Out Cylinders

Description	Part Number	Price
CLIQ Pop-out Cylinder, Springbolt	641200 C	\$734.25
CLIQ Pop-out, Springbolt, Hardened Plug	641200D C	\$797.25
CLIQ Pop-out Cylinder, Deadbolt	641201 C	\$734.25
CLIQ Pop-Out Cylinder, Deadbolt, Hardened Plug	641201D C	\$797.25

# Medeco Classic CLIQ®

## Keys and Accessories

Medeco Classic CLIQ intelligent keys operate Classic CLIQ cylinders for system flexibility and security they maintain and ensures system integrity by means of key audit to obtain historic user access information, as well as the ability to schedule access to doors. Keys are user friendly with visible LCD status feedback, compact in size with water resistant housing and are powered by an easily replaceable CR2025 battery.



## Medeco Classic CLIQ Keys

Description	Part Number	Price
E2/Normal User Key - Key Only	KEC 42602B	\$131.40
E3/Dynamic User Key - Key Only	KEC 42603B	\$131.40
C-Key	KEC 4260CR	\$166.10
E2/Normal User Key with 125kHz PROX Cover	KEC 426P2B	\$143.40
E3/Dynamic User Key with 125kHz PROX Cover	KEC 426P3B	\$143.40
CLIQ Battery Cover w/Proximity-upgrade standard Medeco Classic CLIQ keys to RFID Proximity Keys (sold in pack of 25) - Black only	94-0249	\$366.00

- Normal Key systems require Loading Authorizations On Lock via the system C-Key.
  - Dynamic Key systems require Loading Authorizations On Key via a desktop or remote programming device.
- Please consult with your Medeco eCylinder representative to determine which strategy is best for the desired application/installation.*

## Medeco Classic CLIQ Programming Devices

Description	Part Number	Price
Medeco Classic CLIQ Local Programming Device (Includes USB Cable)	EA-100167	\$509.00
Remote Wall PD for Medeco Classic CLIQ	EA-100121	\$872.00
Medeco Classic CLIQ Mobile Programmer	EA-100145	\$796.00
Outdoor, Vandal Resistant, Wall Programmer for Medeco Classic CLIQ keys	EA-100159	\$1,509.00

## Medeco Classic CLIQ Kits & Accessories

Description	Part Number	Price
Plastic Cylinder Protection Cover	CP-170930	\$58.80
Metal Cylinder Protection Cover	CP-287260	\$79.40

## End-User Startup Checklist:

- CLIQ Web Manager
- CLIQ Local Programmer
- CLIQ C Key
- Remote Wall and/or Mobile Programmers
- User Keys

## Professional Services

Planning, design and support are crucial to the successful deployment of an Intelligent Key System. Medeco offers professional services to ensure every installation is planned and executed seamlessly, and the system works effectively to meet current and future needs to protect the investment. See page 18 for details and pricing.



# Medeco Classic CLIQ®

## Programming and Management

CLIQ® Web Manager is a robust and versatile software used by administrators to efficiently manage their CLIQ® System. The CLIQ® Web Manager Hosting Service is cloud-based, giving administrators the ability to manage their system from anywhere with internet access and have the benefit of the latest software enhancements. In addition, it offers secure 24/7 web access and no start-up fees, making it a cost-effective solution to meet a wide variety of needs. Choose the offering that best fits your CLIQ® system size and requirements.



### CLIQ® Web Hosting Service

Description	Part Number	Annual License Fee
<b>Basic:</b> Designed for smaller systems and includes desktop/local key and cylinder programming only, Domain Administration. Limit 750 keys.	SW-500101-1	\$721.00
<b>Remote Plus:</b> Designed for mid-sized systems and includes Basic features plus remote, mobile and BLE programming, key revalidation, cylinder groups, access profiles, temporary access groups. Limit 750 keys.	SW-500101-3	\$2,266.00
<b>Enterprise:</b> Designed for large systems and includes all Remote Plus features plus web services for 3rd party applications. Limit 1500 keys.	SW-500101-5	\$3,708.00
<b>Enterprise Plus:</b> Designed for systems larger than 1500 keys. Options include custom server configuration, FedRAMP compliance.		Call for pricing
<i>These offerings are billed annually.</i>		

### CLIQ® Self-Hosted Software

Description	Part Number	One-time License Fee	Annual Maintenance Fee
Enterprise Self-Hosted One-Time Fee. Includes all Remote Plus features plus web services for 3rd party applications.	SW-600801	\$36,050.00	
Enterprise Self-Hosted Annual Recurring Maintenance Fee.	SW-600801-6R		\$5,408.00
<i>Maintenance fees are billed annually.</i>			
Self-hosted software purchases entitle the user to a single user license with no annual license fees. However, the software maintenance fee is recommended and provides regular software program updates, maintenance releases, patches, and technical telephone assistance.			

CLIQ Web Manager Client PC minimum requirements: Windows Vista, Windows 7, Windows 8 (64 bit), Pro/Enterprise/Ultimate (32 or 64 bit), Windows 10, Internet Explorer 10.0 or higher or Firefox 16.0.2 or higher. CLIQ Web Manager is a licensed product for both Medeco Hosted Services and End-User Self Hosted Software.

# Medeco<sup>3</sup>

## High Security Cylinders & Locking Systems

Medeco<sup>3</sup> High Security Cylinders feature UL437 Listed physical strength components like the triple locking technology for ultimate pick resistance and solid brass construction with strategically placed hardened inserts to thwart drilling attacks.

Passing UL437 and BHMA's rigid testing procedures reaffirms Medeco<sup>3</sup>'s ability to protect people and property. Medeco<sup>3</sup> builds on Medeco's over 40 years of lock engineering innovation and takes security to the next level while still offering the highest level of protection against unauthorized key duplication.



### Patented Key Control

Protects against unauthorized duplication of your keys.



### Uses Existing Hardware

Can be master keyed into a system containing Medeco BiLevel and Medeco<sup>3</sup> mechanical as well as M<sup>3</sup> CLIQ eCylinders. Medeco<sup>3</sup> cylinders are available in a wide variety of formats, retrofitting most hardware on the market today.



### Can Be Master Keyed

Can be master keyed into a system containing Medeco BiLevel and Medeco<sup>3</sup> mechanical as well as M<sup>3</sup> CLIQ eCylinders.



### Protection From Physical Attack

Medeco<sup>3</sup> cylinders are UL 437 Listed and stand up to drilling, picking and other forms of physical attack.



### Special Angle Cut Keys

Requires a special key cutting machine and access to Medeco specific blanks, available in a variety of restrictions to support every need.



### Picking and Bumping Protection

Medeco<sup>3</sup> cylinders use a sidebar that prevent the key from rotating until it is elevated, rotated and aligned in the correct position. This feature protects against bumping and picking attacks.

## Technical Information:

- 40,000 cycle endurance test
- Resistance to picking or key fitting tests
- **UL437:**
  - Tests prescribed in Underwriters Laboratory Standard for Safety for Key Locks are primarily designed to measure a locking cylinder's ability to resist physical attack.
- **ANSI/BHMA A156.30:**
  - Builders Hardware Manufacturing Association (BHMA) standards are certified by the American National Standards Institute (ANSI) which works with industry leaders to provide manufacturers and consumers with product quality and performance ratings based on preset criteria and standardized testing.
  - BHMA standard A156.30-2003, approved and adopted by ANSI, covers high security cylinders and was developed by BHMA to provide specific guidance as to which products can be considered as high security cylinders.
  - Medeco<sup>3</sup> cylinders have been tested to BHMA's highest certification level by an independent laboratory and achieved certification in the high security cylinders category.
  - The cylinders meet or exceed BHMA A156.30 criteria for strength and durability, key control, and surreptitious entry resistance.

## Applications:

- Medeco<sup>3</sup> retrofit cylinders are ideal for any application requiring key control and physical security of your cylinders

## Warranty:

Medeco<sup>3</sup> cylinders are warranted for two years against manufacturer's defects. See the Medeco® limited warranty for full details

# Medeco BiLevel

BiLevel cylinders offer affordable key control through patent protected keys. Standard locking systems without utility patent protected keys allow anyone who gains possession of a key to easily and inexpensively make a copy. With an unauthorized duplicate key, a thief has complete access to a building, its physical and intellectual property, and the people inside. BiLevel locking systems ensure that the keys to a facility can only be duplicated by certified Medeco dealers and only with the proper authorization.

Medeco® BiLevel cylinders can tie in with other Medeco® mechanical and eCylinder products for master keying purposes.



### Patented Key Control

Protects against unauthorized duplication of your keys.



### Uses Existing Hardware

Medeco offers the largest selection of retrofit cylinders that reduce cost by eliminating the need to replace your existing hardware.



### Can Be Master Keyed

Can be master keyed into a system containing Medeco BiLevel and Medeco<sup>3</sup> mechanical as well as M<sup>3</sup> CLIQ eCylinders.



### Special Angle Cut Keys

Requires a special key cutting machine and access to Medeco specific blanks, available in a variety of restrictions to support every need.



### Picking and Bumping Protection

Medeco<sup>3</sup> cylinders use a sidebar that prevent the key from rotating until it is elevated, rotated and aligned in the correct position. This feature protects against bumping and picking attacks.

### Technical Information:

- Can be keyed with Medeco<sup>3</sup> and M<sup>3</sup> CLIQ products

### Applications:

The Medeco BiLevel retrofit cylinders are ideal for any application patented key control where physical high security is not necessary

### Warranty:

Medeco BiLevel cylinders are warranted for two years against manufacturer's defects. See the Medeco limited warranty for full details

### Cylinder Formats:

- Rim & Mortise
- Key in Knob/Lever Cylinders
- Large Format Interchangeable Cores
- Padlocks

# Medeco X4

All facilities need patented key control to effectively secure exterior and interior openings. This strength of integrity allows security managers to have peace of mind when it comes to managing the system. Unfortunately, instituting a new key system is not always easy... or economical.

Medeco X4 is an economic and efficient solution to rekeying needs. Medeco X4 has one of the largest master key capabilities on the market, allowing facility managers to tie everything together under one key for ease, convenience and efficiency. Additionally, Medeco X4 easily retrofits into existing systems, significantly reducing installation time.

Medeco X4 is the perfect security upgrade for small format interchangeable core (SFIC) installations. In addition to SFIC cylinders, Medeco X4 is also available in many other styles of retrofit cylinders that can all be keyed into a single system.



#### Patented Key Control

Protects against unauthorized duplication of your keys.



#### Uses Existing Hardware

Medeco X4 is available in a large selection of retrofit cylinder formats that can all be keyed into a single system.



#### Quickly Change Cores

Medeco X4 SFIC cylinder provides quick and easy cylinder changes in the event keys are lost or stolen.



#### Can be Master Keyed

Available in Small Format Interchangeable Cores (SFIC) and other retrofit cylinder formats which can be master keyed together, eliminating the need to replace your existing hardware.

#### Technical Information:

- Superior master key capabilities, up to four (4) times that of similar style cylinders
- One key flexibility for different cylinder styles compatible
- Patented key control lasting until the year 2030
- Custom key coining for added security

#### Applications:

The Medeco X4 retrofit cylinders are ideal for any application requiring key control and physical security of your cylinders

#### Warranty:

Medeco X4 cylinders are warranted for two years against manufacturer's defects. See the Medeco® limited warranty for full details

#### Cylinder Formats:

- Rim & Mortise
- Key in Knob/Lever Cylinders
- Small Format Interchangeable Cores
- Large Format Interchangeable Cores
- Padlocks

# Medeco<sup>B</sup>

Medeco<sup>B</sup> Small Format Interchangeable Cores (SFIC) provide quick and easy cylinder changes in the event keys are lost or stolen. Medeco<sup>B</sup> is an economic and efficient solution to rekeying needs. Medeco<sup>B</sup> easily retrofits into existing systems, significantly reducing installation time.

Medeco<sup>B</sup> offers flexibility and is available in standard 6 and 7 pin format in established competitive keyways. The reinforced sleeve design provides added strength and durability.



### Competitive Keyways

Medeco<sup>B</sup> is an affordable alternative for end users currently using industry standard unpatented keyways. Available keyways: 1C, 1D, AB, BB, CB, DB, EB, FB, GB, HB, JB, KB, LB, MB, QB, RB, TA, TB, TC, TD, TE, WA, WB, WC, WG, WH & WY.



### Quickly Change Cores

Medeco<sup>B</sup> SFIC cylinder provides quick and easy cylinder changes in the event keys are lost or stolen.



### Fits Existing & New Master Key Systems

Medeco<sup>B</sup> is priced to save clients' money vs. other unpatented competitors and can be substituted directly into existing SFIC master key systems.

### Applications:

The Medeco<sup>B</sup> retrofit cylinders are ideal for any application requiring unpatented key control that can be substituted directly into existing master key systems.

### Warranty:

Medeco<sup>B</sup> cylinders are warranted for two years against manufacturer's defects. See the Medeco<sup>®</sup> limited warranty for full details.

### Finishes:

- Available in all standard finishes to match existing hardware.

### Technical Information:

- Solid brass construction
- Reinforced sleeve design
- Uses A2 SFIC Specifications
- Plain face
- 6 & 7 pin unpatented SFIC
- Sleeve, shell, plug & face plate made of brass
- Keyway stamped on the back of the plug
- Individually capped pin chambers
- Available in the following industry standard SFIC keyways: 1C, 1D, AB, BB, CB, DB, EB, FB, GB, HB, JB, KB, LB, MB, QB, RB, TA, TB, TC, TD, TE, WA, WB, WC, WG, WH & WY
- Dealers do not need a contract to purchase Medeco<sup>B</sup> SFIC Cores. Cores are available through Medeco and authorized distributors.

# Rim & Mortise Cylinders

FEATURES	Medeco <sup>3</sup>	BiLevel	Medeco X4	CLIQ	Medeco XT
Utility patented key control provides protection from unauthorized duplication of keys	●	●	●	●	●
UL437 Listing and BHMA Certification provide validation of high security from recognized, independent testing laboratories	●				
Triple locking principle provides pick resistance and large numbers of combinations for master keying flexibility to accommodate systems of virtually any size	●				
Hardened steel inserts in the cylinder face provide proven drill resistance	●				
Nickel plated pins provide exceptional wear resistance and additional hardened stainless steel pins provide drill resistance	●	●			
Solid nickel silver pins provide exceptional wear resistance			●		
Retrofits into virtually any manufacturers' locksets for cost effective improved security	●	●	●	●	●
High security and key control may be incorporated in a single system for cost effective system flexibility	●	●		●	
Keys may be integrated with Hybrid proximity head for greater system retrofit	●	●	●	●	

## Medeco<sup>3</sup> Premium High Security

For effective mechanical protection against most forms of attack as well as protection against unauthorized duplicate keys, Medeco<sup>3</sup> cylinders are recommended. Security features including hardened steel components, pins that must be elevated, rotated, and interact with both a sidebar and a slider, and additional pick resistant features make Medeco<sup>3</sup> the cylinder of choice to protect people, property and information.

## Medeco<sup>3</sup> BiLevel Patented Key Control

Medeco<sup>3</sup> BiLevel cylinders may be incorporated into a master key system with Medeco<sup>3</sup> high security, offering protection against all types of attack where needed, and patented key control cylinders for areas requiring less protection. BiLevel cylinders offer patented control against unauthorized duplication of keys without the additional security features protecting against force or surreptitious attack.

## Medeco X4 Patented Key Control

Medeco X4 cylinders offer patented control against unauthorized duplication of keys without the additional security features protecting against force or surreptitious attack.

## Intelligent Key Solutions

Many of the cylinders in this section are also available with an Intelligent Key solution. See the Intelligent Key section for more details.



# Rim & Mortise Cylinders

Medeco® Rim and Mortise cylinders provide patented key control and the Medeco<sup>3</sup> version provides UL437 Physical Security in adaptable retrofit cylinder formats. Medeco Mortise cylinders have threads on the outside of the shell and are designed to be screwed into other manufacturer's mortise lock cases. A cam on the back of the cylinder operates the lock mechanism and a set screw holds the mortise cylinder in place. Medeco Rim cylinders are used with auxiliary rim locks such as: surface mounted deadbolts, night latches, panic devices and jimmy proof locks (also known as vertical dropbolts or interlocking deadbolts). Rim cylinders are held in place with a back plate and two mounting screws. 10 series, rim and mortise cylinders, are UL437 Listed for drill and pick resistance, and the those that incorporate the Medeco<sup>3</sup>, BiLevel, or Medeco X4 design, offer utility patented key control.



## Patented Key Control

Protects against unauthorized duplication of your keys.



## Uses Existing Hardware

Medeco offers the largest selection of retrofit Rim & Mortise cylinders that reduce cost by eliminating the need to replace your existing hardware.



## Can Be Master Keyed

Medeco<sup>3</sup> and BiLevel Rim & Mortise cylinders can be master keyed into a system containing Medeco BiLevel and Medeco<sup>3</sup> mechanical as well as Medeco<sup>3</sup> CLIQ eCylinders.



## Protection From Physical Attack

Medeco<sup>3</sup> Rim & Mortise cylinders are UL 437 Listed and stand up to drilling, picking and other forms of physical attack.



## Special Angle Cut Keys

Requires a special key cutting machine and access to Medeco specific blanks, available in a variety of restrictions to support every need.



## Picking and Bumping Protection

Medeco<sup>3</sup> cylinders use a sidebar that prevent the key from rotating until it is elevated, rotated and aligned in the correct position. This feature protects against bumping and picking attacks.

## Applications

Flexible options designed to retrofit various manufacturers of mortise and rim locks

## Warranty:

Warranted for two (2) years against manufacturer's defects. See the Medeco® limited warranty for full details

## Technical Features:

- BHMA A156.30 Certification assures patent protected key control and physical strength
- BHMA A156.5 Grade 1 Certification assures consistent quality for heavy use applications
- Solid brass construction provides high quality and long cylinder life
- Set screw pin chamber caps allow quick and easy pinning and re-keying without the need to take the cylinder apart
- Large variety of cylinder lengths and cam/tailpiece configurations provide excellent retrofit capability and reduce the need to replace the entire locking device

## Finishes:

- Available in all standard finishes to match existing hardware

## Available Key Technologies:

### Mechanical:

- Medeco<sup>3</sup>
- Medeco<sup>3</sup> BiLevel
- Medeco X4

### eCylinder:

- M<sup>3</sup> CLIQ
- Classic CLIQ
- Medeco X4 CLIQ
- Medeco XT

## How To Order Rim & Mortise Cylinders

Complete part numbers are required for all orders. To determine the correct part number, fill in the "X's" in sequential order.

1	2	3	4	5															
<p><b>100200</b> base part #</p> <p>Refer to pages 65-68 for descriptions and technical specifications to find the corresponding base part number.</p>	<p><b>T</b> cylinder</p> <p>- = Original K = Medeco KM T = Medeco<sup>3</sup> W = Biaxial J = Medeco<sup>3</sup> BiLevel C = Classic CLIQ N = Medeco X4 S = M<sup>3</sup> CLIQ M = Medeco X4 CLIQ</p>	<p><b>05</b> finish</p> <p>Refer to the inside back cover of this catalog for finish options. Include the corresponding two digit finish number.</p> <p>Upcharge for split finish.</p>	<p><b>LT</b> keyway</p> <p>Insert keyway if known or contact Customer Service for help.</p>	<p><b>S</b> pinning</p> <table border="1"> <thead> <tr> <th>S =</th> <th>P =</th> <th>M =</th> </tr> </thead> <tbody> <tr> <td>Sub-Assembled (Uncombined)</td> <td>Pinned (Combined)</td> <td>Master Keyed</td> </tr> <tr> <td>No additional information needed</td> <td>Keyed alike (KA)</td> <td>Provide specific pinning or contact Customer Service for support</td> </tr> <tr> <td></td> <td>Keyed different (KD)</td> <td>Must specify quantity for keys.</td> </tr> <tr> <td></td> <td>2 keys per cylinder</td> <td></td> </tr> </tbody> </table>	S =	P =	M =	Sub-Assembled (Uncombined)	Pinned (Combined)	Master Keyed	No additional information needed	Keyed alike (KA)	Provide specific pinning or contact Customer Service for support		Keyed different (KD)	Must specify quantity for keys.		2 keys per cylinder	
S =	P =	M =																	
Sub-Assembled (Uncombined)	Pinned (Combined)	Master Keyed																	
No additional information needed	Keyed alike (KA)	Provide specific pinning or contact Customer Service for support																	
	Keyed different (KD)	Must specify quantity for keys.																	
	2 keys per cylinder																		

### BUILD A RIM & MORTISE PART #:

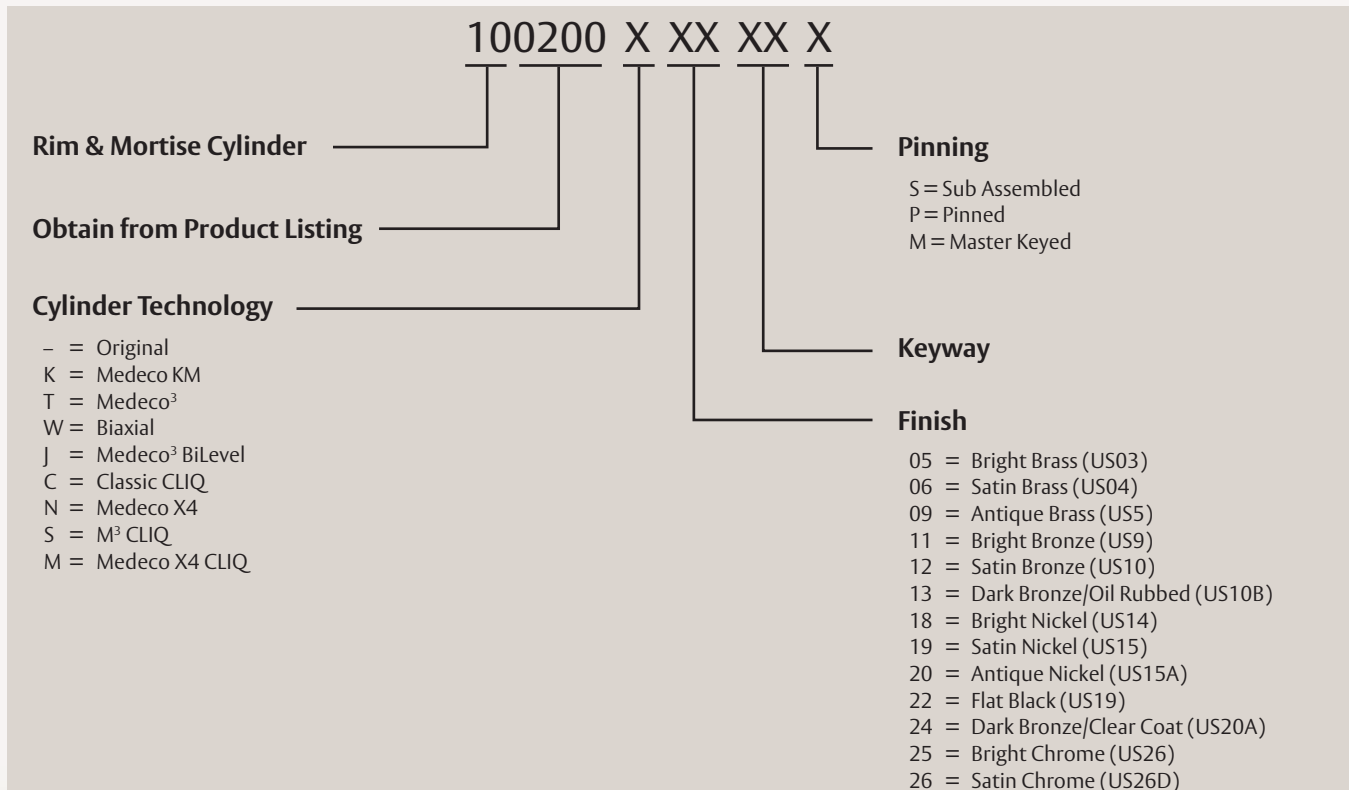

\*\*Refer to the eCylinder section for more detail on specific technologies available and pricing. Technologies are represented by the following letters: T = Medeco<sup>3</sup>, S = M<sup>3</sup> CLIQ, J = Medeco<sup>3</sup> BiLevel, W = Biaxial, V = Medeco Biaxial CLIQ, K = Medeco KM, N = Medeco X4, C = Classic CLIQ, M = Medeco X4 CLIQ, "-" = Original, Z = Medeco Original KW CLIQ, G = Medeco XT \*\*\*See key section for surcharges for custom coined cut keys or special stamping requirements.  
**Note: (P)** refers to **Pinned** and **(S)** to **Sub-Assembled** at the end of each part string in the price book.

## Standard Mortise Cylinders

Description	Part Number	M <sup>3</sup>	BiLevel	X4	Biax/Orig	KeyMark
1" 5 Pin Mortise Cylinder – (6 pin for Medeco X4)	100100 (P)	\$138.00	\$75.03	\$94.30	\$143.25	\$98.35
	100100 (S)	\$125.00	\$68.13	\$81.30	\$130.25	\$85.35
1" 5 Pin Mortise Cylinder with 120° notch along top of shell for alternate retaining location	100101 (P)	\$138.00	\$75.03		\$143.25	
	100101 (S)	\$125.00	\$68.13		\$130.25	
1-1/8" 6 Pin Mortise Cylinder	100200 (P)	\$138.00	\$75.03	\$94.30	\$143.25	\$98.35
	100200 (S)	\$125.00	\$68.13	\$81.30	\$130.25	\$85.35
1-1/4" 6 Pin Mortise Cylinder	100500 (P)	\$143.00	\$77.75	\$95.40	\$148.46	\$99.56
	100500 (S)	\$130.00	\$70.85	\$82.40	\$135.46	\$86.56
1-3/8" 6 Pin Mortise Cylinder	105100 (P)	\$150.00	\$81.56	\$106.80	\$155.75	\$111.35
	105100 (S)	\$137.00	\$74.67	\$93.80	\$142.75	\$98.35
1-1/2" 6 Pin Mortise Cylinder	105200 (P)	\$201.00	\$109.36	\$142.40	\$208.90	
	105200 (S)	\$188.00	\$102.46	\$129.40	\$195.90	
1-5/8" 6 Pin Mortise Cylinder	105300 (P)	\$207.00	\$112.63	\$148.40	\$215.15	\$154.95
	105300 (S)	\$194.00	\$105.73	\$135.40	\$202.15	\$141.95
1-3/4" 6 Pin Mortise Cylinder	105400 (P)	\$213.00	\$115.90	\$154.40	\$221.40	\$161.20
	105400 (S)	\$200.00	\$109.00	\$141.40	\$208.40	\$148.20
2" 6 Pin Mortise Cylinder	105500 (P)	\$225.00	\$122.44	\$166.40	\$233.90	\$173.70
	105500 (S)	\$212.00	\$115.54	\$153.40	\$220.90	\$160.70
2-1/4" 6 Pin Mortise Cylinder	105600 (P)	\$236.00	\$128.44		\$245.37	
	105600 (S)	\$223.00	\$121.53		\$232.37	
2-1/2" 6 Pin Mortise Cylinder	105700 (P)	\$249.00	\$135.52	\$190.40	\$258.91	\$198.71
	105700 (S)	\$236.00	\$128.62	\$177.40	\$245.91	\$185.71
2-3/8" 6 Pin Mortise Cylinder	105904 (P)	\$243.00			\$252.66	
	105904 (S)	\$230.00			\$239.66	
2-3/4" 6 Pin Mortise Cylinder	105104 (P)	\$263.00			\$273.50	
	105104 (S)	\$250.00			\$260.50	
3-1/4" 6 Pin Mortise Cylinder	105900 (P)	\$285.00		\$285.00	\$296.42	
	105900 (S)	\$272.00		\$272.00	\$283.42	
4-1/8" 6 Pin Mortise Cylinder	105800 (P)	\$326.00			\$339.15	
	105800 (S)	\$313.00			\$326.15	
5" 6 Pin Mortise Cylinder	105901 (P)	\$365.00			\$379.78	
	105901 (S)	\$352.00			\$366.78	
6-7/8" 6 Pin Mortise Cylinder	105903 (P)	\$511.00			\$531.92	
	105903 (S)	\$498.00			\$518.92	
8" 6 Pin Mortise Cylinder	105902 (P)	\$511.00			\$531.92	
	105902 (S)	\$498.00			\$518.92	

\*\*Refer to the eCylinder section for more detail on specific technologies available and pricing. Technologies are represented by the following letters:  
T = Medeco<sup>3</sup>, S = M<sup>3</sup> CLIQ, J = Medeco<sup>3</sup> BiLevel, W = Biaxial, V = Medeco Biaxial CLIQ, K = Medeco KM, N = Medeco X4, C = Classic CLIQ, M = Medeco X4 CLIQ,  
“-” = Original, Z = Medeco Original KW CLIQ, G = Medeco XT \*\*\*See key section for surcharges for custom coined cut keys or special stamping requirements.  
**Note: (P)** refers to **Pinned** and **(S)** to **Sub-Assembled** at the end of each part string in the price book.

## Residential Mortise Cylinders

Description	Part Number	M <sup>3</sup>	BiLevel	X4	Biax/Orig	KeyMark
1" 5 pin, Thin head mortise cylinder	1014506 (P)	\$138.00			\$143.25	
	1014609 (S)	\$125.00			\$130.25	
1-1/8" 5 pin, Thin head mortise cylinder	1014500 (P)	\$138.00			\$143.25	
	1014500 (S)	\$125.00			\$130.25	
1-1/4" 5 pin, Thin head mortise cylinder	1014501 (P)	\$143.00			\$148.46	
	1014501 (S)	\$130.00			\$135.46	
1-3/8" 5 pin, Thin head mortise cylinder	1014502 (P)	\$150.00			\$155.75	
	1014502 (S)	\$137.00			\$142.75	
1-1/2" 5 pin, Thin head mortise cylinder	1014503 (P)	\$201.00			\$208.90	
	1014503 (S)	\$188.00			\$195.90	
1-5/8" 5 pin, Thin head mortise cylinder	1014504 (P)	\$205.00			\$213.06	
	1014504 (S)	\$192.00			\$200.06	
1-3/4" 5 pin, Thin head mortise cylinder	1014505 (P)	\$211.00			\$219.32	
	1014505 (S)	\$198.00			\$206.32	
2" 5 pin, Thin head mortise cylinder	1014507 (P)	\$218.00			\$226.61	
	1014507 (S)	\$205.00			\$213.61	
2-1/4" 5 pin, Thin head mortise cylinder	1014508 (P)	\$227.00			\$235.99	
	1014508 (S)	\$214.00			\$222.99	
2-1/2" 5 pin, Thin head mortise cylinder	1014509 (P)	\$237.00			\$246.41	
	1014509 (S)	\$224.00			\$233.41	
1-1/8" 6 pin, Thin head mortise cylinder	1014600 (P)	\$138.00			\$143.25	
	1014600 (S)	\$125.00			\$130.25	
1-1/4" 6 pin, Thin head mortise cylinder	1014601 (P)	\$143.00			\$148.46	
	1014601 (S)	\$130.00			\$135.46	
1-3/8" 6 pin, Thin head mortise cylinder	1014602 (P)	\$150.00			\$155.75	
	1014602 (S)	\$137.00			\$142.75	
1-1/2" 6 pin, Thin head mortise cylinder	1014603 (P)	\$201.00			\$208.90	
	1014603 (S)	\$188.00			\$195.90	
1-5/8" 6 pin, Thin head mortise cylinder	1014604 (P)	\$205.00			\$213.06	
	1014604 (S)	\$192.00			\$200.06	
1-3/4" 6 pin, Thin head mortise cylinder	1014605 (P)	\$211.00			\$219.32	
	1014605 (S)	\$198.00			\$206.32	
2" 6 pin, Thin head mortise cylinder	1014607 (P)	\$218.00			\$226.61	
	1014607 (S)	\$205.00			\$213.61	
2-1/4" 6 pin, Thin head mortise cylinder	1014608 (P)	\$227.00			\$235.99	
	1014608 (S)	\$214.00			\$222.99	
2-1/2" 6 pin, Thin head mortise cylinder	1014609 (P)	\$138.00			\$143.25	
	1014609 (S)	\$125.00			\$130.25	

\*\*Refer to the eCylinder section for more detail on specific technologies available and pricing. Technologies are represented by the following letters:  
T = Medeco<sup>3</sup>, S = M<sup>3</sup> CLIQ, J = Medeco<sup>3</sup> BiLevel, W = Biaxial, V = Medeco Biaxial CLIQ, K = Medeco KM, N = Medeco X4, C = Classic CLIQ, M = Medeco X4 CLIQ,  
“-” = Original, Z = Medeco Original KW CLIQ, G = Medeco XT \*\*\*See key section for surcharges for custom coined cut keys or special stamping requirements.  
**Note: (P)** refers to **Pinned** and **(S)** to **Sub-Assembled** at the end of each part string in the price book.

## Jumbo/Mogul Mortise Cylinders

Description	Part Number	M <sup>3</sup>	BiLevel	X4	Biax/Orig	KeyMark
6 Pin Jumbo Mortise Cylinder (1-19/64" Long, 1-3/8" Shell Dia.) Corbin Russwin® Master Ring Cylinder Replacement	101350 (P)	\$181.00	\$98.46	\$143.40	\$188.06	\$149.46
	101350 (S)	\$168.00	\$91.56	\$130.40	\$175.06	\$136.46
6 Pin 1-1/4" Mogul Cylinder for Prison Locks (1-1/4" Long, 2" Shell Dia.)	104001 (P)	\$189.00			\$196.39	
	104001 (S)	\$176.00			\$183.39	
6 Pin 1-1/4" Mogul Mortise Cylinder 2" Shell Dia., Limited Rotation: CK 145° CCW and CW, MK 360° CCW and CW	104003 (P)	\$189.00			\$196.39	
	104003 (S)	\$176.00			\$183.39	
6 Pin 1-1/4" Mogul Mortise Cylinder 2" Shell Dia., Limited Rotation: CK 145° CW, MK 360° CCW and CW	108001 (P)	\$189.00			\$196.39	
	108001 (S)	\$176.00			\$183.39	
6 Pin 1-1/4" Mogul Mortise Cylinder 2" Shell Dia., Limited Rotation: CK 145° CCW, MK 360° CCW and CW	108002 (P)	\$189.00			\$196.39	
	108002 (S)	\$176.00			\$183.39	

## Limited Rotation Mortise Cylinders

Description	Part Number	M <sup>3</sup>	BiLevel	X4	Biax/Orig	KeyMark
6 Pin 1-1/4" Mortise Cylinder with Raised Plug, Limited Rotation: CK 145° CW and 145° CCW	100500H (P)	\$179.50			\$184.96	
	100500H (S)	\$166.50			\$171.96	
6 Pin 1-1/4" Mortise Cylinder Hotel Function, Uses Spring Loaded Stop Pins with Notched and Un-Notched Keys to Provide Directional and Limited Rotation	100501 (P)	\$171.00			\$177.64	
	100501 (S)	\$158.00			\$164.64	
6 Pin 1-3/16" Length Mortise Cylinder Limited Rotation: CK 145° CCW, MK 360° CCW and CW	490078 (P)	\$157.00			\$163.05	
	490078 (S)	\$144.00			\$150.05	
6 Pin 1-3/16" Length Mortise Cylinder, Limited Rotation: CK 145° CW, MK 360° CCW and CW	490079 (P)	\$157.00			\$163.05	
	490079 (S)	\$144.00			\$150.05	

\*\*Refer to the eCylinder section for more detail on specific technologies available and pricing. Technologies are represented by the following letters:  
T = Medeco<sup>3</sup>, S = M<sup>3</sup> CLIQ, J = Medeco<sup>3</sup> BiLevel, W = Biaxial, V = Medeco Biaxial CLIQ, K = Medeco KM, N = Medeco X4, C = Classic CLIQ, M = Medeco X4 CLIQ,  
“-” = Original, Z = Medeco Original KW CLIQ, G = Medeco XT \*\*\*See key section for surcharges for custom coined cut keys or special stamping requirements.  
**Note: (P)** refers to **Pinned** and **(S)** to **Sub-Assembled** at the end of each part string in the price book.

## Specialty Mortise Cylinders

Description	Part Number	M <sup>3</sup>	BiLevel	X4	Biax/Orig	KeyMark
5 Pin Otis® Elevator Mortise Cylinder, 1 Key Pull Position	100903 (P)	\$153.00			\$158.88	
	100903 (S)	\$140.00			\$145.88	
5 Pin Otis® Elevator Mortise Cylinder, 2 Key Pull Positions (not used in MK systems)	100909 (P)	\$175.00			\$181.80	
	100909 (S)	\$162.00			\$168.80	
1-7/32" 6 Pin Mortise Cylinder with Mini Micro Switch, 7 Amp, SPDT, 1 Key Pull (requires quick connect leads: CP-270511)	100200A (P)	\$220.90	\$157.93	\$155.70	\$226.15	\$159.75
	100200A (S)	\$207.90	\$151.03	\$142.70	\$213.15	\$146.75
1-1/8" 6 Pin Concealed Face Mortise Cylinder for Schlage® "K" Locks, Trim Style 712, 714, 202	100202 (P)	\$157.00	\$85.38	\$112.20	\$163.05	\$117.05
	100202 (S)	\$144.00	\$78.48	\$99.20	\$150.05	\$104.05
1-1/8" 6 Pin Mortise Cylinder with Extended Plug & Second Cam Washer Reversed to Close Bottom of Keyway	104207 (P)	\$167.70	\$81.56		\$155.75	
	104207 (S)	\$137.00	\$74.67		\$142.75	
1-1/8" 6 Pin Mortise Cylinder with Extended Plug	104207A (P)	\$150.00	\$81.56		\$155.75	
	104207A (S)	\$137.00	\$74.67		\$142.75	
6 Pin SFIC Mortise Cylinder with 15 Amp Micro Switch	320200B (P)	\$344.00			\$353.32	
	320200B (S)	\$331.00			\$340.32	
1 1/4" 6 Pin Mortise Cylinder for VingCard® Persona®	490214 (P)	\$143.00	\$77.75		\$148.46	
	490214 (S)	\$130.00	\$70.85		\$135.46	

## Mortise Cylinder Plugs

Description	Part Number	Price
Plug for 10-0200 (Medeco Original®)	12005002 -	\$53.40
Plug for 10W0200 (Medeco Biaxial®)	12005006 W	\$53.40
Plug for 10T0200 (Medeco <sup>3</sup> ®)	1200500 T	\$53.40
Plug for 10-0500 (Medeco Original®)	12020002 -	\$55.64
Plug for 10W0500 (Medeco Biaxial®)	12020006 W	\$55.64
Plug for 10T0500 (Medeco <sup>3</sup> ®)	1202000 T	\$53.40
Plug for 10-0100 (Medeco Original®)	12021002 -	\$55.64
Plug for 10W0100 (Medeco Biaxial®)	12021006 W	\$55.64
Plug for 10T0100 (Medeco <sup>3</sup> ®)	1202100 T	\$53.40
Plug for 10J0500 (Medeco <sup>3</sup> BiLevel®)	1239000 J	\$53.40
Plug for 10J0100 (Medeco <sup>3</sup> BiLevel®)	1239100 J	\$53.40
Plug for 10J0200 (Medeco <sup>3</sup> BiLevel®)	1251300 J	\$53.40

Include finish and keyway with all part #'s .

Medeco<sup>3</sup> or Medeco BiLevel Slider package sold separately .

\*\*Refer to the eCylinder section for more detail on specific technologies available and pricing. Technologies are represented by the following letters:  
T = Medeco<sup>3</sup>, S = M<sup>3</sup> CLIQ, J = Medeco<sup>3</sup> BiLevel, W = Biaxial, V = Medeco Biaxial CLIQ, K = Medeco KM, N = Medeco X4, C = Classic CLIQ, M = Medeco X4 CLIQ,  
“-” = Original, Z = Medeco Original KW CLIQ, G = Medeco XT \*\*\*See key section for surcharges for custom coined cut keys or special stamping requirements.  
**Note: (P)** refers to **Pinned** and **(S)** to **Sub-Assembled** at the end of each part string in the price book.



## Mortise Cams

	Description	Part Number	Price
	Corbin Russwin® Type	CT-Z00	\$4.00
	Standard Yale® Type	CT-Z01	\$4.00
	Adams Rite® Type	CT-Z02	\$4.00
	Keil® Norwalk Type	CT-Z04	\$4.00
	Schlage® Type	CT-Z05	\$4.00
	Medium Yale® Type	CT-Z06	\$4.00
	Segal® Type	CT-Z07	\$4.00
	Lockwood® Type	CT-Z08	\$4.00
	Corbin Russwin® Type	CT-Z09	\$4.00
	Segal® Deadbolt Type	CT-Z16	\$4.00
	Corbin Russwin® Oversized Jumbo	CT-Z17	\$4.00
	For Night Deposit Lock	CT-Z18	\$4.00
	General® Lock	CT-Z19	\$4.00
	Sargent® Type	CT-Z20	\$4.00
	Ruko® Type	CT-Z21	\$4.00

\*\*Refer to the eCylinder section for more detail on specific technologies available and pricing. Technologies are represented by the following letters:  
T = Medeco<sup>3</sup>, S = M<sup>3</sup> CLIQ, J = Medeco<sup>3</sup> BiLevel, W = Biaxial, V = Medeco Biaxial CLIQ, K = Medeco KM, N = Medeco X4, C = Classic CLIQ, M = Medeco X4 CLIQ,  
“-” = Original, Z = Medeco Original KW CLIQ, G = Medeco XT \*\*\*See key section for surcharges for custom coined cut keys or special stamping requirements.  
**Note: (P)** refers to **Pinned** and **(S)** to **Sub-Assembled** at the end of each part string in the price book.

## Mortise Cams

	Description	Part Number	Price
	Falcon® Type	CT-Z22	\$4.00
	Schlage® Type	CT-Z34	\$4.00
	Mogul Lock	CT-Z45	\$4.00
	Yale® Mortise After 1982	CT-Z47	\$4.00
	Dominion®	CT-Z48	\$4.00
	Corbin Russwin® Jumbo	CT-Z55	\$4.00
	Yale® Medium After 1982	CT-Z56	\$4.00
	Medeco Residential	CT-Z57	\$4.00
	Falcon® Type	CT-Z58	\$4.00
	Corbin Russwin® Master Ring clover leaf for deadbolt function locks made since 6/93	CT-Z59	\$4.00
	Hook Type for Detention Locks	CT-Z61	\$4.70
	Mogul clover leaf	CT-Z69	\$11.10
	Best® Hotel Function Reversible Lock	CT-Z70	\$4.00
	Marks® J Type	CT-Z84	\$4.00
	VingCard® Persona®	CT-Z87	\$4.00
	Falcon® Type	CT-Z99	\$4.00

\*\*Refer to the eCylinder section for more detail on specific technologies available and pricing. Technologies are represented by the following letters: T = Medeco<sup>3</sup>, S = M<sup>3</sup> CLIQ, J = Medeco<sup>3</sup> BiLevel, W = Biaxial, V = Medeco Biaxial CLIQ, K = Medeco KM, N = Medeco X4, C = Classic CLIQ, M = Medeco X4 CLIQ, “-” = Original, Z = Medeco Original KW CLIQ, G = Medeco XT \*\*\*See key section for surcharges for custom coined cut keys or special stamping requirements.  
**Note: (P)** refers to **Pinned** and **(S)** to **Sub-Assembled** at the end of each part string in the price book.

## Mortise Components

Description	Part Number	Price
1-1/2" Dia. Threaded Adapter Ring for Corbin® Jumbo Mortise Cylinder (converts conventional size Mortise Cylinder to Jumbo thread size) Contains: CP-050131 Adapter Ring and CP-011013-030		
# 8-32 x 3/16" Set Screws	940010	\$48.10
Medeco <sup>3</sup> Slider Package, Includes Slider & Spring	94-0174-XX	\$12.00
Medeco <sup>3</sup> BiLevel slider package	94-0227-XX	\$12.00
# 2-56 UNC x 5/16" Length Phillips® Head Screws- Stainless Steel (used to attach cams to Mortise Cylinders)	CP-010203-050	\$0.21
Set Screws (for Medeco X4 pin chamber) # 6-32 x 1/8"	CP-011011-020	\$0.22
Set Screws (for High Security pin chambers) #8-32 x 1/8"	CP-011013-020	\$0.26
Cam Washer for Mortise Cylinders	CP-021011	\$0.71
Sidebar Spring-Stainless Steel	CP-030018	\$0.09
Mounting Nut for Mortise Cylinder 1.150"-32 UNS Inside Dia.	CP-050120	\$10.60
5 Pin Sidebar Assembly, .123" high for Door Hardware Cylinders	CP-084571	\$7.20
6 Pin Sidebar Assembly, .123" high for Door Hardware Cylinders	CP-084671	\$7.20

## Rim Cylinders

Description	Part Number	M <sup>3</sup>	BiLevel	X4	Biax/Orig	KeyMark
5 Pin 1-1/16" Rim Cylinder - Horizontal Tailpiece	100300H (P)	\$130.70	\$77.20	\$102.70	\$147.42	\$107.02
	100300H (S)	\$129.00	\$70.31	\$89.70	\$134.42	\$94.02
5 Pin 1-1/16" Rim Cylinder - Vertical Tailpiece	100300V (P)	\$142.00	\$77.20	\$102.70	\$147.42	\$107.02
	100300V (S)	\$129.00	\$70.31	\$89.70	\$134.42	\$94.02
5 Pin 1-1/16" Rim Cylinder, Sargent® Mounting Style, Horizontal Tailpiece	100305H (P)	\$142.00	\$77.20	\$102.70	\$147.42	\$107.02
	100305H (S)	\$129.00	\$70.31	\$89.70	\$134.42	\$94.02
5 Pin 1-1/16" Rim Cylinder, Sargent® Mounting Style, Vertical Tailpiece	100305V (P)	\$142.00	\$77.20	\$102.70		
	100305V (S)	\$129.00	\$70.31	\$89.70		
5 Pin 1-1/16" Rim Cylinder, 180 Degree Lazy Motion	100600 (P)	\$151.00	\$82.11		\$156.80	
	100600 (S)	\$138.00	\$75.21		\$143.80	
6 Pin, 1-1/8" Rim Cylinder Horizontal Tailpiece	100400H (P)	\$151.00	\$82.11	\$102.30	\$156.80	\$106.90
	100400H (S)	\$138.00	\$75.21	\$89.30	\$143.80	\$93.90
6 Pin, 1-1/8" Rim Cylinder Vertical Tailpiece	100400V (P)	\$151.00	\$82.11	\$102.30	\$156.80	\$106.90
	100400V (S)	\$138.00	\$75.21	\$89.30	\$143.80	\$93.90
6 Pin 1-1/8" Rim Cylinder- Sargent® Mounting Style, Horizontal Tailpiece	100403H (P)	\$151.00	\$82.11	\$102.30	\$156.80	\$106.90
	100403H (S)	\$138.00	\$75.21	\$89.30	\$143.80	\$93.90
6 Pin 1-1/8" Rim Cylinder- Sargent® Mounting Style, Vertical Tailpiece	100403V (P)	\$151.00	\$82.11	\$102.30	\$156.80	\$106.90
	100403V (S)	\$138.00	\$75.21	\$89.30	\$143.80	\$93.90
6 Pin 1-1/8" Rim Cylinder, 180 Degree Lazy Motion	100700 (P)	\$151.00	\$82.11	\$102.30	\$156.80	\$106.90
	100700 (S)	\$138.00	\$75.21	\$89.30	\$143.80	\$93.90
6 Pin Jumbo Rim Cylinder Corbin Russwin® Master Ring Cylinder Replacement	101355 (P)	\$191.00			\$198.48	
	101355 (S)	\$178.00			\$185.48	
6 Pin 1-15/32" Rim Cylinder with Extended Plug and Horizontal Tailpiece	104407HA (P)	\$149.00			\$154.31	
	104407HA (S)	\$136.00			\$141.31	

6 Pin high security cylinders are available in 7 Pin in Medeco X4.  
Check the eCylinder section for pricing and technology available.

\*\*Refer to the eCylinder section for more detail on specific technologies available and pricing. Technologies are represented by the following letters:  
T = Medeco<sup>3</sup>, S = M<sup>3</sup> CLIQ, J = Medeco<sup>3</sup> BiLevel, W = Biaxial, V = Medeco Biaxial CLIQ, K = Medeco KM, N = Medeco X4, C = Classic CLIQ, M = Medeco X4 CLIQ,  
“-” = Original, Z = Medeco Original KW CLIQ, G = Medeco XT \*\*\*See key section for surcharges for custom coined cut keys or special stamping requirements.  
**Note: (P)** refers to **Pinned** and **(S)** to **Sub-Assembled** at the end of each part string in the price book.

### Rim Cylinder Plugs

Description	Part Number	Price
Plug for 10-0300H or 10-0300V (Medeco Original®)	12001002 -	\$55.64
Plug for 10W0300H & 10W0300V (Medeco Biaxial®)	12001006 W	\$53.40
Plug for 10T0300 (Medeco <sup>3</sup> ®)	1200100 T	\$53.40
Plug for 10-0400H or 10-0400V (Medeco Original®)	12030002 -	\$55.64
Plug for 10W0400H & 10W0400V (Medeco Biaxial®)	12030006 W	\$55.64
Plug for 10T0400 (Medeco <sup>3</sup> ®)	1203000 T	\$53.40
Plug for 10J0300 (Medeco BiLevel®)	1238900 J	\$53.40
Plug for 10J0400 (Medeco BiLevel®)	1251200 J	\$53.40

Add finish and keyway to all part #'s .

Medeco<sup>3</sup> or Medeco BiLevel Slider package sold separately .

### Rim Components





Description	Part Number	Price
Medeco <sup>3</sup> Slider Package, Includes Slider & Spring	94-0174-XX	\$12.00
Medeco BiLevel slider package	94-0227-XX	\$12.00
Set Screws (for Medeco X4 pin chamber) #6-32 x1/8"	CP-011011-020	\$0.22
Set Screws (for HS pin chambers) #8-32 x1/8"	CP-011013-020	\$0.26
Rim Cylinder Mounting Screws (#12-24 UNF x 1 57/64" Length)	CP-012917-000	\$0.50
Rim Cylinder Plug Retainer	CP-020010	\$0.59
Screw-on Cap Rim Tailpiece Retainer	CP-021121	\$12.90
Sidebar Spring-Stainless Steel	CP-030018	\$0.09
Back of Plug Roll Pin 3/32" Dia. x .437" Length	CP-060203	\$0.39
5 Pin Sidebar Assembly, .123" high for Door Hardware Cylinders	CP-084571	\$7.20
6 Pin Sidebar Assembly, .123" high for Door Hardware Cylinders	CP-084671	\$7.20
Rim Cylinder Mounting Plate	CP-180031	\$1.60

\*\*Refer to the eCylinder section for more detail on specific technologies available and pricing. Technologies are represented by the following letters:

T = Medeco<sup>3</sup>, S = M<sup>3</sup> CLIQ, J = Medeco<sup>3</sup> BiLevel, W = Biaxial, V = Medeco Biaxial CLIQ, K = Medeco KM, N = Medeco X4, C = Classic CLIQ, M = Medeco X4 CLIQ, "-" = Original, Z = Medeco Original KW CLIQ, G = Medeco XT \*\*\*See key section for surcharges for custom coined cut keys or special stamping requirements.

**Note: (P)** refers to **Pinned** and **(S)** to **Sub-Assembled** at the end of each part string in the price book.

## Collars &amp; Cylinder Rings

	Description	Part Number	Price
	Tapered Cylinder Collar	94-0188-XX	\$15.00
	1/4" Thick Spacer Ring 1.165" Inside Diameter x 1.375 Outside Diameter	CP-070011	\$25.20
	1/8" Thick Spacer Ring 1.165" Inside Diameter x 1.375 Outside Diameter	CP-070451	\$20.10
	Raised Cylinder Ring	CP-180021	\$9.00
	Flush Cylinder Ring	CP-180041	\$8.80
	Adjustable Cylinder Collar	CP-160180	\$25.20

## Rim Tailpieces

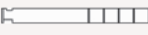
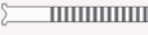
	Description	Part Number	Price
	Tailpiece for Rim Cylinder (155/64") Before 1980, After 1983	CT-Y02	\$4.00
	Lazy Motion Tailpiece (2 29/64")	CT-Y08	\$4.00
	Tailpiece for Rim Cylinder (2 9/16")	CT-Y32	\$4.00

\*\*Refer to the eCylinder section for more detail on specific technologies available and pricing. Technologies are represented by the following letters:  
T = Medeco<sup>3</sup>, S = M<sup>3</sup> CLIQ, J = Medeco<sup>3</sup> BiLevel, W = Biaxial, V = Medeco Biaxial CLIQ, K = Medeco KM, N = Medeco X4, C = Classic CLIQ, M = Medeco X4 CLIQ,  
“-” = Original, Z = Medeco Original KW CLIQ, G = Medeco XT \*\*\*See key section for surcharges for custom coined cut keys or special stamping requirements.  
**Note: (P)** refers to **Pinned** and **(S)** to **Sub-Assembled** at the end of each part string in the price book.

# Key-in-Knob/Lever Cylinders

FEATURES	Medeco <sup>3</sup>	BiLevel	Medeco X4	CLIQ	Medeco XT
Utility patented key control provides protection from unauthorized duplication of keys	●	●	●	●	●
UL437 Listing and BHMA Certification provide validation of high security from recognized, independent testing laboratories	●				
Triple locking principle provides pick resistance and large numbers of combinations for master keying flexibility to accommodate systems of virtually any size	●				
Hardened steel inserts in the cylinder face provide proven drill resistance	●				
Nickel plated pins provide exceptional wear resistance and additional hardened stainless steel pins provide drill resistance	●	●			
Solid nickel silver pins provide exceptional wear resistance			●		
Retrofits into virtually any manufacturers' locksets for cost effective improved security	●	●	●	●	●
High security and key control may be incorporated in a single system for cost effective system flexibility	●	●		●	
Keys may be integrated with Hybrid proximity head for greater system retrofit	●	●	●	●	

## Medeco<sup>3</sup> Premium High Security

For effective mechanical protection against most forms of attack as well as protection against unauthorized duplicate keys, Medeco<sup>3</sup> cylinders are recommended. Security features including hardened steel components, pins that must be elevated, rotated, and interact with both a sidebar and a slider, and additional pick resistant features make Medeco<sup>3</sup> the cylinder of choice to protect people, property and information.

## Medeco X4 Patented Key Control

Medeco X4 cylinders offer patented control against unauthorized duplication of keys without the additional security features protecting against force or surreptitious attack.

## Medeco<sup>3</sup> BiLevel Patented Key Control

Medeco<sup>3</sup> BiLevel cylinders may be incorporated into a master key system with Medeco<sup>3</sup> high security, offering protection against all types of attack where needed, and patented key control cylinders for areas requiring less protection. BiLevel cylinders offer patented control against unauthorized duplication of keys without the additional security features protecting against force or surreptitious attack.

## Intelligent Key Solutions

Many of the cylinders in this section are also available with an Intelligent Key solution. See the Intelligent Key section for more details.



# Key-in-Knob/Lever Cylinders

Medeco<sup>3</sup> Key-in-Knob cylinders are designed to retrofit knob type cylindrical locksets, lever type cylindrical locksets, padlocks and bored type auxiliary deadlatches and deadlocks. The 20 series Key-in-Knob cylinders are UL437 Listed for drill and pick resistance, and those that incorporate the Medeco<sup>3</sup> design offer utility patented key control.



## Patented Key Control

Protects against unauthorized duplication of your keys.



## Uses Existing Hardware

Medeco offers the largest selection of retrofit KIK and KIL cylinders that reduce cost by eliminating the need to replace existing hardware.



## Can Be Master Keyed

Medeco<sup>3</sup> and BiLevel KIK/KIL cylinders can be master keyed into a system containing Medeco BiLevel and Medeco<sup>3</sup> mechanical as well as Medeco<sup>3</sup> CLIQ eCylinders.



## Protection From Physical Attack

Medeco<sup>3</sup> KIK/KIL cylinders are UL 437 listed and use hardened steel inserts positioned in critical areas of the cylinder, providing a high degree of drill and picking resistance.



## Special Angle Cut Keys

Requires a special key cutting machine and access to Medeco specific blanks, available in a variety of restrictions to support every need.



## Picking and Bumping Protection

Medeco<sup>3</sup> cylinders use a sidebar that prevent the key from rotating until it is elevated, rotated and aligned in the correct position. This feature protects against bumping and picking attacks.

## Applications:

Over 100 different cylinder designs and tailpiece configurations enable Medeco to offer the largest retrofit capability in the industry. More retrofit cylinders means fewer replacements of the complete lockset.

## Warranty:

Warranted for two (2) years against manufacturer's defects. See the Medeco<sup>®</sup> limited warranty for full details.

## Technical Information:

- ANSI A156.30 Level A certification assures patent protected key control and physical strength
- ANSI A156.5 Grade 1 certification assures consistent quality for heavy use applications
- Cylinders with tailpiece packages contain one cylinder and a variety of different tailpieces, providing a greater retrofit capability, while at the same time reducing the amount on inventory required
- All Medeco cylinders are constructed of durable machined brass components, designed to last the life of your equipment

## Finishes:

- Available in all standard finishes to match existing hardware

## Available Key Technologies:

### Mechanical:

- Medeco<sup>3</sup>
- Medeco<sup>3</sup> BiLevel
- Medeco X4\*

### eCylinder:

- M<sup>3</sup> CLIQ
- Classic CLIQ
- Medeco XT
- Medeco X4 CLIQ

## How To Order Key-in-Knob/Lever Cylinders

Complete part numbers are required for all orders. To determine the correct part number, fill in the "X's" in sequential order.

1	2	3	4	5						
<b>200200S1</b> <b>base part #</b>	<b>T</b> <b>cylinder</b>	<b>05</b> <b>finish</b>	<b>LT</b> <b>keyway</b>	<b>S</b> <b>pinning</b>						
Refer to pages 77-91 for descriptions and technical specifications to find the corresponding base part number.	<ul style="list-style-type: none"> <li>- = Original</li> <li>K = Medeco KM</li> <li>T = Medeco<sup>3</sup></li> <li>W = Biaxial</li> <li>J = Medeco<sup>3</sup> BiLevel</li> <li>C = Classic CLIQ</li> <li>N = Medeco X4</li> <li>S = M<sup>3</sup> CLIQ</li> <li>M = Medeco X4 CLIQ</li> </ul>	Refer to the inside back cover of this catalog for finish options. Include the corresponding two digit finish number.  Upcharge for split finish.	Insert keyway if known or contact Customer Service for help.	<table border="1"> <thead> <tr> <th>S =</th> <th>P =</th> <th>M =</th> </tr> </thead> <tbody> <tr> <td> <b>Sub-Assembled (Uncombined)</b>                No additional information needed             </td> <td> <b>Pinned (Combined)</b>                Keyed alike (KA)                Keyed different (KD)                2 keys per cylinder             </td> <td> <b>Master Keyed</b>                Provide specific pinning or contact Customer Service for support                 Must specify quantity for keys.             </td> </tr> </tbody> </table>	S =	P =	M =	<b>Sub-Assembled (Uncombined)</b> No additional information needed	<b>Pinned (Combined)</b> Keyed alike (KA) Keyed different (KD) 2 keys per cylinder	<b>Master Keyed</b> Provide specific pinning or contact Customer Service for support  Must specify quantity for keys.
S =	P =	M =								
<b>Sub-Assembled (Uncombined)</b> No additional information needed	<b>Pinned (Combined)</b> Keyed alike (KA) Keyed different (KD) 2 keys per cylinder	<b>Master Keyed</b> Provide specific pinning or contact Customer Service for support  Must specify quantity for keys.								

### BUILD A KEY-IN-KNOB/LEVER PART #:

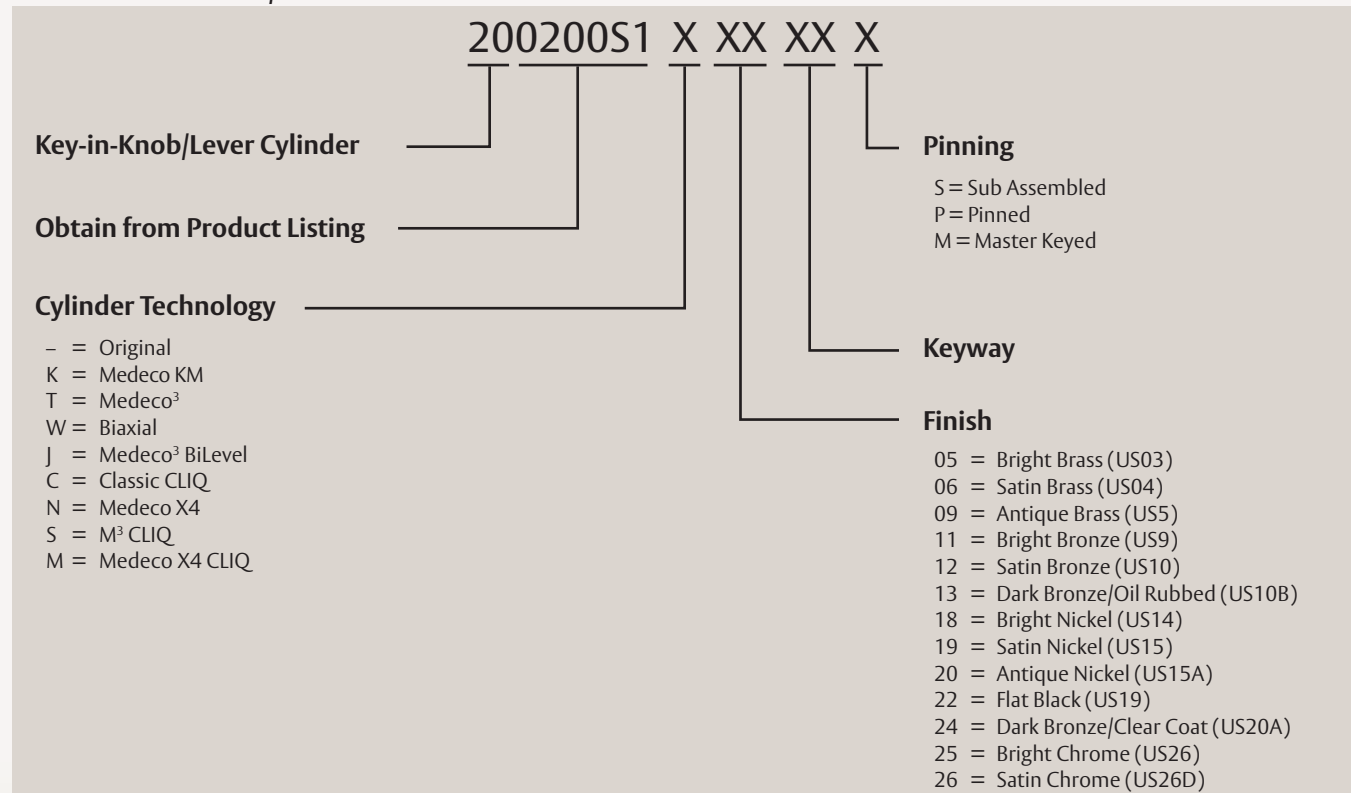

\*\*Refer to the eCylinder section for more detail on specific technologies available and pricing. Technologies are represented by the following letters: T = Medeco<sup>3</sup>, S = M<sup>3</sup> CLIQ, J = Medeco<sup>3</sup> BiLevel, W = Biaxial, V = Medeco Biaxial CLIQ, K = Medeco KM, N = Medeco X4, C = Classic CLIQ, M = Medeco X4 CLIQ, "-" = Original, Z = Medeco Original KW CLIQ, G = Medeco XT \*\*\*See key section for surcharges for custom coined cut keys or special stamping requirements.  
**Note: (P)** refers to **Pinned** and **(S)** to **Sub-Assembled** at the end of each part string in the price book.







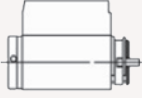

## Alarm Lock Cylinder

Description	Part Number	M <sup>3</sup>	BiLevel	X4	Biax/Orig	KeyMark
 6 Pin Cylinder for Alarm Lock Trilogy® T1, T2, T3	20200V1 (P)	\$130.00	\$70.67	\$82.40	\$134.91	\$86.01
	20200V1 (S)	\$117.00	\$63.77	\$69.40	\$121.91	\$73.01

## Anderson® Cylinder

Description	Part Number	M <sup>3</sup>	BiLevel	X4	Biax/Orig	KeyMark
 5 Pin Cylinder for Anderson® Doors Frenchwood Hinged and Out Swinging Doors Estate and Metro Design	20110039 (P)	\$130.00	\$70.67		\$134.91	
	20110039 (S)	\$117.00	\$63.77		\$121.91	

## Arrow Cylinder



Description	Part Number	M <sup>3</sup>	BiLevel	X4	Biax/Orig	KeyMark
 6 Pin Cylinder Package for Arrow® “MK” Series includes CT-Y70, CT-Y73, CP-160321	20200A1 (P)	\$131.70	\$72.36	\$84.10	\$136.61	\$87.71
	20200A1 (S)	\$118.70	\$65.47	\$71.10	\$123.61	\$74.71
 Arrow® and Schlage® Packages Combined	20200H1 (P)	\$138.30	\$78.97	\$90.70	\$143.21	\$94.31
	20200H1 (S)	\$125.30	\$72.06	\$77.70	\$130.21	\$81.31
 6 Pin Cylinder for Arrow® “MK” Series (Except Ball) Original Cylinder Spacer must be replaced with Medeco Cylinder Spacer CP-160321	2020070 (P)	\$130.00	\$70.67	\$82.40	\$134.91	\$86.01
	2020070 (S)	\$117.00	\$63.77	\$69.40	\$121.91	\$73.01
 6 Pin Cylinder for Arrow RK Series	2020071 (P)	\$130.00	\$70.67	\$82.40	\$134.91	\$86.01
	2020071 (S)	\$117.00	\$63.77	\$69.40	\$121.91	\$73.01
 6 Pin Cylinder for Arrow® “MK” Series (B Knob Only) & GL Series Levers	2020073 (P)	\$130.00	\$70.67	\$82.40	\$134.91	\$86.01
	2020073 (S)	\$117.00	\$63.77	\$69.40	\$121.91	\$73.01
 6 Pin Cylinder for Arrow® “H”, “S”, & “HK” Knob Series, “Q”, “L” Series Lever	2020249 (P)	\$130.00	\$70.67	\$82.40	\$134.91	\$86.01
	2020249 (S)	\$117.00	\$63.77	\$69.40	\$121.91	\$73.01
 6 pin cylinder for Arrow “QL” and “MLX” Series Levers	2020049 (P)	\$130.00	\$70.67	\$82.40	\$134.91	\$86.01
	2020049 (S)	\$117.00	\$63.77	\$69.40	\$121.91	\$73.01
 6 Pin Cylinder for Arrow® “M” Series (Tulip or Tudor) Knobs	208008 (P)	\$130.00	\$70.67	\$82.40	\$134.91	\$86.01
	208008 (S)	\$117.00	\$63.77	\$69.40	\$121.91	\$73.01
 6 Pin Cylinder for Arrow® “RL” Series Levers	2080700 (P)	\$130.00	\$70.67	\$82.40	\$134.91	\$86.01
	2080700 (S)	\$117.00	\$63.77	\$69.40	\$121.91	\$73.01

\*\*Refer to the eCylinder section for more detail on specific technologies available and pricing. Technologies are represented by the following letters:  
T = Medeco<sup>3</sup>, S = M<sup>3</sup> CLIQ, J = Medeco<sup>3</sup> BiLevel, W = Biaxial, V = Medeco Biaxial CLIQ, K = Medeco KM, N = Medeco X4, C = Classic CLIQ, M = Medeco X4 CLIQ,  
“.” = Original, Z = Medeco Original KW CLIQ, G = Medeco XT \*\*\*See key section for surcharges for custom coined cut keys or special stamping requirements.  
**Note:** (P) refers to **Pinned** and (S) to **Sub-Assembled** at the end of each part string in the price book.

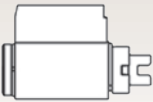
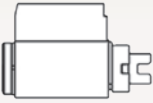
## Baldwin® Cylinders

Description	Part Number	M <sup>3</sup>	BiLevel	X4	Biax/Orig	KeyMark
 5 Pin Cylinder for Baldwin® for 5245, 5250, 5255 Levers & 5215, 5225 Knobs	2001300 (P)	\$130.00	\$70.67		\$134.91	
	2001300 (S)	\$117.00	\$63.77		\$121.91	
 5 Pin Cylinder for Baldwin® for 5205, 5210 Knobs & 5270, 5280 Levers, (Not available in Original Technology)	2001200 (P)	\$130.00	\$70.67		\$134.91	
	2001200 (S)	\$117.00	\$63.77		\$121.91	

## Cal-Royal Cylinders

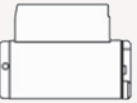
Description	Part Number	M <sup>3</sup>	BiLevel	X4	Biax/Orig	KeyMark
 6 Pin Cylinder for Cal-Royal SL00 Knob Lock and LX01 Lever Lock	2020049 (P)	\$130.00	\$70.67	\$82.40	\$134.91	\$86.01
	2020049 (S)	\$117.00	\$63.77	\$69.40	\$121.91	\$73.01
 6 Pin Cylinder for Cal-Royal CLS03 Classroom Function Grade 2 Lever Lock	20200V1 (P)	\$130.00	\$70.67	\$82.40	\$134.91	\$86.01
	20200V1 (S)	\$117.00	\$63.77	\$69.40	\$121.91	\$73.01
 6 Pin Cylinder for K200, L100, LX100, L200, LX200, Levers	20200S1(P)	\$131.70	\$72.36	\$84.10	\$136.61	\$87.71
	20200S1(S)	\$118.70	\$65.47	\$71.10	\$123.61	\$74.71



\*\*Refer to the eCylinder section for more detail on specific technologies available and pricing. Technologies are represented by the following letters:  
T = Medeco<sup>3</sup>, S = M<sup>3</sup> CLIQ, J = Medeco<sup>3</sup> BiLevel, W = Biaxial, V = Medeco Biaxial CLIQ, K = Medeco KM, N = Medeco X4, C = Classic CLIQ, M = Medeco X4 CLIQ,  
“-” = Original, Z = Medeco Original KW CLIQ, G = Medeco XT \*\*\*See key section for surcharges for custom coined cut keys or special stamping requirements.  
**Note:** (P) refers to **Pinned** and (S) to **Sub-Assembled** at the end of each part string in the price book.

## Corbin Russwin® Cylinders



Description	Part Number	M <sup>3</sup>	BiLevel	X4	Biax/Orig	KeyMark
 6 Pin Cylinder for Corbin Russwin® CL3900	20200V9 (P)	\$130.00	\$70.67	\$82.40	\$134.91	\$86.01
	20200V9 (S)	\$117.00	\$63.77	\$69.40	\$121.91	\$73.01
 6 Pin Cylinder for Corbin Russwin® old style 3300 & 3400 Series	2020575 (P)	\$130.00	\$70.67	\$82.40	\$134.91	\$86.01
	2020575 (S)	\$117.00	\$63.77	\$69.40	\$121.91	\$73.01
 6 Pin Cylinder for Corbin Russwin® 6600 Old Series, CK3400, CK4400 Knob	2020777 (P)	\$130.00	\$70.67	\$82.40	\$134.91	\$86.01
	2020777 (S)	\$117.00	\$63.77	\$69.40	\$121.91	\$73.01
 6 Pin Cylinder for Corbin Russwin® 800, CL3300, CL3400, CL3500, CL3600	20211730 (P)	\$130.00	\$70.67	\$82.40	\$134.91	\$86.01
	20211730 (S)	\$117.00	\$63.77	\$69.40	\$121.91	\$73.01
 5 Pin Cylinder for Corbin Russwin® Knob (Old Style)	205003 (P)	\$131.00	\$71.21	\$83.40	\$135.96	\$87.06
	205003 (S)	\$118.00	\$64.31	\$70.40	\$122.96	\$74.06
 6 Pin Cylinder for Corbin Russwin® 5460A, 5460E (Old Style), 46 F97, 46 F29, 83 F05	205004 (P)	\$130.00	\$70.67	\$82.40	\$134.91	\$86.01
	205004 (S)	\$117.00	\$63.77	\$69.40	\$121.91	\$73.01
 6 Pin Cylinder for Corbin Russwin® CK 4200 (New Style) UT5251	205005 (P)	\$130.00	\$70.67	\$82.40	\$134.91	\$86.01
	205005 (S)	\$117.00	\$63.77	\$69.40	\$121.91	\$73.01
 6 Pin Cylinder for Corbin Russwin® 5460 B, C, D, G, M (Old Style)	205006 (P)	\$130.00	\$70.67	\$82.40	\$134.91	\$86.01
	205006 (S)	\$117.00	\$63.77	\$69.40	\$121.91	\$73.01
 5 Pin Cylinder for Corbin Russwin® 5600 Series Signet® & Ensign®	205008 (P)	\$130.00		\$82.40	\$134.91	\$86.01
	205008(S)	\$117.00		\$69.40	\$121.91	\$73.01

\*\*Refer to the eCylinder section for more detail on specific technologies available and pricing. Technologies are represented by the following letters:  
T = Medeco<sup>3</sup>, S = M<sup>3</sup> CLIQ, J = Medeco<sup>3</sup> BiLevel, W = Biaxial, V = Medeco Biaxial CLIQ, K = Medeco KM, N = Medeco X4, C = Classic CLIQ, M = Medeco X4 CLIQ,  
“-” = Original, Z = Medeco Original KW CLIQ, G = Medeco XT \*\*\*See key section for surcharges for custom coined cut keys or special stamping requirements.  
**Note:** (P) refers to **Pinned** and (S) to **Sub-Assembled** at the end of each part string in the price book.

## Dorma® Cylinders

Description	Part Number	M <sup>3</sup>	BiLevel	X4	Biax/Orig	KeyMark
 6 Pin Cylinder for Dorma® CL700 Series Grade 2 Levers	2020049 (P)	\$130.00	\$70.67	\$82.40	\$134.91	\$86.01
	2020049 (S)	\$117.00	\$63.77	\$69.40	\$121.91	\$73.01
 6 Pin Cylinder for Dorma® CL860 (Interior), CL870, CL872, CL873, CL877 Grade 1 Lever, CK860 (Interior), CK870, CK872, CK873, & CK877 Grade 1 Knobs	20200V0 (P)	\$130.00	\$70.67	\$82.40	\$134.91	\$86.01
	20200V0 (S)	\$117.00	\$63.77	\$69.40	\$121.91	\$73.01
 6 Pin Cylinder for Dorma® CL853, CL860 (exterior), CL880, CL882, CL80EL, CL80EU Grade 1 Lever, CK853, CK860 (exterior), CK880, CK882, CK80EL, & CK80EU Grade 1 Knobs	20200V1 (P)	\$130.00	\$70.67	\$82.40	\$134.91	\$86.01
	20200V1 (S)	\$117.00	\$63.77	\$69.40	\$121.91	\$73.01

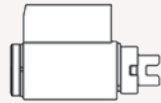





## Emtek® Cylinders

Description	Part Number	M <sup>3</sup>	BiLevel	X4	Biax/Orig	KeyMark
 5 Pin Cylinder for Emtek® Knobs	2051100 (P)	\$130.00	\$70.67		\$134.91	
	2051100 (S)	\$117.00	\$63.77		\$121.91	
 5 Pin Cylinder for Emtek® Levers, Except Hanover and Helios	2051200 (P)	\$130.00	\$70.67		\$134.91	
	2051200 (S)	\$117.00	\$63.77		\$121.91	
 5 Pin Cylinder for Emtek Hanover and Helios Levers	2052000 (P)	\$130.00	\$70.67		\$134.91	
	2052000 (S)	\$117.00	\$63.77		\$121.91	

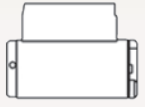
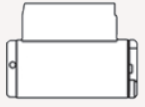
\*\*Refer to the eCylinder section for more detail on specific technologies available and pricing. Technologies are represented by the following letters:  
T = Medeco<sup>3</sup>, S = M<sup>3</sup> CLIQ, J = Medeco<sup>3</sup> BiLevel, W = Biaxial, V = Medeco Biaxial CLIQ, K = Medeco KM, N = Medeco X4, C = Classic CLIQ, M = Medeco X4 CLIQ,  
“-” = Original, Z = Medeco Original KW CLIQ, G = Medeco XT \*\*\*See key section for surcharges for custom coined cut keys or special stamping requirements.  
**Note:** (P) refers to **Pinned** and (S) to **Sub-Assembled** at the end of each part string in the price book.

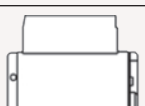

## Falcon® Cylinders

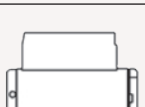
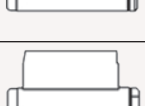

Description	Part Number	M <sup>3</sup>	BiLevel	X4	Biax/Orig	KeyMark
 6 Pin Cylinder for Falcon® Single Cylinder Deadbolt Lock (New Style)	200903 (P)	\$131.00	\$71.21	\$83.40	\$135.96	\$87.06
	200903 (S)	\$118.00	\$64.31	\$70.40	\$122.96	\$74.06
 6 Pin Cylinder for Falcon® "B" Series	2020049 (P)	\$130.00	\$70.67	\$82.40	\$134.91	\$86.01
	2020049 (S)	\$117.00	\$63.77	\$69.40	\$121.91	\$73.01
 6 Pin Cylinder for Falcon® F521, F561, F581 and "N" Series Knobs	2020051 (P)	\$130.00	\$70.67	\$82.40	\$134.91	\$86.01
	2020051 (S)	\$117.00	\$63.77	\$69.40	\$121.91	\$73.01
 6 Pin Cylinder for Falcon® "S" Series (Except "H" Knob)	2020054 (P)			\$82.40		\$86.01
	2020054 (S)			\$69.40		\$73.01
 6 Pin Cylinder for Falcon® "S" Series ("H" Knob Only)	2020058 (P)			\$82.40		\$86.01
	2020058 (S)			\$69.40		\$73.01
 6 Pin Cylinder for Falcon® "X" Series (Except "H" Knob)	2020068(P)	\$130.00	\$70.67	\$82.40	\$134.91	\$86.01
	2020068(S)	\$117.00	\$63.77	\$69.40	\$121.91	\$73.01
 6 Pin Cylinder for Falcon® "X" Series ("H" Knobs Only) Original Cylinder Spacer must be replaced with Medeco Cylinder Spacer CP-160321	2020071 (P)	\$130.00	\$70.67	\$82.40	\$134.91	\$86.01
	2020071 (S)	\$117.00	\$63.77	\$69.40	\$121.91	\$73.01
 6 Pin Cylinder for Falcon® "LY" Lever	2020072 (P)	\$130.00	\$70.67	\$82.40	\$134.91	\$86.01
	2020072 (S)	\$117.00	\$63.77	\$69.40	\$121.91	\$73.01
 6 Pin Cylinder for Falcon® Inside Cylinder T-381	2020073 (P)	\$130.00	\$70.67	\$82.40	\$134.91	\$86.01
	2020073 (S)	\$117.00	\$63.77	\$69.40	\$121.91	\$73.01
 6 Pin Cylinder for Falcon® "B", "LY", "X", "S", & "T" series includes: CT-Y49, CT-Y54, CT-Y58, CT-Y68, CT-Y71, CT-Y72, CT-V03, CP-160311	20200F1 (P)	\$131.70	\$72.36	\$84.10	\$136.61	\$87.71
	20200F1 (S)	\$118.70	\$65.47	\$71.10	\$123.61	\$74.71
 6 Pin Cylinder for Falcon® "RU" Series and T381 Outside Cylinder	20200V3 (P)	\$130.00	\$70.67	\$82.40	\$134.91	\$86.01
	20200V3 (S)	\$117.00	\$63.77	\$69.40	\$121.91	\$73.01

\*\*Refer to the eCylinder section for more detail on specific technologies available and pricing. Technologies are represented by the following letters:  
T = Medeco<sup>3</sup>, S = M<sup>3</sup> CLIQ, J = Medeco<sup>3</sup> BiLevel, W = Biaxial, V = Medeco Biaxial CLIQ, K = Medeco KM, N = Medeco X4, C = Classic CLIQ, M = Medeco X4 CLIQ,  
"." = Original, Z = Medeco Original KW CLIQ, G = Medeco XT \*\*\*See key section for surcharges for custom coined cut keys or special stamping requirements.  
**Note:** (P) refers to **Pinned** and (S) to **Sub-Assembled** at the end of each part string in the price book.



## Hager® Cylinders

Description	Part Number	M <sup>3</sup>	BiLevel	X4	Biax/Orig	KeyMark
 6 Pin Cylinder for Hager® Lever Locksets, 3500 Series	2020249 (P)	\$130.00	\$70.67	\$82.40	\$134.91	\$86.01
	2020249 (S)	\$117.00	\$63.77	\$69.40	\$121.91	\$73.01





## KABA® Mas-Hamilton Cylinders

Description	Part Number	M <sup>3</sup>	BiLevel	X4	Biax/Orig	KeyMark
 MAS-Hamilton® Power Lever	20200V1 (P)	\$130.00	\$70.67	\$82.40	\$134.91	\$86.01
	20200V1 (S)	\$117.00	\$63.77	\$69.40	\$121.91	\$73.01
 6 pin cylinder for Kaba E-plex 2000 (18 bow key req. for Orig/Biax)	2051500 (P)	\$130.00	\$70.67	\$82.40	\$134.91	\$86.01
	2051500 (S)	\$117.00	\$63.77	\$69.40	\$121.91	\$73.01

## Lockwood® Cylinders



Description	Part Number	M <sup>3</sup>	BiLevel	X4	Biax/Orig	KeyMark
 5 Pin Cylinder for Lockwood® 530	201006 (P)	\$130.00				
	201006 (S)	\$117.00				
 6 Pin Cylinder for Lockwood®	2020169 (P)	\$130.00	\$70.67	\$82.40	\$134.91	\$86.01
	2020169 (S)	\$117.00	\$63.77	\$69.40	\$121.91	\$73.01

## LSDA® Cylinders

Description	Part Number	M <sup>3</sup>	BiLevel	X4	Biax/Orig	KeyMark
 6 Pin cylinder for LSDA® 100 Series Knob (Except "B" Knob), L100 Series Lever	2020070 (P)	\$130.00	\$70.67	\$82.40	\$134.91	\$86.01
	2020070 (S)	\$117.00	\$63.77	\$69.40	\$121.91	\$73.01
 6 Pin Cylinder for LSDA® 100 (B Knob Only)	2020073 (P)	\$130.00	\$70.67	\$82.40	\$134.91	\$86.01
	2020073 (S)	\$117.00	\$63.77	\$69.40	\$121.91	\$73.01
 6 Pin Cylinder for LSDA® LX1000 Lever	2020078 (P)	\$130.00	\$70.67	\$82.40	\$134.91	\$86.01
	2020078 (S)	\$117.00	\$63.77	\$69.40	\$121.91	\$73.01
 6 Pin cylinder package for LSDA® 100, L100, LH1000, LX1000 Series. Includes: CT-Y49, CTY70, CT-Y73, CT-Y78	20200L1 (P)	\$131.70	\$72.36	\$84.10	\$136.61	\$87.71
	20200L1 (S)	\$118.70	\$65.47	\$71.10	\$123.61	\$74.71

\*\*Refer to the eCylinder section for more detail on specific technologies available and pricing. Technologies are represented by the following letters:  
T = Medeco<sup>3</sup>, S = M<sup>3</sup> CLIQ, J = Medeco<sup>3</sup> BiLevel, W = Biaxial, V = Medeco Biaxial CLIQ, K = Medeco KM, N = Medeco X4, C = Classic CLIQ, M = Medeco X4 CLIQ,  
“-” = Original, Z = Medeco Original KW CLIQ, G = Medeco XT \*\*\*See key section for surcharges for custom coined cut keys or special stamping requirements.  
**Note:** (P) refers to **Pinned** and (S) to **Sub-Assembled** at the end of each part string in the price book.

**Marks® Cylinders**

Description	Part Number	M <sup>3</sup>	BiLevel	X4	Biax/Orig	KeyMark
 6 Pin Cylinder for Marks® 110, 170, 180, 190, 195, 295 Series DA-Vestibule, DC & SB Communicating, S-Classroom & Classroom Security Functions	20200V0 (P)	\$130.00	\$70.67	\$82.40	\$134.91	\$86.01
	20200V0 (S)	\$117.00	\$63.77	\$69.40	\$121.91	\$73.01
 6 pin Cylinder for Marks 110, 170, 180, 190, 195, 295 Series in AB-Entrance, DW Institution, F-Storeroom, & T Corridor Functions	20200V1 (P)	\$130.00	\$70.67	\$82.40	\$134.91	\$86.01
	20200V1 (S)	\$117.00	\$63.77	\$69.40	\$121.91	\$73.01

**Marvin® Cylinders**

Description	Part Number	M <sup>3</sup>	BiLevel	X4	Biax/Orig	KeyMark
 5 Pin Cylinder for Marvin® Auxiliary Locks	2000827 (P)	\$130.00	\$70.67		\$134.91	
	2000827 (S)	\$117.00	\$63.77		\$121.91	

**Medeco Embassy® Cylinders**

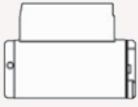
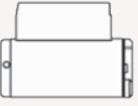
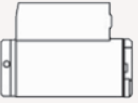

Description	Part Number	M <sup>3</sup>	BiLevel	X4	Biax/Orig	KeyMark
 6 Pin Cylinder for Embassy® Vestibule, Communicating, Classroom & Classroom Security Functions. For Embassy Levers sold thru 9/06 & ALL Knobs	20200V0 (P)	\$130.00	\$70.67	\$82.40	\$134.91	\$86.01
	20200V0 (S)	\$117.00	\$63.77	\$69.40	\$121.91	\$73.01
 6 Pin Cylinder for Embassy® in Entrance, Institution, Storeroom, Corridor Functions. For Embassy Levers sold thru 9/06 & ALL Knobs	20200V1 (P)	\$130.00	\$70.67	\$82.40	\$134.91	\$86.01
	20200V1 (S)	\$117.00	\$63.77	\$69.40	\$121.91	\$73.01
 6 Pin Cylinder for Embassy Levers All Functions after 9/2006	2020249 (P)	\$130.00	\$70.67	\$82.40	\$134.91	\$86.01
	2020249 (S)	\$117.00	\$63.77	\$69.40	\$121.91	\$73.01

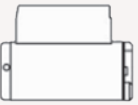
**Olympus® Cylinders**

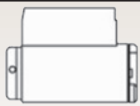

Description	Part Number	M <sup>3</sup>	BiLevel	X4	Biax/Orig	KeyMark
 6 Pin Cylinder for Olympus® 700LCM, 800LCM Non-key Retaining Cabinet Lock Includes: CT-F34-CT-F38	20009S4 (P)	\$134.50	\$75.17	\$86.90	\$139.41	\$90.51
	20009S4 (S)	\$121.50	\$68.27	\$73.90	\$126.41	\$77.51
 6 Pin Cylinder for Olympus® 700LCM, 800LCM Key Retaining Cabinet lock, Includes: CT-Y49, CT-Y52, CT-Y53, CT-Y54	20200S1 (P)	\$131.70	\$72.36	\$84.10	\$136.61	\$87.71
	20200S1 (S)	\$118.70	\$65.47	\$71.10	\$123.61	\$74.71

\*\*Refer to the eCylinder section for more detail on specific technologies available and pricing. Technologies are represented by the following letters:  
T = Medeco<sup>3</sup>, S = M<sup>3</sup> CLIQ, J = Medeco<sup>3</sup> BiLevel, W = Biaxial, V = Medeco Biaxial CLIQ, K = Medeco KM, N = Medeco X4, C = Classic CLIQ, M = Medeco X4 CLIQ,  
“-” = Original, Z = Medeco Original KW CLIQ, G = Medeco XT \*\*\*See key section for surcharges for custom coined cut keys or special stamping requirements.  
**Note:** (P) refers to **Pinned** and (S) to **Sub-Assembled** at the end of each part string in the price book.



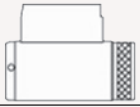

## PDQ® Cylinders

Description	Part Number	M <sup>3</sup>	BiLevel	X4	Biax/Orig	KeyMark
 6 Pin Cylinder for PDQ® "SX" Series	2020149 (P)	\$130.00	\$70.67		\$134.91	
	2020149 (S)	\$117.00	\$63.77		\$121.91	
 6 Pin Cylinder for PDQ® "SV" Knob/Lever	203000 (P)	\$130.00	\$70.67	\$82.40	\$134.91	\$86.01
	203000 (S)	\$117.00	\$63.77	\$69.40	\$121.91	\$73.01
 6 Pin cylinder for PDQ® Lever SP & ST Series, GT, XGT & GP Series	20200V2 (P)	\$130.00	\$70.67	\$82.40	\$134.91	\$86.01
	20200V2 (S)	\$117.00	\$63.77	\$69.40	\$121.91	\$73.01

## Pella® Cylinders

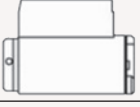
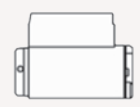
Description	Part Number	M <sup>3</sup>	BiLevel	X4	Biax/Orig	KeyMark
 5 Pin Knob cylinder to fit popular Pella storm and patio doors	2000827 (P)	\$130.00	\$70.67		\$134.91	
	2000827 (S)	\$117.00	\$63.77		\$121.91	
 5 Pin profile type cylinder to fit popular Pella and Anderson storm and patio doors	490258 (P)	\$165.00			\$171.38	
	490258 (S)	\$152.00			\$158.38	

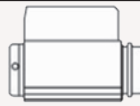
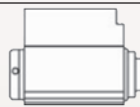
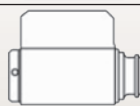
## Sargent® Cylinders

Description	Part Number	M <sup>3</sup>	BiLevel	X4	Biax/Orig	KeyMark
 6 Pin Cylinder for Sargent® 6 Line (Except for B Knob) & 6500 Lever - For Original Design, otherwise use 20*80147	2020170 (P)	\$130.00	\$70.67	\$82.40	\$134.91	\$86.01
	2020170 (S)	\$117.00	\$63.77	\$69.40	\$121.91	\$73.01
 6 Pin cylinder for Sargent® 6 Line (B Knob Only) Original Cylinder Spacer must be replaced with Medeco Cylinder Spacer CP-160321 (Included) - For Original Design, otherwise use 20*80147	2020173 (P)	\$130.00	\$130.00	\$82.40	\$134.91	\$86.01
	2020173 (S)	\$117.00	\$63.77	\$69.40	\$121.91	\$73.01
 6 Pin Cylinder for Sargent® 10 Line, Levers 7L & 8L - For Original Design, otherwise use 20*80147	2020349 (P)	\$130.00	\$70.67	\$82.40	\$134.91	\$86.01
	2020349 (S)	\$117.00	\$63.77	\$69.40	\$121.91	\$73.01
 6 Pin Cylinder for Sargent® 7600 Integra®	208005 (P)	\$130.00	\$70.67	\$82.40	\$134.91	\$86.01
	208005 (S)	\$117.00	\$63.77	\$69.40	\$121.91	\$73.01
 6 Pin Cylinder for Sargent® 8 & 9 Line knobs	208006 (P)	\$130.00	\$70.67	\$82.40	\$134.91	\$86.01
	208006 (S)	\$117.00	\$63.77	\$69.40	\$121.91	\$73.01
 5 Pin Cylinder for Sargent® 6 Line Includes: CT-Y35, CT-Y37, CT-Y47, CT-Y55	208007 (P)	\$130.00	\$70.67	\$82.40	\$134.91	\$86.01
	208007 (S)	\$117.00	\$63.77	\$69.40	\$121.91	\$73.01
 6 Pin Cylinder for Sargent® 6, 7, & 10 line, 6500 Series (Not Available in Original Technology) Includes: CT-Y35- CT-Y37- CTY47 & CT-Y55	2080147 (P)	\$131.00	\$71.21	\$83.40	\$135.96	\$87.06
	2080147 (S)	\$118.00	\$64.31	\$70.40	\$122.96	\$74.06
 6 Pin Cylinder for Sargent® 11 Line (Not Available in Original Technology)	2080148 (P)	\$131.00	\$71.21		\$135.96	
	2080148 (S)	\$118.00	\$64.31		\$122.96	

\*\*Refer to the eCylinder section for more detail on specific technologies available and pricing. Technologies are represented by the following letters: T = Medeco<sup>3</sup>, S = M<sup>3</sup> CLIQ, J = Medeco<sup>3</sup> BiLevel, W = Biaxial, V = Medeco Biaxial CLIQ, K = Medeco KM, N = Medeco X4, C = Classic CLIQ, M = Medeco X4 CLIQ, "." = Original, Z = Medeco Original KW CLIQ, G = Medeco XT \*\*\*See key section for surcharges for custom coined cut keys or special stamping requirements.



**Note:** (P) refers to Pinned and (S) to Sub-Assembled at the end of each part string in the price book.

## Schlage® Cylinders

Description	Part Number	M <sup>3</sup>	BiLevel	X4	Biax/Orig	KeyMark
 5 Pin Knob Cylinder for Schlage® "F" Series Plymouth & Ball Knob (Mfg prior to 2004)	2000400 (P)	\$130.00	\$70.67		\$134.91	
	2000400 (S)	\$117.00	\$63.77		\$121.91	
 6 Pin Cylinder for Schlage® "F" Series Orbit Design Only (Manufactured Prior to 2004)	2000700 (P)	\$130.00	\$70.67	\$82.40	\$134.91	\$86.01
	2000700 (S)	\$117.00	\$63.77	\$69.40	\$121.91	\$73.01
 5 Pin Cylinder for Schlage® "F" Series Lever (Manufactured Prior to 2004)	2001400 (P)	\$130.00	\$70.67		\$134.91	
	2001400 (S)	\$117.00	\$63.77		\$121.91	
 5 Pin Cylinder for Schlage® "F" Series Lever (Manufactured 2004 through 2007)	2001700 (P)	\$130.00	\$70.67		\$134.91	
	2001700 (S)	\$117.00	\$63.77		\$121.91	
 5 Pin Knob Cylinder for Schlage® "A" Series (Ply Only)	200700 (P)	\$130.00	\$70.67		\$134.91	
	200700 (S)	\$117.00	\$63.77		\$121.91	
 5 Pin Knob Cylinder for Schlage® "A" Series (Except Ply)	200701 (P)	\$130.00	\$70.67		\$134.91	
	200701 (S)	\$117.00	\$63.77		\$121.91	
 6 Pin Cylinder for Schlage® "A", "AL", & "D", Series Olympiad® Lever (Use CT-Y73, for "AL" thick doors)	2020049 (P)	\$130.00	\$70.67	\$82.40	\$134.91	\$86.01
	2020049 (S)	\$117.00	\$63.77	\$69.40	\$121.91	\$73.01
 6 Pin Cylinder for Schlage® "C, D" Series (Ply Only)	2020051 (P)	\$130.00	\$70.67	\$82.40	\$134.91	\$86.01
	2020051 (S)	\$117.00	\$63.77	\$69.40	\$121.91	\$73.01
 6 Pin Cylinder for Schlage® "C", & "D" Series Heavy Duty Knobs Ball, Globe & Sphere Designs Only	2020052 (P)	\$130.00	\$70.67	\$82.40	\$134.91	\$86.01
	2020052 (S)	\$117.00	\$63.77	\$69.40	\$121.91	\$73.01
 6 Pin Cylinder for Schlage® "A" Series (Orbit® Only)	2020053 (P)	\$130.00	\$70.67	\$82.40	\$134.91	\$86.01
	2020053 (S)	\$117.00	\$63.77	\$69.40	\$121.91	\$73.01
 6 Pin Knob Cylinder for Schlage® "ND" & "AL" Series Grade 1 Lever. **See note	2020073 (P)	\$130.00	\$70.67	\$82.40	\$134.91	\$86.01
	2020073 (S)	\$117.00	\$63.77	\$69.40	\$121.91	\$73.01
 6 Pin Knob Cylinder for Schlage® "S" Series	2020097 (P)	\$131.70	\$72.36	\$84.10	\$136.61	\$87.71
	2020097 (S)	\$118.70	\$65.47	\$71.10	\$123.61	\$74.71
 6 Pin Knob Cylinder Assembly for Schlage® & Arrow® (Except Arrow "H" & "S" Series) Includes: CT-Y49, CT-Y52, CTY53, CT-Y70, CT-Y73, CT-Y74, CP-160321 **See note	20200H1 (P)	\$138.30	\$78.97	\$90.70	\$143.21	\$94.31
	20200H1 (S)	\$125.30	\$72.06	\$77.70	\$130.21	\$81.31

\*\*Refer to the eCylinder section for more detail on specific technologies available and pricing. Technologies are represented by the following letters:  
T = Medeco<sup>3</sup>, S = M<sup>3</sup> CLIQ, J = Medeco<sup>3</sup> BiLevel, W = Biaxial, V = Medeco Biaxial CLIQ, K = Medeco KM, N = Medeco X4, C = Classic CLIQ, M = Medeco X4 CLIQ,  
"." = Original, Z = Medeco Original KW CLIQ, G = Medeco XT \*\*\*See key section for surcharges for custom coined cut keys or special stamping requirements.  
**Note:** (P) refers to **Pinned** and (S) to **Sub-Assembled** at the end of each part string in the price book.

## Schlage® Cylinders





Description	Part Number	M <sup>3</sup>	BiLevel	X4	Biax/Orig	KeyMark
 6 Pin Cylinder Package for Schlage A, AL, C, D, ND & Olympiad lever designs, includes: CT-Y49 (A, AL, & D Olympiad Lever & C & D Plymouth), CT-Y52 (C & D heavy duty knobs Ball, Globe & Sphere designs only), CT-Y53 (A series Orbit), CT-Y73 (ND series Gr. 1 lever & AL thick doors), and CT-Y74 (45-101 padlock) (Use CT-Y73 for thick doors) ** See note	20200S1 (P)	\$131.70	\$72.36	\$84.10	\$136.61	\$87.71
	20200S1 (S)	\$118.70	\$65.47	\$71.10	\$123.61	\$74.71
 6 Pin Cylinder for Schlage D Series Lever, Athens, Rhodes & Sparta Designs	2020249 (P)	\$130.00	\$70.67	\$82.40	\$134.91	\$86.01
	2020249 (S)	\$117.00	\$63.77	\$69.40	\$121.91	\$73.01

\*\* The ND series with Sparta trim is not compatible with 17 bow (Biaxial large bow) keys. 12 bow (small bow) or 18 bow (large bow/extended throat) keys must be used instead.

## Taco® Cylinders

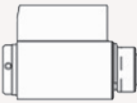
Description	Part Number	M <sup>3</sup>	BiLevel	X4	Biax/Orig	KeyMark
 6 Pin Cylinder TACO® LXV Lever Lockset	200500 (P)	\$130.00	\$70.67	\$82.40	\$134.91	\$86.01
	200500 (S)	\$117.00	\$63.77	\$69.40	\$121.91	\$73.01







## Yale® Cylinders

Description	Part Number	M <sup>3</sup>	BiLevel	X4	Biax/Orig	KeyMark
 6 Pin Cylinder for Yale® Knobs 5300, 5400, 6100, 6200	200500 (P)	\$130.00	\$70.67	\$82.40	\$134.91	\$86.01
	200500 (S)	\$117.00	\$63.77	\$69.40	\$121.91	\$73.01
 6 Pin Cylinder for Yale® 5300LN, 5400LN, 4300 series knobs	200503 (P)	\$130.00	\$70.67	\$82.40	\$134.91	\$86.01
	200503 (S)	\$117.00	\$63.77	\$69.40	\$121.91	\$73.01
 6 Pin cylinder for Yale® YMCL100, YMCL200	2020073 (P)	\$130.00	\$70.67	\$82.40	\$134.91	\$86.01
	2020073 (S)	\$117.00	\$63.77	\$69.40	\$121.91	\$73.01
 6 Pin cylinder for Yale® 4600LN	2080700 (P)	\$130.00	\$70.67	\$82.40	\$134.91	\$86.01
	2080700 (S)	\$117.00	\$63.77	\$69.40	\$121.91	\$73.01



\*\*Refer to the eCylinder section for more detail on specific technologies available and pricing. Technologies are represented by the following letters:  
 T = Medeco<sup>3</sup>, S = M<sup>3</sup> CLIQ, J = Medeco<sup>3</sup> BiLevel, W = Biaxial, V = Medeco Biaxial CLIQ, K = Medeco KM, N = Medeco X4, C = Classic CLIQ, M = Medeco X4 CLIQ,  
 “.” = Original, Z = Medeco Original KW CLIQ, G = Medeco XT \*\*\*See key section for surcharges for custom coined cut keys or special stamping requirements.  
**Note:** (P) refers to **Pinned** and (S) to **Sub-Assembled** at the end of each part string in the price book.



**Arrow® Deadbolt Cylinders**

Description	Part Number	M <sup>3</sup>	BiLevel	X4	Biax/Orig	KeyMark
 5 Pin Cylinder for Arrow JL Interconnected lock. Separate cylinder required for lever.	1065140 (P)	\$134.00	\$72.84	\$85.30	\$139.08	\$89.18
	1065140 (S)	\$121.00	\$65.94	\$72.30	\$126.08	\$76.18
 5 Pin Cylinder (6 Pin KeyMark) for Arrow D & E Series Single Cylinder Deadbolt	200801 (P)	\$131.00	\$71.21		\$135.96	
	200801 (S)	\$118.00	\$64.31		\$122.96	
 5 Pin Cylinder for Arrow D & E Series Double Cylinder Deadbolt	200802 (P)	\$128.00	\$69.58		\$132.83	
	200802 (S)	\$115.00	\$62.67		\$119.83	
 6 Pin Cylinder for Arrow D & E Series Single Cylinder Deadbolt	200901 (P)	\$131.00	\$71.21	\$83.40	\$135.96	\$87.06
	200901 (S)	\$118.00	\$64.31	\$70.40	\$122.96	\$74.06
 6 Pin Cylinder for Arrow D & E Series Double Cylinder Deadbolt	200902 (P)	\$131.00	\$71.21	\$83.40	\$135.96	\$87.06
	200902 (S)	\$118.00	\$64.31	\$70.40	\$122.96	\$74.06
 6 Pin Cylinder for Arrow Revolution Deadbolt*Order CT-Y27 tailpiece separately	200901 (P)	\$131.00	\$71.21	\$83.40	\$135.96	\$87.06
	200901 (S)	\$118.00	\$64.31	\$70.40	\$122.96	\$74.06

**Baldwin® Deadbolt Cylinders**

Description	Part Number	M <sup>3</sup>	BiLevel	X4	Biax/Orig	KeyMark
 5 Pin Rim Type Lazy Motion Single Cylinder handlesets and deadbolts	1075127 (P)	\$157.50	\$92.70	\$90.00	\$162.92	\$94.02
	1075127 (S)	\$144.50	\$85.81	\$77.00	\$149.92	\$81.02
 5 Pin Lazy Motion cylinder for Baldwin 2 point lock handleset (lower cylinder)	2001851 (P)	\$130.00	\$70.67		\$134.91	
	2001851 (S)	\$117.00	\$63.77		\$121.91	



**Cal-Royal® Deadbolt Cylinder**

Description	Part Number	M <sup>3</sup>	BiLevel	X4	Biax/Orig	KeyMark
 6 Pin Cylinder for Cal-Royal T-300 Series Grade 2 Deadbolt, Includes: CT-F34, DT-F35, CTF36, CT-F37 & CT-F38	2000954 (P)	\$134.50	\$75.17	\$86.90	\$139.41	\$90.51
	2000954 (S)	\$121.50	\$68.27	\$73.90	\$126.41	\$77.51

**Corbin Russwin® Deadbolt Cylinder**

Description	Part Number	M <sup>3</sup>	BiLevel	X4	Biax/Orig	KeyMark
 6 Pin Cylinder for Corbin Russwin DL2100, DL3100 Deadbolt	2051027 (P)	\$130.00	\$70.67	\$82.40	\$134.91	\$86.01
	2051027 (S)	\$117.00	\$63.77	\$69.40	\$121.91	\$73.01

**Emtek® Deadbolt Cylinders**

Description	Part Number	M <sup>3</sup>	BiLevel	X4	Biax/Orig	KeyMark
 5 Pin Rim Lazy Motion Rim Type Cylinder to fit Emtek® Handleset & Deadbolt Outside Cylinder	1065140 (P)	\$134.00	\$72.84	\$85.30	\$139.08	\$89.18
	1065140 (S)	\$121.00	\$65.94	\$72.30	\$126.08	\$76.18
 5 Pin Rim Lazy Motion Rim Type Cylinder To Inside Cylinder w/Emtek Tailpiece	1065244 (P)	\$142.00	\$77.20		\$147.42	
	1065244 (S)	\$129.00	\$70.31		\$134.42	

\*\*Refer to the eCylinder section for more detail on specific technologies available and pricing. Technologies are represented by the following letters: T = Medeco<sup>3</sup>, S = M<sup>3</sup> CLIQ, J = Medeco<sup>3</sup> BiLevel, W = Biaxial, V = Medeco Biaxial CLIQ, K = Medeco KM, N = Medeco X4, C = Classic CLIQ, M = Medeco X4 CLIQ, " " = Original, Z = Medeco Original KW CLIQ, G = Medeco XT \*\*\*See key section for surcharges for custom coined cut keys or special stamping requirements.

**Note:** (P) refers to **Pinned** and (S) to **Sub-Assembled** at the end of each part string in the price book.

## Falcon® Deadbolt Cylinders

Description	Part Number	M <sup>3</sup>	BiLevel	X4	Biax/Orig	KeyMark
6 Pin Cylinder for Falcon Single Cylinder Deadbolt Lock (New Style)	200903 (P)	\$131.00	\$71.21	\$83.40	\$135.96	\$87.06
	200903 (S)	\$118.00	\$64.31	\$70.40	\$122.96	\$74.06
5 Pin Cylinder for Falcon Single Cylinder Deadbolt Lock (Old Style)	206005 (P)	\$131.00	\$71.21		\$135.96	
	206005 (S)	\$118.00	\$64.31		\$122.96	
5 Pin Cylinder for Falcon Double Cylinder Deadbolt Lock (Old Style)	206100 (P)	\$130.00	\$70.67		\$134.91	
	206100 (S)	\$117.00	\$63.77		\$121.91	

## Kwikset® Deadbolt Cylinders

Description	Part Number	M <sup>3</sup>	BiLevel	X4	Biax/Orig	KeyMark
6 Pin Lazy Motion Rim Type for Kwikset® Single Cylinder deadbolts, except Powerbolt	1012040 (P)	\$138.00	\$75.03		\$143.25	
	1012040 (S)	\$125.00	\$68.13		\$130.25	

## PDQ® Deadbolt Cylinder









Description	Part Number	M <sup>3</sup>	BiLevel	X4	Biax/Orig	KeyMark
6 Pin Cylinder for PDQ KV Series Deadbolt	200903 (P)	\$131.00	\$71.21	\$83.40	\$135.96	\$87.06
	200903 (S)	\$118.00	\$64.31	\$70.40	\$122.96	\$74.06

## Sargent® Deadbolt Cylinder

Description	Part Number	M <sup>3</sup>	BiLevel	X4	Biax/Orig	KeyMark
6 Pin Cylinder for 470 & 480 Single Cylinder Deadbolt Lock	200901 (P)	\$131.00	\$71.21	\$83.40	\$135.96	\$87.06
	200901 (S)	\$118.00	\$64.31	\$70.40	\$122.96	\$74.06
6 Pin Cylinder for Sargent 470 & 480 Double Cylinder Deadbolt Lock	200902 (P)	\$131.00	\$71.21	\$83.40	\$135.96	\$87.06
	200902 (S)	\$118.00	\$64.31	\$70.40	\$122.96	\$74.06
5 Pin Cylinder for Sargent 470 & 480 Single Cylinder Deadbolt	200801 (P)	\$131.00	\$71.21		\$135.96	
	200801 (S)	\$118.00	\$64.31		\$122.96	
5 Pin Cylinder for Sargent 470 & 480 Double Cylinder Deadbolt	200802 (P)	\$128.00	\$69.58		\$132.83	
	200802 (S)	\$115.00	\$62.67		\$119.83	
5 Pin cylinder for Sargent 460 Single Cylinder deadbolt	200807 (P)	\$131.00	\$71.21		\$135.96	
	200807 (S)	\$118.00	\$64.31		\$122.96	
6 Pin cylinder for Sargent 460 Single Cylinder deadbolt	200907 (P)	\$131.00	\$71.21	\$83.40	\$135.96	\$87.06
	200907 (S)	\$118.00	\$64.31	\$70.40	\$122.96	\$74.06
5 Pin cylinder for Sargent 460 Double Cylinder deadbolt	200808 (P)	\$131.00	\$71.21		\$135.96	
	200808 (S)	\$118.00	\$64.31		\$122.96	
6 Pin cylinder for Sargent 460 Double Cylinder deadbolt	200908 (P)	\$131.00	\$71.21	\$83.40	\$135.96	\$87.06
	200908 (S)	\$118.00	\$64.31	\$70.40	\$122.96	\$74.06





\*\*Refer to the eCylinder section for more detail on specific technologies available and pricing. Technologies are represented by the following letters: T = Medeco<sup>3</sup>, S = M<sup>3</sup> CLIQ, J = Medeco<sup>3</sup> BiLevel, W = Biaxial, V = Medeco Biaxial CLIQ, K = Medeco KM, N = Medeco X4, C = Classic CLIQ, M = Medeco X4 CLIQ, “.” = Original, Z = Medeco Original KW CLIQ, G = Medeco XT \*\*\*See key section for surcharges for custom coined cut keys or special stamping requirements.  
**Note:** (P) refers to **Pinned** and (S) to **Sub-Assembled** at the end of each part string in the price book.

## Schlage® Deadbolt Cylinder

Description	Part Number	M <sup>3</sup>	BiLevel	X4	Biax/Orig	KeyMark
 5 Pin Lazy Motion Schlage® Outside Cylinder for "E", "H", B200, B400 Series Deadbolt (Rim Type Cylinder) includes CT-F34-CT-F38	10651S4 (P)	\$153.40	\$92.25	\$104.70	\$158.48	\$108.58
	10651S4 (S)	\$140.40	\$85.34	\$91.70	\$145.48	\$95.58
 5 Pin Lazy Motion Schlage® Inside Cylinder for B200/B400 Series Deadbolt Lock (Rim Type Cylinder) includes CT-F34-CTF38	10652S4 (P)	\$152.80	\$72.53	\$100.80	\$159.65	\$106.25
	10652S4 (S)	\$139.80	\$65.64	\$87.80	\$146.65	\$93.25
 6 Pin Lazy Motion Schlage® Outside Cylinder for "E", "H", B200, B400 Series Deadbolt Lock (Rim Type Cylinder) includes: CT-F34-CT-F38	10661S4 (P)	\$154.80	\$90.00	\$106.10	\$160.22	\$110.32
	10661S4 (S)	\$141.80	\$83.11	\$93.10	\$147.22	\$97.32
 6 Pin Lazy Motion Schlage® Inside Cylinder for B200 and B400 Series Deadbolt Lock (Rim Type Cylinder) includes: CT-F34-CT-F38	10662S4 (P)	\$152.80	\$72.53	\$100.80	\$159.65	\$106.25
	10662S4 (S)	\$139.80	\$65.64	\$87.80	\$146.65	\$93.25
 5 Pin Laz Motion Cylinder for Schlage B Series Deadbolt Lock (less tailpiece)	2000800 (P)	\$130.00	\$70.67		\$134.91	
	2000800 (S)	\$117.00	\$63.77		\$121.91	
 5 Pin Knob Cylinder for Schlage B, E, and F160 Series Deadbolt lock, includes CT-F34, CT-F38	20008S4 (P)	\$134.50	\$75.17		\$139.41	
	20008S4 (S)	\$121.50	\$68.27		\$126.41	
 6 Pin Lazy Motion Cylinder Schlage B Series (Old Style) deadbolt	200904 (P)	\$131.00	\$71.21	\$83.40	\$135.96	\$87.06
	200904 (S)	\$118.00	\$64.31	\$70.40	\$122.96	\$74.06
 6 Pin Lazy Motion Cylinder for Schlage B Series Deadbolt (less tailpiece) except B662 after 2001	2000900 (P)	\$130.00	\$70.67	\$82.40	\$134.91	\$86.01
	2000900 (S)	\$117.00	\$63.77	\$69.40	\$121.91	\$73.01
 6 Pin Lazy Motion Knob Cylinder for Schlage® "B", "E", and F160 includes: CT-F34, CTF35, CT-F36, CT-F37, CT-F38	20009S4 (P)	\$134.50	\$75.17	\$86.90	\$139.41	\$90.51
	20009S4 (S)	\$121.50	\$68.27	\$73.90	\$126.41	\$77.51

\*\*Refer to the eCylinder section for more detail on specific technologies available and pricing. Technologies are represented by the following letters:  
T = Medeco<sup>3</sup>, S = M<sup>3</sup> CLIQ, J = Medeco<sup>3</sup> BiLevel, W = Biaxial, V = Medeco Biaxial CLIQ, K = Medeco KM, N = Medeco X4, C = Classic CLIQ, M = Medeco X4 CLIQ,  
"." = Original, Z = Medeco Original KW CLIQ, G = Medeco XT \*\*\*See key section for surcharges for custom coined cut keys or special stamping requirements.  
**Note:** (P) refers to **Pinned** and (S) to **Sub-Assembled** at the end of each part string in the price book.

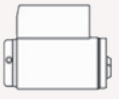
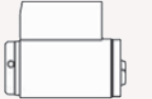
## Weiser® Deadbolt Cylinders

Description	Part Number	M <sup>3</sup>	BiLevel	X4	Biax/Orig	KeyMark
 5 Pin Lazy Motion Outside Cylinder for Weiser® Prestige Series Deadbolt and Entryset/ Handleset	100602 (P)	\$129.00	\$70.12	\$87.10	\$133.87	\$92.47
	100602 (S)	\$116.00	\$63.22	\$74.10	\$120.87	\$79.47
 6 Pin Lazy Motion Outside Cylinder for Weiser Prestige Entryset/Handleset	100702 (P)	\$134.00	\$72.84	\$90.40	\$139.08	\$94.18
	100702 (S)	\$121.00	\$65.94	\$77.40	\$126.08	\$81.18
 6 Pin Cylinder for Weiser® Single Cylinder Deadbolt, including powerbolt	200903 (P)	\$131.00	\$71.21	\$83.40	\$135.96	\$87.06
	200903 (S)	\$118.00	\$64.31	\$70.40	\$122.96	\$74.06
 5 Pin Cylinder for Weiser® Single Cylinder Deadbolt	206005 (P)	\$131.00	\$71.21		\$135.96	
	206005 (S)	\$118.00	\$64.31		\$122.96	
 5 Pin Cylinder for Weiser® Double Cylinder Deadbolt	206100 (P)	\$130.00	\$70.67		\$134.91	
	206100 (S)	\$117.00	\$63.77		\$121.91	
 5 Pin Cylinder for Weiser® 4000, 4200 Single Cylinder Deadbolt	207001 (P)	\$131.00	\$71.21		\$135.96	
	207001 (S)	\$118.00	\$64.31		\$122.96	

## Yale® Deadbolt Cylinders

Description	Part Number	M <sup>3</sup>	BiLevel	X4	Biax/Orig	KeyMark
 6 Pin Cylinder for Yale 3300, 3500, & 3600 Series Deadbolt Locks	2051027 (P)	\$130.00	\$70.67	\$82.40	\$134.91	\$86.01
	2051027 (S)	\$117.00	\$63.77	\$69.40	\$121.91	\$73.01

## Abus® Padlock Cylinders

Description	Part Number	M <sup>3</sup>	BiLevel	X4	Biax/Orig	KeyMark
 6 Pin Cylinder for Abus® Padlock Series 83KNK/45, 83KNK/50 & 83KNK/55	2020000 (P)	\$130.00	\$70.67	\$82.40	\$134.91	\$86.01
	2020000 (S)	\$117.00	\$63.77	\$69.40	\$121.91	\$73.01

## American® Padlock Cylinders

Description	Part Number	M <sup>3</sup>	BiLevel	X4	Biax/Orig	KeyMark
 6 Pin Cylinder for American® 3600/3700 Padlock (Note: Use American® Driver DR-MED6)	2020000 (P)	\$130.00	\$70.67	\$82.40	\$134.91	\$86.01
	2020000 (S)	\$117.00	\$63.77	\$69.40	\$121.91	\$73.01

## Master® Padlock Cylinders

Description	Part Number	M <sup>3</sup>	BiLevel	X4	Biax/Orig	KeyMark
 6 Pin Cylinder for Master® "29" and 6600, 6700 Pro Series (Note: Use Master® Driver 0298-627 for Pro Series)	2020000 (P)	\$130.00	\$70.67	\$82.40	\$134.91	\$86.01
	2020000 (S)	\$117.00	\$63.77	\$69.40	\$121.91	\$73.01

\*\*Refer to the eCylinder section for more detail on specific technologies available and pricing. Technologies are represented by the following letters:  
T = Medeco<sup>3</sup>, S = M<sup>3</sup> CLIQ, J = Medeco<sup>3</sup> BiLevel, W = Biaxial, V = Medeco Biaxial CLIQ, K = Medeco KM, N = Medeco X4, C = Classic CLIQ, M = Medeco X4 CLIQ,  
"." = Original, Z = Medeco Original KW CLIQ, G = Medeco XT \*\*\*See key section for surcharges for custom coined cut keys or special stamping requirements.  
**Note:** (P) refers to **Pinned** and (S) to **Sub-Assembled** at the end of each part string in the price book.

## Medeco System Series Padlock Cylinders

Description	Part Number	M <sup>3</sup>	BiLevel	X4	Biax/Orig	KeyMark
 6 Pin cylinder for System Series KIK style padlocks	510600 (P)	\$101.40	\$55.26	\$88.30	\$105.11	\$91.71
	510600 (S)	\$88.40	\$48.36	\$75.30	\$92.11	\$78.71

New Standard Mfg. Co.<sup>®</sup> Padlock Cylinders

Description	Part Number	M <sup>3</sup>	BiLevel	X4	Biax/Orig	KeyMark
 6 Pin Cylinder for New Standard <sup>®</sup> Padlocks	2020052 (P)	\$130.00	\$70.67	\$82.40	\$134.91	\$86.01
	2020052 (S)	\$117.00	\$63.77	\$69.40	\$121.91	\$73.01

Schlage<sup>®</sup> Padlock Cylinders

Description	Part Number	M <sup>3</sup>	BiLevel	X4	Biax/Orig	KeyMark
 6 Pin Cylinder for Schlage <sup>®</sup> 45-101 Padlock	2020074 (P)	\$130.00	\$70.67	\$82.40	\$134.91	\$86.01
	2020074 (S)	\$117.00	\$63.77	\$69.40	\$121.91	\$73.01

## KIK/KIL Cylinder Components

Description	Part Number	Price
Medeco <sup>3</sup> slider package. (Includes slider & spring)	940174	\$12.00
Medeco BiLevel slider package	940227	\$12.00
Flat Head Machine Screw, 5/16" -#2-56 UNC, Phillips with Nylok Patch for 20-200XX Cylinders. Sold in Bags of 100	CP-010203-050	\$0.21 each
Pan Head Machine Screw, 1/4" -#2-56 UNC, Phillips with Nylok Patch for most Lazy Motion Cylinders. Sold in Bags of 100	CP-010503-040	\$0.33 each
Retaining Ring, Knob Cylinder "E" Clip	CP-020020	\$1.50
Retaining Ring, Knob Cylinder, Full Clip	CP-020040	\$2.90
Retaining Ring, Knob Cylinder Plug Retainer, "C" Clip	CP-020100	\$0.93
Lazy Motion Tailpiece Retainer for 20*090X cylinders	CP-021031	\$1.90
Tailpiece Retainer ring for Arrow and Sargent clip on tailpieces	CP-021130	\$2.70
Plug Retainer, Standard Knob	CP-021370	\$7.30
Castle Nut Retainer for Schlage type lazy motion cylinders	CP-021651	\$11.20
Compression Spring for Schlage type lazy motion cylinders	CP-030670	\$1.50
Drive Disk for Schlage -type Lazy Motion Cylinders	CP-041200	\$3.80
Detent Pin for Schlage type lazy motion cylinders	CP-064490	\$1.80

## KIK/KIL Cylinder Plugs

Description	Part Number	Price
Plug for 20-200XX- (Medeco Original)	12126002 -	\$55.64
Plug for 20W200XX (Medeco Biaxial)	12126156 W	\$55.64
Plug for 20T200XX (Medeco <sup>3</sup> )	1212633 T	\$53.40

## Mailbox Lock Cylinders

Description	Part Number	(S) Pricing	(P) Pricing
6 Pin Medeco <sup>3</sup> Rim Style Mailbox cylinder, less slider	490357 T	\$152.10	N/A
6 Pin Medeco <sup>3</sup> Key in Knob Style Mailbox cylinder, less slider	490375 T	\$149.00	N/A
6 Pin Medeco <sup>3</sup> BiLevel Mailbox cylinder	200104 J	\$70.20	\$77.10
6 Pin Mailbox cylinder. Medeco KM only	200155 K	\$106.36	\$119.36
6 Pin Mailbox cylinder	200156 N	\$101.20	\$114.20

\*\*Refer to the eCylinder section for more detail on specific technologies available and pricing. Technologies are represented by the following letters:  
 T = Medeco<sup>3</sup>, S = M<sup>3</sup> CLIQ, J = Medeco<sup>3</sup> BiLevel, W = Biaxial, V = Medeco Biaxial CLIQ, K = Medeco KM, N = Medeco X4, C = Classic CLIQ, M = Medeco X4 CLIQ,  
 ". " = Original, Z = Medeco Original KW CLIQ, G = Medeco XT \*\*\*See key section for surcharges for custom coined cut keys or special stamping requirements.

**Note:** (P) refers to **Pinned** and (S) to **Sub-Assembled** at the end of each part string in the price book.

## KIK/KIL Cylinder Tailpieces

Description	Part Number	Price
 Tailpiece for Schlage® B200, B400, B500, Series (Double Cylinder)	CT-F34	\$4.00
 Tailpiece for Schlage® F160, B100, B200, B400, B500 Series (Double Cylinder)	CT-F35	\$4.00
 Tailpiece for Schlage® B200, B400 Series (Double Cylinder)	CT-F36	\$4.00
 Tailpiece for Schlage® F160, B100, B200, B400, B500 Series (Double Cylinder)	CT-F37	\$4.00
 Tailpiece for Schlage® "E", F160, "H", B100, B200, B400, B500 Series (Single Cylinder)	CT-F38	\$4.00
 Tailpiece for Baldwin® Images Series	CT-F40	\$12.30
 Tailpiece for Marks® 190S Lever Lockset	CT-V00	\$4.00
 Tailpiece for Marks® 190AB Lever Lockset	CT-V01	\$4.00
 Tailpiece for PDQ® SP	CT-V02	\$4.00
 Tailpiece for Falcon® "T" Series	CT-V03	\$4.00
 Tailpiece for Corbin® Russwin® 3900 Series Lever Lock	CT-V19	\$4.00
 Tailpiece for Sargent® 11 Line TZone	CT-V35	\$8.50
 Tailpiece for Anderson® Door Locks	CT-V39	\$4.00
 Tailpiece for Kwikset®	CT-V40	\$16.80
 Tailpiece for Schlage® Lazy Motion	CT-Y08	\$4.00

\*\*Refer to the eCylinder section for more detail on specific technologies available and pricing. Technologies are represented by the following letters: T = Medeco<sup>3</sup>, S = M<sup>3</sup> CLIQ, J = Medeco<sup>3</sup> BiLevel, W = Biaxial, V = Medeco Biaxial CLIQ, K = Medeco KM, N = Medeco X4, C = Classic CLIQ, M = Medeco X4 CLIQ, "•" = Original, Z = Medeco Original KW CLIQ, G = Medeco XT \*\*\*See key section for surcharges for custom coined cut keys or special stamping requirements.  
**Note:** (P) refers to **Pinned** and (S) to **Sub-Assembled** at the end of each part string in the price book.



## KIK/KIL Cylinder Tailpieces

Description	Part Number	Price
 Tailpiece for Schlage® Deadbolt Lock (.542")	CT-Y24	\$4.00
 Tailpiece for Baldwin®, Falcon®, Marvin®, Weiser® & Yale® (Lazy Motion)	CT-Y27	\$4.00
 Tailpiece for Schlage® “G” Series Knob Lock	CT-Y28	\$19.10
 Tailpiece for Weiser® 4370 Deadbolt Lock	CT-Y29	\$4.00
 Tailpiece for Dexter® Double Cylinder Deadbolt Lock 4209	CT-Y31	\$4.00
 Tailpiece for Sargent® 6 Line (.685" Length)	CT-Y35	\$4.00
 Tailpiece for Sargent® 6 Line	CT-Y37	\$4.00
 Tailpiece for Russwin® Forum (20-5008) Line	CT-Y46	\$4.00
 Tailpiece for Arrow® 151 Knob and Sargent® 10 Line	CT-Y47	\$4.00
 Tailpiece for Schlage® “C”, “D”, & Olympiad® Lever & Falcon® “B”, “F” Series	CT-Y49	\$4.00
 Tailpiece for Schlage® “A” Series & “C”, “D” Series (Ball, Globe, Sphere Design)	CT-Y52	\$4.00
 Tailpiece for Schlage® “A” Series (Orbit Design Only)	CT-Y53	\$4.00
 Tailpiece for Falcon® “S” Series Knob (Except “H” Knob)	CT-Y54	\$4.00
 Tailpiece for Sargent® 10 Line	CT-Y55	\$4.00
 Tailpiece for Yale® AU5400 Lever Handle (Old Style)	CT-Y57	\$4.00

\*\*Refer to the eCylinder section for more detail on specific technologies available and pricing. Technologies are represented by the following letters:  
T = Medeco<sup>3</sup>, S = M<sup>3</sup> CLIQ, J = Medeco<sup>3</sup> BiLevel, W = Biaxial, V = Medeco Biaxial CLIQ, K = Medeco KM, N = Medeco X4, C = Classic CLIQ, M = Medeco X4 CLIQ,  
“.” = Original, Z = Medeco Original KW CLIQ, G = Medeco XT \*\*\*See key section for surcharges for custom coined cut keys or special stamping requirements.

**Note:** (P) refers to **Pinned** and (S) to **Sub-Assembled** at the end of each part string in the price book.

## KIK/KIL Cylinder Tailpieces

Description	Part Number	Price
 Tailpiece for Falcon® "S" Series "H" Knob	CT-Y58	\$4.00
 Tailpiece for Yale® 5400LN Series Lever Lockset	CT-Y67	\$4.00
 Tailpiece for Falcon® "X" Series Knob (Except "H" Knob)	CT-Y68	\$4.00
 Tailpiece for Lockwood® Knob Lock	CT-Y69	\$4.00
 Tailpiece for Arrow® "M" Series, LSDA® 100 Series & Sargent® 6 Line	CT-Y70	\$4.00
 Tailpiece for Falcon® "X" Series "H" Knob	CT-Y71	\$4.00
 Tailpiece for Falcon® "X" Series Lever Lock	CT-Y72	\$4.00
 Tailpiece for Arrow® "M" Series, LSDA® 100 Series & Sargent® 6 Line (B Knob Only), Schlage ND lever	CT-Y73	\$4.00
 Tailpiece for Schlage® 45-101 Padlock	CT-Y74	\$4.00
 Tailpiece for Russwin® 3300 & 4300 Series	CT-Y75	\$4.00
 Tailpiece for Russwin® 3400 Series & Corbin® 6600 Series	CT-Y77	\$4.00
 Tailpiece for LSDA® LX1000 Lever Lockset	CT-Y78	\$4.00
 Tailpiece for Schlage "S" Series	CT-Y97	\$27.40

\*\*Refer to the eCylinder section for more detail on specific technologies available and pricing. Technologies are represented by the following letters:  
T = Medeco<sup>3</sup>, S = M<sup>3</sup> CLIQ, J = Medeco<sup>3</sup> BiLevel, W = Biaxial, V = Medeco Biaxial CLIQ, K = Medeco KM, N = Medeco X4, C = Classic CLIQ, M = Medeco X4 CLIQ,  
"-" = Original, Z = Medeco Original KW CLIQ, G = Medeco XT \*\*\*See key section for surcharges for custom coined cut keys or special stamping requirements.  
**Note:** (P) refers to **Pinned** and (S) to **Sub-Assembled** at the end of each part string in the price book.

**KIK/KIL Tailpiece Packages**

Description	Part Number	Price
Tailpiece Package for Arrow®: Listed as A1 in cylinder part number. Includes CT-Y70, CT-Y73 & CP-160321 (Spacer)	94-0034	\$11.70
Tailpiece Package for Schlage®: Listed as S1 in cylinder part number. Includes CT-Y49, CT-Y52, CT-Y53, CT-Y73, CT-Y74	94-0036	\$11.70
Tailpiece Package for Falcon®: Listed as F1 in cylinder part number. Includes CT-Y49, CT-Y54, CT-Y58, CT-Y68, CT-Y71, CT-Y72 & CP-160311	94-0035	\$11.70
Tailpiece Package for LSDA®: Listed as L1 in cylinder part number. Includes CT-Y49, CT-Y70, CT-Y73, CT-78	94-0272	\$11.70
Tailpiece Package for Schlage® "S" Series: Includes CT-Y97 & CP-021370	94-0051	\$29.70
Tailpiece package for Arrow®, Schlage® & Sargent®: Listed as H1 in cylinder part number. Includes CT-Y49, CT-Y52, CT-Y53, CT-Y54, CTY70, CT-Y73, & CP-160321	94-0061	\$20.70
Tailpiece Package for Sargent® & Arrow®: Includes CT-Y35, CT-Y37, CT-Y47, CT-Y55	94-0067	\$3.40
Tailpiece Package for Schlage® Deadbolt Cylinders: Listed as S4 in cylinder part number. Includes CT-F34, CT-F35, CT-F36, CT-F37, CT-F38	94-0098	\$11.70

\*\*Refer to the eCylinder section for more detail on specific technologies available and pricing. Technologies are represented by the following letters:  
T = Medeco<sup>3</sup>, S = M<sup>3</sup> CLIQ, J = Medeco<sup>3</sup> BiLevel, W = Biaxial, V = Medeco Biaxial CLIQ, K = Medeco KM, N = Medeco X4, C = Classic CLIQ, M = Medeco X4 CLIQ,  
"." = Original, Z = Medeco Original KW CLIQ, G = Medeco XT \*\*\*See key section for surcharges for custom coined cut keys or special stamping requirements.

**Note:** (P) refers to **Pinned** and (S) to **Sub-Assembled** at the end of each part string in the price book.

# Large Format Interchangeable Cores

FEATURES	Medeco <sup>3</sup>	BiLevel	Medeco X4	CLIQ	Medeco XT
Utility patented key control provides protection from unauthorized duplication of keys	●	●	●	●	●
UL437 Listing and BHMA Certification provide validation of high security from recognized, independent testing laboratories	●				
Triple locking principle provides pick resistance and large numbers of combinations for master keying flexibility to accommodate systems of virtually any size	●				
Hardened steel inserts in the cylinder face and hardened steel driver pins provide proven drill resistance	●				
Solid brass construction provides high quality and long cylinder life	●	●	●		
Nickel plated pins designed to provide exceptional wear resistance	●	●	●		
Retrofits into virtually any manufacturers' locksets with a wide selection of interchangeable cams to fit various mortise series hardware for cost effective improved security	●	●	●	●	●
Ability to key with non-interchangeable core cylinders, including rim and mortise, knob style for Medeco BiLevel cost effective system flexibility	●	●	●		
High security and key control may be incorporated in a single system for cost effective system flexibility	●	●		●	

## Medeco<sup>3</sup> Premium High Security

For effective mechanical protection against most forms of attack as well as protection against unauthorized duplicate keys, Medeco<sup>3</sup> cylinders are recommended. Security features including hardened steel components, pins that must be elevated, rotated, and interact with both a sidebar and a slider, and additional pick resistant features make Medeco<sup>3</sup> the cylinder of choice to protect people, property and information.

## Medeco<sup>3</sup> BiLevel Patented Key Control

Medeco<sup>3</sup> BiLevel cylinders may be incorporated into a master key system with Medeco<sup>3</sup> high security, offering protection against all types of attack where needed, and patented key control cylinders for areas requiring less protection. BiLevel cylinders offer patented control against unauthorized duplication of keys without the additional security features protecting against force or surreptitious attack.

## Medeco X4 Patented Key Control

Medeco X4 cylinders offer patented control against unauthorized duplication of keys without the additional security features protecting against force or surreptitious attack.

## Intelligent Key Solutions

Many of the cylinders in this section are also available with an Intelligent Key solution. See the Intelligent Key section for more details.

# Large Format Interchangeable Cores

Offering increased security with rapid combination changes, interchangeable core cylinders enable quick and easy cylinder changes by non-technical personnel by using a special control key to remove the cylinder (core) from the lock housing. A core with a new combination can then be inserted, which in effect rekeys the lock. All of this can be done without having to take the lock apart, which reduces the expense of calling outside service personnel to perform routine lock rekeys. These cylinder/core combinations are often used on doors of high-turnover businesses, like fast-food or manufacturing environments, where rapid rekeying is often desirable. Medeco's patented high security technology provides protection against unauthorized duplication of keys, along with hardened inserts to resist drilling and features that protect against other types of attack.



## Patented Key Control

Protects against unauthorized duplication of your keys.



## Uses Existing Hardware

Medeco offers the largest selection of retrofit Large Format Interchangeable Cores (LFIC) that reduce cost by eliminating the need to replace your existing hardware.



## Quickly Change Cores

Provides quick and easy cylinder changes in the event keys are lost or stolen.



## Protection From Physical Attack

Medeco<sup>3</sup> LFIC cylinders are UL 437 Listed and use hardened stainless steel inserts in the cylinder face to provide drill and pick resistance resistance.



## Special Angle Cut Keys

Requires a special key cutting machine and access to Medeco specific blanks, available in a variety of restrictions to support every need.



## Picking and Bumping Protection

Medeco<sup>3</sup> cylinders use a sidebar that prevent the key from rotating until it is elevated, rotated and aligned in the correct position. This feature protects against bumping and picking attacks.

## Technical Information:

- Medeco format meets ANSI A156.30 Level A, assuring patent protected key control and physical strength
- ANSI A156.5 Grade 1 certification assures consistent quality for heavy use applications
- Solid brass construction provides high quality and long cylinder life
- Nickel plated pins provide exceptional wear resistance and additional hardened stainless steel pins provide drill resistance
- Ability to key with non-interchangeable core cylinders, including rim & mortise and knob style for cost effective system flexibility

## Applications:

Office buildings, universities, apartments, perimeter doors, schools and hospitals.

## Warranty:

Warranted for two (2) years against manufacturer's defects. See Medeco's limited warranty for full details.

## Finishes:

Available in all standard finishes to match with existing hardware.

## Available Key Technologies:













### Mechanical:

- Medeco<sup>3</sup>
- Medeco<sup>3</sup> BiLevel
- Medeco X4

### eCylinder:

- M<sup>3</sup> CLIQ
- Classic CLIQ

## Large Format Interchangeable Core







Description	Part Number	M <sup>3</sup>	BiLevel	X4	Biax/Orig	KeyMark
 Yale® Large Format Interchangeable Core, 6 Pin (Masterkey upcharges apply)	310100 (P)	\$144.00	\$78.70	\$95.10	\$149.50	\$98.20
	310100 (S)	\$131.00	\$71.80	\$82.10	\$136.50	\$85.20
 Control Keyblank for 31-0100 cylinders	KYB XX6X11	\$8.90			\$8.90	
 6 Pin Core for 7 Pin Yale® Large Format Interchangeable Core Housing (Masterkey upcharges apply)	310100A (P)	\$144.00	\$78.70	\$95.10	\$149.50	\$98.20
	310100A (S)	\$131.00	\$71.80	\$82.10	\$136.50	\$85.20
 Control key blank for 31-0100A cylinders	KYB XX7X11	\$8.90				
 6 Pin Interchangeable Core Construction Core (Yale® Style) Cut keys provided separately – 12 keys Maximum	310100CC BIR1				\$149.50	
 5 Pin Large Format Interchangeable Core (Masterkey upcharges apply)	320101 (P)	\$143.00	\$77.75		\$148.46	
	320101 (S)	\$130.00	\$70.85		\$135.46	
 5 Pin Large Format Interchangeable Core for Simplex® Unican® 1000-2m Manufactured Before 2/10/92 (Masterkey upcharges apply)	320101H (P)	\$143.00			\$148.46	
	320101H (S)	\$130.00			\$135.46	
 6 Pin Large Format Interchangeable Core (Masterkey upcharges apply)	320201 (P)	\$144.00	\$78.30	\$100.30	\$149.50	
	320201 (S)	\$131.00	\$71.39	\$87.30	\$136.50	
 6 Pin Large Format Interchangeable Core for Simplex® Unican® 1000-2m Manufactured Before 2/10/92 (Masterkey upcharges apply)	320201H (P)	\$144.00	\$78.30		\$149.50	
	320201H (S)	\$131.00	\$71.39		\$136.50	
 6 Pin Large Format Removable Core Construction Core Cut keys sold separately – 12 keys maximum	320201CC BIR1				\$149.50	
 6 Pin Large Format Hotel Function Interchangeable Core (Masterkey upcharges apply)	321201 (P)	\$147.00			\$152.63	
	321201 (S)	\$134.00			\$139.63	
 6 Pin Large Format Interchangeable Core Hotel Function with Extended Plug Face (Masterkey upcharges apply)	321201D (P)	\$167.70			\$173.33	
	321201D (S)	\$154.70			\$160.33	
 6 Pin Large Format Interchangeable Core with Extended Plug Face (Masterkey upcharges apply)	324201 (P)	\$144.00	\$78.29		\$149.50	
	324201 (S)	\$131.00	\$71.39		\$136.50	

\*\*Refer to the eCylinder section for more detail on specific technologies available and pricing. Technologies are represented by the following letters:  
T = Medeco<sup>3</sup>, S = M<sup>3</sup> CLIQ, J = Medeco<sup>3</sup> BiLevel, W = Biaxial, V = Medeco Biaxial CLIQ, K = Medeco KM, N = Medeco X4, C = Classic CLIQ, M = Medeco X4 CLIQ,  
“.” = Original, Z = Medeco Original KW CLIQ, G = Medeco XT \*\*\*See key section for surcharges for custom coined cut keys or special stamping requirements.

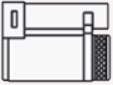
**Note:** (P) refers to **Pinned** and (S) to **Sub-Assembled** at the end of each part string in the price book.

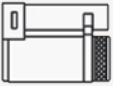





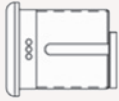

Large Format Interchangeable Core

Description	Part Number	M <sup>3</sup>	BiLevel	X4	Biax/Orig	KeyMark
 6 Pin Emergency Keyblank for 321201	KYB XX6620XX05	\$8.90				
 6 Pin Large Format Interchangeable Core (Schlage®) – X4 (Masterkey upcharges apply)	322201 (P)			\$99.90		\$104.34
	322201 (S)			\$86.90		\$91.34
 X4 Control Keyblank for 322201	KYB XX7X31			\$8.90		
 5 Pin Large Format Interchangeable Core (Schlage®) – M <sup>3</sup> (Masterkey upcharges apply)	322201 (P)	\$152.00			\$99.90	
	322201 (S)	\$139.00			\$86.90	
 M <sup>3</sup> Control Keyblank for 322201	KYB XX6X31	\$8.90				
 6 Pin Large Format Interchangeable Core (Corbin Russwin®) (Masterkey upcharges apply) Not available in Original Technology*	322301 (P)	\$144.00		\$100.30	\$149.50 *	\$104.60
	322301 (S)	\$131.00		\$87.30	\$136.50 *	\$91.60
 6 Pin Large Format Interchangeable Core (Sargent®), (Masterkey upcharges apply)	322401 (P)	\$144.00		\$100.30	\$149.50	\$104.60
	322401 (S)	\$131.00		\$87.30	\$136.50	\$91.60
 7 Pin Large Format Interchangeable Core (Corbin Russwin®), (Masterkey upcharges apply)	322801 (P)			\$109.30		\$113.98
	322801 (S)			\$96.30		\$100.98

\*\*Refer to the eCylinder section for more detail on specific technologies available and pricing. Technologies are represented by the following letters: T = Medeco<sup>3</sup>, S = M<sup>3</sup> CLIQ, J = Medeco<sup>3</sup> BiLevel, W = Biaxial, V = Medeco Biaxial CLIQ, K = Medeco KM, N = Medeco X4, C = Classic CLIQ, M = Medeco X4 CLIQ, “.” = Original, Z = Medeco Original KW CLIQ, G = Medeco XT \*\*\*See key section for surcharges for custom coined cut keys or special stamping requirements. **Note:** (P) refers to Pinned and (S) to Sub-Assembled at the end of each part string in the price book.













## LFIC Mortise Cylinders

Description	Part Number	M <sup>3</sup>	BiLevel	X4	Biax/Orig	KeyMark
 6 Pin Mortise Cylinder for Yale® (Masterkey upcharges apply)	310101 (P)	\$235.00	\$169.70		\$244.32	
	310101 (S)	\$222.00	\$162.80		\$231.32	
 7 Pin Mortise Cylinder Assembly for Yale® (Masterkey upcharges apply)	310101A (P)	\$235.00	\$169.70		\$244.32	
	310101A (S)	\$222.00	\$162.80		\$231.32	
 5 Pin 1" Mortise Cylinder Assembly (Masterkey upcharges apply)	320100 (P)	\$234.00	\$166.02		\$243.28	
	320100 (S)	\$221.00	\$159.12		\$230.28	
 6 Pin 1 1/4" Mortise Cylinder Assembly (Masterkey upcharges apply)	320200 (P)	\$235.00	\$166.74		\$244.32	
	320200 (S)	\$222.00	\$159.84		\$231.32	
 6 Pin LFIC Mortise Cylinder Assembly Hotel Function (Masterkey upcharges apply)	321200 (P)	\$229.70			\$238.80	
	321200 (S)	\$216.70			\$225.80	
 6 Pin Mortise Cylinder Master Corbin Russwin® Ring Size Assembly (Masterkey upcharges apply)	321350 (P)	\$270.00			\$280.79	
	321350 (S)	\$257.00			\$267.79	
 6 Pin LFIC Mortise Cylinder Assembly with Raised Plug Face (Masterkey upcharges apply)	324200 (P)	\$227.20			\$236.20	
	324200 (S)	\$214.20			\$223.20	
 6 Pin 1 1/2" LFIC Mortise Cylinder Assembly (Masterkey upcharges apply)	325200 (P)	\$390.00			\$405.83	
	325200 (S)	\$377.00			\$392.83	
 6 Pin 1 3/4" LFIC Mortise Cylinder Assembly (Masterkey upcharges apply)	325400 (P)	\$404.00			\$420.42	
	325400 (S)	\$391.00			\$407.42	
 6 Pin 2" LFIC Mortise Cylinder Assembly (Masterkey upcharges apply)	325500 (P)	\$416.00			\$432.93	
	325500 (S)	\$403.00			\$419.93	
 6 Pin 2 1/4" LFIC Mortise Cylinder Assembly (Masterkey upcharges apply)	325300 (P)	\$412.00			\$428.76	
	325300 (S)	\$399.00			\$415.76	
 6 Pin 2 5/8" LFIC Mortise Assembly (Masterkey upcharges apply)	325600 (P)	\$447.00			\$465.23	
	325600 (S)	\$434.00			\$452.23	
 6 Pin 3" LFIC Mortise Assembly (Masterkey upcharges apply)	325700 (P)	\$466.00			\$485.03	
	325700 (S)	\$453.00			\$472.03	

\*\*Refer to the eCylinder section for more detail on specific technologies available and pricing. Technologies are represented by the following letters:  
T = Medeco<sup>3</sup>, S = M<sup>3</sup> CLIQ, J = Medeco<sup>3</sup> BiLevel, W = Biaxial, V = Medeco Biaxial CLIQ, K = Medeco KM, N = Medeco X4, C = Classic CLIQ, M = Medeco X4 CLIQ,  
".." = Original, Z = Medeco Original KW CLIQ, G = Medeco XT \*\*\*See key section for surcharges for custom coined cut keys or special stamping requirements.

**Note:** (P) refers to **Pinned** and (S) to **Sub-Assembled** at the end of each part string in the price book.

**LFIC Mortise Housings**

Description	Part Number	Medeco <sup>3</sup>	BiLevel	Medeco X4
 5 Pin Mortise Cylinder Housing	32-0175	\$91.50		
 6 Pin Mortise Cylinder Housing	32-0275	\$91.50		
 6 Pin Jumbo Mortise Cylinder Housing for Corbin® Russwin® Master Ring Cylinders	32-1375	\$126.00		
 1 1/2" Mortise Cylinder Housing for 32-5200	32-5275	\$248.00		
 1 3/4" Mortise Cylinder Housing for 32-5400	32-5475	\$261.00		
 2" Mortise Cylinder Housing for 32-5500	32-5575	\$273.00		
 2 1/4" Mortise Cylinder Housing for 32-5300	32-5375	\$286.00		
 2 5/8" Mortise Cylinder Housing for 32-5600	32-5675	\$303.00		
 3" Mortise Cylinder Housing for 32-5700	32-5775	\$323.00		
 6 Pin 1 3/8" Mortise Cylinder Housing (Yale®)	31-0175	\$91.50		
 7 Pin Mortise Cylinder Housing (Yale®)	31-0175A	\$91.50		
 2 1/4" Mortise Cylinder Housing (Yale®)	31-5375	\$277.00		

\*\*Refer to the eCylinder section for more detail on specific technologies available and pricing. Technologies are represented by the following letters: T = Medeco<sup>3</sup>, S = M<sup>3</sup> CLIQ, J = Medeco<sup>3</sup> BiLevel, W = Biaxial, V = Medeco Biaxial CLIQ, K = Medeco KM, N = Medeco X4, C = Classic CLIQ, M = Medeco X4 CLIQ, “.” = Original, Z = Medeco Original KW CLIQ, G = Medeco XT \*\*\*See key section for surcharges for custom coined cut keys or special stamping requirements.  
**Note:** (P) refers to **Pinned** and (S) to **Sub-Assembled** at the end of each part string in the price book.

## LFIC Rim Cylinders

Description	Part Number	M <sup>3</sup>	BiLevel	X4	Biax/Orig	KeyMark
 6 Pin Rim Cylinder Assembly for Yale®, Horizontal Tailpiece (Masterkey upcharges apply)	310102H (P)	\$243.00	\$177.70		\$252.66	
	310102H (S)	\$230.00	\$170.80		\$239.66	
 6 Pin Rim Cylinder Assembly for Yale®, Vertical Tailpiece (Masterkey upcharges apply)	310102V (P)	\$243.00	\$172.50		\$252.66	
	310102V (S)	\$230.00	\$165.60		\$239.66	
 7 Pin Rim Cylinder Assembly for Yale®, Horizontal Tailpiece (Masterkey upcharges apply)	310104H (P)	\$243.00			\$252.66	
	310104H (S)	\$230.00			\$239.66	
 7 Pin Rim Cylinder Assembly for Yale®, Vertical Tailpiece (Masterkey upcharges apply)	310104V (P)	\$243.00			\$252.66	
	310104V (S)	\$230.00			\$239.66	
 5 Pin Rim Cylinder Assembly with Horizontal Tailpiece and Staked Tailpiece Retainer for Thin Door Applications (Masterkey upcharges apply)	320300H (P)	\$228.00	\$161.70		\$237.03	
	320300H (S)	\$215.00	\$154.80		\$224.03	
 5 Pin Rim Cylinder Assembly, Vertical Tailpiece (Masterkey upcharges apply)	320300V (P)	\$228.00	\$161.70		\$237.03	
	320300V (S)	\$215.00	\$154.80		\$224.03	
 6 Pin Rim Cylinder Assembly, Horizontal Tailpiece (Masterkey upcharges apply)	320400H (P)	\$243.00	\$172.50		\$252.66	
	320400H (S)	\$230.00	\$165.60		\$239.66	
 6 Pin Rim Cylinder Assembly, Vertical Tailpiece (Masterkey upcharges apply)	320400V (P)	\$243.00	\$172.50		\$252.66	
	320400V (S)	\$230.00	\$165.60		\$239.66	
 5 Pin Rim Cylinder Assembly with Lazy Motion Tailpiece (Masterkey upcharges apply)	320600 (P)	\$225.90			\$234.84	
	320600 (S)	\$212.90			\$221.84	
 6 Pin Lazy Motion Rim Cylinder Assembly (Masterkey upcharges apply)	320700 (P)	\$244.00			\$253.70	
	320700 (S)	\$231.00			\$240.70	
 6 pin Rim Cylinder with Sargent mounting holes (Masterkey upcharges apply)	320405H (P)	\$258.00			\$268.29	
	320405H (S)	\$245.00			\$255.29	

\*\*Refer to the eCylinder section for more detail on specific technologies available and pricing. Technologies are represented by the following letters:  
T = Medeco<sup>3</sup>, S = M<sup>3</sup> CLIQ, J = Medeco<sup>3</sup> BiLevel, W = Biaxial, V = Medeco Biaxial CLIQ, K = Medeco KM, N = Medeco X4, C = Classic CLIQ, M = Medeco X4 CLIQ,  
“-” = Original, Z = Medeco Original KW CLIQ, G = Medeco XT \*\*\*See key section for surcharges for custom coined cut keys or special stamping requirements.

**Note:** (P) refers to **Pinned** and (S) to **Sub-Assembled** at the end of each part string in the price book.

## LFIC Rim Cylinder Housings

Description	Part Number	Price
 7 Pin Rim Cylinder Housing (Yale®), Horizontal Tailpiece	31-0153H	\$99.00
 7 Pin Rim Cylinder Housing (Yale®), Vertical Tailpiece	31-0153V	\$99.00
 6 Pin 1 1/2" Rim Cylinder Housing (31 series for Yale®), Horizontal Tailpiece	31-0375H	\$99.00
 6 Pin 1 1/2" Rim Cylinder Housing (31 series for Yale), Vertical Tailpiece	31-0375V	\$99.00
 6 Pin Rim Cylinder Housing - 31 Series with Sargent® mounting hole spacing	31-0375S	\$99.00
 5 Pin Rim Cylinder Housing, Horizontal Tailpiece	32-0375H	\$86.90
 5 Pin Rim Cylinder Housing, Vertical Tailpiece	32-0375V	\$86.90
 6 Pin Rim Cylinder Housing, Horizontal Tailpiece	32-0475H	\$99.00
 6 Pin Rim Housing, Vertical Tailpiece	32-0475V	\$99.00
 6 Pin Rim Cylinder Housing - 32 Series with Sargent® mounting hole spacing	32-0477H	\$99.00
 5 Pin Rim Cylinder Housing with Lazy Motion Tailpiece	32-0675	\$88.00
 6 Pin Rim Lazy Motion Cylinder Housing	32-0775	\$100.00

\*\*Refer to the eCylinder section for more detail on specific technologies available and pricing. Technologies are represented by the following letters:  
T = Medeco<sup>3</sup>, S = M<sup>3</sup> CLIQ, J = Medeco<sup>3</sup> BiLevel, W = Biaxial, V = Medeco Biaxial CLIQ, K = Medeco KM, N = Medeco X4, C = Classic CLIQ, M = Medeco X4 CLIQ,  
“-” = Original, Z = Medeco Original KW CLIQ, G = Medeco XT \*\*\*See key section for surcharges for custom coined cut keys or special stamping requirements.  
**Note:** (P) refers to **Pinned** and (S) to **Sub-Assembled** at the end of each part string in the price book.

# Small Format Interchangeable Cores

FEATURES	Medeco <sup>®</sup>	Medeco X4	Medeco XT
Utility patented key control provides protection from unauthorized duplication of keys		●	●
Available in a large selection of competitive keyways	●		
Solid brass construction provides high quality and long cylinder life	●	●	
Nickel plated pins designed to provide exceptional wear resistance	●	●	
Retrofits into virtually any manufacturers' locksets with a wide selection of interchangeable cams to fit various mortise series hardware for cost effective improved security	●	●	●
Ability to key with non-interchangeable core cylinders, including rim and mortise, knob style for Medeco BiLevel cost effective system flexibility		●	

## Medeco<sup>®</sup> SFIC

Medeco<sup>®</sup> is an economical solution, available in a large selection of competitive keyways including: AB, BB, CB, DB, EB, FB, GB, HB, JB, KB, LB, MB, QB, RB, TA, TB, TC, TD, TE, WA, WB, WC, WG, WH & WY.

## Medeco XT Intelligent Key Solution

Many of the cylinders in this section are also available with a Medeco XT Intelligent Key solution. See the Medeco XT section for more details.

## Medeco X4 Patented Key Control

Medeco X4 cylinders offer patented control against unauthorized duplication of keys without the additional security features protecting against force or surreptitious attack.



# Small Format Interchangeable Core

Medeco X4 leads the market in patent protected small format interchangeable core (SFIC) cylinders, large format interchangeable core (LFIC) cylinders, conventional mortise, rim and key-in-knob cylinders designed to retrofit virtually any door. One key will operate interchangeable cores and conventional cylinders. With patents extending through 2027 and the ability to expand key systems to four times that of standard SFIC, Medeco X4 is guaranteed to be an important product to suit your needs.



### Patented Key Control

Protects against unauthorized duplication of your keys.



### Uses Existing Hardware

Industry standard Small Format Interchangeable Cores (SFIC) size, reduces cost by eliminating the need to replace your existing hardware.



### Quickly Change Cores

Provides quick and easy cylinder changes in the event keys are lost or stolen.



### Available in eCylinder

SFIC cores are also available in the Medeco XT eCylinder format for Loss & Liability control.

## Technical Information:

- Utilizes the standard A2 pinning system in conjunction with a bitted slider locking arrangement which allows for more master keying capabilities for large master key systems. Up to 65,536 unique change keys in a 7 pin master key system on a single keyway
- ANSI A156.5 Grade 1 certification assures consistent quality for heavy use applications
- Expandable, simple master keying available in SFIC and LFIC, as well as standard key-in-knob, mortise, and rim cylinders
- SFIC's are available in six or seven pin cylinders, and can replace Best style cores
- Standard Medeco cams and tailpieces can be used on Medeco X4 cylinders
- Keys can be cut using many standard code type key machines such as the Pro-Lok Blue Punch, A1 Green Machine, the ITL 9000/9700, HPC 1200 and HPC Code Max

- Solid brass construction for excellent durability
- Spool shaped top and bottom pins add a measure of pick resistance
- Solid nickel silver bottom pins increase wear resistance
- Individual pin chamber caps provide for ease of servicing
- Locks can be keyed alike, keyed different, or master keyed depending on your specific needs.

## Applications:

Provides a key control retrofit for other manufacturers SFIC products in use in a variety of facilities.

## Warranty:

Warranted for two (2) years against manufacturer's defects. See the Medeco® limited warranty for full details.

## Finishes:

Available in all standard finishes to match with existing hardware.

## Available Key Technologies:











### Mechanical:

- Medeco X4
- Medeco<sup>B</sup>

### eCylinder:





- Medeco XT

## Small Format Interchangeable Core

Description	Part Number	Medeco <sup>B</sup>	X4	KeyMark
 6 Pin Small Format Interchangeable Core with Clip Retainer	33600006 (P)		\$71.20	\$73.64
	33600006 (S)		\$58.20	\$60.64
 6 Pin Small Format Interchangeable Core with Clip Retainer, in Alphabet & T Keyways	33-6B010 (P)	\$31.90		
	33-6B010 (S)	\$14.40		
 6 Pin Small Format Interchangeable Core with Clip Retainer, in W Series Keyway	33-6B01W (P)	\$31.90		
	33-6B01W (S)	\$14.40		
 7 Pin Small Format Interchangeable Core with Clip Retainer	33700006 (P)		\$71.20	\$73.64
	33700006 (S)		\$58.20	\$60.64
 7 Pin Small Format Interchangeable Core with Clip Retainer, in Alphabet & T Keyways	33-7B010 (P)	\$31.90		
	33-7B010 (S)	\$14.40		
 7 Pin Small Format Interchangeable Core with Clip Retainer, in W Series Keyway	33-7B01W(P)	\$31.90		
	33-7B01W (S)	\$14.40		
 6 Pin Small Format Interchangeable Core Construction Core (cut keys ordered separately – 12 keys maximum)	33600006 BI CC K		\$71.20	\$73.64
 6 Pin Small Format Interchangeable Core, Extended Plug Head with Clip Retainer	33600007 K (P)		\$71.20	\$73.64
	33600007 K (S)		\$58.20	\$60.64
 7 Pin Small Format Interchangeable Core, Extended Plug Head with Clip Retainer	33700007 K (P)		\$71.20	\$73.64
	33700007 K (S)		\$58.20	\$60.64
 Medeco X4 Specialty Sliding Door Cylinder	3370000S (P)		\$76.60	\$79.04
	3370000S (S)		\$63.60	\$66.04

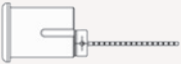
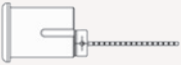
\*\*Refer to the eCylinder section for more detail on specific technologies available and pricing. Technologies are represented by the following letters:  
T = Medeco<sup>3</sup>, S = M<sup>3</sup> CLIQ, J = Medeco<sup>3</sup> BiLevel, W = Biaxial, V = Medeco Biaxial CLIQ, K = Medeco KM, N = Medeco X4, C = Classic CLIQ, M = Medeco X4 CLIQ,  
“-” = Original, Z = Medeco Original KW CLIQ, G = Medeco XT \*\*\*See key section for surcharges for custom coined cut keys or special stamping requirements.  
**Note:** (P) refers to **Pinned** and (S) to **Sub-Assembled** at the end of each part string in the price book.

## SFIC Rim Cylinders

Description	Part Number	Medeco <sup>B</sup>	X4	KeyMark
 6 Pin SFIC with 1 1/4" Rim Assembly	33602032 (P)		\$111.90	\$115.92
	33602032 (S)		\$98.90	\$102.92
 6 Pin SFIC with 1 1/2" Rim Assembly	33602042 (P)		\$111.90	\$115.92
	33602042 (S)		\$98.90	\$102.92
 7 Pin SFIC with 1 1/2" Rim Assembly	33702042 (P)		\$111.90	\$115.92
	33702042 (S)		\$98.90	\$102.92
 7 Pin SFIC with Corbin Russwin® Master Ring Assembly	337020B2 (P)		\$111.90	\$115.92
	337020B2 (S)		\$98.90	\$102.92
 6 Pin SFIC with 1 1/2" Ext.Face Rim Assembly. Medeco KM only.	33602033 K(P)		\$111.90	\$115.92
	33602033 K(S)		\$98.90	\$102.92
 6 Pin SFIC with 1 1/2" Ext.Face Rim Assembly. Medeco KM only.	33602043 K(P)		\$111.90	\$115.92
	33602043 K(S)		\$98.90	\$102.92
 7 Pin SFIC with 1 1/2" Ext.Face Rim Assembly. Medeco KM only.	33702043 K(P)		\$111.90	\$115.92
	33702043 K(S)		\$98.90	\$102.92

\*\*Refer to the eCylinder section for more detail on specific technologies available and pricing. Technologies are represented by the following letters:  
T = Medeco<sup>3</sup>, S = M<sup>3</sup> CLIQ, J = Medeco<sup>3</sup> BiLevel, W = Biaxial, V = Medeco Biaxial CLIQ, K = Medeco KM, N = Medeco X4, C = Classic CLIQ, M = Medeco X4 CLIQ,  
"." = Original, Z = Medeco Original KW CLIQ, G = Medeco XT \*\*\*See key section for surcharges for custom coined cut keys or special stamping requirements.  
**Note:** (P) refers to **Pinned** and (S) to **Sub-Assembled** at the end of each part string in the price book.

## SFIC Mortise Cylinders

Description	Part Number	Medeco <sup>B</sup>	X4	KeyMark
 6 Pin SFIC 1 1/4" Mortise Assembly	33602012 (P)		\$108.70	\$112.72
	33602012 (S)		\$95.70	\$99.72
 7 Pin SFIC 1 3/8" Mortise Assembly	33702022 (P)		\$108.70	\$112.72
	33702022 (S)		\$95.70	\$99.72
 7 Pin SFIC 1 3/8" Corbin® Jumbo Assembly	337020C2 (P)		\$108.70	\$112.72
	337020C2 (S)		\$95.70	\$99.72
 7 Pin SFIC 1 1/2" Mortise Cylinder Assembly	337020E2 (P)		\$108.70	\$112.72
	337020E2 (S)		\$95.70	\$99.72
 6 Pin SFIC 1 1/4" Ext. Face Mortise Assembly Medeco KM only	33602013 K(P)			\$112.72
	33602013 K(S)			\$99.72
 7 Pin SFIC 1 3/8" Ext. Face Mortise Assembly Medeco KM only	33702023 K(P)			\$112.72
	33702023 K(S)			\$99.72
 6 Pin SFIC 7/8" body length (1 3/8" overall) Tapered Head Mortise Assembly	33602052 (P)		\$108.70	\$112.72
	33602052 (S)		\$95.70	\$99.72
 6 Pin SFIC 1" body length (1 1/2" overall) Tapered Head Mortise Assembly (can accept 7 pin core)	33602062 (P)		\$108.70	\$112.72
	33602062 (S)		\$95.70	\$99.72
 6 Pin SFIC 7/8" body length (1 3/8" overall) Ext. Face Tapered Head Mortise Assembly	33602053 K(P)		\$108.70	\$112.72
	33602053 K(S)		\$95.70	\$99.72
 6 Pin SFIC 1" body length (1 1/2" overall) Ext. Face Tapered Head Mortise Assembly (can accept 7 pin core)	33602063 K(P)		\$108.70	\$99.72
	33602063 K(S)		\$95.70	\$99.72

\*\*Refer to the eCylinder section for more detail on specific technologies available and pricing. Technologies are represented by the following letters:  
T = Medeco<sup>3</sup>, S = M<sup>3</sup> CLIQ, J = Medeco<sup>3</sup> BiLevel, W = Biaxial, V = Medeco Biaxial CLIQ, K = Medeco KM, N = Medeco X4, C = Classic CLIQ, M = Medeco X4 CLIQ,  
"-" = Original, Z = Medeco Original KW CLIQ, G = Medeco XT \*\*\*See key section for surcharges for custom coined cut keys or special stamping requirements.  
**Note:** (P) refers to **Pinned** and (S) to **Sub-Assembled** at the end of each part string in the price book.

## SFIC Housings

Description	Part Number	Price
 6 Pin 1 1/4" Mortise Housing Only	33-076011	\$18.60
 6 or 7 Pin 1 3/8" Mortise Housing Only	33-076021	\$18.60
 7 Pin 1 1/2" SFIC Mortise Housing Only, (If using 6 Pin core spacer CP-160420 required)	33-076025	\$37.40
 7 Pin 1 3/8" Housing Only for Corbin® Russwin® Master Ring Cylinders*	33-076028	\$55.30
 6 Pin 7/8" Tapered Head Mortise Housing Only	33-076051	\$18.60
 6 or 7 Pin 1" Tapered Head Mortise Housing Only	33-076061	\$18.60
 6 Pin 1 1/2" Rim Cylinder Housing Only	33-07603H	\$18.60
 7 Pin 1 1/2" Rim Cylinder Housing Only	33-07604H	\$18.60
 7 Pin Corbin® Jumbo Rim Housing Only	33-076048	\$55.30

## Showcase Lock Housing

Description	Part Number	Price
Showcase lock for SFIC cylinder. Works with Medeco X4, Medeco XT SFIC, or best style SFIC. SFIC sold separately.	33-07340	\$76.50

\*\*Refer to the eCylinder section for more detail on specific technologies available and pricing. Technologies are represented by the following letters:  
T = Medeco<sup>3</sup>, S = M<sup>3</sup> CLIQ, J = Medeco<sup>3</sup> BiLevel, W = Biaxial, V = Medeco Biaxial CLIQ, K = Medeco KM, N = Medeco X4, C = Classic CLIQ, M = Medeco X4 CLIQ,  
"-" = Original, Z = Medeco Original KW CLIQ, G = Medeco XT \*\*\*See key section for surcharges for custom coined cut keys or special stamping requirements.  
**Note: (P)** refers to **Pinned** and **(S)** to **Sub-Assembled** at the end of each part string in the price book.

# Medeco T21 Key Management System

The Medeco T21 is a sophisticated stand-alone key management system which combines innovative RFID technology and robust design to provide small to medium-sized businesses with the advanced management of 21 keys or keysets in a plug and play solution.



## Operation:

- Stand-alone plug & play solution with advanced RFID technology
- Touchscreen interface
- PIN access to designated keys or keysets which are individually locked in place
- Keys are securely attached using special security seals
- Simple to configure through the setup wizard
- No requirement for network connection or PC
- Concealed robust fixing points allow secure wall fixing
- Mains operated with optional battery backup
- 1,000 users per system
- System can save 250,000 audit events

## iFob

Once attached to an iFob with a robust security seal, individual keys or keysets are assigned to a specific user.

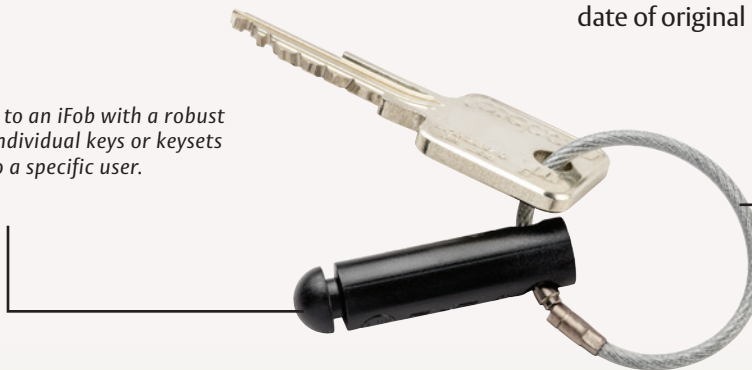

## Security Seal

The secure one-time security seal is cost-effective and simple to apply without the need for specific tools.

## Technical Information:

- User, key and access rights administration
- Multilingual functionality
- Screen-based audit trail and reporting capability or export via USB port
- 21 robust, long-live iFobs with security seals
- 21 locking receptors with LEDs
- Robust and compact steel housing eliminates exposed hinges and obvious access points
- Manual override and door release functions in case of emergency
- Audible alarms

## Warranty:

Medeco warrants the T21 to be free of defects in material and/or workmanship for a period of one (1) year from date of original purchase.

## T21 Key Management System

Description	Part Number	Price
Medeco T21 Key Management System, comes with 21 ifobs and security seals.	EA-100117	\$2,784.00
Security Seal	EA-100148	\$6.70 ea
iFob	EA-100149	\$33.20 ea
Battery	EA-100154	\$78.20
T21 Key override replacement lock	960590 W 26-S6	\$115.68



# International Cylinders

Medeco® cylinders are used to protect facilities worldwide such as high security government installations, industrial and institutional organizations, airports, hotels, power plants, palaces, museums, universities, schools, and office buildings. Medeco's international cylinders are designed to fit in locksets of major world manufacturers. In addition to international uses, many of these cylinders fit imported hardware used in North America. Medeco offers a variety of export cylinders including European profile and modular cylinders. These products are available in both mechanical and eCylinder technologies. The Medeco European Profile cylinder has a teardrop shape that fits into storm doors, upscale hardware and specialty applications and is available in single, half and double cylinder versions. Additional cylinders in the 23 series include: oval, round, and "snowman" designs.



#### Patented Key Control

Protects against unauthorized duplication of your keys.



#### Uses Existing Hardware

European profile cylinders retrofit into virtually any manufacturers' locksets requiring DIN Standard cylinders



#### Available in eCylinder

Medeco's international cylinders are also available in eCylinder format for loss & liability control.



#### Protection From Physical Attack

Medeco<sup>3</sup> international cylinders use hardened steel inserts positioned in critical areas of the cylinder to stand up to drilling, picking and other forms of physical attack.



#### Can Be Master Keyed

Can be master keyed into a system containing Medeco BiLevel and Medeco<sup>3</sup> mechanical as well as M<sup>3</sup> CLIQ eCylinders.

#### Technical Information:

- Utility patented key control provides protection from unauthorized duplication of keys in most countries
- Superior master keying capability to accommodate systems of virtually any size
- Solid brass construction provides high quality and long cylinder life
- Nickel plated pins provide exceptional wear resistance and additional hardened stainless steel pins provide drill resistance
- European profile cylinders retrofit into virtually any manufacturers' locksets requiring DIN Standard cylinders
- Pin chamber set screws provide ease of rekeying and resist comb attacks
- 5 and 6 pin cylinder available

#### Certification:

- SKG \*\*\* Netherlands
- Swedish Standards SS3522
- EN1303 - 2005
- DIN18254

#### Warranty:

Warranted for two (2) years against manufacturer's defects. See the Medeco® limited warranty for full details

#### Available Key Technologies:

##### Mechanical:

- Medeco<sup>3</sup>
- Medeco<sup>3</sup> BiLevel
- Medeco X4

##### eCylinder:

- M<sup>3</sup> CLIQ
- Classic CLIQ
- Medeco XT
- Medeco X4 CLIQ

# EPIC–Euro Profile Interchangeable Core

Medeco EPIC-Euro Profile cylinders are designed to accept a special, slab-sided, small format interchangeable core (SFIC) cylinder to retrofit into most standard European Profile applications.

Medeco Euro profiles can be furnished with Medeco's patented X4 technology, offering unmatched key control, the widest array of retrofit cylinders and four times the master keying capability.



#### Patented Key Control

Protects against unauthorized duplication of your keys.



#### Uses Existing Hardware

European profile cylinders retrofit into virtually any manufacturers' locksets requiring DIN Standard cylinders.



#### Superior Master Keying Capability

Furnished with Medeco X4 SFIC, EPIC offers superior master keying to accommodate very large systems.

### Medeco X4 Technical Information

- 6 and 7 Pin cylinders available
- Solid nickel silver pins
- Many cylinder formats available
- Profile cylinders available in multiple sizes, finishes and functions
- Where interchangeable core is not required, Euro profile cylinders are also available in modular components and assembled standard lengths.
- Solid brass construction provides high quality and long cylinder life
- Solid nickel silver pins and keys
- European Profile Cylinders retrofit into virtually any manufacturers' locksets equivalent to DIN Standards

### Warranty

Warranted for (2) years against manufacturing defects. See Medeco Limited Warranty for full details.

## EPIC–Euro Profile Interchangeable Core

Description	Part Number	Price
<b>6 Pin Part Numbers</b>		
EPIC Euro Double 37.9 mm/37.9mm	2326D21	\$96.50
EPIC Euro Half 37.9mm	2326H01	\$62.90
EPIC Euro with Thumbturn 40mm int/39.2 mm ext	2326S12X*	\$91.10
Small Format Interchangeable Core (SFIC)	3360000R (P)	\$71.20
Small Format Interchangeable Core (SFIC)	3360000R (S)	\$58.20
<b>7 Pin Part Numbers</b>		
EPIC Euro Double 41.73mm/41.73mm	2324D21	\$96.50
EPIC Euro Double 41.73mm/55mm	2324D25	\$96.50
EPIC Euro Half 41.73mm	2324H01	\$62.90
EPIC Euro Half 55mm	2324H05	\$62.90
EPIC with Thumbturn 40mm int/43mm ext	2324S12X	\$91.10
EPIC with Thumbturn 40mm int/55mm ext	2324S15X	\$91.10
EPIC with Thumbturn 55mm int/43mm ext	2324S52X	\$91.10
Small Format Interchangeable Core (SFIC)	3370000R (P)	\$71.20
Small Format Interchangeable Core (SFIC)	3370000R (S)	\$58.20

\* X denotes thumb turn. Please see following page for thumb turn. EPIC sold less cylinder.

\*\*Refer to the eCylinder section for more detail on specific technologies available and pricing. Technologies are represented by the following letters:  
T = Medeco<sup>3</sup>, S = M<sup>3</sup> CLIQ, J = Medeco<sup>3</sup> BiLevel, W = Biaxial, V = Medeco Biaxial CLIQ, K = Medeco KM, N = Medeco X4, C = Classic CLIQ, M = Medeco X4 CLIQ,  
“.” = Original, Z = Medeco Original KW CLIQ, G = Medeco XT \*\*\*See key section for surcharges for custom coined cut keys or special stamping requirements.  
**Note:** (P) refers to **Pinned** and (S) to **Sub-Assembled** at the end of each part string in the price book.

## How To Order International Cylinders - Euro-Profile

<b>1</b> <b>23130 05500</b> <b>base part #</b>  Refer to pages 123-125 for descriptions and technical specifications to find the corresponding base part number.	<b>2</b> <b>T</b> <b>cylinder</b>  – = Original W = BiAxial B = BiLevel T = Medeco <sup>3</sup> J = Medeco <sup>3</sup> BiLevel N = Medeco X4 G = Medeco XT	<b>3</b> <b>05</b> <b>finish</b>  Refer to the inside back cover of this catalog for finish options. Include the corresponding two digit finish number.	<b>4</b> <b>LT</b> <b>keyway</b>  Insert keyway if known or contact Customer Service for help.	<b>5</b> <b>S</b> <b>pinning</b>  <table border="1"> <tr> <td style="vertical-align: top;"> <b>S =</b>  <b>Sub-Assembled (Uncombined)</b>            No additional information needed         </td> <td style="vertical-align: top;"> <b>P =</b>  <b>Pinned (Combinated)</b>            Keyed alike (KA)            Keyed different (KD)            2 keys per cylinder         </td> <td style="vertical-align: top;"> <b>M =</b>  <b>Master Keyed</b>             Provide specific pinning or contact Customer Service for support             Must specify quantity for keys.         </td> </tr> </table>	<b>S =</b> <b>Sub-Assembled (Uncombined)</b> No additional information needed	<b>P =</b> <b>Pinned (Combinated)</b> Keyed alike (KA) Keyed different (KD) 2 keys per cylinder	<b>M =</b> <b>Master Keyed</b>  Provide specific pinning or contact Customer Service for support  Must specify quantity for keys.
<b>S =</b> <b>Sub-Assembled (Uncombined)</b> No additional information needed	<b>P =</b> <b>Pinned (Combinated)</b> Keyed alike (KA) Keyed different (KD) 2 keys per cylinder	<b>M =</b> <b>Master Keyed</b>  Provide specific pinning or contact Customer Service for support  Must specify quantity for keys.					

### BUILD A BASE PART #:

23130 X X X X X X

**International High Security Cylinder**

**Profile Design**

**Function**

- \*0 = Thumbturn Cylinder with "SR" Round Knob
- 1 = Half Cylinder
- 2 = Double Cylinder
- \*3 = Thumbturn Cylinder with Low Profile "LP" Knob
- \*4 = Thumbturn Cylinder with Decorative "RD" Knob
- \*5 = Thumbturn Cylinder with Lever "RL" Knob
- 6 = Thumbturn Cylinder with "CR" Crescent Knob
- 7 = Thumbturn Cylinder with "SP" Spade Knob
- L = Thumbturn Cylinder with "L" Less Knob

**Number of Pins**

- 5 = 5 Pins
- 6 = 6 Pins
- 7 = 7 Pins

**Interior/Exterior Length Extensions**

0 = No Extension	5 = 25 mm (.984")
1 = 5 mm (.197")	6 = 30 mm (1.18")
2 = 10 mm (.394")	7 = 35 mm (1.38")
3 = 15 mm (.591")	8 = 40 mm (1.57")
4 = 20 mm (.787")	9 = 45 mm (1.77")

**Cam Position (from outside with bible down)**

- 1 = 1 o'clock
- 2 = 10 point multi-gear
- 3 = EuroLine Module
- 5 = 5 o'clock
- 7 = 7 o'clock
- 8 = Multiposition (half cylinder only)
- 0 = 11 o'clock

\*Thumbturn/Cam position available at 5 and 11 o'clock only

**Assembly Variation for the BiLevel with Original Technology**

- H = High Security
- B = Standard Security

\*\*Refer to the eCylinder section for more detail on specific technologies available and pricing.

\*\*\*See key section for surcharges for custom coined cut keys or special stamping requirements.

**Note:** (P) refers to **Pinned** and (S) to **Sub-Assembled** at the end of each part string in the price book.

## How To Order Other International Cylinders

Complete part numbers are required for all orders. To determine the correct part number, fill in the “X’s” in sequential order.

<p><b>1</b></p> <p><b>2305016</b> base part #</p> <p>Refer to pages 126-129 for descriptions and technical specifications to find the corresponding base part number.</p>	<p><b>2</b></p> <p><b>T</b> cylinder</p> <p>– = Original W = Biaxial B = BiLevel T = Medeco<sup>3</sup> G = Medeco XT</p>	<p><b>3</b></p> <p><b>05</b> finish</p> <p>Refer to the inside back cover of this catalog for finish options. Include the corresponding two digit finish number.</p>	<p><b>4</b></p> <p><b>LT</b> keyway</p> <p>Insert keyway if known or contact Customer Service for help.</p>	<p><b>5</b></p> <table border="1"> <tr> <td> <p>S = <b>Sub-Assembled</b> (Uncombined) No additional information needed</p> </td> <td> <p>P = <b>Pinned (Combined)</b> Keyed alike (KA) Keyed different (KD) 2 keys per cylinder</p> </td> <td> <p>M = <b>Master Keyed</b> Provide specific pinning or contact Customer Service for support Must specify quantity for keys.</p> </td> </tr> </table>	<p>S = <b>Sub-Assembled</b> (Uncombined) No additional information needed</p>	<p>P = <b>Pinned (Combined)</b> Keyed alike (KA) Keyed different (KD) 2 keys per cylinder</p>	<p>M = <b>Master Keyed</b> Provide specific pinning or contact Customer Service for support Must specify quantity for keys.</p>
<p>S = <b>Sub-Assembled</b> (Uncombined) No additional information needed</p>	<p>P = <b>Pinned (Combined)</b> Keyed alike (KA) Keyed different (KD) 2 keys per cylinder</p>	<p>M = <b>Master Keyed</b> Provide specific pinning or contact Customer Service for support Must specify quantity for keys.</p>					

### BUILD A BASE PART #:

23 XXX XXX X

<p><b>International High Security Cylinder</b></p> <p><b>Design</b></p> <ul style="list-style-type: none"> <li>010 = Danish Round (Ruko Round)</li> <li>030 = Australian Oval</li> <li>040 = British Oval (Union Oval)† No extension.*</li> <li>050 = Scandinavian Oval Ext. (ASSA Oval)</li> <li>060 = Scandinavian Oval Int. (ASSA Oval)</li> <li>070 = Norwegian Oval (TrioVing Oval)</li> <li>080 = Scandinavian Snowman</li> <li>090 = Scandinavian Round Ext. (ASSA Round)</li> <li>100 = Scandinavian Round Int. (ASSA Round)</li> <li>140 = Italian Outer Gate Lock, 3 Pin</li> <li>150 = Italian Outer Gate Lock, 5 Pin</li> <li>160 = Italian Roller Shutter, 4 Pin</li> </ul> <p><b>Function*</b></p> <ul style="list-style-type: none"> <li>0 = Thumbturn Cylinder with “RL” Knob Union Oval only</li> <li>1 = Half Cylinder</li> <li>2 = Double Cylinder</li> </ul>	<p><b>Cam Position (British Oval)*</b></p> <ul style="list-style-type: none"> <li>0 = 11 o'clock</li> <li>1 = 1 o'clock</li> <li>5 = 5 o'clock</li> <li>7 = 7 o'clock</li> </ul> <p><b>BiLevel w/ Original Technology</b></p> <ul style="list-style-type: none"> <li>H = High Security</li> <li>B = Standard Security</li> </ul> <p><b>Number of Pins</b></p> <ul style="list-style-type: none"> <li>3 = 3 Pins</li> <li>4 = 4 Pins</li> <li>5 = 5 Pins</li> <li>6 = 6 Pins</li> </ul>
--	--

† Union Oval Thumbturn Position at 5 and 11 o'clock only.

\* British Oval is the only design that requires a function number and cam position to be selected. It is non-extending.

\*\*Refer to the eCylinder section for more detail on specific technologies available and pricing.

\*\*\*See key section for surcharges for custom coined cut keys or special stamping requirements.

**Note:** (P) refers to **Pinned** and (S) to **Sub-Assembled** at the end of each part string in the price book.

## Medeco Premium High Security Euro Thumbturn Profile Cylinder

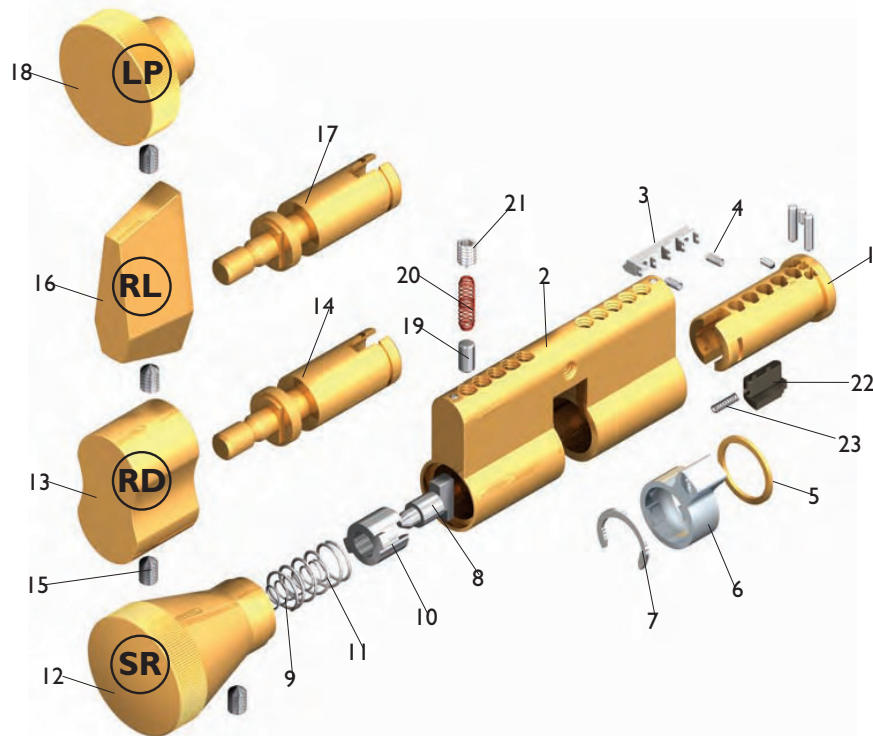

Item	Description	Part Number
1	Plug	Cylinder Specific
2	Shell	Cylinder Specific
3	Sidebar	CP-084X71
4	Sidebar Springs	CP-030018
5	Plug Retainer Ring	CP-021490
6	Cam	CT-Z51
7	Thumbturn Retaining Clip	CP-020031
8	Actuator	CP-100111
9	Actuator Spring	CP-030025
10	Actuator Pilot	CP-280261
11	Pilot Spring	CP-030024
12	Standard Round "SR" Thumbturn	CP-285961
13	Decorative "RD" Thumbturn	CP-285901
14	Thumbturn Shaft - 6 Pin	CP-240761-600
15	Thumbturn Allen Set Screw #6-32 x 3/16" Knurled Cup Point	CP-012411-040
16	Lever "RL" Thumbturn	CP-285931
17	Thumbturn Shaft - 5 Pin	CP-240761-500
18	Low Profile "LP" Thumbturn	CP-285991
19	Thumbturn Retaining Pin	TP-F10-1T
20	Thumbturn Retaining Pin Spring	CP-030001
21	Thumbturn Retaining Pin Allen Set Screw #8-32 x 1/4"	CP-011013-040
22	Slider (varies related to keyway)	CP-084591
23	Slider Spring	CP-030910
24	Spade Thumbturn (Pictured on page 135 "Special Order") "SP"	CP-286051
25	Crescent Thumbturn (Pictured on page 135 "Special Order") "CR"	CP-286021

### Medeco Premium High Security Euro Half Profile Cylinder

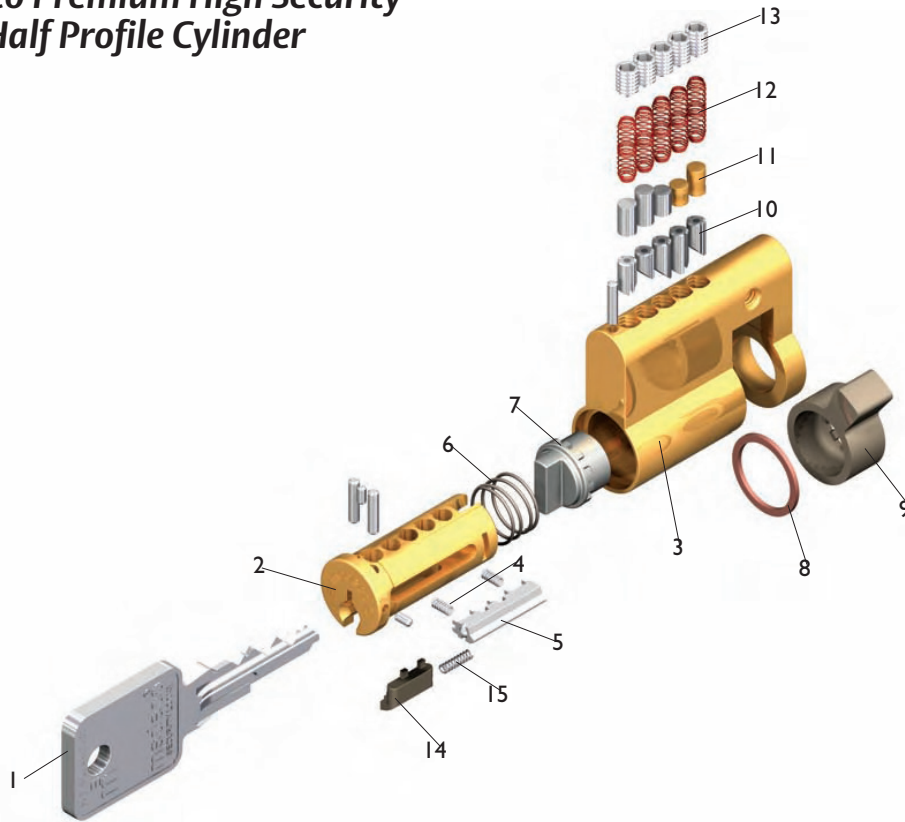

Item	Description	Part Number
1	Key	As Required
2	Plug	Cylinder Specific
3	Shell	Cylinder Specific
4	Sidebar Springs	CP-030018
5	Sidebar	CP-084X71
6	Cam Spring	CP-030860
7	Actuator	CP-220090
8	Plug Retainer	CP-021490
9	Cam	CT-Z88
10	Bottom Pins	As Required
11	Top Pins	As Required
12	Springs (Phosphor Bronze)	CP-030001
13	Pin Chamber Allen Set Screws #8-32 x 1/4"	CP-011013-040
14	Slider – (varies related to keyway)	CP-084591
15	Slider Spring	CP-030910



## Medeco Premium High Security Exterior Scandinavian Oval Cylinder

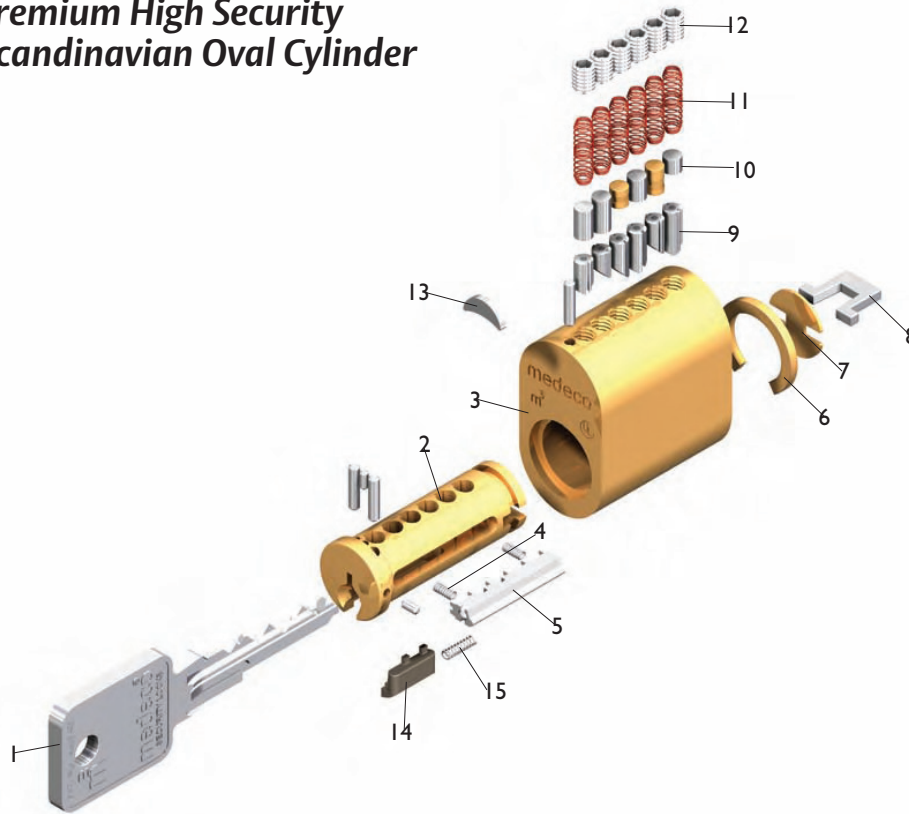

Item	Description	Part Number
1	Key	As Required
2	Plug	Cylinder Specific
3	Shell	Cylinder Specific
4	Sidebar Springs	CP-030018
5	Sidebar, 6 Pin	CP-084671
6	Plug Retainer	CP-021040
7	Plate	CP-180830
8	Tailpiece	CT-Y76
9	Bottom Pins	As Required
10	Top Pins	As Required
11	Springs (Phosphor Bronze)	CP-030001
12	Pin Chamber Allen Set Screws #8-32 x 1/4"	CP-011013-040
13	Crescent Steel Insert	CP-180011
14	Slider – (varies related to keyway)	CP-084591
15	Slider Spring	CP-030910

### Medeco Premium High Security Interior Scandinavian Oval Cylinder

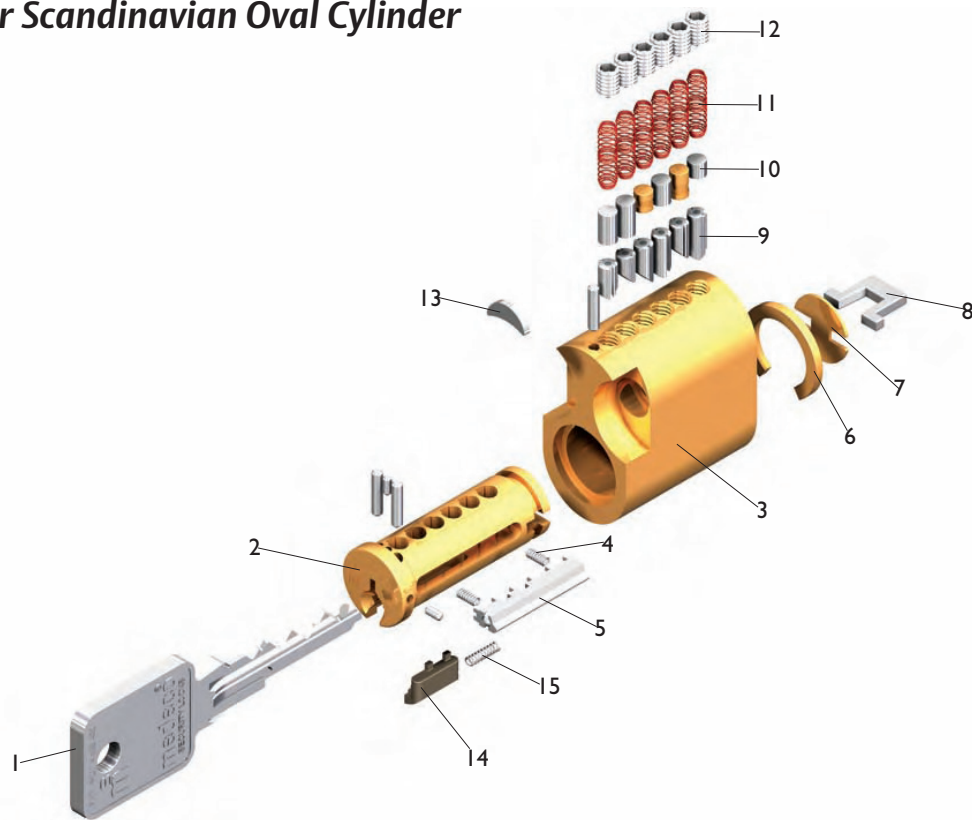

Item	Description	Part Number
1	Key	As Required
2	Plug	Cylinder Specific
3	Shell	Cylinder Specific
4	Sidebar Springs	CP-030018
5	Sidebar, 6 Pin	CP-084671
6	Plug Retainer	CP-021040
7	Plate	CP-180830
8	Tailpiece	CT-Y76
9	Bottom Pins	As Required
10	Top Pins	As Required
11	Springs (Phosphor Bronze)	CP-030001
12	Pin Chamber Allen Set Screws #8-32 x 1/4"	CP-011013-040
13	Crescent Steel Inserts	CP-180011
14	Slider – (varies related to keyway)	CP-084591
15	Slider Spring	CP-030910

## Medeco Premium High Security Euro Double Profile

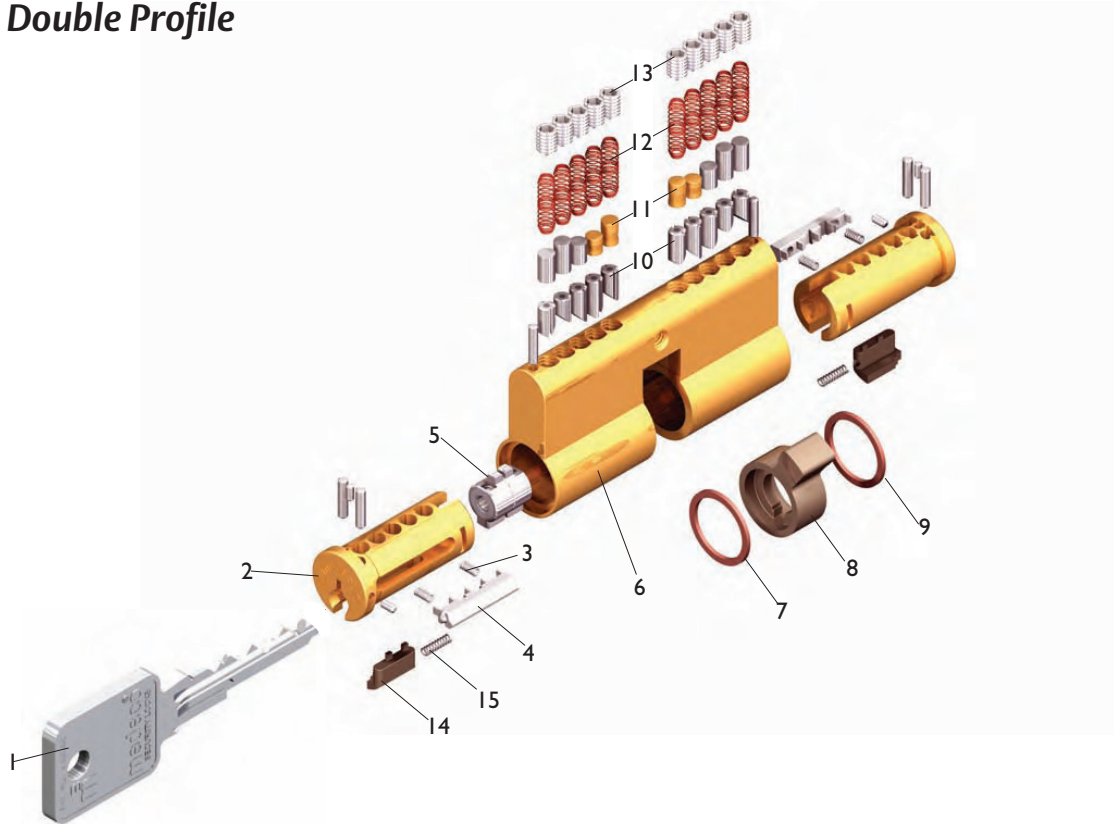

Item	Description	Part Number
1	Key	As Required
2	Plug	Cylinder Specific
3	Sidebar Springs	CP-030018
4	Sidebar, 5 Pin	CP-084571
5	Clutch	CP-220071
6	Shell	Cylinder Specific
7	Plug Retainer	CP-021490
8	Cam	CT-Z50
9	Plug Retainer	CP-021490
10	Bottom Pins	As Required
11	Top Pins	As Required
12	Springs (Phosphor Bronze)	CP-030001
13	Pin Chamber Allen Set Screws #8-32 x 1/4"	CP-0110113-040
14	Slider - (varies related to keyway)	CP-084591
15	Slider Spring	CP-030910

**Medeco Premium High Security  
EuroLine Modular Profile Cylinder System**

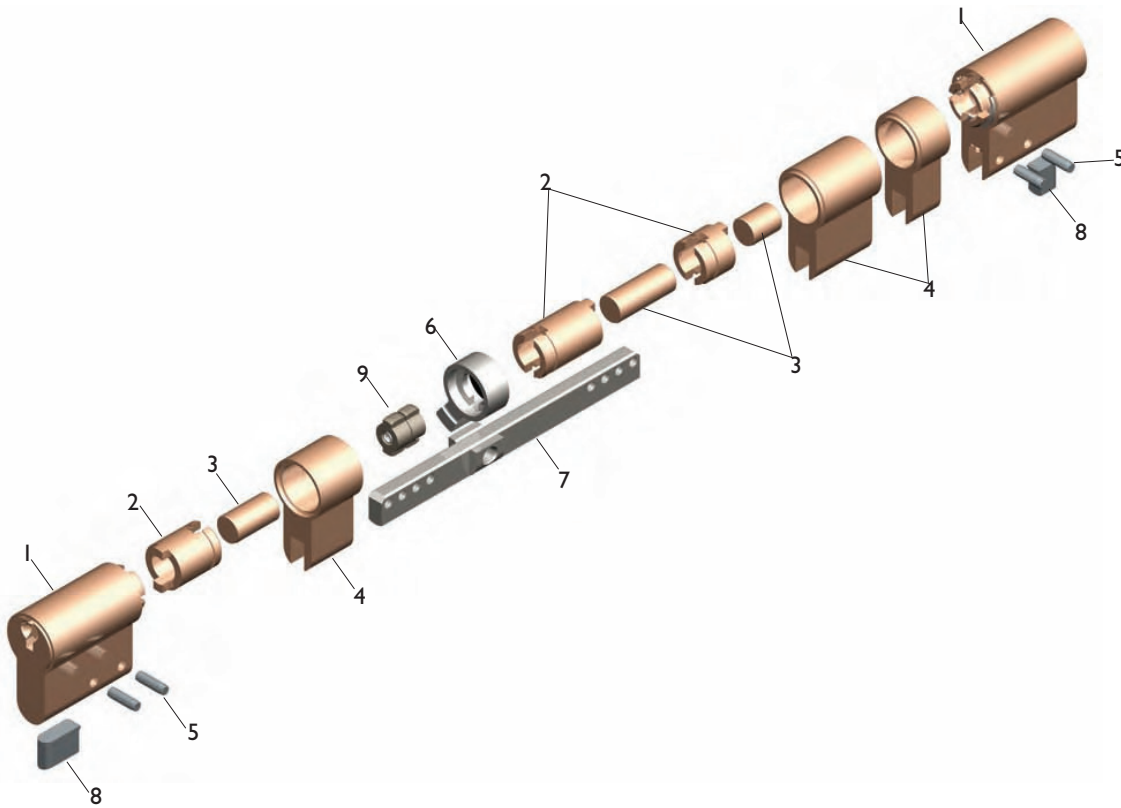

**Modular Profile Double Cylinder**

Item	Description	Part Number
1	Cylinder Module (5 or 6 Pin)	232201X 30X
2	Outer Plug Extension - 10mm – 25mm extensions available	CP-200751
3	Inner Plug Extension - 5mm – 25mm extensions available	CP-200761
4	Brass Shell Extension - finish required	CP-200771
5	Groove Pins	CP-063220
6	Cam	CT-Z50
7	Connecting Bar - requires length designation	CP-200801
8	Bar Filler	CP-160661
9	Clutch Assembly	CP-220071

## Medeco Premium High Security EuroLine Modular Profile Cylinder System

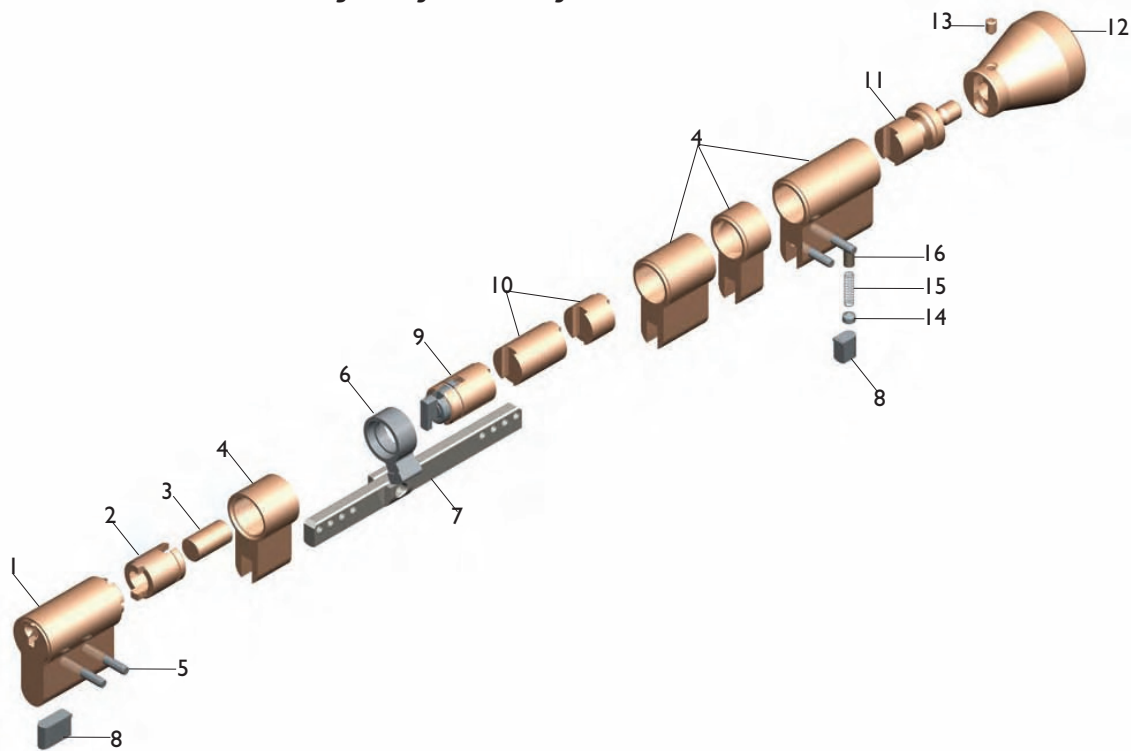

### Modular Profile Single Cylinder with Thumbturn

Item	Description	Part Number
1	Thumbturn Cylinder Module (5 or 6 pin), requires knob selection	23X220XX-300
2	Outer Plug Extension, 10-25 mm extension	CP-200751
3	Inner Plug Extension, 5-25 mm extension	CP-200761
4	Brass Shell Extension, Finish required	CP-200771
5	Groove Pins	CP-063220
6	Cam	CP-Z51
7	Connecting Bar	CP-200801
8	Bar Filler	CP-160661
9	Thumbturn Actuator Cartridge	CP-220131
10	Thumbturn Cartridge Extension, 5-25 mm extension	CP-200781
11	Thumbturn Shaft – Modular Only	CP-240771-XP
12	Thumbturn Knob	See Page 135
13	Thumbturn Set Screw	CP-011013-020
14	Thumbturn Retaining Set Screw 8- 32 x 1/4"	CP-011013-040
15	Thumbturn Retaining Pin Spring	CP-030001
16	Thumbturn Retaining Pin	TP-F10-IT

**Euro Profile Technical Information**

A = Total Length	C = Exterior Length
B = Interior Length	KP = Knob to Face

**EURO PROFILE SINGLE CYLINDER WITH THUMBTURN**

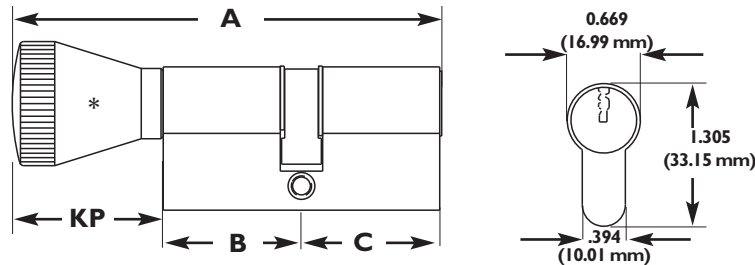

**Euro Profile Single Cylinder with Thumbturn**

Part#	A	B	C	KP
2313005 X00 *	99.04	31.98	31.98	35.08
2313035 X00	81.44	31.98	31.98	17.48
2313045 X00	83.09	31.98	31.98	19.13
2313055 X00	84.1	31.98	31.98	20.14
2313006 X00 *	107.68	36.3	36.3	35.08
2313036 X00	90.08	36.3	36.3	17.48
2313046 X00	91.73	36.3	36.3	19.13
2313056 X00	92.74	36.3	36.3	20.14
2313065 X00 (490264)	84.3	31.98	31.98	20.35
2313066 X00 (490291)	92.94	36.3	36.3	20.35

**Euro Profile Technical Information**

A = Total Length	C = Exterior Length
B = Interior Length	

**EURO PROFILE DOUBLE CYLINDER**

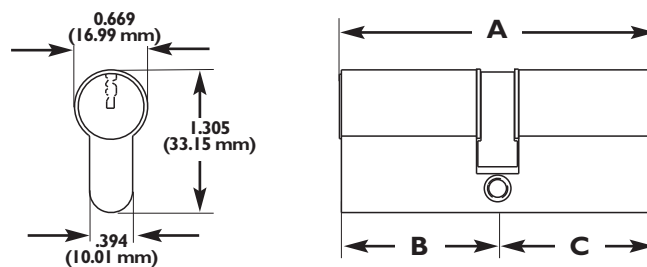

**Euro Profile Double Cylinder with Thumbturn**

Part#	A	B	C
2313025 X00	63.96	31.98	31.98
2313026 X00	72.59	36.3	36.3
2313025 X01	68.96	31.98	36.98
2313025 X02	73.96	31.98	41.99
2313025 X11	73.96	36.98	36.98
2313025 X12	78.97	36.98	41.99
2313026 X01	77.6	36.3	41.3
2313026 X02	82.6	36.3	46.3
2313026 X12	87.6	41.3	46.3

All table measurements in millimeters.

**Euro Profile Technical Information**

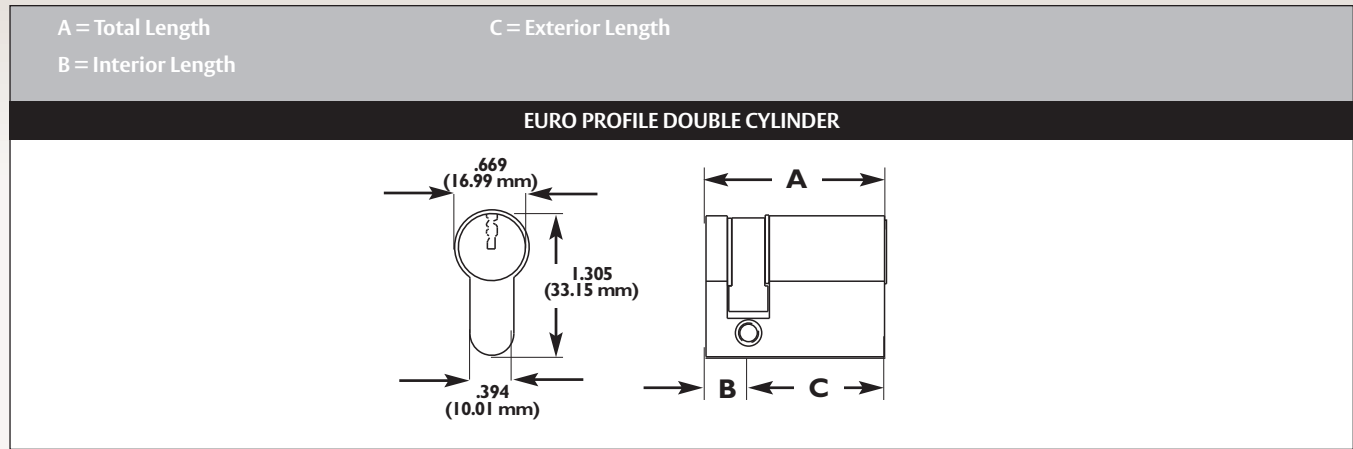

**Euro Profile Single Cylinder with Thumbturn**

Part#	A	B	C
2313015 800	41.99	10.01	31.98
2313016 800	46.4	10.01	36.3
2313015 801	46.99	10.01	36.98
2313016 801	51.31	10.01	41.3

All table measurements in millimeters.

**Euro Profile Technical Information**

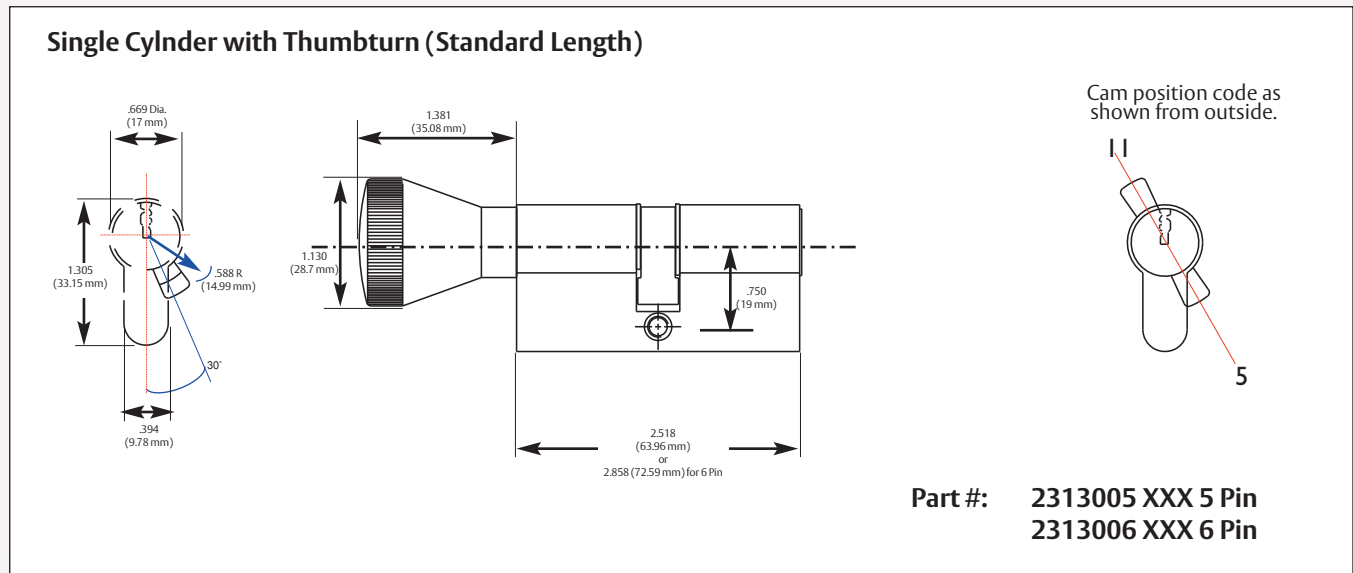



### Half Cylinder (Standard Length)

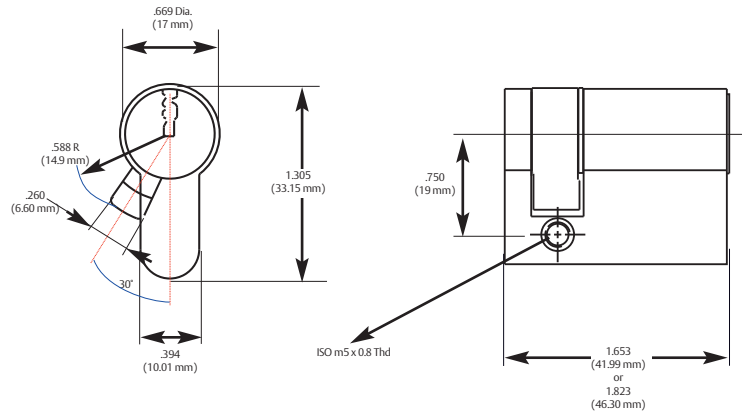

Cam position code as shown from outside.

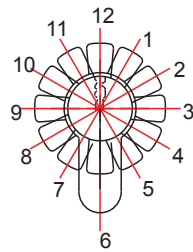

Multi-indexing cam with 12 positions. Cam is set at 5 o'clock from the factory

**Part #:** 2313015 8XX 5 Pin  
2313016 8XX 6 Pin

### Double Cylinder 5 Pin (Standard and Extended)

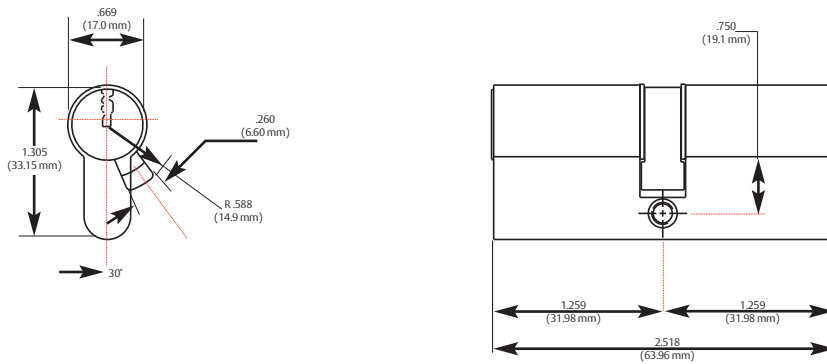

Cam position code as shown from outside.

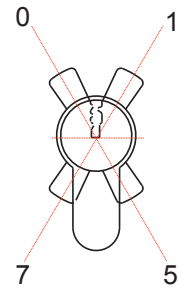

**Part #:** 2313025 X00 5 Pin  
In 5mm steps up to 45mm

### Double Cylinder 6 Pin (Standard and Extended)

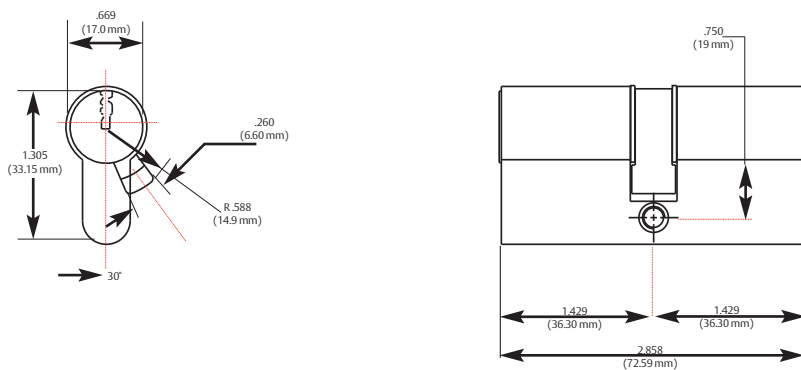

Cam position code as shown from outside.

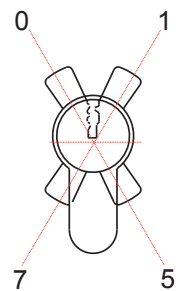

**Part #:** 2313026 X00 6 Pin  
In 5mm steps up to 45mm

### Union Single with Thumbturn

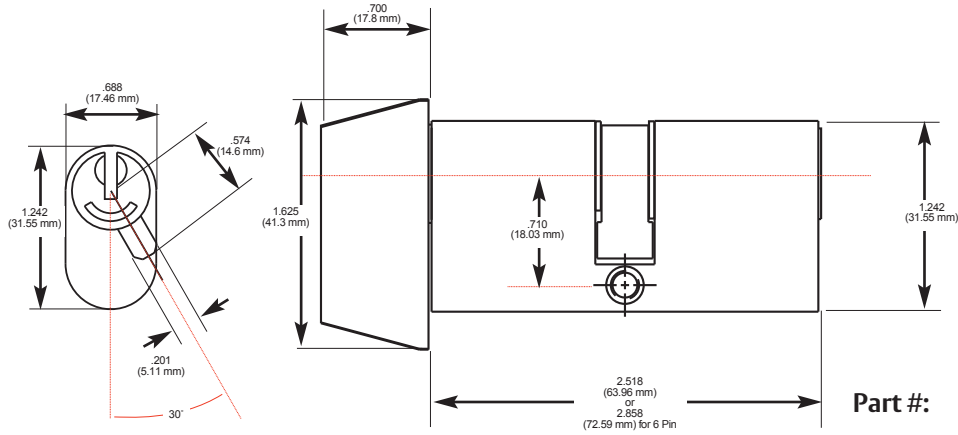

Cam position code as shown from outside.

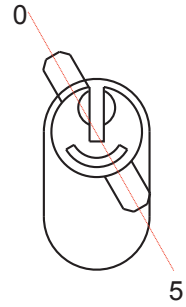

**Part #:** 2304005 X00 5 Pin  
2304006 X00 6 Pin

### Union Half Cylinder

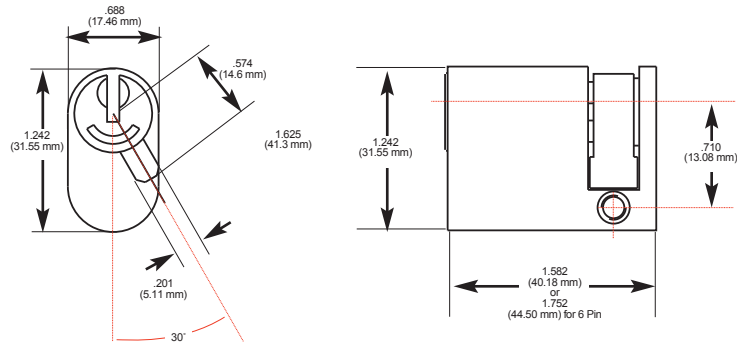

Cam position code as shown from outside.

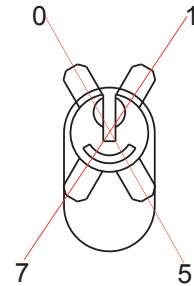

**Part #:** 2304015 X00 5 Pin  
2304016 X00 6 Pin

### Union Double Cylinder

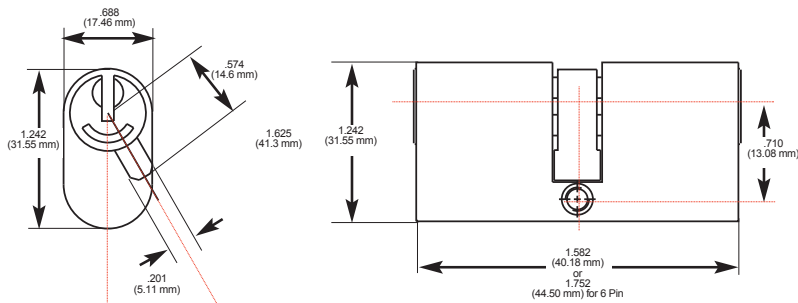

Cam position code as shown from outside.

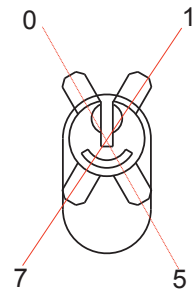

**Part #:** 2304025 X00 5 Pin  
2304026 X00 6 Pin

**Scandinavian Oval – Exterior for ASSA/Ruko®**

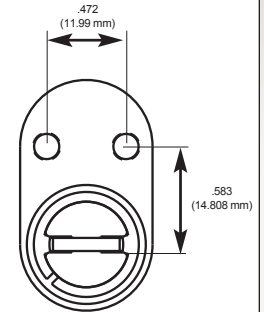
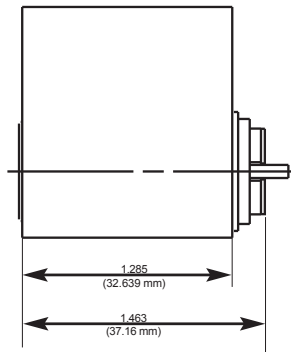
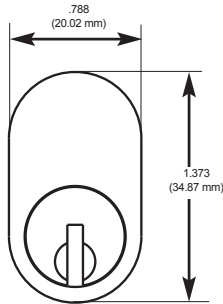

Tailpiece CT-Y76

Part #: 2305016 6 Pin

**Scandinavian Oval – Interior for ASSA/Ruko®**

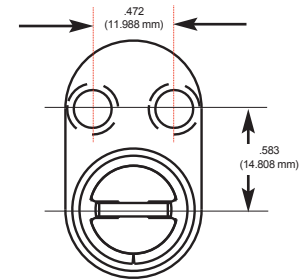
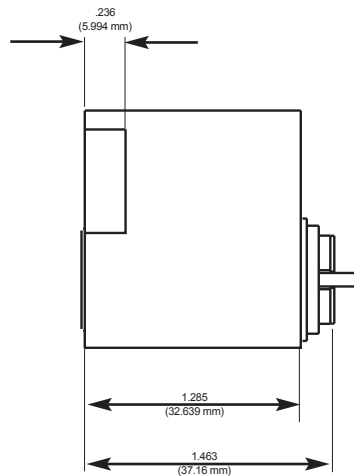
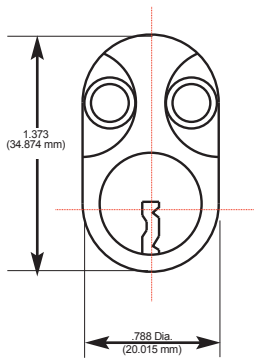

Tailpiece CT-Y76

Part #: 2306016 6 Pin

**Scandinavian Padlock – for ASSA/Ruko®**

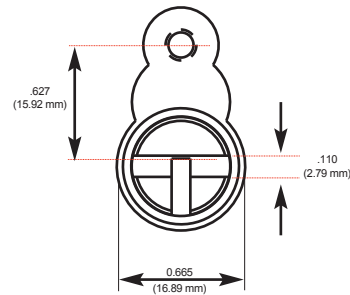
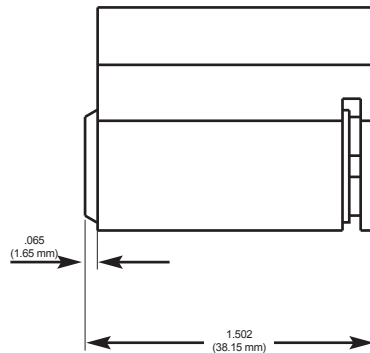
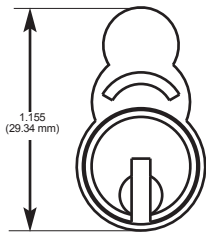

Part #: 2308016X 6 Pin

**Scandinavian Round Exterior – for ASSA/Ruko®**

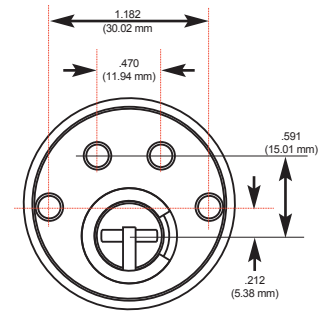
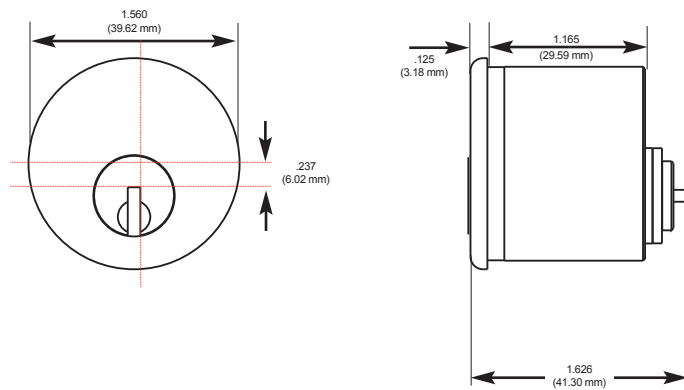

**Part #: 2309016 6 Pin**

**Scandinavian Round Interior – for ASSA/Ruko®**

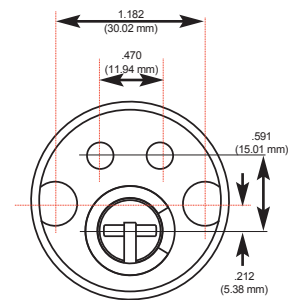
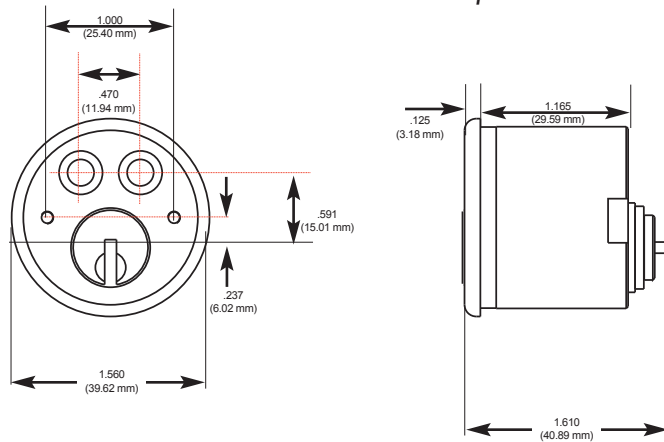

**Part #: 2310016 6 Pin**

**Danish Round – Exterior for Ruko®**

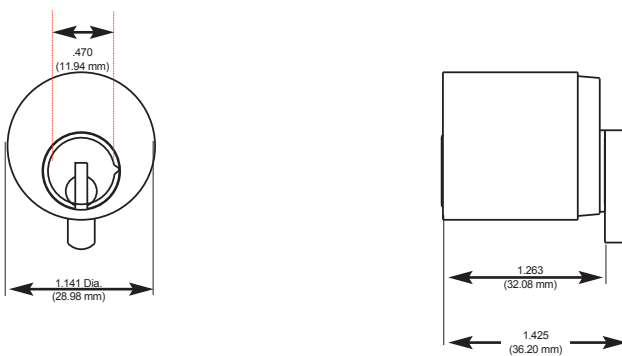

Special pinning required due to chamber height

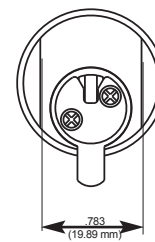

**Part #: 2301016 6 Pin**

### Norwegian Single Cylinder for Trio Ving®

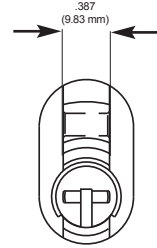
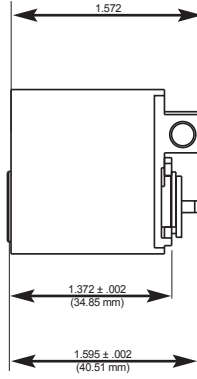
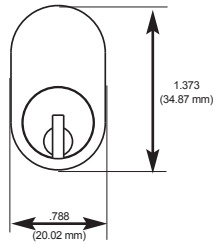

Part #: 23070165 6 Pin

## Euroline Modular Profile Kit

Description	Part Number	Price
Euroline Modular Profile Kit - Danish	940243	\$4,782.00
Medeco XT Half Profile Modular Kit	940279	\$3,125.00
Euro Single/Double Thumbturn Kit Mechanical/Electric Available in Medeco XT or M <sup>3</sup> CLIQ	940219	\$5,047.00
Export Demo Kit (Programmed to STOCK)	94-0287	\$743.00 NET
Upgrade Key Assembly Solo	94-0288	\$187.00 NET
Upgrade Key Assembly Web	94-0289	\$187.00 NET
Medeco XT Cam for Doubles – Not included in kit	CT-Z98	\$4.00

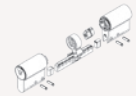

## Euroline Modular Cylinder Assembled

Description	Part Number	M <sup>3</sup>	X4	Biax/Orig
5 Pin Double Cylinder	2323025 X00	\$161.00		\$166.63
6 Pin Double Cylinder	2323026 X00	\$171.20		\$176.83
5 Pin Double Thumbturn/Cylinder	23230X5 X00	\$147.00		\$152.63
6 Pin Double Thumbturn/Cylinder	23230X6 X00	\$154.50		\$160.13
7 Pin X4 Euro Assembly ext. 0mm Thumbturn	23230X7 500		\$147.00	
7 Pin X4 Euro Assembly ext. 5mm Thumbturn	23230X7 511		\$155.00	

## Euroline Modular eCylinder Assembled

Description	Part Number	Price
M <sup>3</sup> CLIQ, Thumbturn/Cylinder, 36/36mm	23230X6 X00 S	\$627.00
M <sup>3</sup> CLIQ Double, 36/36mm	23230E6 X00 S	\$667.00
Medeco XT Single Cylinder Half Euro	232301S 800 G	\$262.00
Medeco XT Single Cylinder Half Euro – ext. 5mm	232301S 801 G	\$266.00
Medeco XT Single Cylinder Half Euro Assembled (True 30mm)	232301ST 800 G	\$262.00
Medeco XT Single Cylinder Euro Thumbturn 30/30mm Assembled	23230XS X00 G	\$291.00
Medeco XT Single Cylinder Euro Thumbturn 35/35mm Assembled	23230XS X11 G	\$299.00
Medeco XT Double Euro Mechanical/eCyl 30/30mm Assembled	23230E5 X00 G	\$344.00
Medeco XT Double Euro Mechanical/eCyl 35/35mm Assembled	23230E5 X11 G	\$352.00
Special Pin Kit for Biaxial/Medeco <sup>3</sup> CLIQ Pinning	.KW5401	\$685.00

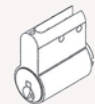

## EuroLine Profile Cylinder Modules

Description	Part Number	M <sup>3</sup>	X4	Biax/Orig
5 Pin Cylinder	2322015 300	\$52.00		\$53.64
5 Pin Cylinder + 5mm	2322015 301	\$56.00		\$57.64
6 Pin Cylinder	2322016 300	\$56.80		\$58.44
6 Pin Cylinder + 5mm	2322016 301	\$60.80		\$62.44
Medeco x4 Standard 7 Pin Cylinder (35.59mm)	2322017 300 N		\$30.90	
Medeco x4 7 Pin + 5mm Cylinder (40.59mm)	2322017 301 N		\$34.90	

Note: Pinned Modules include one cut key in the price.

\*\*Refer to the eCylinder section for more detail on specific technologies available and pricing. Technologies are represented by the following letters:  
 T = Medeco<sup>3</sup>, S = M<sup>3</sup> CLIQ, J = Medeco<sup>3</sup> BiLevel, W = Biaxial, V = Medeco Biaxial CLIQ, K = Medeco KM, N = Medeco X4, C = Classic CLIQ, M = Medeco X4 CLIQ,  
 “. ” = Original, Z = Medeco Original KW CLIQ, G = Medeco XT \*\*\*See key section for surcharges for custom coined cut keys or special stamping requirements.  
 Note: (P) refers to Pinned and (S) to Sub-Assembled at the end of each part string in the price book.

**Euroline eCylinder Profile Medeco XT Modules**

Description	Part Number	Price
Medeco XT 30mm Single Cylinder Half Euro	232201S 300 G	\$220.00
Medeco XT 35mm Single Cylinder Half Euro	232201S 301 G	\$224.00
Medeco XT 40mm-85mm Single Cylinder Half Euro	232201S 302 G	\$220.00
Medeco XT 30mm Single Cylinder Thumbturn	232202S 300 G	\$220.00
Medeco XT 35mm Single Cylinder Thumbturn	232202S 301 G	\$224.00
Medeco XT 40mm-85mm Single Cylinder Thumbturn	232202S 302 G	\$220.00
Medeco XT 30mm Double Cylinder	232212SX 300 G	\$220.00
Medeco XT 35 mm Double Cylinder	232212SX 301 G	\$224.00
Medeco XT 40mm-85mm Double Cylinder	232222SX 302 G	\$228.00

**Euroline eCylinder Profile Medeco<sup>3</sup> CLIQ Modules**

Description	Part Number	Price
M <sup>3</sup> CLIQ, 6 pin Module	2322016 300 S	\$557.00
M <sup>3</sup> CLIQ 6 pin + 5mm	2322016 301 S	\$561.00

**EuroLine Profile Thumbturn Modules**

Description	Part Number	Price
5 Pin Thumbturn	23220X5 300	\$51.80
6 Pin Thumbturn	23220X6 300	\$56.00
5 Pin X4 Thumbturn Module	23220X5 302	\$59.80

**Euroline Profile Medeco XT Thumbturn Modules**

Description	Part Number	Price
Euro Thumbturn Module - 30mm	23220XS 300	\$52.50

To order the Euro Thumbturn Module 35mm, you must add the shell ext. CP20071-05 and cart ext. CP-200781-05 to the 30mm Module

**Special Cylinders**

Description	Part Number	Price
Lockwood Oval retrofit AUS 570 Style	230301S G	\$253.00
KIK AUS 530 Style	201006 G	\$277.00
3-Tailpieces – For Australia Package	94-0283	\$24.10
Medeco XT Ruko Oval	230501S G	\$272.00
Medeco XT AUS 8221 PD Style	20112B1 G	\$277.00

\*\*Refer to the eCylinder section for more detail on specific technologies available and pricing. Technologies are represented by the following letters:  
 T = Medeco<sup>3</sup>, S = M<sup>3</sup> CLIQ, J = Medeco<sup>3</sup> BiLevel, W = Biaxial, V = Medeco Biaxial CLIQ, K = Medeco KM, N = Medeco X4, C = Classic CLIQ, M = Medeco X4 CLIQ,  
 “.” = Original, Z = Medeco Original KW CLIQ, G = Medeco XT \*\*\*See key section for surcharges for custom coined cut keys or special stamping requirements.  
**Note: (P)** refers to **Pinned** and **(S)** to **Sub-Assembled** at the end of each part string in the price book.



## Plug Extensions – Outer

\*Quantities shown in parentheses below are included in the 94-0219 Euroline modular profile kit listed above. Additional items may be ordered individually.

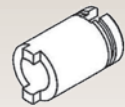

Description	Part Number	Price
10mm Kit Qty (20)	CP-200751-10	\$4.80
15mm Kit Qty (10)	CP-200751-15	\$5.30
20mm Kit Qty (5)	CP-200751-20	\$5.60
25mm Kit Qty (5)	CP-200751-25	\$6.80
30mm	CP-200751-30	\$7.20
40mm	CP-200751-40	\$7.90
45mm	CP-200751-45	\$8.20
50mm	CP-200751-50	\$9.30
55mm	CP-200751-55	\$9.70
60mm	CP-200751-60	\$10.10
65mm	CP-200751-65	\$10.50
70mm	CP-200751-70	\$11.10
75mm	CP-200751-75	\$11.20
80mm	CP-200751-80	\$11.70
85mm	CP-200751-85	\$12.30
90mm	CP-200751-90	\$12.90

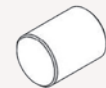

## Plug Extensions – Inner

Description	Part Number	Price
5mm Kit Qty (20)	CP-200761-05	\$3.10
10mm Kit Qty (20)	CP-200761-10	\$3.40
15mm Kit Qty (10)	CP-200761-15	\$3.90
20mm Kit Qty (5)	CP-200761-20	\$4.30
25mm Kit Qty (5)	CP-200761-25	\$5.30
30mm	CP-200761-30	\$5.60
40mm	CP-200761-40	\$6.40
45mm	CP-200761-45	\$7.60
50mm	CP-200761-50	\$7.90
55mm	CP-200761-55	\$8.20
60mm	CP-200761-60	\$9.00
65mm	CP-200761-65	\$9.30
70mm	CP-200761-70	\$12.90
75mm	CP-200761-75	\$12.90
80mm	CP-200761-80	\$13.50
85mm	CP-200761-85	\$14.00
90mm	CP-200761-90	\$14.00

\*\*Refer to the eCylinder section for more detail on specific technologies available and pricing. Technologies are represented by the following letters:  
 T = Medeco<sup>3</sup>, S = M<sup>3</sup> CLIQ, J = Medeco<sup>3</sup> BiLevel, W = Biaxial, V = Medeco Biaxial CLIQ, K = Medeco KM, N = Medeco X4, C = Classic CLIQ, M = Medeco X4 CLIQ,  
 “. ” = Original, Z = Medeco Original KW CLIQ, G = Medeco XT \*\*\*See key section for surcharges for custom coined cut keys or special stamping requirements.  
**Note:** (P) refers to **Pinned** and (S) to **Sub-Assembled** at the end of each part string in the price book.

## Plug Extensions - Double EAC/EAC

Description	Part Number	Price
10mm	CP-200851-10	\$11.60
15mm	CP-200851-15	\$11.90
20mm	CP-200851-20	\$12.30
25mm	CP-200851-25	\$13.40
30mm	CP-200851-30	\$13.70
40mm	CP-200851-40	\$14.30
45mm	CP-200851-45	\$14.60
50mm	CP-200851-50	\$14.90
55mm	CP-200851-55	\$15.20
60mm	CP-200851-60	\$15.80
65mm	CP-200851-65	\$16.10
70mm	CP-200851-70	\$16.40
75mm	CP-200851-75	\$16.70
80mm	CP-200851-80	\$17.00
85mm	CP-200851-85	\$17.30
90mm	CP-200851-90	\$17.60



## Brass Shell Extensions

Description	Part Number	Price
5mm Kit Qty (20)	CP-200771-05	\$6.60
10mm Kit Qty (20)	CP-200771-10	\$7.60
15mm Kit Qty (10)	CP-200771-15	\$8.80
20mm Kit Qty (5)	CP-200771-20	\$10.00
25mm Kit Qty (5)	CP-200771-25	\$11.00

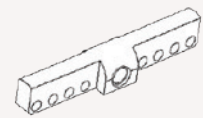

## Connecting Bar

Description	Part Number	Price
5mm Kit Qty (15)	CP-200801-00	\$26.30
10mm Kit Qty (5)	CP-200801-02	\$28.50
20mm Kit Qty (5)	CP-200801-04	\$30.30
30mm Kit Qty (5)	CP-200801-06	\$31.80
40mm Kit Qty (1)	CP-200801-08	\$33.60
50mm Kit Qty (1)	CP-200801-0A	\$35.80
10/10mm Kit Qty (5)	CP-200801-22	\$30.30
10/20mm Kit Qty (5)	CP-200801-24	\$31.80
10/30mm Kit Qty (3)	CP-200801-26	\$33.60
10/40mm Kit Qty (1)	CP-200801-28	\$35.80
10/50mm Kit Qty (1)	CP-200801-2A	\$38.10
20/20mm Kit Qty (3)	CP-200801-44	\$33.60
20/30mm Kit Qty (1)	CP-200801-46	\$35.80
20/40mm Kit Qty (1)	CP-200801-48	\$38.10
20/50mm Kit Qty (1)	CP-200801-4A	\$40.30
30/30mm Kit Qty (1)	CP-200801-66	\$38.10
30/40mm Kit Qty (1)	CP-200801-68	\$40.30
30/50mm Kit Qty (1)	CP-200801-6A	\$42.00
40/40mm Kit Qty (1)	CP-200801-88	\$42.00
40/50mm Kit Qty (1)	CP-200801-8A	\$43.70
50/50mm Kit Qty (1)	CP-200801-AA	\$46.50

\*\*Refer to the eCylinder section for more detail on specific technologies available and pricing. Technologies are represented by the following letters:  
 T = Medeco<sup>3</sup>, S = M<sup>3</sup> CLIQ, J = Medeco<sup>3</sup> BiLevel, W = Biaxial, V = Medeco Biaxial CLIQ, K = Medeco KM, N = Medeco X4, C = Classic CLIQ, M = Medeco X4 CLIQ,  
 ". " = Original, Z = Medeco Original KW CLIQ, G = Medeco XT \*\*\*See key section for surcharges for custom coined cut keys or special stamping requirements.

**Note:** (P) refers to **Pinned** and (S) to **Sub-Assembled** at the end of each part string in the price book.



### Modular Thumbturn Shaft

Description	Part Number	Price
5 Pin Kit Qty (2)	CP-240771-5P	\$9.40
6 Pin Kit Qty (2)	CP-240771-6P	\$9.70



### Modular Service Tools

Description	Part Number	Price
Modular Assembly Block Kit Qty (1)	94-0208	\$946.00
Pinning Block Kit Qty (2)	94-0203	\$9.60
Pinning Block Medeco X4	94-0285	\$9.60
Capping Tool Kit Qty (2)	94-0207	\$1.80
Small flat blade screwdriver Kit Qty (1)	94-0221	\$43.70
Removing Punch, 2.3 mm Kit Qty (1)	94-0222	\$131.00
Installing punch, 6.35 mm Kit Qty (1)	94-0223	\$131.00
Allen Wrench, 1.588 mm Kit Qty (1)	CP-280330	\$3.00

### Miscellaneous Components







Description	Part Number	Price
Groove Pin Kit Qty (200)	CP-063220	\$0.56
Clutch Piece Assembly Kit Qty (20)	CP-220071	\$7.40
5 Pin Cover Kit Qty (100)	CP-170730-5	\$0.57
6 Pin Cover Kit Qty (100)	CP-170730-6	\$0.57
Double Cam Kit Qty (20)	CT-Z50	\$4.00
Thumbturn Cam Kit Qty (20)	CT-Z51	\$4.00

\*\*Refer to the eCylinder section for more detail on specific technologies available and pricing. Technologies are represented by the following letters:  
 T = Medeco<sup>3</sup>, S = M<sup>3</sup> CLIQ, J = Medeco<sup>3</sup> BiLevel, W = Biaxial, V = Medeco Biaxial CLIQ, K = Medeco KM, N = Medeco X4, C = Classic CLIQ, M = Medeco X4 CLIQ,  
 “.” = Original, Z = Medeco Original KW CLIQ, G = Medeco XT \*\*\*See key section for surcharges for custom coined cut keys or special stamping requirements.  
**Note:** (P) refers to **Pinned** and (S) to **Sub-Assembled** at the end of each part string in the price book.

## Top Pins

Description	Part Number
1 top pin Kit Qty (200)	TP-F10-4T (.180")
2 top pin Kit Qty (200)	TP-F10-5T (.150")
3 top pin Kit Qty (200)	TP-H10-9W (.135")
4 top pin Kit Qty (200)	TP-F10-4W-6T (.120")
5 top pin Kit Qty (200)	TP-F10-3W (.090")
6 top pin Kit qty (200)	TP-F10-2W (.060")

## Thumbturn Knobs

Description	Part Number	Price
 Decorative "RD" 4	CP-285901	\$17.30
 Lever "RL" 5	CP-285931	\$25.80
 Round "SR" 0	CP-285961	\$25.80
 Low Profile "LP" 3	CP-285991	\$17.30
 Crescent "CR" 6	CP-286021	\$13.50
 Spade "SP" 7	CP-286051	\$13.50

Finish required.

## Thumbturn Assembly - Shaft, Knob, Set Screw - 5 pin

Description	Part Number	Price
Decorative	CP-285921-500	\$52.10
Lever	CP-285951-500	\$77.90
Standard Round	CP-285981-500	\$77.90
Low Profile	CP-286011-500	\$52.10
Crescent	CP-286041-500	\$24.10
Spade	CP-286071-500	\$52.10
Less TT Knob	CP-240761-500	\$23.00

\*\*Refer to the eCylinder section for more detail on specific technologies available and pricing. Technologies are represented by the following letters:  
 T = Medeco<sup>3</sup>, S = M<sup>3</sup> CLIQ, J = Medeco<sup>3</sup> BiLevel, W = Biaxial, V = Medeco Biaxial CLIQ, K = Medeco KM, N = Medeco X4, C = Classic CLIQ, M = Medeco X4 CLIQ,  
 ". " = Original, Z = Medeco Original KW CLIQ, G = Medeco XT \*\*\*See key section for surcharges for custom coined cut keys or special stamping requirements.  
**Note: (P)** refers to **Pinned** and **(S)** to **Sub-Assembled** at the end of each part string in the price book.

## Medeco XT Half Cylinder Connecting Bar

\*Quantities shown in parentheses below are included in the 94-0279 Euroline half cylinder kit listed above. Additional items may be ordered individually.

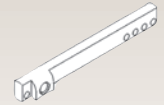

Description	Part Number	Price
40, 45mm Kit Qty (6)	CP-200801-12	\$22.40
50, 55mm Kit Qty (5)	CP-200801-14	\$24.60
60, 65mm Kit Qty (3)	CP-200801-16	\$26.30
70, 75mm Kit Qty (3)	CP-200801-18	\$28.50
80, 85 mm Kit Qty (3)	CP-200801-1A	\$30.30



## Plug Extensions Outer for 94-0279

Description	Part Number	Price
10mm Kit Qty (20)	CP-200751-10	\$4.80
15mm Kit Qty (15)	CP-200751-15	\$5.30
20mm Kit Qty (5)	CP-200751-20	\$5.60
25mm Kit Qty (5)	CP-200751-25	\$6.80

## Brass Shell Extensions for 94-0279

Description	Part Number	Price
5mm Kit Qty (20)	CP-200771-05	\$6.60
10mm Kit Qty (20)	CP-200771-10	\$7.60
15mm Kit Qty (10)	CP-200771-15	\$8.80
20mm Kit Qty (5)	CP-200771-20	\$10.00
25mm Kit Qty (5)	CP-200771-25	\$11.00

## Bar Filler (2 per Cylinder) for 94-0279

Description	Part Number	Price
5 Pin, 0mm Kit Qty (20)	CP-160661-50	\$1.10
5 Pin, 5mm Kit Qty (20)	CP-160661-55	\$1.10

## Miscellaneous Components for 94-0279

Description	Part Number	Price
Half Shell Backend Kit Qty (20)	CP-200830	\$16.30
Actuator Spring Kit Qty (25)	CP-030860	\$1.00
Indexable Actuator Kit Qty (20)	CP-220090	\$4.50
Security Pin Kit Qty (25)	CP-060106	\$1.10
Groove Pin Kit Qty (65)	CP-063220	\$0.56
Indexable Cam	CT-Z88	\$4.00

\*\*Refer to the eCylinder section for more detail on specific technologies available and pricing. Technologies are represented by the following letters:  
 T = Medeco<sup>3</sup>, S = M<sup>3</sup> CLIQ, J = Medeco<sup>3</sup> BiLevel, W = Biaxial, V = Medeco Biaxial CLIQ, K = Medeco KM, N = Medeco X4, C = Classic CLIQ, M = Medeco X4 CLIQ,  
 “. ” = Original, Z = Medeco Original KW CLIQ, G = Medeco XT \*\*\*See key section for surcharges for custom coined cut keys or special stamping requirements.  
**Note:** (P) refers to **Pinned** and (S) to **Sub-Assembled** at the end of each part string in the price book.

## Euro Profile Single Cylinder with Thumbturn

Description	Part Number	M <sup>3</sup>	BiLevel	X4	Biax/Orig	KeyMark
 5 Pin, Standard Round "SR" Thumbturn	2313005 X00 (P)	\$147.00			\$152.63	
	2313005 X00 (S)	\$134.00			\$139.63	
 6 Pin, Standard Round "SR" Thumbturn	2313006 X00 (P)	\$154.50			\$160.13	
	2313006 X00 (S)	\$141.50			\$147.13	
 5 Pin, Low Profile "LP" Thumbturn	2313035 X00 (P)	\$147.00			\$152.63	
	2313035 X00 (S)	\$134.00			\$139.63	
 6 Pin, Low Profile "LP" Thumbturn	2313036 X00 (P)	\$154.50			\$160.13	
	2313036 X00 (S)	\$141.50			\$147.13	
 5 Pin, Removable Decorative "RD" Thumbturn	2313045 X00 (P)	\$147.00			\$152.63	
	2313045 X00 (S)	\$134.00			\$139.63	
 6 Pin, Removable Decorative "RD" Thumbturn	2313046 X00 (P)	\$154.50			\$160.13	
	2313046 X00 (S)	\$141.50			\$147.13	
 5 Pin, Removable Lever "RL" Thumbturn	2313055 X00 (P)	\$147.00			\$152.63	
	2313055 X00 (S)	\$134.00			\$139.63	
 6 Pin, Removable Lever "RL" Thumbturn	2313056 X00 (P)	\$154.50			\$160.13	
	2313056 X00 (S)	\$141.50			\$147.13	
 5 Pin, Euro Crescent "CR" Thumbturn	2313065 X00 (P)	\$147.00			\$152.63	
	2313065 X00 (S)	\$134.00			\$139.63	
 6 Pin, Euro Crescent "CR" Thumbturn	2313066 X00 (P)	\$154.50			\$160.13	
	2313066 X00 (S)	\$141.50			\$147.13	

\*\*Refer to the eCylinder section for more detail on specific technologies available and pricing. Technologies are represented by the following letters:  
T = Medeco<sup>3</sup>, S = M<sup>3</sup> CLIQ, J = Medeco<sup>3</sup> BiLevel, W = Biaxial, V = Medeco Biaxial CLIQ, K = Medeco KM, N = Medeco X4, C = Classic CLIQ, M = Medeco X4 CLIQ,  
"." = Original, Z = Medeco Original KW CLIQ, G = Medeco XT \*\*\*See key section for surcharges for custom coined cut keys or special stamping requirements.  
**Note:** (P) refers to **Pinned** and (S) to **Sub-Assembled** at the end of each part string in the price book.

## Euro Profile Double Cylinder

Description	Part Number	M <sup>3</sup>	BiLevel	X4	Biax/Orig	KeyMark
 5 Pin, No Extension	2313025 X00 (P)	\$151.00				\$156.63
	2313025 X00 (S)	\$125.00				\$130.63
 5 Pin Extended, 5 mm Ext. Side (0mm/5mm)	2313025 X01 (P)	\$155.00				\$160.63
	2313025 X01 (S)	\$129.00				\$134.63
 5 Pin Extended, 10 mm Ext. Side (0mm/10mm)	2313025 X02 (P)	\$159.00				\$164.63
	2313025 X02 (S)	\$133.00				\$138.63
 5 Pin Extended, (5mm/5mm)	2313025 X11 (P)	\$159.00				\$164.63
	2313025 X11 (S)	\$133.00				\$138.63
 5 Pin Extended, (5mm/10mm)	2313025 X12 (P)	\$163.00				\$168.63
	2313025 X12 (S)	\$137.00				\$142.63
 6 Pin, No Extension	2313026 X00 (P)	\$161.00				\$166.63
	2313026 X00 (S)	\$135.00				\$140.63
 6 Pin Extended, 5mm Ext. Side (0 mm/5 mm)	2313026 X01 (P)	\$165.00				\$170.63
	2313026 X01 (S)	\$139.00				\$144.63
 6 Pin Extended, 10mm Ext. Side (0 mm/10 mm)	2313026 X02 (P)	\$169.00				\$174.63
	2313026 X02 (S)	\$143.00				\$148.63
 6 Pin Extended, (5mm/10mm)	2313026 X12 (P)	\$173.00				\$178.63
	2313026 X12 (S)	\$147.00				\$152.63

## Euro Profile Half Cylinder

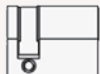
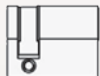
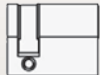
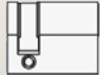
Description	Part Number	M <sup>3</sup>	BiLevel	X4	Biax/Orig	KeyMark
 5 Pin with 12 Position Indexable Cam	2313015 800 (P)	\$126.70				\$132.33
	2313015 800 (S)	\$113.70				\$119.33
 5 Pin, Extended 5 mm with 12 Position Indexable Cam	2313015 801 (P)	\$130.70				\$136.33
	2313015 801 (S)	\$117.70				\$123.33
 6 Pin with 12 Position Indexable Cam	2313016 800 (P)	\$128.30				\$133.93
	2313016 800 (S)	\$115.30				\$120.93
 6 Pin, Extended 5 mm with 12 Position Indexable Cam	2313016 801 (P)	\$132.30				\$137.93
	2313016 801 (S)	\$119.30				\$124.93

\*\*Refer to the eCylinder section for more detail on specific technologies available and pricing. Technologies are represented by the following letters:  
T = Medeco<sup>3</sup>, S = M<sup>3</sup> CLIQ, J = Medeco<sup>3</sup> BiLevel, W = Biaxial, V = Medeco Biaxial CLIQ, K = Medeco KM, N = Medeco X4, C = Classic CLIQ, M = Medeco X4 CLIQ,  
“-” = Original, Z = Medeco Original KW CLIQ, G = Medeco XT \*\*\*See key section for surcharges for custom coined cut keys or special stamping requirements.

**Note:** (P) refers to **Pinned** and (S) to **Sub-Assembled** at the end of each part string in the price book.



## Other International Cylinders

Description	Part Number	M <sup>3</sup>	BiLevel	X4	Biax/Orig	KeyMark
Danish Round Mortise Cylinder	2301016 (P)	\$118.00			\$122.41	
	2301016 (S)	\$105.00			\$109.41	
Danish Special Cam Lock (Ruko®)	23010168 (P)				\$92.61	
	23010168 (S)				\$79.61	
Australian Oval - Less Cams and Pins	2303016A (S)	\$134.00			\$139.63	
5 Pin British Oval Single Cylinder with Thumbturn	2304005 (P)	\$164.00			\$170.34	
	2304005 (S)	\$151.00			\$157.34	
6 Pin British Oval Single Cylinder with Thumbturn	2304006 (P)	\$164.00			\$170.34	
	2304006 (S)	\$151.00			\$157.34	
5 Pin British Oval Half Cylinder	2304015 (P)	\$124.00			\$130.34	
	2304015 (S)	\$111.00			\$117.34	
6 Pin British Oval Half Cylinder	2304016 (P)	\$124.00			\$130.34	
	2304016 (S)	\$111.00			\$117.34	
5 Pin British Oval Double Cylinder	2304025 (P)	\$169.00			\$175.34	
	2304025 (S)	\$143.00			\$149.34	
6 Pin British Oval Double Cylinder	2304026 (P)	\$169.00			\$175.34	
	2304026 (S)	\$143.00			\$149.34	
Scandinavian Oval Exterior Cylinder	2305016 (P)	\$123.00			\$127.62	
	2305016 (S)	\$110.00			\$114.62	
Scandinavian Oval Interior Cylinder	2306016 (P)	\$123.00			\$127.62	
	2306016 (S)	\$110.00			\$114.62	
Norwegian Oval Shape Cylinder	23070165 (P)	\$137.00			\$142.21	
	23070165 (S)	\$124.00			\$129.21	
Scandinavian Snowman Cylinder	23080166 (P)	\$140.00			\$145.33	
	23080166 (S)	\$127.00			\$132.33	
Scandinavian Round Exterior Cylinder	2309016 (P)	\$181.00			\$188.06	
	2309016 (S)	\$168.00			\$175.06	
Scandinavian Round Interior Cylinder	2310016 (P)	\$181.00			\$188.06	
	2310016 (S)	\$168.00			\$175.06	
Italian Cylinder Inner Gate Lock, 3 Pin	2314003 (P)	\$87.10			\$90.21	
	2314003 (S)	\$74.10			\$77.21	
Italian Cylinder Exterior Gate Lock, 5 Pin	2315005 (P)	\$98.30			\$101.88	
	2315005 (S)	\$85.30			\$88.88	
Italian Roller Shutter 4 Pin	2316004 (P)	\$98.30			\$101.88	
	2316004 (S)	\$85.30			\$88.88	
Danish Special Oval Cylinder Assembly	2317016 (P)	\$133.90			\$138.98	
	2317016 (S)	\$120.90			\$125.98	
Danish Cam Lock (for Ruko®) w/ 90° Stop	2320016 (P)	\$118.00			\$122.41	
	2320016 (S)	\$105.00			\$109.41	

\*\*Refer to the eCylinder section for more detail on specific technologies available and pricing. Technologies are represented by the following letters:  
T = Medeco<sup>3</sup>, S = M<sup>3</sup> CLIQ, J = Medeco<sup>3</sup> BiLevel, W = Biaxial, V = Medeco Biaxial CLIQ, K = Medeco KM, N = Medeco X4, C = Classic CLIQ, M = Medeco X4 CLIQ,  
“-” = Original, Z = Medeco Original KW CLIQ, G = Medeco XT \*\*\*See key section for surcharges for custom coined cut keys or special stamping requirements.  
**Note:** (P) refers to **Pinned** and (S) to **Sub-Assembled** at the end of each part string in the price book.

## Profile Components

Description	Part Number	Price
5 Pin Plug For Half Cylinder	12286	\$53.40
5 Pin Double Cylinder Profile Plug	12286	\$53.40
6 Pin Plug For Half Cylinder	12288	\$53.40
6 Pin Double Cylinder Profile Plug	12288	\$53.40
5 Pin Double Cylinder Profile Shell	13327	\$75.20
6 Pin Double Cylinder Profile Shell	13346	\$75.20
5 Pin Shell For Half Cylinder	13365	\$75.20
6 Pin Shell For Half Cylinder	13375	\$75.20
Thumbturn Set Screw	CP-011013-020	\$0.26
Profile Cylinder Set Screw, #8-32 x 1/4"	CP-011013-040	\$0.37
Set Screw for "CR" Thumbturn	CP-012409-030	\$0.55
Thumbturn Set Screw	CP-012411-030	\$0.71
Set Screw For Removable Thumbturn	CP-012411-040	\$0.71
Thumbturn Retaining Clip	CP-020031	\$5.30
Cartridge Retainer	CP-020240	\$0.22
Plug Retaining Clip - Old Style, C Clip	CP-021400	\$1.10
Plug Retaining Clip - Continuous Ring	CP-021490	\$1.50
Tumbler Spring	CP-030001	\$0.09
Single Cylinder Profile Pilot Spring	CP-030024	\$0.59
Single Cylinder Profile Thumbturn Actuator Spring	CP-030025	\$0.21
Actuator Spring For Half Cylinder	CP-030860	\$1.00
Snap Ring	CP-031030	\$0.62
Single Cylinder Profile Actuator	CP-100111	\$10.00
Double Cylinder Profile EAC/EAC Push Rod	CP-100761	Consult Factory
Double Cylinder Profile Clutch	CP-220071	\$7.40
5 and 6 Pin Actuator For Half Cylinder	CP-220090	\$4.50
Clutch Assembly, Emergency	CP-220120	\$26.90
Double Cylinder Profile EAC/EAC Clutch	CP-220201	\$69.90
Double Cylinder Profile Gear Cam	CP-230081	\$8.80
Thumbturn Cylinder Profile Gear Cam	CP-230091	\$8.80
Single Cylinder Profile Thumbturn Actuator Pilot	CP-280261	\$13.50
Standard Round "SR" Thumbturn Assembly 5 Pin	CP-285981-500	\$77.90
Low Profile "LP" Thumbturn Assembly 5 Pin	CP-286011-500	\$52.10
Lever "RL" Thumbturn Assembly 5 Pin	CP-285951-500	\$77.90
Crescent "CR" Thumbturn Assembly 5 Pin	CP-286041-500	\$24.10
Decorative "RD" Thumbturn Assembly 5 Pin	CP-285921-500	\$52.10
Decorative "RD" Thumbturn Only	CP-285901	\$17.30
Lever "RL" Thumbturn Only	CP-285931	\$25.80
Low Profile "SR" Thumbturn Only	CP-285961	\$25.80
Low Profile "LP" Thumbturn Only	CP-285991	\$17.30
Oval Int./Ext. Cylinder tailpiece	CT-Y76	\$4.00
Cam, British Oval (Half/Double)	CT-Z26	\$4.00
Cam, British Oval (Thumbturn)	CT-Z29	\$4.00
Double Cylinder Profile Cam	CT-Z50	\$4.00
Thumbturn Cylinder Profile Cam, Non Indexing	CT-Z51	\$4.00
Indexing Cam For Half Cylinders	CT-Z88	\$4.00
Cam, Medeco XT Double Profile Cyl	CT-Z98	\$4.00
Double Cylinder Profile EAC/EAC Cam	CT-ZA2	\$4.00

\*\*Refer to the eCylinder section for more detail on specific technologies available and pricing. Technologies are represented by the following letters:

T = Medeco<sup>3</sup>, S = M<sup>3</sup> CLIQ, J = Medeco<sup>3</sup> BiLevel, W = Biaxial, V = Medeco Biaxial CLIQ, K = Medeco KM, N = Medeco X4, C = Classic CLIQ, M = Medeco X4 CLIQ, ". " = Original, Z = Medeco Original KW CLIQ, G = Medeco XT \*\*\*See key section for surcharges for custom coined cut keys or special stamping requirements.

**Note:** (P) refers to **Pinned** and (S) to **Sub-Assembled** at the end of each part string in the price book.

# Maxum Deadbolts

FEATURES	Medeco <sup>3</sup>	BiLevel	Medeco X4	CLIQ
UL Listed for use on fire doors having a rating up to three hours	●	●	●	●
ANSI/BHMA 156.36 Grade 1 Certification for auxiliary locks and associated products	●			
ANSI/BHMA A156.30 Level A Certification on the cylinder assures patent protected key control and physical strength	●			
Can be incorporated into existing master key systems	●	●	●	
Security features to protect against drill, wrench, ice pick, kick-in, hammer, bumping and prying attacks	●	●		
Solid brass construction provides high quality and long cylinder life	●	●	●	
Deadbolt is designed to accommodate both mortise and drive-in face applications for greater flexibility and ease of installation	●	●	●	
Large thumbturn provides ease of use for physically challenged individuals	●	●	●	
Keys may be integrated with Hybrid proximity head for greater system retrofit	●	●	●	
Double cylinder captive thumbturn safety option available	●	●		

### Medeco<sup>3</sup> Premium High Security

For effective mechanical protection against most forms of attack as well as protection against unauthorized duplicate keys, Medeco<sup>3</sup> cylinders are recommended. Security features including hardened steel components, pins that must be elevated, rotated, and interact with both a sidebar and a slider, and additional pick resistant features make Medeco<sup>3</sup> the cylinder of choice to protect people, property and information.

### Medeco<sup>3</sup> BiLevel Patented Key Control

Medeco<sup>3</sup> BiLevel cylinders may be incorporated into a master key system with Medeco<sup>3</sup> high security, offering protection against all types of attack where needed, and patented key control cylinders for areas requiring less protection. BiLevel cylinders offer patented control against unauthorized duplication of keys without the additional security features protecting against force or surreptitious attack.

### Medeco X4 Patented Key Control

Medeco X4 cylinders offer patented control against unauthorized duplication of keys without the additional security features protecting against force or surreptitious attack.

### Intelligent Key Solutions

Many of the cylinders in this section are also available with an Intelligent Key solution. See the Intelligent Key section for more details.

# Medeco Maxum® Deadbolts

Deadbolts are about strength. Just hold a Medeco® ANSI Grade 1 Maxum® deadbolt in your hand, and you know this is one tough hunk of protection. As tough as a Maxum deadbolt is on the outside, it's that smart on the inside. It can be ordered with the triple-locking security of a Medeco<sup>3</sup> cylinder. Recommended for residential and business use, it's available as a single- or double-cylinder or with a unique "captive thumbturn." The captive thumbturn converts the inside cylinder to a thumbturn for safe exit when the facility is occupied. A quick conversion when the facility is not occupied returns it to double cylinder mode and guards against unauthorized entry or exit. Maxum® deadbolts offer maximum protection with solid-brass construction, along with anti-drilling and anti-prying features.



### Patented Key Control

Protects against unauthorized duplication of your keys.



### Certified Grade 1

BHMA certified Grade 1, passes to the highest standards in the industry.



### Drill Protection

Offers maximum protection with solid-brass construction and strategically placed drill pins.



### Protection From Physical Attack

Medeco<sup>3</sup> Medeco Maxum Deadbolts are UL 437 Listed and stand up to prying, picking and other forms of physical attack.



### Special Angle Cut Keys

Requires a special key cutting machine and access to Medeco specific blanks, available in a variety of restrictions to support every need.



### Picking and Bumping Protection

Medeco<sup>3</sup> cylinders use a sidebar that prevent the key from rotating until it is elevated, rotated and aligned in the correct position. This feature protects against bumping and picking attacks.

## Technical Information:

- SFIC cylinder options include Medeco X4 and Medeco XT
- Unique "captive thumbturn" option available
- Bolt is designed for easy conversion accommodating either mortise or drive-in applications
- Solid-brass construction with steel inserts for added protection

- ANSI/BHMA A156.36 Grade 1 and UL437 Listed cylinders for high security
- Fits doors 1 3/8" to 2 1/2" thick
- Standard 2 1/8" crossbore and 1" edge bore (ANSI A115.13 prep)

## Warranty:

Warranted for two (2) years against manufacturer's defects. See the Medeco® Limited Warranty for full details.

## Finishes:

Available in all standard finishes to match existing hardware.

## Applications:

It is the ideal choice for a wide variety of commercial and heavy duty residential applications where consistent quality, ease of use and installation are required. Ideal applications include:

- Office buildings
- Hospitals
- Schools
- Restaurants
- Apartments
- Retail outlets

## Available Key Technologies:

### Mechanical:

- Medeco<sup>3</sup>
- Medeco<sup>3</sup> BiLevel
- Medeco X4

### eCylinder:

- M<sup>3</sup> CLIQ
- Classic CLIQ
- Medeco X4 CLIQ

## How to Order:

<p><b>1</b></p> <p><b>11C601</b> base part #</p> <p>Refer to pages 144-150 for descriptions and technical specifications to find the corresponding base part number.</p>	<p><b>2</b></p> <p><b>T</b> cylinder</p> <ul style="list-style-type: none"> <li>- = Original</li> <li>K = Medeco KM</li> <li>T = Medeco<sup>3</sup></li> <li>W = Biaxial</li> <li>J = Medeco<sup>3</sup> BiLevel</li> <li>C = Classic CLIQ</li> <li>N = Medeco X4</li> </ul>	<p><b>3</b></p> <p><b>05</b> finish</p> <p>Refer to the inside back cover of this catalog for finish options. Include the corresponding two digit finish number.</p> <p>Upcharge for split finish.</p>	<p><b>4</b></p> <p><b>LT</b> keyway</p> <p>Insert keyway if known or contact Customer Service for help.</p>	<p><b>5</b></p> <table border="1"> <tr> <td> <p><b>S =</b> <b>Sub-Assembled (Uncombined)</b> No additional information needed</p> </td> <td> <p><b>P =</b> <b>Pinned (Combined)</b> Keyed alike (KA) Keyed different (KD) 2 keys per cylinder</p> </td> <td> <p><b>M =</b> <b>Master Keyed</b> Provide specific pinning or contact Customer Service for support Must specify quantity for keys.</p> </td> </tr> </table>	<p><b>S =</b> <b>Sub-Assembled (Uncombined)</b> No additional information needed</p>	<p><b>P =</b> <b>Pinned (Combined)</b> Keyed alike (KA) Keyed different (KD) 2 keys per cylinder</p>	<p><b>M =</b> <b>Master Keyed</b> Provide specific pinning or contact Customer Service for support Must specify quantity for keys.</p>
<p><b>S =</b> <b>Sub-Assembled (Uncombined)</b> No additional information needed</p>	<p><b>P =</b> <b>Pinned (Combined)</b> Keyed alike (KA) Keyed different (KD) 2 keys per cylinder</p>	<p><b>M =</b> <b>Master Keyed</b> Provide specific pinning or contact Customer Service for support Must specify quantity for keys.</p>					

### BUILD A MAXUM DEADBOLT BASE PART#

11XXXX

<p><b>Maxum Deadbolt</b> _____</p> <p><b>Trim</b> _____</p> <ul style="list-style-type: none"> <li>C = Commercial</li> <li>R = Residential</li> </ul> <p><b>Cylinder Type</b> _____</p> <ul style="list-style-type: none"> <li>2 = Blank Plate</li> <li>3 = LFIC (6 Pin)</li> <li>4 = LFIC (Less Core)</li> <li>5 = Medeco (5 Pin)</li> <li>6 = Medeco (6 Pin)</li> <li>7 = SFIC (Less Core)</li> <li>8 = SFIC (6 Pin)</li> <li>9 = SFIC (7 Pin)</li> </ul> <p><b>Function</b> _____</p> <ul style="list-style-type: none"> <li>0 = Cylinder x Thumbturn</li> <li>1 = Cylinder x Thumbturn (Classroom)</li> <li>2 = Cylinder x Cylinder</li> <li>3 = Cylinder x Cylinder (Captive)</li> <li>4 = Cylinder x Plate (mounting screws on plate side)</li> <li>5 = Dummy x Thumbturn</li> <li>6 = Dummy x Cylinder</li> <li>7 = Dummy x Plate (mounting screws on plate side)</li> <li>8 = Plate x Thumbturn (mounting screws on thumbturn side)</li> <li>9 = Plate x Cylinder (mounting screws on cylinder side)</li> <li>D = Dummy x Dummy</li> <li>P = Plate x Plate</li> </ul>	<p><b>Backset</b></p> <ul style="list-style-type: none"> <li>1 = 2 3/8" Backset, 1 1/8" Front</li> <li>2 = 2 3/4" Backset, 1 1/8" Front</li> <li>3 = 2 3/8" Backset, 1" Front</li> <li>4 = 2 3/4" Backset, 1" Front</li> <li>5 = 2 3/8" Backset, Round Front</li> <li>6 = 2 3/4" Backset, Round Front</li> <li>L = Less Bolt Assembly</li> </ul>
---	--

\*\*Refer to the eCylinder section for more detail on specific technologies available and pricing. Technologies are represented by the following letters: T = Medeco<sup>3</sup>, S = M<sup>3</sup> CLIQ, J = Medeco<sup>3</sup> BiLevel, W = Biaxial, V = Medeco Biaxial CLIQ, K = Medeco KM, N = Medeco X4, C = Classic CLIQ, M = Medeco X4 CLIQ, "-" = Original, Z = Medeco Original KW CLIQ, G = Medeco XT \*\*\*See key section for surcharges for custom coined cut keys or special stamping requirements.  
**Note:** (P) refers to **Pinned** and (S) to **Sub-Assembled** at the end of each part string in the price book.

## Single Cylinder Maxum Deadbolt – Commercial Trim

Description	Part Number	M <sup>3</sup>	BiLevel	X4	Biax/Orig	KeyMark
Maxum Deadbolt Lock, Blank Plate Outside with Inside Thumbturn, 1 1/8" Faceplate†, 2 3/8" Backset	11C281	\$191.00				
Maxum Deadbolt Lock, Blank Plate Outside with Inside Thumbturn, 1 1/8" Faceplate†, 2 3/4" Backset	11C282	\$191.00				
Single Cylinder Maxum Deadbolt Lock, 1 1/8" Faceplate, 2 3/8" Backset	11C601 (P)	\$228.00	\$189.65		\$237.03	
	11C601 (S)	\$215.00	\$182.75		\$224.03	
Single Cylinder Maxum Deadbolt Lock, 1 1/8" Faceplate, 2 3/4" Backset	11C602 (P)	\$228.00	\$189.65		\$237.03	
	11C602 (S)	\$215.00	\$182.75		\$224.03	
Single Cylinder Maxum Deadbolt Lock, 1" Faceplate, 2 3/8" Backset	11C603 (P)	\$228.00	\$189.65		\$237.03	
	11C603 (S)	\$215.00	\$182.75		\$224.03	
Single Cylinder Maxum Deadbolt Lock, 1" Faceplate, 2 3/4" Backset	11C604 (P)	\$228.00	\$189.65		\$237.03	
	11C604 (S)	\$215.00	\$182.75		\$224.03	
Single Cylinder Maxum Deadbolt Lock, Drive In Front, 2 3/8" Backset	11C605 (P)	\$228.00	\$189.65		\$237.03	
	11C605 (S)	\$215.00	\$182.75		\$224.03	
Single Cylinder Maxum Deadbolt Lock, Drive In Front, 2 3/4" Backset	11C606 (P)	\$228.00	\$189.65		\$237.03	
	11C606 (S)	\$215.00	\$182.75		\$224.03	
Single Cylinder Maxum Deadbolt Lock, Less Bolt	11C60L (P)	\$159.90	\$121.55		\$168.93	
	11C60L (S)	\$146.90	\$114.65		\$155.93	
Single Cylinder Maxum Deadbolt Lock, Classroom Function, 1 1/8" Faceplate, 2 3/8" Backset	11C611 (P)	\$234.00			\$243.28	
	11C611 (S)	\$221.00			\$230.28	
Single Cylinder Maxum Deadbolt Lock, Classroom Function, Drive In, 2 3/8" Backset	11C615 (P)	\$234.00			\$243.28	
	11C615 (S)	\$221.00			\$230.28	
Single Cylinder Maxum Deadbolt Lock, Classroom Function, Drive In, 2 3/4" Backset	11C616 (P)	\$234.00			\$243.28	
	11C616 (S)	\$221.00			\$230.28	
Single Cylinder Maxum Deadbolt Lock, Classroom Function, Less Bolt	11C61L (P)	\$165.90			\$175.18	
	11C61L (S)	\$152.90			\$162.18	
Single Cylinder Maxum Deadbolt Lock, Classroom Function, 1 1/8" Faceplate, 2 3/4" Backset	11C612 (P)	\$234.00			\$243.28	
	11C612 (S)	\$221.00			\$230.28	
Single Cylinder Maxum Deadbolt Lock, Classroom Function, 1" Faceplate, 2 3/8" Backset	11C613 (P)	\$234.00			\$243.28	
	11C613 (S)	\$221.00			\$230.28	
Single Cylinder Maxum Deadbolt Lock, Classroom Function, 1" Faceplate, 2 3/4" Backset	11C614 (P)	\$234.00			\$243.28	
	11C614 (S)	\$221.00			\$230.28	
Single Cylinder Maxum Deadbolt Lock with Blank Plate Inside, 1 1/8" Faceplate, 2 3/8" Backset	11C641 (P)	\$224.00			\$232.86	
	11C641 (S)	\$211.00			\$219.86	
Single Cylinder Maxum Deadbolt Lock with Blank Plate Inside, 1 1/8" Faceplate, 2 3/4" Backset	11C642 (P)	\$224.00			\$232.86	
	11C642 (S)	\$211.00			\$219.86	
Single Cylinder Maxum Deadbolt Lock, with Blank Plate Outside, 1 1/8" Faceplate*, 2 3/8" Backset	11C691 (P)	\$224.00			\$232.86	
	11C691 (S)	\$211.00			\$219.86	
Single Cylinder Maxum Deadbolt Lock, with Blank Plate Outside, 1 1/8" Faceplate, 2 3/4" Backset	11C692 (P)	\$224.00			\$232.86	
	11C692 (S)	\$211.00			\$219.86	

\*\*Refer to the eCylinder section for more detail on specific technologies available and pricing. Technologies are represented by the following letters:  
T = Medeco<sup>3</sup>, S = M<sup>3</sup> CLIQ, J = Medeco<sup>3</sup> BiLevel, W = Biaxial, V = Medeco Biaxial CLIQ, K = Medeco KM, N = Medeco X4, C = Classic CLIQ, M = Medeco X4 CLIQ,  
"-" = Original, Z = Medeco Original KW CLIQ, G = Medeco XT \*\*\*See key section for surcharges for custom coined cut keys or special stamping requirements.

**Note:** (P) refers to **Pinned** and (S) to **Sub-Assembled** at the end of each part string in the price book.



## LFIC Single Cylinder Maxum – Commercial Trim

Description	Part Number	M <sup>3</sup>	BiLevel	X4	Biax/Orig	KeyMark
LFIC Single Cylinder Maxum Deadbolt Lock, Less Bolt	11C30L (P)	\$240.90			\$253.33	
	11C30L (S)	\$227.90			\$240.33	
LFIC Single Cylinder Maxum Deadbolt Lock, 1 1/8" Faceplate, 2 3/8" Backset	11C301 (P)	\$309.00			\$321.43	
	11C301 (S)	\$296.00			\$308.43	
LFIC Single Cylinder Maxum Deadbolt Lock, 1 1/8" Faceplate, 2 3/4" Backset	11C302 (P)	\$309.00			\$321.43	
	11C302 (S)	\$296.00			\$308.43	
LFIC Single Cylinder Maxum Deadbolt Lock, 1" Faceplate, 2 3/8" Backset	11C303 (P)	\$309.00			\$321.43	
	11C303 (S)	\$296.00			\$308.43	
LFIC Single Cylinder Maxum Deadbolt Lock, 1" Faceplate, 2 3/4" Backset	11C304 (P)	\$309.00			\$321.43	
	11C304 (S)	\$296.00			\$308.43	
LFIC Single Cylinder Maxum Deadbolt Lock, Drive-In Front, 2 3/8" Backset	11C305 (P)	\$309.00			\$321.43	
	11C305 (S)	\$296.00			\$308.43	
LFIC Single Cylinder Maxum Deadbolt Lock, Drive-In Front, 2 3/4" Backset	11C306 (P)	\$309.00			\$321.43	
	11C306 (S)	\$296.00			\$308.43	
LFIC Single Cylinder Maxum Deadbolt Lock Classroom Function, 1 1/8" Faceplate, 2 3/8" Backset	11C311 (P)	\$315.00			\$327.68	
	11C311 (S)	\$302.00			\$314.68	
LFIC Single Cylinder Maxum Deadbolt Lock Classroom Function, 1 1/8" Faceplate, 2 3/4" Backset	11C312 (P)	\$315.00			\$327.68	
	11C312 (S)	\$302.00			\$314.68	
LFIC Single Cylinder Maxum Deadbolt Lock Classroom Function, 1" Faceplate, 2 3/8" Backset	11C313 (P)	\$315.00			\$327.68	
	11C313 (S)	\$302.00			\$314.68	
LFIC Single Cylinder Maxum Deadbolt Lock Classroom Function, 1" Faceplate, 2 3/4" Backset	11C314 (P)	\$315.00			\$327.68	
	11C314 (S)	\$302.00			\$314.68	
LFIC Single Cylinder Maxum Deadbolt Lock Classroom Function, Drive-In Front, 2 3/8" Backset	11C315 (P)	\$315.00			\$327.68	
	11C315 (S)	\$302.00			\$314.68	
LFIC Single Cylinder Maxum Deadbolt Lock Classroom Function, Drive-In Front, 2 3/4" Backset	11C316 (P)	\$315.00			\$327.68	
	11C316 (S)	\$302.00			\$314.68	
LFIC Single Cylinder Maxum Deadbolt Lock Classroom Function, Less Bolt	11C31L (P)	\$246.90			\$259.58	
	11C31L (S)	\$233.90			\$246.58	
LFIC Single Cylinder Maxum Deadbolt Lock, Blank Inside, 1 1/8" Faceplate, 2 3/8" Backset	11C341 (P)	\$305.00			\$317.26	
	11C341 (S)	\$292.00			\$304.26	
LFIC Single Cylinder Maxum Deadbolt Lock, Blank Inside, 1 1/8" Faceplate, 2 3/4" Backset	11C342 (P)	\$305.00			\$317.26	
	11C342 (S)	\$292.00			\$304.26	
LFIC Single Cylinder Maxum Deadbolt Lock, Blank Outside, 1 1/8" Faceplate *, 2 3/8" Backset	11C391 (P)	\$305.00			\$317.26	
	11C391 (S)	\$292.00			\$304.26	
LFIC Single Cylinder Maxum Deadbolt Lock, Blank Outside, 1 1/8" Faceplate *, 2 3/4" Backset	11C392 (P)	\$305.00			\$317.26	
	11C392 (S)	\$292.00			\$304.26	
LFIC Single Cylinder Maxum Deadbolt Lock, 1 1/8" Faceplate, Less Core, 2 3/8" Backset	11C401	\$177.00			\$177.00	
LFIC Single Cylinder Maxum Deadbolt Lock, 1 1/8" Faceplate, Less Core, 2 3/4" Backset	11C402	\$177.00			\$177.00	
LFIC Single Cylinder Maxum Deadbolt Lock, Drive-In Front, Less Core, 2 3/8" Backset	11C405	\$177.00			\$177.00	
LFIC Single Cylinder Maxum Deadbolt Lock, Drive-In Front, Less Core, 2 3/4" Backset	11C406	\$177.00			\$177.00	

\*\*Refer to the eCylinder section for more detail on specific technologies available and pricing. Technologies are represented by the following letters:  
T = Medeco<sup>3</sup>, S = M<sup>3</sup> CLIQ, J = Medeco<sup>3</sup> BiLevel, W = Biaxial, V = Medeco Biaxial CLIQ, K = Medeco KM, N = Medeco X4, C = Classic CLIQ, M = Medeco X4 CLIQ,  
"-" = Original, Z = Medeco Original KW CLIQ, G = Medeco XT \*\*\*See key section for surcharges for custom coined cut keys or special stamping requirements.  
**Note:** (P) refers to **Pinned** and (S) to **Sub-Assembled** at the end of each part string in the price book.



## SFIC Single Cylinder Maxum – Commercial Trim

Description	Part Number	M <sup>3</sup>	BiLevel	X4	Biax/Orig	KeyMark
SFIC Single Cylinder Maxum Deadbolt Lock, 1 1/8" Faceplate, Less Core, 2 3/8" Backset	11C701				\$177.00	\$177.00
SFIC Single Cylinder Maxum Deadbolt Lock, 1 1/8" Faceplate, Less Core, 2 3/4" Backset	11C702				\$177.00	\$177.00
SFIC Single Cylinder Maxum Deadbolt Lock, 1" Faceplate, Less Core, 2 3/8" Backset	11C703				\$177.00	\$177.00
SFIC Single Cylinder Maxum Deadbolt Lock, 1" Faceplate, Less Core, 2 3/4" Backset	11C704				\$177.00	\$177.00
SFIC Single Cylinder Maxum Deadbolt Lock, Drive-In Front, Less Core, 2 3/8" Backset	11C705				\$177.00	\$177.00
SFIC Single Cylinder Maxum Deadbolt Lock, Drive-In Front, Less Core, 2 3/4" Backset	11C706				\$177.00	\$177.00
SFIC Single Cylinder Maxum Deadbolt Lock, Classroom Function, 1 1/8" Faceplate, Less Core, 2 3/8" Backset	11C711				\$174.00	\$174.00
SFIC Single Cylinder Maxum Deadbolt Lock, Classroom Function, 1 1/8" Faceplate, Less Core, 2 3/4" Backset	11C712				\$174.00	\$174.00
SFIC Single Cylinder Maxum Deadbolt Lock, Classroom Function, 1" Faceplate, Less Core, 2 3/8" Backset	11C713				\$174.00	\$174.00
SFIC Single Cylinder Maxum Deadbolt Lock, Classroom Function, 1" Faceplate, Less Core, 2 3/4" Backset	11C714				\$174.00	\$174.00
SFIC Single Cylinder Maxum Deadbolt Lock, Classroom Function, Drive-In Front, Less Core, 2 3/8" Backset	11C715				\$174.00	\$174.00
SFIC Single Cylinder Maxum Deadbolt Lock, Classroom Function, Drive-In Front, Less Core, 2 3/4" Backset	11C716				\$174.00	\$174.00
SFIC Single Cylinder Maxum Deadbolt Lock, 1 1/8" Faceplate, 6 Pin SFIC Cylinder, 2 3/8" Backset	11C801 (P)				\$239.00	\$248.49
	11C801 (S)				\$226.00	\$235.49
SFIC Single Cylinder Maxum Deadbolt Lock, 1 1/8" Faceplate, 6 Pin SFIC Cylinder, 2 3/4" Backset	11C802 (P)				\$239.00	\$248.49
	11C802 (S)				\$226.00	\$235.49
SFIC Single Cylinder Maxum Deadbolt Lock, 1" Faceplate, 6 Pin SFIC Cylinder, 2 3/8" Backset	11C803 (P)				\$239.00	\$248.39
	11C803 (S)				\$226.00	\$235.49
SFIC Single Cylinder Maxum Deadbolt Lock, 1" Faceplate, 6 Pin SFIC Cylinder, 2 3/4" Backset	11C804 (P)				\$239.00	\$248.39
	11C804 (S)				\$226.00	\$235.49
SFIC Single Cylinder Maxum Deadbolt Lock, Drive-In Front, 6 Pin SFIC Cylinder, 2 3/8" Backset	11C805 (P)				\$239.00	\$248.49
	11C805 (S)				\$226.00	\$235.49
SFIC Single Cylinder Maxum Deadbolt Lock, Drive-In Front, 6 Pin SFIC Cylinder, 2 3/4" Backset	11C806 (P)				\$239.00	\$248.49
	11C806 (S)				\$226.00	\$235.49
SFIC Single Cylinder Maxum Deadbolt Lock, Classroom Funct., 1 1/8" Faceplate, 6 Pin SFIC Cyl. 2 3/8" Backset	11C811 (P)				\$245.00	\$254.74
	11C811 (S)				\$232.00	\$241.74
SFIC Single Cylinder Maxum Deadbolt Lock, Classroom Funct., 1 1/8" Faceplate, 6 Pin SFIC Cyl. 2 3/4" Backset	11C812 (P)				\$245.00	\$254.74
	11C812 (S)				\$232.00	\$241.74
SFIC Single Cylinder Maxum Deadbolt Lock, Classroom Funct., 1" Faceplate, 6 Pin SFIC Cyl. 2 3/8" Backset	11C813 (P)				\$245.00	\$254.74
	11C813 (S)				\$232.00	\$241.74
SFIC Single Cylinder Maxum Deadbolt Lock, Classroom Funct., 1" Faceplate, 6 Pin SFIC Cyl. 2 3/4" Backset	11C814 (P)				\$245.00	\$254.74
	11C814 (S)				\$232.00	\$241.74

\*\*Refer to the eCylinder section for more detail on specific technologies available and pricing. Technologies are represented by the following letters:

T = Medeco<sup>3</sup>, S = M<sup>3</sup> CLIQ, J = Medeco<sup>3</sup> BiLevel, W = Biaxial, V = Medeco Biaxial CLIQ, K = Medeco KM, N = Medeco X4, C = Classic CLIQ, M = Medeco X4 CLIQ, ". " = Original, Z = Medeco Original KW CLIQ, G = Medeco XT \*\*\*See key section for surcharges for custom coined cut keys or special stamping requirements.

**Note:** (P) refers to **Pinned** and (S) to **Sub-Assembled** at the end of each part string in the price book.

## SFIC Single Cylinder Maxum – Commercial Trim

Description	Part Number	M <sup>3</sup>	BiLevel	X4	Biax/Orig	KeyMark
SFIC Single Cylinder Maxum Deadbolt Lock, Classroom Function, Drive-In Front, 6 Pin SFIC Cylinder, 2 3/8" Backset	11C815 (P)			\$245.00		\$254.74
	11C815 (S)			\$232.00		\$241.74
SFIC Single Cylinder Maxum Deadbolt Lock, Classroom Function, Drive-In Front, 6 Pin SFIC Cylinder, 2 3/4" Backset	11C816 (P)			\$245.00		\$254.74
	11C816 (S)			\$232.00		\$241.74
SFIC Single Cylinder Maxum Deadbolt Lock, Blank Inside, 1 1/8" Faceplate, 6 Pin SFIC Cylinder, 2 3/8" Backset	11C841 (P)			\$235.00		\$244.32
	11C841 (S)			\$222.00		\$231.32
SFIC Single Cylinder Maxum Deadbolt Lock, Blank Inside, 1 1/8" Faceplate, 6 Pin SFIC Cylinder, 2 3/4" Backset	11C842 (P)			\$235.00		\$244.32
	11C842 (S)			\$222.00		\$231.32
SFIC Single Cylinder Maxum Deadbolt Lock, Blank Outside, 1 1/8" Faceplate, 6 Pin SFIC Cylinder *, 2 3/8" Backset	11C891 (P)			\$235.00		\$244.32
	11C891 (S)			\$222.00		\$231.32
SFIC Single Cylinder Maxum Deadbolt Lock, Blank Outside, 1 1/8" Faceplate, 6 Pin SFIC Cylinder *, 2 3/4" Backset	11C892 (P)			\$235.00		\$244.32
	11C892 (S)			\$222.00		\$231.32
SFIC Single Cylinder Maxum Deadbolt Lock, 1 1/8" Faceplate, 7 Pin SFIC Cylinder, 2 3/8" Backset	11C901 (P)			\$239.00		\$248.49
	11C901 (S)			\$226.00		\$235.49
SFIC Single Cylinder Maxum Deadbolt Lock, 1 1/8" Faceplate, 7 Pin SFIC Cylinder, 2 3/4" Backset	11C902 (P)			\$239.00		\$248.49
	11C902 (S)			\$226.00		\$235.49
SFIC Single Cylinder Maxum Deadbolt Lock, 1" Faceplate, 7 Pin SFIC Cylinder, 2 3/8" Backset	11C903 (P)			\$239.00		\$248.49
	11C903 (S)			\$226.00		\$235.49
SFIC Single Cylinder Maxum Deadbolt Lock, 1" Faceplate, 7 Pin SFIC Cylinder, 2 3/4" Backset	11C904 (P)			\$239.00		\$248.49
	11C904 (S)			\$226.00		\$235.49
SFIC Single Cylinder Maxum Deadbolt Lock, Drive-In Front, 7 Pin SFIC Cylinder, 2 3/8" Backset	11C905 (P)			\$239.00		\$248.49
	11C905 (S)			\$226.00		\$235.49
SFIC Single Cylinder Maxum Deadbolt Lock, Drive-In Front, 7 Pin SFIC Cylinder, 2 3/4" Backset	11C906 (P)			\$239.00		\$248.49
	11C906 (S)			\$226.00		\$235.49
SFIC Single Cylinder Maxum Deadbolt Lock, Classroom Function, 1 1/8" Faceplate, 7 Pin SFIC Cylinder, 2 3/8" Backset	11C911 (P)			\$245.00		\$254.74
	11C911 (S)			\$232.00		\$241.74
SFIC Single Cylinder Maxum Deadbolt Lock, Classroom Function, 1 1/8" Faceplate, 7 Pin SFIC Cylinder, 2 3/4" Backset	11C912 (P)			\$245.00		\$254.74
	11C912 (S)			\$232.00		\$241.74
SFIC Single Cylinder Maxum Deadbolt Lock, Classroom Function, 1" Faceplate, 7 Pin SFIC Cylinder, 2 3/8" Backset	11C913 (P)			\$245.00		\$254.74
	11C913 (S)			\$232.00		\$241.74
SFIC Single Cylinder Maxum Deadbolt Lock, Classroom Function, 1" Faceplate, 7 Pin SFIC Cylinder, 2 3/4" Backset	11C914 (P)			\$245.00		\$254.74
	11C914 (S)			\$232.00		\$241.74
SFIC Single Cylinder Maxum Deadbolt Lock, Classroom Function, Drive-In Front, 7 Pin SFIC Cylinder, 2 3/8" Backset	11C915 (P)			\$245.00		\$254.74
	11C915 (S)			\$232.00		\$241.74
SFIC Single Cylinder Maxum Deadbolt Lock, Classroom Function, Drive-In Front, 7 Pin SFIC Cylinder, 2 3/4" Backset	11C916 (P)			\$245.00		\$254.74
	11C916 (S)			\$232.00		\$241.74
SFIC Single Cylinder Maxum Deadbolt Lock, Blank Inside, 1 1/8" Faceplate, 7 Pin SFIC Cylinder, 2 3/8" Backset	11C941 (P)			\$235.00		\$244.32
	11C941 (S)			\$222.00		\$231.32
SFIC Single Cylinder Maxum Deadbolt Lock, Blank Inside, 1 1/8" Faceplate, 7 Pin SFIC Cylinder, 2 3/4" Backset	11C942 (P)			\$235.00		\$244.32
	11C942 (S)			\$222.00		\$231.32
SFIC Single Cylinder Maxum Deadbolt Lock, Blank Outside, 1 1/8" Faceplate, 7 Pin SFIC Cylinder *, 2 3/8" Backset	11C991 (P)			\$235.00		\$244.32
	11C991 (S)			\$222.00		\$231.32
SFIC Single Cylinder Maxum Deadbolt Lock, Blank Outside, 1 1/8" Faceplate, 7 Pin SFIC Cylinder *, 2 3/4" Backset	11C992 (P)			\$235.00		\$244.32
	11C992 (S)			\$222.00		\$231.32

\*\*Refer to the eCylinder section for more detail on specific technologies available and pricing. Technologies are represented by the following letters:

T = Medeco<sup>3</sup>, S = M<sup>3</sup> CLIQ, J = Medeco<sup>3</sup> BiLevel, W = Biaxial, V = Medeco Biaxial CLIQ, K = Medeco KM, N = Medeco X4, C = Classic CLIQ, M = Medeco X4 CLIQ, ". " = Original, Z = Medeco Original KW CLIQ, G = Medeco XT \*\*\*See key section for surcharges for custom coined cut keys or special stamping requirements.

**Note:** (P) refers to **Pinned** and (S) to **Sub-Assembled** at the end of each part string in the price book.

### Double Cylinder Maxum Deadbolt – Commercial Trim

Description	Part Number	M <sup>3</sup>	BiLevel	X4	Biax/Orig	KeyMark
Double Cylinder Maxum Deadbolt Lock, 1 1/8" Faceplate, 2 3/8" Backset	11C621 (P)	\$316.00	\$260.30		\$328.18	
	11C621 (S)	\$290.00	\$246.50		\$302.18	
Double Cylinder Maxum Deadbolt Lock, 1 1/8" Faceplate, 2 3/4" Backset	11C622 (P)	\$316.00	\$260.30		\$328.18	
	11C622 (S)	\$290.00	\$246.50		\$302.18	
Double Cylinder Maxum Deadbolt Lock, 1" Faceplate, 2 3/8" Backset	11C623 (P)	\$316.00	\$260.30		\$328.18	
	11C623 (S)	\$290.00	\$246.50		\$302.18	
Double Cylinder Maxum Deadbolt Lock, 1" Faceplate, 2 3/4" Backset	11C624 (P)	\$316.00	\$260.30		\$328.18	
	11C624 (S)	\$290.00	\$246.50		\$302.18	
Double Cylinder Maxum Deadbolt Lock, Drive-In Front, 2 3/8" Backset	11C625 (P)	\$316.00	\$260.30		\$328.18	
	11C625 (S)	\$290.00	\$246.50		\$302.18	
Double Cylinder Maxum Deadbolt Lock, Drive-In Front, 2 3/4" Backset	11C626 (P)	\$316.00	\$260.30		\$328.18	
	11C626 (S)	\$290.00	\$246.50		\$302.18	
Double Cylinder Maxum Deadbolt Lock, Less Bolt	11C62L (P)	\$247.90	\$192.20		\$260.08	
	11C62L (S)	\$221.90	\$178.40		\$234.08	

### Double Cylinder Captive Thumbturn Maxum – Commercial Trim

Description	Part Number	M <sup>3</sup>	BiLevel	X4	Biax/Orig	KeyMark
Captive Double Cylinder Maxum Deadbolt Lock, Less Bolt, 1 3/4" - 2" door	11C63L (P)	\$288.90	\$227.05		\$302.80	
	11C63L (S)	\$262.90	\$213.25		\$276.80	
Captive Double Cylinder Maxum Deadbolt Lock, 1 1/8" Faceplate, 1 3/4" - 2" door, 2 3/8" Backset	11C631 (P)	\$357.00	\$295.15		\$370.90	
	11C631 (S)	\$331.00	\$281.35		\$344.90	
Captive Double Cylinder Maxum Deadbolt Lock, 1 1/8" Faceplate, 2 1/4" - 2 1/2" door, 2 3/8" Backset	11C631T (P)	\$357.00	\$295.15		\$370.90	
	11C631T (S)	\$331.00	\$281.35		\$344.90	
Captive Double Cylinder Maxum Deadbolt Lock, 1 1/8" Faceplate, 1 3/4" - 2" door, 2 3/4" Backset	11C632 (P)	\$357.00	\$295.15		\$370.90	
	11C632 (S)	\$331.00	\$281.35		\$344.90	
Captive Double Cylinder Maxum Deadbolt Lock, 1 1/8" Faceplate, 2 1/4" - 2 1/2" door, 2 3/4" Backset	11C632T (P)	\$357.00	\$295.15		\$370.90	
	11C632T (S)	\$331.00	\$281.35		\$344.90	
Captive Double Cylinder Maxum Deadbolt Lock, 1" Faceplate, 1 3/4" - 2" door, 2 3/8" Backset	11C633 (P)	\$357.00	\$295.15		\$370.90	
	11C633 (S)	\$331.00	\$281.35		\$344.90	
Captive Double Cylinder Maxum Deadbolt Lock, 1" Faceplate, 2 1/4" - 2 1/2" door, 2 3/8" Backset	11C633T (P)	\$357.00	\$295.15		\$370.90	
	11C633T (S)	\$331.00	\$281.35		\$344.90	
Captive Double Cylinder Maxum Deadbolt Lock, 1" Faceplate, 1 3/4" - 2" door	11C634 (P)	\$357.00	\$295.15		\$370.90	
	11C634 (S)	\$331.00	\$281.35		\$344.90	
Captive Double Cylinder Maxum Deadbolt Lock, 1" Faceplate, 2 1/4" - 2 1/2" door, 2 3/4" Backset	11C634T (P)	\$357.00	\$295.15		\$370.90	
	11C634T (S)	\$331.00	\$281.35		\$344.90	
Captive Double Cylinder Maxum Deadbolt Lock, Drive-In Front, 1 3/4" - 2" door, 2 3/8" Backset	11C635 (P)	\$357.00	\$295.15		\$370.90	
	11C635 (S)	\$331.00	\$281.35		\$344.90	
Captive Double Cylinder Maxum Deadbolt Lock, Drive-In Front, 2 1/4" - 2 1/2" door, 2 3/8" Backset	11C635T (P)	\$357.00	\$295.15		\$370.90	
	11C635T (S)	\$331.00	\$281.35		\$344.90	
Captive Double Cylinder Maxum Deadbolt Lock, Drive-In Front, 1 3/4" - 2" door, 2 3/4" Backset	11C636 (P)	\$357.00	\$295.15		\$370.90	
	11C636 (S)	\$331.00	\$281.35		\$344.90	
Captive Double Cylinder Maxum Deadbolt Lock, Drive-In Front, 2 1/4" - 2 1/2" door, 2 3/4" Backset	11C636T (P)	\$357.00	\$295.15		\$370.90	
	11C636T (S)	\$331.00	\$281.35		\$344.90	
Captive Double Cylinder Maxum Deadbolt Lock, Less Bolt, 2 1/4" - 2 1/2" door	11C63LT (P)	\$288.90	\$227.05		\$302.80	
	11C63LT (S)	\$262.90	\$213.25		\$276.80	

\*\*Refer to the eCylinder section for more detail on specific technologies available and pricing. Technologies are represented by the following letters:

T = Medeco<sup>3</sup>, S = M<sup>3</sup> CLIQ, J = Medeco<sup>3</sup> BiLevel, W = Biaxial, V = Medeco Biaxial CLIQ, K = Medeco KM, N = Medeco X4, C = Classic CLIQ, M = Medeco X4 CLIQ, ". = Original, Z = Medeco Original KW CLIQ, G = Medeco XT \*\*\*See key section for surcharges for custom coined cut keys or special stamping requirements.

**Note:** (P) refers to **Pinned** and (S) to **Sub-Assembled** at the end of each part string in the price book.

## LFIC Double Cylinder Maxum – Commercial Trim

Description	Part Number	M <sup>3</sup>	BiLevel	X4	Biax/Orig	KeyMark
LFIC Double Cylinder Maxum Deadbolt Lock, 1" Faceplate, 2 3/8" Backset	11C323 (P)	\$478.00			\$496.98	
	11C323 (S)	\$452.00			\$470.98	
LFIC Double Cylinder Maxum Deadbolt Lock, Less Bolt	11C32L (P)	\$409.90			\$428.88	
	11C32L (S)	\$383.90			\$402.88	
LFIC Double Cylinder Maxum Deadbolt Lock, 1" Faceplate, 2 3/4" Backset	11C324 (P)	\$478.00			\$496.98	
	11C324 (S)	\$452.00			\$470.98	
LFIC Double Cylinder Maxum Deadbolt Lock, 1 1/8" Faceplate, 2 3/8" Backset	11C321 (P)	\$478.00			\$496.98	
	11C321 (S)	\$452.00			\$470.98	
LFIC Double Cylinder Maxum Deadbolt Lock, 1 1/8" Faceplate, 2 3/4" Backset	11C322 (P)	\$478.00			\$496.98	
	11C322 (S)	\$452.00			\$470.98	
LFIC Double Cylinder Maxum Deadbolt Lock, Drive-In Front, 2 3/8" Backset	11C325 (P)	\$478.00			\$478.00	
	11C325 (S)	\$452.00			\$470.98	
LFIC Double Cylinder Maxum Deadbolt Lock, Drive-In Front, 2 3/4" Backset	11C326 (P)	\$478.00			\$496.98	
	11C326 (S)	\$452.00			\$470.98	
LFIC Double Cylinder Maxum Deadbolt Lock, 1 1/8" Faceplate, Less Core, 2 3/8" Backset	11C421	\$214.00			\$214.00	
LFIC Double Cylinder Maxum Deadbolt Lock, 1 1/8" Faceplate, Less Core, 2 3/4" Backset	11C422	\$214.00			\$214.00	
LFIC Double Cylinder Maxum Deadbolt Lock, Drive-In Front, Less Core, 2 3/8" Backset	11C425	\$214.00			\$214.00	
LFIC Double Cylinder Maxum Deadbolt Lock, Drive-In Front, Less Core, 2 3/4" Backset	11C426	\$214.00			\$214.00	

\*\*Refer to the eCylinder section for more detail on specific technologies available and pricing. Technologies are represented by the following letters:  
T = Medeco<sup>3</sup>, S = M<sup>3</sup> CLIQ, J = Medeco<sup>3</sup> BiLevel, W = Biaxial, V = Medeco Biaxial CLIQ, K = Medeco KM, N = Medeco X4, C = Classic CLIQ, M = Medeco X4 CLIQ,  
"." = Original, Z = Medeco Original KW CLIQ, G = Medeco XT \*\*\*See key section for surcharges for custom coined cut keys or special stamping requirements.  
**Note:** (P) refers to **Pinned** and (S) to **Sub-Assembled** at the end of each part string in the price book.

## SFIC Double Cylinder Maxum – Commercial Trim

Description	Part Number	M <sup>3</sup>	BiLevel	X4	Biax/Orig	KeyMark
SFIC Double Cylinder Maxum Deadbolt Lock, 1 1/8" Faceplate, Less Core, 2 3/8" Backset	11C721	\$204.00			\$204.00	
SFIC Double Cylinder Maxum Deadbolt Lock, 1 1/8" Faceplate, Less Core, 2 3/4" Backset	11C722	\$204.00			\$204.00	
SFIC Double Cylinder Maxum Deadbolt Lock, 1" Faceplate, Less Core, 2 3/8" Backset	11C723	\$204.00			\$204.00	
SFIC Double Cylinder Maxum Deadbolt Lock, 1" Faceplate, Less Core, 2 3/4" Backset	11C724	\$204.00			\$204.00	
SFIC Double Cylinder Maxum Deadbolt Lock, Drive-In Front, Less Core, 2 3/8" Backset	11C725	\$204.00			\$204.00	
SFIC Double Cylinder Maxum Deadbolt Lock, Drive-In Front, Less Core, 2 3/4" Backset	11C726	\$204.00			\$204.00	
SFIC Double Cylinder Maxum Deadbolt Lock, 1 1/8" Faceplate, 6 Pin Cylinder, 2 3/8" Backset	11C821 (P)			\$347.00		\$360.48
	11C821 (S)			\$321.00		\$334.48
SFIC Double Cylinder Maxum Deadbolt Lock, 1 1/8" Faceplate, 6 Pin Cylinder, 2 3/4" Backset	11C822 (P)			\$347.00		\$360.48
	11C822 (S)			\$321.00		\$334.48
SFIC Double Cylinder Maxum Deadbolt Lock, 1" Faceplate, 6 Pin Cylinder, 2 3/8" Backset	11C823 (P)			\$347.00		\$360.48
	11C823 (S)			\$321.00		\$334.48
SFIC Double Cylinder Maxum Deadbolt Lock, 1" Faceplate, 6 Pin Cylinder	11C824 (P)			\$347.00		\$360.48
	11C824 (S)			\$321.00		\$334.48
SFIC Double Cylinder Maxum Deadbolt Lock, Drive-In Front, 6 Pin Cylinder, 2 3/8" Backset	11C825 (P)			\$347.00		\$360.48
	11C825 (S)			\$321.00		\$334.48
SFIC Double Cylinder Maxum Deadbolt Lock, Drive-In Front, 6 Pin Cylinder, 2 3/4" Backset	11C826 (P)			\$347.00		\$360.48
	11C826 (S)			\$321.00		\$334.48
SFIC Double Cylinder Maxum Deadbolt Lock, 1 1/8" Faceplate, 7 Pin Cylinder, 2 3/8" Backset	11C921 (P)			\$347.00		\$360.48
	11C921 (S)			\$321.00		\$334.48
SFIC Double Cylinder Maxum Deadbolt Lock, 1 1/8" Faceplate, 7 Pin Cylinder, 2 3/4" Backset	11C922 (P)			\$347.00		\$360.48
	11C922 (S)			\$321.00		\$334.48
SFIC Double Cylinder Maxum Deadbolt Lock, 1" Faceplate, 7 Pin Cylinder, 2 3/8" Backset	11C923 (P)			\$347.00		\$360.48
	11C923 (S)			\$321.00		\$334.48
SFIC Double Cylinder Maxum Deadbolt Lock, 1" Faceplate, 7 Pin Cylinder, 2 3/4" Backset	11C924 (P)			\$347.00		\$360.48
	11C924 (S)			\$321.00		\$334.48
SFIC Double Cylinder Maxum Deadbolt Lock, Drive-In Front, 7 Pin Cylinder, 2 3/8" Backset	11C925 (P)			\$347.00		\$360.48
	11C925 (S)			\$321.00		\$334.48
SFIC Double Cylinder Maxum Deadbolt Lock, Drive-In Front, 7 Pin Cylinder, 2 3/4" Backset	11C926 (P)			\$347.00		\$360.48
	11C926 (S)			\$321.00		\$321.00

## Interchangeable Core Cylinders for Maxum® Deadbolts

Description	Part Number	M <sup>3</sup>	BiLevel	X4	Biax/Orig	KeyMark
6 pin LFIC Cylinder	320201 (P)	\$144.00	\$78.30	\$100.30	\$149.50	
	320201 (S)	\$131.00	\$71.39	\$87.30	\$136.50	
6 Pin SFIC Cylinder	33600006 (P)			\$71.20		\$73.64
	33600006 (S)			\$58.20		\$60.64
7 Pin SFIC Cylinder	33700006 (P)			\$71.20		\$73.64
	33700006 (S)			\$58.20		\$60.64

\*\*Refer to the eCylinder section for more detail on specific technologies available and pricing. Technologies are represented by the following letters:

T = Medeco<sup>3</sup>, S = M<sup>3</sup> CLIQ, J = Medeco<sup>3</sup> BiLevel, W = Biaxial, V = Medeco Biaxial CLIQ, K = Medeco KM, N = Medeco X4, C = Classic CLIQ, M = Medeco X4 CLIQ, ". = Original, Z = Medeco Original KW CLIQ, G = Medeco XT \*\*\*See key section for surcharges for custom coined cut keys or special stamping requirements.

**Note:** (P) refers to Pinned and (S) to Sub-Assembled at the end of each part string in the price book.

**Maxum Deadbolt Cylinder Assemblies**

Description	Part Number	M <sup>3</sup>	BiLevel	X4	Biax/Orig	KeyMark
5 Pin Outside Cylinder Assembly	110A00 (P)	\$124.00				
	110A00 (S)	\$111.00				
5 Pin Inside Cylinder Assembly	110A01 (P)	\$124.00				
	110A01 (S)	\$111.00				
5 Pin Outside Captive Cylinder Assembly	110A02 (P)	\$130.00				
	110A02 (S)	\$117.00				
5 Pin Inside Captive Cylinder Assembly	110A03 (P)	\$130.00				
	110A03 (S)	\$117.00				
6 Pin Outside Cylinder Assembly	110A04 (P)	\$124.00	\$101.25		\$128.66	
	110A04 (S)	\$111.00	\$94.35		\$115.66	
6 Pin Inside Cylinder Assembly	110A05 (P)	\$124.00	\$101.25		\$128.66	
	110A05 (S)	\$111.00	\$94.35		\$115.66	
6 Pin Outside Captive Cylinder Assembly	110A06 (P)	\$130.00			\$134.91	
	110A06 (S)	\$117.00			\$121.91	
6 Pin Inside Captive Cylinder Assembly	110A07 (P)	\$130.00			\$134.91	
	110A07 (S)	\$117.00			\$121.91	

**Cylinder Housing & Plugs for Maxum Deadbolt**

Description	Part Number	M <sup>3</sup>	BiLevel	X4	Biax/Orig	KeyMark
LFIC Outside Cylinder Housing for Maxum Deadbolt Lock	110A08L	\$95.10				
LFIC Inside Cylinder Housing for Maxum Deadbolt Lock	110A09L	\$118.00				
6 Pin Plug for Maxum D.bolt (except Inside Captive Thumbturn)	1202800	\$50.20				
6 Pin Plug for Maxum Deadbolt Inside Captive Thumbturn	1202900	\$50.20				

**Bolt Assemblies for Maxum® Deadbolt**

Description	Part Number	M <sup>3</sup>	BiLevel	X4	Biax/Orig	KeyMark
2 3/8" Maxum Bolt 1" X 2 1/4" Faceplate	110A1911	\$68.50				
2 3/8" Maxum Bolt 1 1/8" X 2 1/4" Faceplate	110A1912	\$68.50				
2 3/8" Maxum Drive-in Bolt (Available in 26 finish only)	110A1913	\$68.50				
2 3/4" Maxum Bolt 1" X 2 1/4" Faceplate	110A1921	\$68.50				
2 3/4" Maxum Bolt 1 1/8" X 2 1/4" Faceplate	110A1922	\$68.50				
2 3/4" Maxum Drive-in Bolt (Available in 26 finish only)	110A1923	\$68.50				
5 Pack Round Front Assembly For Maxum Drive-In Bolt (Includes: CP-180961-26 and CP-011016-020)	94-0058-MED	\$147.00				
Round Front Assembly For Maxum Drive-In Bolt (Includes: CP-180961-26 and CP-011016-020)	94-0059	\$35.80				

\*\*Refer to the eCylinder section for more detail on specific technologies available and pricing. Technologies are represented by the following letters:  
T = Medeco<sup>3</sup>, S = M<sup>3</sup> CLIQ, J = Medeco<sup>3</sup> BiLevel, W = Biaxial, V = Medeco Biaxial CLIQ, K = Medeco KM, N = Medeco X4, C = Classic CLIQ, M = Medeco X4 CLIQ,  
"." = Original, Z = Medeco Original KW CLIQ, G = Medeco XT \*\*\*See key section for surcharges for custom coined cut keys or special stamping requirements.  
**Note:** (P) refers to **Pinned** and (S) to **Sub-Assembled** at the end of each part string in the price book.



## Maxum Deadbolt Components

Description	Part Number	Price
6 Pin Length Deadbolt Lock Outside Dummy Cylinder	11-0A16	\$63.80!
Residential Blank Inside Plate Assembly for Maxum® Deadbolt Lock	11-0A17	\$42.30
5 Pin Length Deadbolt Lock Outside Dummy Cylinder	11-0A18	\$63.80
Commercial Blank Inside Plate Assembly for Maxum® Deadbolt Lock	11-0A14	\$42.30
Residential Style Thumbturn To Fit On Captive Thumbturn Key (Original/Biaxial)	11-0A20	\$32.40
Residential Style Thumbturn To Fit On Captive Thumbturn Key (Medeco <sup>3</sup> )	11-0A21	\$32.40
Commercial Thumbturn and Base Plate Assembly	11-0A12	\$81.60
Commercial Style Thumbturn To Fit On Captive Thumbturn Key (Medeco <sup>3</sup> )	11-0018	\$32.40
Commercial Thumbturn & set screw	11-0A22	\$47.00
Residential Thumbturn & set screw	11-0A23	\$47.00
Residential Thumbturn and Base Plate Assembly	11-0A10	\$81.60
Commercial Style Thumbturn To Fit On Captive Thumbturn Key (Original/Biaxial)	11-0092	\$32.40
Thumbturn Trim Plate Package for Maxum Deadbolt Lock	940210	\$7.90
Inside Cylinder Trim Plate Package for Commercial Maxum® I/C Deadbolt Lock (includes CP-021090 & CP-180141)	94-0030	\$6.90
Spacer Rings for 1 3/8" Door for Maxum Deadbolt Lock (Package of 2)	94-0212	\$38.60
Inside Cylinder Trim Plate Package for Maxum Double Cylinder Deadbolt Lock (Includes CP-021090 & CP-180131)	94-0029	\$6.90
#8 x 2" FHWS Strike Box mounting screws	CP-010234-320	\$0.71
#8 x 3/4" comb. Wood/Machine S Bolt & Strike mounting screws	CP-010235-120-XX	\$0.71
Screw Package for 5 and 6 Pin Single Cylinder Maxum Deadbolt Lock	CP-011762	\$17.30
Screw Package for 5 Pin Double Cylinder Maxum Deadbolt Lock	CP-011763	\$17.30
Screw Package for 6 Pin Double Cylinder Maxum Deadbolt Lock	CP-011764	\$17.30
Screw Package for Blank x Thumbturn Maxum Deadbolt Lock	CP-011751	\$17.30
Screw Package for Blank x Cylinder Maxum Deadbolt Lock	CP-011767	\$17.30
Screw Package for Blank x Thumbturn Maxum Deadbolt Lock for 2 1/4" - 2 1/2" thick door	CP-011753	\$8.80
Screw Package for Blank x Cylinder Maxum Deadbolt Lock for 2 1/4" - 2 1/2" thick door	CP-011754	\$8.80
Screw Package for 6 Pin Classroom Function Maxum Deadbolt Lock	CP-011757	\$17.30
Collar for Maxum Residential Style Deadbolt Lock 5 Pin	CP-070691	\$62.10
Collar for Maxum Residential Style Deadbolt Lock 6 Pin	CP-070701	\$62.10

\*\*Refer to the eCylinder section for more detail on specific technologies available and pricing. Technologies are represented by the following letters:  
T = Medeco<sup>3</sup>, S = M<sup>3</sup> CLIQ, J = Medeco<sup>3</sup> BiLevel, W = Biaxial, V = Medeco Biaxial CLIQ, K = Medeco KM, N = Medeco X4, C = Classic CLIQ, M = Medeco X4 CLIQ,  
"." = Original, Z = Medeco Original KW CLIQ, G = Medeco XT \*\*\*See key section for surcharges for custom coined cut keys or special stamping requirements.  
**Note:** (P) refers to **Pinned** and (S) to **Sub-Assembled** at the end of each part string in the price book.



**Maxum Deadbolt Components**

Description	Part Number	Price
Collar for Maxum Commercial Style Deadbolt Lock (Inside & Outside)	CP-070711	\$62.10
Collar for Maxum Residential Style Deadbolt Lock Thick Door Captive Thumbturn 5 Pin	CP-070721	\$62.10
Collar for Maxum Residential Style Deadbolt Lock Thick Door Captive Thumbturn 6 Pin	CP-070731	\$62.10
Collar for Maxum Commercial Style Deadbolt Lock Thick Door Captive Thumbturn	CP-070741	\$62.10
Strike for Maxum Deadbolt Lock	CP-180061	\$15.80
Ball bearings (Allen head of mounting screws) .191" diameter silver	CP-250010	\$0.21
Ball bearings (tip of mounting screws) .202" diameter black	CP-250020	\$0.21
Strike Reinforcement Strike Box for Maxum Deadbolt Lock	CP-280620	\$5.30
Keyblank for Captive Thumbturn Key for Maxum Deadbolt 6 Pin, varies by Key Section (factory will supply correct part number)	KYB XX6605	\$11.20

**Maxum® Deadbolt Tailpieces**

Description	Part Number	Price
Thumbturn Tailpiece for Maxum Deadbolt lock for 1 3/4" - 2 1/2" thick door	CT-F42	\$6.90
Thumbturn Tailpiece for Classroom Function Maxum Deadbolt lock, 1 3/4" - 2" thick doors	CT-F43	\$6.90
Thumbturn Tailpiece for Classroom Function Maxum Deadbolt lock for doors 2 1/4" - 2 1/2" thick	CT-F44	\$6.90
Tailpiece for Maxum Deadbolt lock, outside cylinder, .532" length, for doors up to 1 3/4" thick	CT-Y60	\$2.60
Tailpiece for Maxum Deadbolt outside cylinder, 1.430" length for doors over 1 3/4" thick	CT-Y61	\$2.60

\*\*Refer to the eCylinder section for more detail on specific technologies available and pricing. Technologies are represented by the following letters:  
T = Medeco<sup>3</sup>, S = M<sup>3</sup> CLIQ, J = Medeco<sup>3</sup> BiLevel, W = Biaxial, V = Medeco Biaxial CLIQ, K = Medeco KM, N = Medeco X4, C = Classic CLIQ, M = Medeco X4 CLIQ,  
"." = Original, Z = Medeco Original KW CLIQ, G = Medeco XT \*\*\*See key section for surcharges for custom coined cut keys or special stamping requirements.

**Note:** (P) refers to **Pinned** and (S) to **Sub-Assembled** at the end of each part string in the price book.

# Medeco Maxum<sup>®</sup> Residential Deadbolt

Designed with a residential aesthetic, the ANSI Grade 1 Maxum deadbolt offers superior physical protection from breaking and attack. Available as a single-cylinder, double-cylinder or with a unique “captive thumbturn” cylinder, the Medeco<sup>3</sup> cylinder provides triple locking security from picking and key duplication. The captive thumbturn converts the inside cylinder to a thumbturn for safe exit when the facility is occupied. A quick conversion when the facility is not occupied returns it to double cylinder mode and guards against unauthorized entry or exit. Maxum<sup>®</sup> deadbolts offer maximum protection with solid-brass construction, along with anti-drilling and anti-prying features.



### Patented Key Control

Protects against unauthorized duplication of your keys.



### Certified Grade 1

BHMA certified Grade 1, passes to the highest standards in the industry.



### Drill Protection

Offers maximum protection with solid-brass construction and strategically placed drill pins.



### Protection From Physical Attack

The Medeco<sup>3</sup> Maxum Deadbolts are UL 437 Listed and stand up to prying, picking and other forms of physical attack.



### Special Angle Cut Keys

Requires a special key cutting machine and access to Medeco specific blanks, available in a variety of restrictions to support every need.



### Picking and Bumping Protection

Medeco<sup>3</sup> cylinders use a sidebar that prevent the key from rotating until it is elevated, rotated and aligned in the correct position. This feature protects against bumping and picking attacks.

## Technical Information:

- SFIC cylinder options include Medeco X4 and Medeco XT
- Unique “captive thumbturn” option available
- Bolt is designed for easy conversion accommodating either mortise or drive-in applications
- Solid-brass construction with steel inserts for added protection

- ANSI/BHMA A156.30 and UL437 Listed cylinders for high security
- Fits doors 1 3/8” to 2 1/2” thick
- Standard 2 1/8” crossbore and 1” edge bore (ANSI A115.13 prep)

## Warranty:

Warranted for two (2) years against manufacturer's defects. See the Medeco<sup>®</sup> Limited Warranty for full details.

## Finishes:

Available in all standard finishes to match existing hardware.

## Applications:

It is the ideal choice for a wide variety of commercial and heavy duty residential applications where consistent quality, ease of use and installation are required. Ideal applications include:

- Apartments
- Retail outlets
- Residences
- Multi-family Units

## Available Key Technologies:

### Mechanical:

- Medeco<sup>3</sup>
- Medeco<sup>3</sup> BiLevel
- Medeco X4

### eCylinder:

- M<sup>3</sup> CLIQ
- Classic CLIQ

## Single Cylinder Maxum Deadbolt – Residential Trim

Description	Part Number	M <sup>3</sup>	BiLevel	X4	Biax/Orig	KeyMark
5 Pin Single Cylinder Deadbolt, 1" Faceplate, 2-3/8" Backset	11R503 (P)	\$228.00	\$189.65		\$237.03	
	11R503 (S)	\$215.00	\$182.75		\$224.03	
5 Pin Single Cylinder Deadbolt, 1" Faceplate, 2-3/4" Backset	11R504 (P)	\$228.00	\$189.65		\$237.03	
	11R504 (S)	\$215.00	\$182.75		\$224.03	
6 Pin Single Cylinder Deadbolt, 1" Faceplate, 2-3/8" Backset	11R603 (P)	\$228.00	\$189.65		\$237.03	
	11R603 (S)	\$215.00	\$182.75		\$224.03	
6 Pin Single Cylinder Deadbolt, 1" Faceplate, 2-3/4" Backset	11R604 (P)	\$228.00	\$189.65		\$237.03	
	11R604 (S)	\$215.00	\$182.75		\$224.03	
Single Dummy Trim Deadbolt (5 Pin Length)	11R57L	\$173.90			\$173.90	
Single Dummy Trim Deadbolt (6 Pin Length)	11R67L	\$173.90			\$173.90	

## Double Cylinder Maxum Deadbolt – Residential Trim

Description	Part Number	M <sup>3</sup>	BiLevel	X4	Biax/Orig	KeyMark
5 Pin Double Cylinder Deadbolt 1" Faceplate, 2 3/8" Backset	11R523 (P)	\$316.00	\$260.30		\$328.18	
	11R523 (S)	\$290.00	\$246.50		\$302.18	
5 Pin Double Cylinder Deadbolt 1" Faceplate, 2 3/4" Backset	11R524 (P)	\$316.00	\$260.30		\$328.18	
	11R524 (S)	\$290.00	\$246.50		\$302.18	
6 Pin Double Cylinder Deadbolt, 1" Faceplate, 2 3/8" Backset	11R623 (P)	\$316.00	\$260.30		\$328.18	
	11R623 (S)	\$290.00	\$246.50		\$302.18	
6 Pin Double Cylinder Deadbolt, 1" Faceplate, 2 3/4" Backset	11R624 (P)	\$316.00	\$260.30		\$328.18	
	11R624 (S)	\$290.00	\$246.50		\$302.18	
Double Dummy Trim Deadbolt (5 Pin Length)	11R5DL	\$231.90			\$231.90	
Double Dummy Trim Deadbolt (6 Pin Length)	11R6DL	\$231.90			\$231.90	

## Double Cyl. Captive Thumbturn Maxum – Residential Trim

Description	Part Number	M <sup>3</sup>	BiLevel	X4	Biax/Orig	KeyMark
5 Pin Captive Thumbturn Double Cylinder Deadbolt, 2 3/8" Backset	11R533 (P)	\$357.00	\$295.15		\$370.90	
	11R533 (S)	\$331.00	\$281.35		\$344.90	
5 Pin Captive Thumbturn Double Cylinder Deadbolt, 2 3/4" Backset	11R534 (P)	\$357.00	\$295.15		\$370.90	
	11R534 (S)	\$331.00	\$281.35		\$344.90	
6 Pin Captive Thumbturn Double Cylinder Deadbolt, 1" Faceplate, 2 3/8" Backset	11R633 (P)	\$357.00	\$295.15		\$370.90	
	11R633 (S)	\$331.00	\$281.35		\$344.90	
6 Pin Captive Thumbturn Double Cylinder Deadbolt, 1" Faceplate, 2 3/4" Backset	11R634 (P)	\$357.00	\$295.15		\$370.90	
	11R634 (S)	\$331.00	\$281.35		\$344.90	

## Cylinder Plugs for Maxum – Residential Deadbolts

Description	Part Number	M <sup>3</sup>	BiLevel	X4	Biax/Orig	KeyMark
6 pin plug for Maxum Residential Deadbolt (except inside captive thumbturn)	1202800	\$50.20				
6 pin plug for Maxum Residential Deadbolt inside captive thumbturn	1202900	\$50.20				
5 pin plug for Maxum Residential Deadbolt (except inside captive thumbturn)	1236200	\$52.31				
5 pin plug for Maxum Residential Deadbolt inside captive thumbturn	1243400	\$50.20				

\*\*Refer to the eCylinder section for more detail on specific technologies available and pricing. Technologies are represented by the following letters:  
T = Medeco<sup>3</sup>, S = M<sup>3</sup> CLIQ, J = Medeco<sup>3</sup> BiLevel, W = Biaxial, V = Medeco Biaxial CLIQ, K = Medeco KM, N = Medeco X4, C = Classic CLIQ, M = Medeco X4 CLIQ,  
“-” = Original, Z = Medeco Original KW CLIQ, G = Medeco XT \*\*\*See key section for surcharges for custom coined cut keys or special stamping requirements.  
**Note:** (P) refers to Pinned and (S) to Sub-Assembled at the end of each part string in the price book.

# Padlocks

FEATURES	Medeco <sup>3</sup>	BiLevel	Medeco X4	CLIQ	Medeco XT	Nexgen
<b>Protector II</b>						
Protector II body accepts 6 pin knob style cylinders	●		●	●	●	
Protector II is available as key retaining only	●		●	●	●	
<b>System Series</b>						
System Series body accepts knob style cylinders	●	●	●	●	●	
System Series body accepts large format interchangeable cylinders	●	●		●		
System Series body accepts 6 or 7 pin small format interchangeable cores			●		●	
Non-key retaining and key retaining models available	●	●	●	●	●	
<b>Hockey Puck</b>						
Hockey Puck body accepts knob style 5 pin cylinder	●	●				
Hockey Puck body accepts knob style 6 pin cylinder			●			
Hockey Puck is available as non- key retaining only	●	●	●		●	
<b>G8R</b>						
G8R body accepts a pop-out cylinder	●			●	●	●
Sold less cylinder	●			●	●	●
<b>All Padlocks</b>						
UL437 Listing & BHMA Certification for high security	●					
Easily integrated into master key systems for key security and convenience	●	●	●			
Patented key control to protect against unauthorized duplication	●	●	●			

## Medeco<sup>3</sup> Premium High Security

For effective mechanical protection against most forms of attack as well as protection against unauthorized duplicate keys, Medeco<sup>3</sup> cylinders are recommended. Security features including hardened steel components, pins that must be elevated, rotated, and interact with both a sidebar and a slider, and additional pick resistant features make Medeco<sup>3</sup> the cylinder of choice to protect people, property and information.

## Medeco<sup>3</sup> BiLevel Patented Key Control

Medeco<sup>3</sup> BiLevel cylinders may be incorporated into a master key system with Medeco<sup>3</sup> high security, offering protection against all types of attack where needed, and patented key control cylinders for areas requiring less protection. BiLevel cylinders offer patented control against unauthorized duplication of keys without the additional security features protecting against force or surreptitious attack.

## Medeco X4 Patented Key Control

Medeco X4 cylinders offer patented control against unauthorized duplication of keys without the additional security features protecting against force or surreptitious attack.

## Intelligent Key Solutions

Many of the cylinders in this section are also available with an Intelligent Key solution. See the Intelligent Key section for more details.

## How to Order The Protector II Padlock:

<p><b>1</b></p> <p><b>50047320</b> base part #</p> <p>Refer to page 157 for descriptions and technical specifications to find the corresponding base part number.</p>	<p><b>2</b></p> <p><b>T</b> cylinder</p> <p>- = Original T = Medeco<sup>3</sup> W = Biaxial S = M<sup>3</sup> CLIQ G = Medeco XT N = Medeco X4</p>	<p><b>3</b></p> <p><b>LT</b> keyway</p> <p>Insert keyway if known or contact Customer Service for help.</p>	<p><b>4</b></p> <p><b>S</b> pinning</p> <table border="1"> <tr> <td style="vertical-align: top;"> <p>S = <b>Sub-Assembled</b> <b>(Uncombined)</b> No additional information needed</p> </td> <td style="vertical-align: top;"> <p>P = <b>Pinned (Combined)</b> Keyed alike (KA) Keyed different (KD) 2 keys per cylinder</p> </td> <td style="vertical-align: top;"> <p>M = <b>Master Keyed</b> Provide specific pinning or contact Customer Service for support Must specify quantity for keys.</p> </td> </tr> </table>	<p>S = <b>Sub-Assembled</b> <b>(Uncombined)</b> No additional information needed</p>	<p>P = <b>Pinned (Combined)</b> Keyed alike (KA) Keyed different (KD) 2 keys per cylinder</p>	<p>M = <b>Master Keyed</b> Provide specific pinning or contact Customer Service for support Must specify quantity for keys.</p>
<p>S = <b>Sub-Assembled</b> <b>(Uncombined)</b> No additional information needed</p>	<p>P = <b>Pinned (Combined)</b> Keyed alike (KA) Keyed different (KD) 2 keys per cylinder</p>	<p>M = <b>Master Keyed</b> Provide specific pinning or contact Customer Service for support Must specify quantity for keys.</p>				

### BUILD A PROTECTOR II PADLOCK BASE PART #

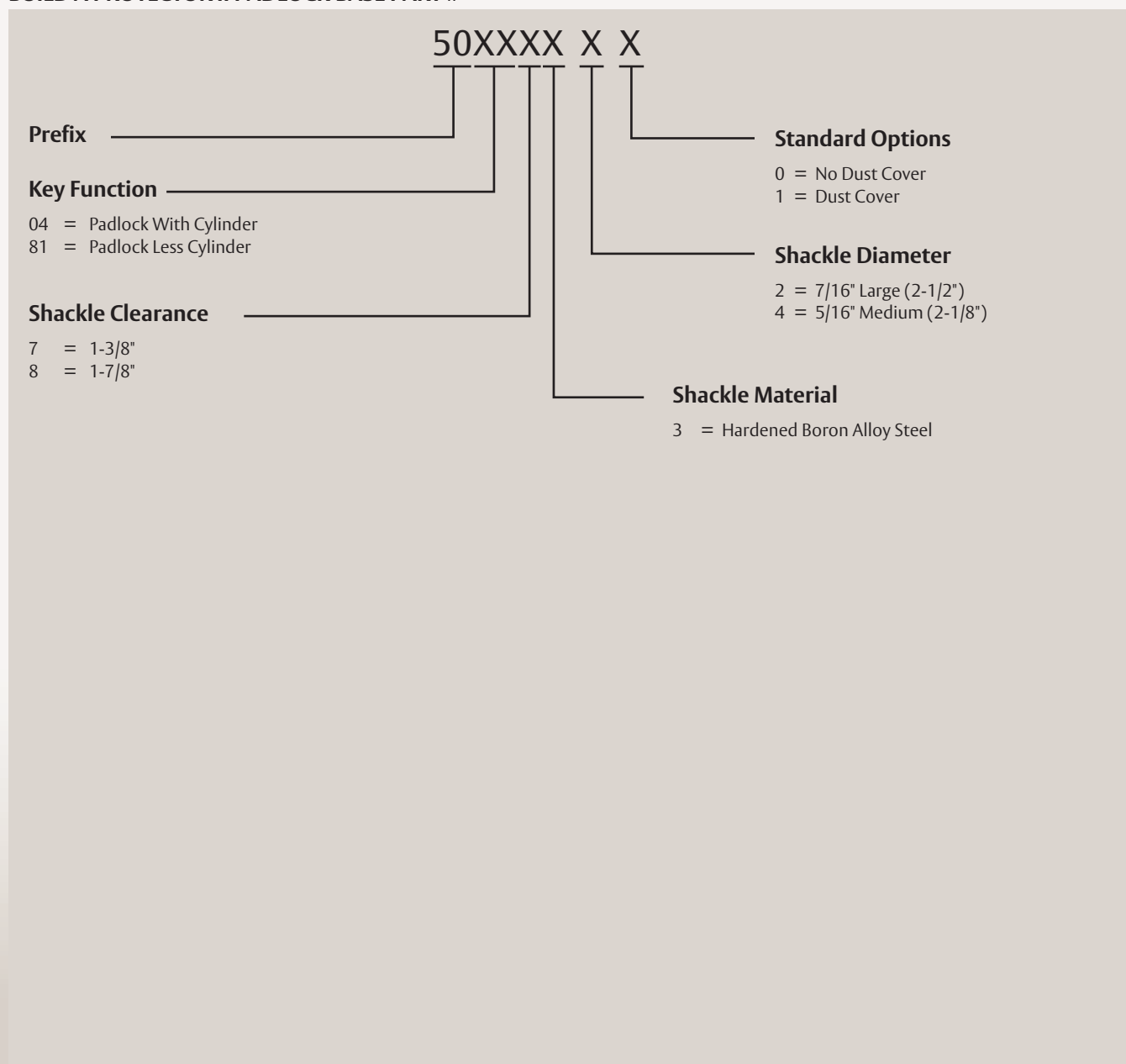

# Protector II Series Padlocks

The Protector II Series padlock is made of durable, industrial grade stainless steel and offers excellent resistance to severe service conditions.

The hardened boron alloy steel shackles stand up to physical attack, providing strong resistance against cutting, sawing and prying. The patented Medeco<sup>3</sup> mechanical cylinder resists picking, drilling and other sophisticated forms of physical attack. Also available in eCylinder formats for Loss and Liability Control.



## Patented Key Control

Protects against unauthorized duplication of keys.



## Special Angled Key Cuts

Requires a special key cutting machine and access to Medeco specific blanks, available in a variety of restrictions to support every need.



## Can Be Master Keyed

Medeco Protector II Padlocks can be master keyed into a system containing Medeco<sup>3</sup> mechanical as well as M<sup>3</sup> CLIQ or XT eCylinders.



## Protection From Shackle Attack

Hardened boron alloy steel shackles (5/16" and 7/16" diameters) provide strong resistance against cutting, sawing and prying. Available in both 1 3/8" and 1 7/8" lengths.



## Proprietary Deadlocking Shackle

Unique deadlocking shackle locking mechanism for resistance to physical attack.



## Protection From Physical Attack

Medeco<sup>3</sup> cylinders are UL 437 listed and resists drilling, picking and other forms of physical attack.



## Picking and Bumping Protection

Medeco<sup>3</sup> cylinders use a sidebar that prevents the key from rotating until the tumbler pins are elevated, rotated and aligned in the correct position. This feature protects against bumping and picking attacks.

## Benefits:

- Hardened stainless steel inserts inside the cylinder provide the ultimate defense against drilling and other forms of physical attack.
- Unique elevating and rotating tumbler pin system is virtually pick proof.
- All Medeco<sup>®</sup> cylinders are constructed of durable machined brass components, designed to last the life of your equipment.
- Patented Medeco<sup>3</sup> keys may only be duplicated by Medeco or an authorized Medeco service outlet, and only at your request.
- Boron alloy steel shackle which protects against cutting and pulling attacks.
- Locks can be keyed alike, keyed different, or master keyed depending on your specific needs.

## Applications:

The Medeco Protector II padlocks can be used in a variety of different indoor or outdoor applications where high security and key control are a primary concern.

## Technical Features:

- Uses key retaining operation.
- Uses a dedicated 6 pin KIK/KIL cylinder that can be pinned to 5.

## Warranty:

Warranted for two (2) years against manufacturer's defects. See the Medeco limited warranty for full details.

## Finishes:

The padlock comes in a standard industrial stainless steel finish and the cylinders are furnished in the satin brass finish.

## Available Key Technologies:

<b>Mechanical:</b>	<b>eCylinder:</b>
– Medeco <sup>3</sup>	– M <sup>3</sup> CLIQ
– Medeco X4	– Medeco XT

**Protector II Series Padlocks**

Description	Part Number	M <sup>3</sup>	BiLevel	X4	Biax/Orig	KeyMark
Large Body - 7/16" dia shackle, Less Cyl, 1 3/8" clearance	50-81732	\$139.60				
Large Body - 7/16" dia shackle, Less Cyl, 1 3/8" clearance, Dust cover	50-817321	\$153.90				
Large Body - 7/16" dia shackle, Less Cyl, 1 7/8" clearance	50-81832	\$144.60				
Large Body - 7/16" dia shackle, Less Cyl, 1 7/8" clearance, Dust cover	50-818321	\$158.90				
Med Body - 5/16" dia shackle, Less Cyl, 1 3/8" clearance	50-81734	\$117.00				
Med Body - 5/16" dia shackle, Less Cyl, 1 3/8" clearance, Dust cover	50-817341	\$131.30				
Med Body - 5/16" dia shackle, Less Cyl, 1 7/8" clearance	50-81834	\$122.00				
Med Body - 5/16" dia shackle, Less Cyl, 1 7/8" clearance, Dust cover	50-818341	\$136.30				
Large Body - 7/16" dia shackle, 1 3/8" clearance	5004732 (P)	\$221.60			\$229.41	
	5004732 (S)	\$208.60			\$216.41	
Large Body - 7/16" dia shackle, 1 3/8" clearance, Dust cover	50047321 (P)	\$235.90			\$243.71	
	50047321 (S)	\$222.90			\$230.71	
Large Body - 7/16" dia shackle, 1 7/8" clearance	5004832 (P)	\$225.60			\$233.58	
	5004832 (S)	\$212.60			\$220.58	
Large Body - 7/16" dia shackle, 1 7/8" clearance, Dust cover	50048321 (P)	\$239.90			\$247.88	
	50048321 (S)	\$226.90			\$234.88	
Med Body - 5/16" dia shackle, 1 3/8" clearance	5004734 (P)	\$199.00			\$206.81	
	5004734 (S)	\$186.00			\$193.81	
Med Body - 5/16" dia shackle, 1 3/8" clearance, Dust cover	50047341 (P)	\$213.30			\$221.11	
	50047341 (S)	\$200.30			\$208.11	
Med Body - 5/16" dia shackle, 1 7/8" clearance	5004834 (P)	\$203.00			\$210.98	
	5004834 (S)	\$190.00			\$197.98	
Med Body - 5/16" dia shackle, 1 7/8" clearance, Dust cover	50048341 (P)	\$217.30			\$225.28	
	50048341 (S)	\$204.30			\$212.28	

**Protector II Series Padlock Cylinder**

Description	Part Number	M <sup>3</sup>	BiLevel	X4	Biax/Orig	KeyMark
KIK style cylinder for Protector II	500020 (P)	\$89.40			\$92.61	
	500020 (S)	\$76.40			\$79.61	

**Protector II Series Padlock Parts**

Description	Part Number	Price
Disk For Standard Key In Knob Cylinder	CP-171011	\$14.00
Disk For CLIQ Cylinder	CP-171021	\$14.00
Disk For Medeco XT Cylinder	CP-171031	\$14.00



## How to Order System Series Padlocks:

<b>1</b> <b>5451500</b> base part #  Refer to pages 162-167 for descriptions and technical specifications to find the corresponding base part number.	<b>2</b> <b>T</b> cylinder  - = Original T = Medeco <sup>3</sup> W = Biaxial J = Medeco <sup>3</sup> BiLevel C = Classic CLIQ N = Medeco X4 G = Medeco XT K = Medeco KM	<b>3</b> <b>06</b> finish  Insert 06 for Satin Brass finish.	<b>4</b> <b>LT</b> keyway  Insert keyway if known or contact Customer Service for help.	<b>5</b> <b>S</b> pinning  <table border="1"> <tr> <td> <b>S =</b>  <b>Sub-Assembled (Uncombined)</b>            No additional information needed         </td> <td> <b>P =</b>  <b>Pinned (Combined)</b>            Keyed alike (KA)            Keyed different (KD)            2 keys per cylinder         </td> <td> <b>M =</b>  <b>Master Keyed</b>            Provide specific pinning or contact Customer Service for support             Must specify quantity for keys.         </td> </tr> </table>	<b>S =</b> <b>Sub-Assembled (Uncombined)</b> No additional information needed	<b>P =</b> <b>Pinned (Combined)</b> Keyed alike (KA) Keyed different (KD) 2 keys per cylinder	<b>M =</b> <b>Master Keyed</b> Provide specific pinning or contact Customer Service for support  Must specify quantity for keys.
<b>S =</b> <b>Sub-Assembled (Uncombined)</b> No additional information needed	<b>P =</b> <b>Pinned (Combined)</b> Keyed alike (KA) Keyed different (KD) 2 keys per cylinder	<b>M =</b> <b>Master Keyed</b> Provide specific pinning or contact Customer Service for support  Must specify quantity for keys.					

### BUILD A SYSTEM SERIES PADLOCK BASE PART #

<b>54XXXX X X</b>	
<b>Prefix</b> _____	<b>Standard Options</b> Blank = None T = Thick Head (SFIC Only)
<b>Shackle (Diameter), Feature, Clearance</b>  315 = 5/16" Diameter, Weather, 1 1/8" SFIC 31F = 5/16" Diameter, Weather, 2 3/8" SFIC 325 = 5/16" Diameter, Shrouded, 3/4" SFIC 335 = 5/16" Diameter, Weather, 1 1/8" SFIC 7 Pin 33F = 5/16" Diameter, Weather, 2 3/8" SFIC 7 Pin 345 = 5/16" Diameter, Shrouded, 3/4" SFIC 7 Pin 415 = 7/16" Diameter, Weather, 1 3/8" SFIC 41F = 7/16" Diameter, Weather, 1 7/8" SFIC 425 = 7/16" Diameter, Shrouded, 3/4" SFIC 435 = 7/16" Diameter, Weather, 1 3/8" SFIC 7 Pin 43F = 7/16" Diameter, Weather, 1 7/8" SFIC 7 Pin 445 = 7/16" Diameter, Shrouded, 3/4" SFIC 7 Pin 515 = 5/16" Diameter, Weather, 1 1/8" KIK 51F = 5/16" Diameter, Weather, 2 3/8" KIK 525 = 5/16" Diameter, Shrouded, 3/4" KIK 615 = 5/16" Diameter, Weather, 1 1/8" LFIC 61F = 5/16" Diameter, Weather, 2 3/8" LFIC 625 = 5/16" Diameter, Shrouded, 3/4" LFIC 715 = 7/16" Diameter, Weather, 1 3/8" KIK 71F = 7/16" Diameter, Weather, 1 7/8" KIK 725 = 7/16" Diameter, Shrouded, 3/4" KIK 815 = 7/16" Diameter, Weather, 1 3/8" LFIC 81F = 7/16" Diameter, Weather, 1 7/8" LFIC 825 = 7/16" Diameter, Shrouded, 3/4" LFIC	<b>Shackle Material</b> 0 = Boron Alloy Steel 1 = Stainless Steel  <b>Key Function</b> 0 = Non-Key Retaining K = Less Cylinder (Key Retaining) L = Less Cylinder (Non-Key Retaining) R = Key Retaining

# System Series Padlocks

The Medeco® System Series padlock offers a high security solution for a multitude of applications and is available in two distinctive body styles, an indoor/outdoor weather resistant design or with a shrouded shackle. Both models utilize a boron alloy steel shackle which provides protection against cutting and increased tensile strength to resist pulling attacks.

The boron alloy steel also ensures that the shackle has an exceptional degree of ductility and is not brittle. The cylinder itself uses hardened, stainless steel inserts to provide the ultimate defense against drilling, pulling and other forms of vandal attack. The Medeco<sup>3</sup> unique design provides triple locking action, making the locks virtually pick proof. All Medeco<sup>3</sup> keys and locks are protected under patent, trademark, and copyright laws. Medeco<sup>3</sup> keys may only be duplicated by Medeco® or by a Medeco® authorized sales outlet, and only at your request.



## Patented Key Control

Protects against unauthorized duplication of your keys.



## Protection From Physical Attack

Medeco<sup>3</sup> padlock cylinders are UL 437 listed and stand up to drilling, picking and other forms of physical attack.



## Proprietary Deadlocking Shackle

Boron alloy steel shackles protect against cutting and pulling attacks.



## Can Be Master Keyed

Medeco System Series Padlocks can be master keyed into a system containing Medeco BiLevel and Medeco<sup>3</sup> mechanical as well as Medeco<sup>3</sup> CLIQ eCylinders.



## Available in eCylinder

System Series Padlocks are also available with Medeco eCylinders for Loss & Liability control.



## Special Angle Cut Keys

Requires a special key cutting machine and access to Medeco specific blanks, available in a variety of restrictions to support every need.



## Picking and Bumping Protection

Medeco<sup>3</sup> cylinders use a sidebar that prevent the key from rotating until it is elevated, rotated and aligned in the correct position. This feature protects against bumping and picking attacks.

## Technical Features:

- Available with either a 5/16 inch or a 7/16 inch shackle diameter.
- Available in Indoor/Outdoor weather resistant design or with a shrouded shackle.
- Extended shackles available for Indoor/Outdoor padlocks only.
- The shrouded shackle design provides extra shackle protection against cutting attacks.
- All Medeco® cylinders are constructed of durable machined brass components, designed to last the life of your equipment.
- Boron alloy steel shackle which protects against cutting and pulling attacks.
- Available in a variety of different shackle lengths.

## Applications:

Used in a variety of different indoor or outdoor applications where high security and key control are a primary concern.

## Warranty:

Warranted for two (2) years against manufacturer's defects. See the Medeco® limited warranty for full details.

## Finishes:

The padlock comes in a standard black body cover and the cylinders are furnished in satin brass finish.

## Available Key Technologies:

### Mechanical:

- Medeco<sup>3</sup>
- Medeco<sup>3</sup> BiLevel
- Medeco X4

### eCylinder:

- M<sup>3</sup> CLIQ
- Classic CLIQ
- Medeco XT
- Medeco X4 CLIQ

## Indoor/Outdoor Padlock, 5/16" Shackle -KIK

Description	Part Number	M <sup>3</sup>	BiLevel	X4	Biax/Orig	KeyMark
Indoor/Outdoor Padlock, Non-Key Retaining, 1 1/8" Shackle Clearance, With Cylinder	5451500 (P)	\$151.00	\$104.50	\$137.90	\$156.80	\$143.40
	5451500 (S)	\$138.00	\$97.60	\$124.90	\$143.80	\$130.40
Indoor/Outdoor Padlock, Key Retaining, 1 1/8" Shackle Clearance, With Cylinder	54515R0 (P)	\$151.00	\$104.50	\$137.90	\$156.80	\$143.40
	54515R0 (S)	\$138.00	\$97.60	\$124.90	\$143.80	\$130.40
Indoor/Outdoor Padlock, Non-Key Retaining, 2 3/8" Shackle Clearance, With Cylinder	5451F00 (P)	\$154.00	\$107.50	\$140.90	\$159.92	\$146.52
	5451F00 (S)	\$141.00	\$100.60	\$127.90	\$146.92	\$133.52
Indoor/Outdoor Padlock, Key Retaining, 2 3/8" Shackle Clearance, With Cylinder	5451FR0 (P)	\$154.00	\$107.50	\$140.90	\$159.92	\$146.52
	5451FR0 (S)	\$141.00	\$100.60	\$127.90	\$146.92	\$133.52
Indoor/Outdoor Padlock, Key Retaining, 1 1/8" Shackle Clearance, Less Cylinder	54515K0	\$49.60				
Indoor/Outdoor Padlock, Non-Key Retaining, 1 1/8" Shackle Clearance, Less Cylinder	54515L0	\$49.60				
Indoor/Outdoor Padlock, Key Retaining, 2 3/8" Shackle Clearance, Less Cylinder	5451FK0	\$52.60				
Indoor/Outdoor Padlock, Non-Key Retaining, 2 3/8" Shackle Clearance, Less Cylinder	5451FL0	\$52.60				

## Indoor/Outdoor Padlock, 5/16" Shackle -6 Pin LFIC

Description	Part Number	M <sup>3</sup>	BiLevel	X4	Biax/Orig	KeyMark
Indoor/Outdoor Padlock, Non-Key Retaining, 1 1/8" Shackle Clearance, With Cylinder	5461500 (P)	\$206.00	\$139.60		\$214.11	
	5461500 (S)	\$193.00	\$132.70		\$201.11	
Indoor/Outdoor Padlock, Key Retaining, 1 1/8" Shackle Clearance, With Cylinder	54615R0 (P)	\$206.00	\$139.60		\$214.11	
	54615R0 (S)	\$193.00	\$132.70		\$201.11	
Indoor/Outdoor Padlock, Non-Key Retaining, 2 3/8" Shackle Clearance, With Cylinder	5461F00 (P)	\$212.00	\$145.60		\$220.36	
	5461F00 (S)	\$199.00	\$138.70		\$207.36	
Indoor/Outdoor Padlock, Key Retaining, 2 3/8" Shackle Clearance, With Cylinder	5461FR0 (P)	\$212.00	\$145.60		\$220.36	
	5461FR0 (S)	\$199.00	\$138.70		\$207.36	
Indoor/Outdoor Padlock, Key Retaining, 1 1/8" Shackle Clearance, Less Cylinder	54615K0	\$52.00				
Indoor/Outdoor Padlock, Non-Key Retaining, 1 1/8" Shackle Clearance, Less Cylinder	54615L0	\$52.00				
Indoor/Outdoor Padlock, Key Retaining, 2 3/8" Shackle Clearance, Less Cylinder	5461FK0	\$58.00				
Indoor/Outdoor Padlock, Non-Key Retaining, 2 3/8" Shackle Clearance, Less Cylinder	5461FL0	\$58.00				

\*\*Refer to the eCylinder section for more detail on specific technologies available and pricing. Technologies are represented by the following letters:  
T = Medeco<sup>3</sup>, S = M<sup>3</sup> CLIQ, J = Medeco<sup>3</sup> BiLevel, W = Biaxial, V = Medeco Biaxial CLIQ, K = Medeco KM, N = Medeco X4, C = Classic CLIQ, M = Medeco X4 CLIQ,  
"-" = Original, Z = Medeco Original KW CLIQ, G = Medeco XT \*\*\*See key section for surcharges for custom coined cut keys or special stamping requirements.

**Note:** (P) refers to **Pinned** and (S) to **Sub-Assembled** at the end of each part string in the price book.

**Indoor/Outdoor Padlock, 5/16" Shackle -6 Pin SFIC**

Description	Part Number	M <sup>3</sup>	BiLevel	X4	Biax/Orig	KeyMark
Indoor/Outdoor Padlock, Non-Key Retaining, 1 1/8" Shackle Clearance, With Cylinder	5431500 (P)			\$129.90		\$129.60
	5431500 (S)			\$116.90		\$116.60
Indoor/Outdoor Padlock, Key Retaining, 1 1/8" Shackle Clearance, With Cylinder	54315R0 (P)			\$129.90		\$129.60
	54315R0 (S)			\$116.90		\$116.60
Indoor/Outdoor Padlock, Non-Key Retaining, 2 3/8" Shackle Clearance, With Cylinder	5431F00 (P)			\$134.90		\$140.27
	5431F00 (S)			\$121.90		\$127.27
Indoor/Outdoor Padlock, Key Retaining, 2 3/8" Shackle Clearance, With Cylinder	5431FR0 (P)			\$134.90		\$140.27
	5431FR0 (S)			\$121.90		\$127.27

**Indoor/Outdoor Padlock, 5/16" Shackle -7 Pin SFIC**

Description	Part Number	M <sup>3</sup>	BiLevel	X4	Biax/Orig	KeyMark
Indoor/Outdoor Padlock, Non-Key Retaining, 1 1/8" Shackle Clearance, With Cylinder	5433500 (P)			\$129.90		\$135.06
	5433500 (S)			\$116.90		\$122.06
Indoor/Outdoor Padlock, Key Retaining, 1 1/8" Shackle Clearance, With Cylinder	54335R0 (P)			\$129.90		\$135.06
	54335R0 (S)			\$116.90		\$122.06
Indoor/Outdoor Padlock, Non-Key Retaining, 2 3/8" Shackle Clearance, With Cylinder	5433F00 (P)			\$134.90		\$140.27
	5433F00 (S)			\$121.90		\$127.27
Indoor/Outdoor Padlock, Key Retaining, 2 3/8" Shackle Clearance, With Cylinder	5433FR0 (P)			\$134.90		\$140.27
	5433FR0 (S)			\$121.90		\$127.27

**Indoor/Outdoor Padlock, 5/16" Shackle -Less SFIC**

Description	Part Number	M <sup>3</sup>	BiLevel	X4	Biax/Orig	KeyMark
Indoor/Outdoor Padlock, Key Retaining, 1 1/8" Shackle Clearance, Less Cylinder	54315K0	\$51.00				
Indoor/Outdoor Padlock, Non-Key Retaining, 1 1/8" Shackle Clearance, Less Cylinder	54315L0	\$51.00				
Indoor/Outdoor Padlock, Key Retaining, 2 3/8" Shackle Clearance, Less Cylinder	5431FK0	\$56.00				
Indoor/Outdoor Padlock, Non-Key Retaining, 2 3/8" Shackle Clearance, Less Cylinder	5431FL0	\$56.00				

\*\*Refer to the eCylinder section for more detail on specific technologies available and pricing. Technologies are represented by the following letters:  
T = Medeco<sup>3</sup>, S = M<sup>3</sup> CLIQ, J = Medeco<sup>3</sup> BiLevel, W = Biaxial, V = Medeco Biaxial CLIQ, K = Medeco KM, N = Medeco X4, C = Classic CLIQ, M = Medeco X4 CLIQ,  
"." = Original, Z = Medeco Original KW CLIQ, G = Medeco XT \*\*\*See key section for surcharges for custom coined cut keys or special stamping requirements.  
**Note:** (P) refers to **Pinned** and (S) to **Sub-Assembled** at the end of each part string in the price book.

## Indoor/Outdoor Padlock, 7/16" Shackle -KIK

Description	Part Number	M <sup>3</sup>	BiLevel	X4	Biax/Orig	KeyMark
Indoor/Outdoor Padlock, Non-Key Retaining, 1 3/8" Shackle Clearance, With Cylinder	5471500 (P)	\$176.00	\$129.50	\$162.90	\$182.85	\$169.45
	5471500 (S)	\$163.00	\$122.60	\$149.90	\$169.85	\$156.45
Indoor/Outdoor Padlock, Key Retaining, 1 3/8" Shackle Clearance, With Cylinder	54715R0 (P)	\$176.00	\$129.50	\$162.90	\$182.85	\$169.45
	54715R0 (S)	\$163.00	\$122.60	\$149.90	\$169.85	\$156.45
Indoor/Outdoor Padlock, Non-Key Retaining, 1 7/8" Shackle Clearance, With Cylinder	5471F00 (P)	\$179.00	\$132.50	\$165.90	\$185.97	\$172.57
	5471F00 (S)	\$166.00	\$125.60	\$152.90	\$172.97	\$159.57
Indoor/Outdoor Padlock, Key Retaining, 1 7/8" Shackle Clearance, With Cylinder	5471FR0 (P)	\$179.00	\$132.50	\$165.90	\$185.97	\$172.57
	5471FR0 (S)	\$166.00	\$125.60	\$152.90	\$172.97	\$159.57
Indoor/Outdoor Padlock, Key Retaining, 1 3/8" Shackle Clearance, Less Cylinder	54715K0	\$74.60				
Indoor/Outdoor Padlock, Non-Key Retaining, 1 3/8" Shackle Clearance, Less Cylinder	54715L0	\$74.60				
Indoor/Outdoor Padlock, Key Retaining, 1 7/8" Shackle Clearance, Less Cylinder	5471FK0	\$77.60				
Indoor/Outdoor Padlock, Non-Key Retaining, 1 7/8" Shackle Clearance, Less Cylinder	5471FL0	\$77.60				

## Indoor/Outdoor Padlock, 7/16" Shackle -6 Pin LFIC

Description	Part Number	M <sup>3</sup>	BiLevel	X4	Biax/Orig	KeyMark
Indoor/Outdoor Padlock, Non-Key Retaining, 1 3/8" Shackle Clearance, With Cylinder	5481500 (P)	\$236.00			\$245.37	
	5481500 (S)	\$223.00			\$232.37	
Indoor/Outdoor Padlock, Key Retaining, 1 3/8" Shackle Clearance, With Cylinder	54815R0 (P)	\$236.00			\$245.37	
	54815R0 (S)	\$223.00			\$232.37	
Indoor/Outdoor Padlock, Non-Key Retaining, 1 7/8" Shackle Clearance, With Cylinder	5481F00 (P)	\$241.00			\$250.58	
	5481F00 (S)	\$228.00			\$237.58	
Indoor/Outdoor Padlock, Key Retaining, 1 7/8" Shackle Clearance, With Cylinder	5481FR0 (P)	\$241.00	\$174.60		\$250.58	
	5481FR0 (S)	\$228.00	\$167.70		\$237.58	
Indoor/Outdoor Padlock, Key Retaining, 1 3/8" Shackle Clearance, Less Cylinder	54815K0	\$82.00				
Indoor/Outdoor Padlock, Non-Key Retaining, 1 3/8" Shackle Clearance, Less Cylinder	54815L0	\$82.00				
Indoor/Outdoor Padlock, Key Retaining, 1 7/8" Shackle Clearance, Less Cylinder	5481FK0	\$87.00				
Indoor/Outdoor Padlock, Non-Key Retaining, 1 7/8" Shackle Clearance, Less Cylinder	5481FL0	\$87.00				

\*\*Refer to the eCylinder section for more detail on specific technologies available and pricing. Technologies are represented by the following letters:  
T = Medeco<sup>3</sup>, S = M<sup>3</sup> CLIQ, J = Medeco<sup>3</sup> BiLevel, W = Biaxial, V = Medeco Biaxial CLIQ, K = Medeco KM, N = Medeco X4, C = Classic CLIQ, M = Medeco X4 CLIQ,  
"-" = Original, Z = Medeco Original KW CLIQ, G = Medeco XT \*\*\*See key section for surcharges for custom coined cut keys or special stamping requirements.  
**Note:** (P) refers to **Pinned** and (S) to **Sub-Assembled** at the end of each part string in the price book.

**Indoor/Outdoor Padlock, 7/16" Shackle - 6 Pin SFIC**

Description	Part Number	M <sup>3</sup>	BiLevel	X4	Biax/Orig	KeyMark
Indoor/Outdoor Padlock, Non-Key Retaining, 1 3/8" Shackle Clearance, With Cylinder	5441500 (P)			\$157.90		\$164.24
	5441500 (S)			\$144.90		\$151.24
Indoor/Outdoor Padlock, Key Retaining, 1 3/8" Shackle Clearance, With Cylinder	54415R0 (P)			\$157.90		\$164.24
	54415R0 (S)			\$144.90		\$151.24
Indoor/Outdoor Padlock, Non-Key Retaining, 1 7/8" Shackle Clearance, With Cylinder	5441F00 (P)			\$162.90		\$169.24
	5441F00 (S)			\$149.90		\$156.45
Indoor/Outdoor Padlock, Key Retaining, 1 7/8" Shackle Clearance, With Cylinder	5441FR0 (P)			\$162.90		\$169.24
	5441FR0 (S)			\$149.90		\$156.45

**Indoor/Outdoor Padlock, 7/16" Shackle - 7 Pin SFIC**

Description	Part Number	M <sup>3</sup>	BiLevel	X4	Biax/Orig	KeyMark
Indoor/Outdoor Padlock, Non-Key Retaining, 1 3/8" Shackle Clearance With Cylinder	5443500 (P)			\$157.90		\$164.24
	5443500 (S)			\$144.90		\$151.24
Indoor/Outdoor Padlock, Key Retaining, 1 3/8" Shackle Clearance, With Cylinder	54435R0 (P)			\$157.90		\$164.24
	54435R0 (S)			\$144.90		\$151.24
Indoor/Outdoor Padlock, Non-Key Retaining, 1 7/8" Shackle Clearance, With Cylinder	5443F00 (P)			\$162.90		\$169.45
	5443F00 (S)			\$149.90		\$156.45
Indoor/Outdoor Padlock, Key Retaining, 1 7/8" Shackle Clearance, With Cylinder	5443FR0 (P)			\$162.90		\$169.45
	5443FR0 (S)			\$149.90		\$156.45

**Indoor/Outdoor Padlock, 7/16" Shackle - Less SFIC**

Description	Part Number	M <sup>3</sup>	BiLevel	X4	Biax/Orig	KeyMark
Indoor/Outdoor Padlock, Key Retaining, 1 3/8" Shackle Clearance, Less Cylinder	54415K0			\$79.00		
Indoor/Outdoor Padlock, Non-Key Retaining, 1 3/8" Shackle Clearance, Less Cylinder	54415L0			\$79.00		
Indoor/Outdoor Padlock, Key Retaining, 1 7/8" Shackle Clearance, Less Cylinder	5441FK0			\$84.00		
Indoor/Outdoor Padlock, Non-Key Retaining, 1 7/8" Shackle Clearance, Less Cylinder	5441FL0			\$84.00		

**Shrouded Padlock, 5/16" Shackle - KIK**

Description	Part Number	M <sup>3</sup>	BiLevel	X4	Biax/Orig	KeyMark
Shrouded Padlock, Non-Key Retaining, 3/4" Shackle Clearance, With Cylinder	5452500 (P)	\$171.00	\$124.50	\$157.90	\$177.64	\$164.24
	5452500 (S)	\$158.00	\$117.60	\$144.90	\$164.64	\$151.24
Shrouded Padlock, Key Retaining, 3/4" Shackle Clearance, With Cylinder	54525R0 (P)	\$171.00	\$124.50	\$157.90	\$177.64	\$164.24
	54525R0 (S)	\$158.00	\$117.60	\$144.90	\$164.64	\$151.24
Shrouded Padlock, Key Retaining, 3/4" Shackle Clearance, Less Cylinder	54525K0	\$69.60				
Shrouded Padlock, Non-Key Retaining, 3/4" Shackle Clearance, Less Cylinder	54525L0	\$69.60				

\*\*Refer to the eCylinder section for more detail on specific technologies available and pricing. Technologies are represented by the following letters:  
T = Medeco<sup>3</sup>, S = M<sup>3</sup> CLIQ, J = Medeco<sup>3</sup> BiLevel, W = Biaxial, V = Medeco Biaxial CLIQ, K = Medeco KM, N = Medeco X4, C = Classic CLIQ, M = Medeco X4 CLIQ,  
"." = Original, Z = Medeco Original KW CLIQ, G = Medeco XT \*\*\*See key section for surcharges for custom coined cut keys or special stamping requirements.  
**Note:** (P) refers to **Pinned** and (S) to **Sub-Assembled** at the end of each part string in the price book.

**Shrouded Padlock, 5/16" Shackle - 6 Pin LFIC**

Description	Part Number	M <sup>3</sup>	BiLevel	X4	Biax/Orig	KeyMark
Shrouded Padlock, Non-Key Retaining, 3/4" Shackle Clearance, With Cylinder	5462500 (P)	\$230.00			\$239.11	
	5462500 (S)	\$217.00			\$226.11	
Shrouded Padlock, Key Retaining, 3/4" Shackle Clearance, With Cylinder	54625R0 (P)	\$230.00			\$239.11	
	54625R0 (S)	\$217.00			\$226.11	
Shrouded Padlock, Key Retaining, 3/4" Shackle Clearance, Less Cylinder	54625K0	\$76.00				
Shrouded Padlock, Non-Key Retaining, 3/4" Shackle Clearance, Less Cylinder	54625L0	\$76.00				

**Shrouded Padlock, 5/16" Shackle - 6 Pin SFIC**

Description	Part Number	M <sup>3</sup>	BiLevel	X4	Biax/Orig	KeyMark
Shrouded Padlock, Non-Key Retaining, 3/4" Shackle Clearance, With Cylinder	5432500 (P)			\$152.90	\$159.03	
	5432500 (S)			\$139.90	\$146.03	
Shrouded Padlock, Key Retaining, 3/4" Shackle Clearance, With Cylinder	54325R0 (P)			\$152.90	\$159.03	
	54325R0 (S)			\$139.90	\$146.03	

**Shrouded Padlock, 5/16" Shackle - 7 Pin SFIC**

Description	Part Number	M <sup>3</sup>	BiLevel	X4	Biax/Orig	KeyMark
Shrouded Padlock, Non-Key Retaining, 3/4" Shackle Clearance, With Cylinder	5434500 (P)			\$152.90	\$159.03	
	5434500 (S)			\$139.90	\$146.03	
Shrouded Padlock, Key Retaining, 3/4" Shackle Clearance, With Cylinder	54345R0 (P)			\$152.90	\$159.03	
	54345R0 (S)			\$139.90	\$146.03	

**Shrouded Padlock, 5/16" Shackle - Less SFIC**

Description	Part Number	M <sup>3</sup>	BiLevel	X4	Biax/Orig	KeyMark
Shrouded Padlock, Key Retaining, 3/4" Shackle Clearance, Less Cylinder	54325K0			\$74.00		
Shrouded Padlock, Non-Key Retaining, 3/4" Shackle Clearance, Less Cylinder	54325L0			\$74.00		

\*\*Refer to the eCylinder section for more detail on specific technologies available and pricing. Technologies are represented by the following letters:  
T = Medeco<sup>3</sup>, S = M<sup>3</sup> CLIQ, J = Medeco<sup>3</sup> BiLevel, W = Biaxial, V = Medeco Biaxial CLIQ, K = Medeco KM, N = Medeco X4, C = Classic CLIQ, M = Medeco X4 CLIQ,  
“-” = Original, Z = Medeco Original KW CLIQ, G = Medeco XT \*\*\*See key section for surcharges for custom coined cut keys or special stamping requirements.  
**Note:** (P) refers to **Pinned** and (S) to **Sub-Assembled** at the end of each part string in the price book.



**Shrouded Padlock, 7/16" Shackle - KIK**

Description	Part Number	M <sup>3</sup>	BiLevel	X4	Biax/Orig	KeyMark
Shrouded Padlock, Non-Key Retaining, 3/4" Shackle Clearance, With Cylinder	5472500 (P)	\$208.00	\$161.50	\$194.90	\$216.19	\$202.79
	5472500 (S)	\$195.00	\$154.60	\$181.90	\$203.19	\$189.79
Shrouded Padlock, Key Retaining, 3/4" Shackle Clearance, With Cylinder	54725R0 (P)	\$208.00	\$161.50	\$194.90	\$216.19	\$202.79
	54725R0 (S)	\$195.00	\$154.60	\$181.90	\$203.19	\$189.79
Shrouded Padlock, Key Retaining, 3/4" Shackle Clearance, Less Cylinder	54725K0	\$106.60				
Shrouded Padlock, Non-Key Retaining, 3/4" Shackle Clearance, Less Cylinder	54725L0	\$106.60				

**Shrouded Padlock, 7/16" Shackle - 6 Pin LFIC**

Description	Part Number	M <sup>3</sup>	BiLevel	X4	Biax/Orig	KeyMark
Shrouded Padlock, Non-Key Retaining, 3/4" Shackle Clearance, With Cylinder	5482500 (P)	\$267.00			\$277.67	
	5482500 (S)	\$254.00			\$264.67	
Shrouded Padlock, Key Retaining, 3/4" Shackle Clearance, With Cylinder	54825R0 (P)	\$267.00			\$277.67	
	54825R0 (S)	\$254.00			\$264.67	
Shrouded Padlock, Key Retaining, 3/4" Shackle Clearance, Less Cylinder	54825K0	\$113.00				
Shrouded Padlock, Non-Key Retaining, 3/4" Shackle Clearance, Less Cylinder	54825L0	\$113.00				

**Shrouded Padlock, 7/16" Shackle - 6 Pin SFIC**

Description	Part Number	M <sup>3</sup>	BiLevel	X4	Biax/Orig	KeyMark
Shrouded Padlock, Non-Key Retaining, 3/4" Shackle Clearance, With Cylinder	5442500 (P)			\$186.90		\$194.45
	5442500 (S)			\$173.90		\$181.45
Shrouded Padlock, Key Retaining, 3/4" Shackle Clearance, With Cylinder	54425R0 (P)			\$186.90		\$194.45
	54425R0 (S)			\$173.90		\$181.45

**Shrouded Padlock, 7/16" Shackle - 6 Pin SFIC**

Description	Part Number	M <sup>3</sup>	BiLevel	X4	Biax/Orig	KeyMark
Shrouded Padlock, Non-Key Retaining, 3/4" Shackle Clearance, With Cylinder	5444500 (P)			\$186.90		\$194.45
	5444500 (S)			\$173.90		\$181.45
Shrouded Padlock, Key Retaining, 3/4" Shackle Clearance, With Cylinder	54445R0 (P)			\$186.90		\$194.45
	54445R0 (S)			\$173.90		\$181.45

**Shrouded Padlock, 7/16" Shackle - Less SFIC**

Description	Part Number	M <sup>3</sup>	BiLevel	X4	Biax/Orig	KeyMark
Shrouded Padlock, Key Retaining, 3/4" Shackle Clearance, Less Cylinder	54425K0	\$108.00				
Shrouded Padlock, Non-Key Retaining, 3/4" Shackle Clearance, Less Cylinder	54425L0	\$108.00				

\*\*Refer to the eCylinder section for more detail on specific technologies available and pricing. Technologies are represented by the following letters:  
T = Medeco<sup>3</sup>, S = M<sup>3</sup> CLIQ, J = Medeco<sup>3</sup> BiLevel, W = Biaxial, V = Medeco Biaxial CLIQ, K = Medeco KM, N = Medeco X4, C = Classic CLIQ, M = Medeco X4 CLIQ,  
“-” = Original, Z = Medeco Original KW CLIQ, G = Medeco XT \*\*\*See key section for surcharges for custom coined cut keys or special stamping requirements.  
**Note:** (P) refers to **Pinned** and (S) to **Sub-Assembled** at the end of each part string in the price book.

**52 Series Padlock, 5/16" Shackle**

Description	Part Number	M <sup>3</sup>	BiLevel	X4	Biax/Orig	KeyMark
1 1/8" Clearance, Boron Alloy Shackle	526201 (P)	\$149.00			\$154.71	
	526201 (S)	\$136.00			\$141.71	
2 3/8" Clearance, Boron Alloy Shackle	526301 (P)	\$149.00			\$154.71	
	526301 (S)	\$136.00			\$141.71	
1 1/8" Clearance, Boron Alloy Shackle, Less Cylinder	526200	\$88.60				
2 3/8" Clearance, Boron Alloy Shackle, Less Cylinder	526300	\$88.60				
1 1/8" Clearance, Stainless Steel Shackle	526211 (P)	\$149.00			\$154.71	
	526211 (S)	\$136.00			\$141.71	
2 3/8" Clearance, Stainless Steel Shackle	526311 (P)	\$149.00			\$154.71	
	526311 (S)	\$136.00			\$141.71	
1 1/8" Clearance, Stainless Steel Shackle, Less Cylinder	526210	\$88.60				
2 3/8" Clearance, Stainless Steel Shackle, Less Cylinder	526310	\$88.60				

\*Padlock body is solid brass with 26 plated finish.

**52 Series Padlock, 5/16" Shackle, Removable Core**

Description	Part Number	M <sup>3</sup>	BiLevel	X4	Biax/Orig	KeyMark
1 1/8" Clearance, Boron Alloy Shackle, Removable Core, Less Cylinder	52-6202	\$108.50				
2 3/8" Clearance, Boron Alloy Shackle, Removable Core, Less Cylinder	52-6302	\$108.50				
1 1/8" Clearance, Stainless Steel Shackle, Removable Core, Less Cylinder	52-6212	\$108.50				
2 3/8" Clearance, Stainless Steel Shackle, Removable Core, Less Cylinder	52-6312	\$108.50				

\*Padlock body is solid brass with 26 plated finish.

Note: 52-6 Series padlocks use a 5 pin/4 level 60 Series cylinder and can be keyed into a system utilizing cam and switch locks.

\*\*Refer to the eCylinder section for more detail on specific technologies available and pricing. Technologies are represented by the following letters:  
T = Medeco<sup>3</sup>, S = M<sup>3</sup> CLIQ, J = Medeco<sup>3</sup> BiLevel, W = Biaxial, V = Medeco Biaxial CLIQ, K = Medeco KM, N = Medeco X4, C = Classic CLIQ, M = Medeco X4 CLIQ,  
"." = Original, Z = Medeco Original KW CLIQ, G = Medeco XT \*\*\*See key section for surcharges for custom coined cut keys or special stamping requirements.  
**Note:** (P) refers to **Pinned** and (S) to **Sub-Assembled** at the end of each part string in the price book.

**52 Series Padlock, 7/16" Shackle**

Description	Part Number	M <sup>3</sup>	BiLevel	X4	Biax/Orig	KeyMark
1 3/8" Clearance, Boron Alloy Shackle	526001 (P)	\$149.00			\$154.71	
	526001 (S)	\$136.00			\$141.71	
1 7/8" Clearance, Boron Alloy Shackle	526101 (P)	\$149.00			\$154.71	
	526101 (S)	\$136.00			\$141.71	
1 3/8" Clearance, Boron Alloy Shackle, Less Cylinder	526000	\$88.60				
1 7/8" Clearance, Boron Alloy Shackle, Less Cylinder	526100	\$88.60				
1 3/8" Clearance, Stainless Steel Shackle	526011 (P)	\$149.00			\$154.71	
	526011 (S)	\$136.00			\$141.71	
1 7/8" Clearance, Stainless Steel Shackle	526111 (P)	\$149.00			\$154.71	
	526111 (S)	\$136.00			\$141.71	
1 3/8" Clearance, Stainless Steel Shackle, Less Cylinder	526010	\$88.60				
1 7/8" Clearance, Stainless Steel Shackle, Less Cylinder	526110	\$88.60				

\*Padlock body is solid brass with 26 plated finish.

**52 Series Padlock, 7/16" Shackle, Removable Core**

Description	Part Number	M <sup>3</sup>	BiLevel	X4	Biax/Orig	KeyMark
1 3/8" Clearance, Boron Alloy Shackle, Removable Core, Less Cylinder	526002	\$108.50				
1 7/8" Clearance, Boron Alloy Shackle, Removable Core, Less Cylinder	526102	\$108.50				
1 3/8" Clearance, Stainless Steel Shackle, Removable Core, Less Cylinder	526012	\$108.50				
1 7/8" Clearance, Stainless Steel Shackle, Removable Core, Less Cylinder	526112	\$108.50				

\*Padlock body is solid brass with 26 plated finish.

52 series Padlocks Cover Options: 00 = Standard, 01 = Case Cover, 10 = Dust Cover

Note: 52-6 Series padlocks use 5 pin/4 level 60 Series cylinders and can be keyed into a system utilizing cam and switch locks.

\*\*Refer to the eCylinder section for more detail on specific technologies available and pricing. Technologies are represented by the following letters:  
 T = Medeco<sup>3</sup>, S = M<sup>3</sup> CLIQ, J = Medeco<sup>3</sup> BiLevel, W = Biaxial, V = Medeco Biaxial CLIQ, K = Medeco KM, N = Medeco X4, C = Classic CLIQ, M = Medeco X4 CLIQ,  
 “. ” = Original, Z = Medeco Original KW CLIQ, G = Medeco XT \*\*\*See key section for surcharges for custom coined cut keys or special stamping requirements.  
**Note:** (P) refers to **Pinned** and (S) to **Sub-Assembled** at the end of each part string in the price book.

## 50 Series Brass Body Padlocks

Description	Part Number	M <sup>3</sup>	BiLevel	X4	Biax/Orig	KeyMark
I/C Core Brass Padlock, 2 1/4" Shackle Clearance, Hardened Steel, Key Retaining	5002201 (P)	\$301.00			\$313.10	
	5002201 (S)	\$288.00			\$300.10	
I/C Core Brass Padlock, 2 1/4" Shackle Clearance, Stainless Steel, Key Retaining	5002211 (P)	\$301.00			\$313.10	
	5002211 (S)	\$288.00			\$300.10	
I/C Core Brass Padlock, 2 1/4" Shackle Clearance, Hardened Steel, Non-key Retaining	5003201 (P)	\$301.00			\$313.10	
	5003201 (S)	\$288.00			\$300.10	
I/C Core Brass Padlock, 2 1/4" Shackle Clearance, Stainless Steel, Key Retaining	5003211 (P)	\$301.00			\$313.10	
	5003211 (S)	\$288.00			\$300.10	
Removeable Cylinder Brass Padlock, 2 1/4" Shackle Clearance, Hardened Steel, Key Retaining	5008201 (P)	\$283.00			\$294.34	
	5008201 (S)	\$270.00			\$281.34	
Removeable Cylinder Brass Padlock, 2 1/4" Shackle Clearance, Stainless Steel, Key Retaining	5008211 (P)	\$283.00			\$294.34	
	5008211 (S)	\$270.00			\$281.34	
Removeable Cylinder Brass Padlock, 2 1/4" Shackle Clearance, Hardened Steel, Non-key Retaining	5009201 (P)	\$283.00			\$294.34	
	5009201 (S)	\$270.00			\$281.34	
Removeable Cylinder Brass Padlock, 2 1/4" Shackle Clearance, Stainless Steel, Non-key Retaining	5009211 (P)	\$283.00			\$294.34	
	5009211 (S)	\$270.00			\$281.34	
Brass Padlock, 2 1/4" Shackle Clearance, Hardened Steel, Key Retaining, Less Cylinder	50-74201	\$143.00				
Brass Padlock, 2 1/4" Shackle Clearance, Stainless Steel, Key Retaining, Less Cylinder	50-74211	\$143.00				
Brass Padlock, 2 1/4" Shackle Clearance, Hardened Steel, Non-key Retaining, Less Cylinder	50-75201	\$143.00				
Brass Padlock, 2 1/4" Shackle Clearance, Stainless Steel, Non-key Retaining, Less Cylinder	50-75211	\$143.00				

## Padlock Cylinders

Description	Part Number	M <sup>3</sup>	BiLevel	X4	Biax/Orig	KeyMark
5 Pin Cylinder (6 pin Medeco X4) for Hockey Puck Style Padlock sold after 9/2004 (KIK style cylinder)	2001600 (P)	\$95.40	\$51.81	\$47.80	\$98.86	\$49.96
	2001600 (S)	\$82.40	\$44.91	\$34.80	\$85.86	\$36.96
6 Pin Cylinder for LFIC Medeco Padlocks, 50 & 54 Series	320201 (P)	\$144.00	\$78.30		\$149.50	
	320201 (S)	\$131.00	\$71.39		\$136.50	
Removeable Cylinder to fit 50 Series Brass Padlocks (Note - only available in 06 finish)	320202 (P)	\$127.00			\$131.79	
	320202 (S)	\$114.00			\$118.79	
6 Pin Cylinder for KIK Medeco Padlock, for 54 Series Padlocks	510600 (P)	\$101.40	\$55.26	\$88.30	\$105.11	\$91.71
	510600 (S)	\$88.40	\$48.36	\$75.30	\$92.11	\$78.71
5 Pin Spring Bolt Cylinder (non-key retaining), for G8R Padlock	960357 (P)	\$125.95			\$129.43	
	960357 (S)	\$82.90			\$86.38	
5 Pin Deadbolt Cylinder (key retaining), for G8R Padlock	960358 (P)	\$125.95			\$129.43	
	960358 (S)	\$82.90			\$86.38	
Spacer for use with 5 Pin Cylinders, for G8R Padlock	CP-160691	\$1.80				
5 Pin cylinder (cam lock style) for 52-6 padlocks	66418 (P)	\$110.15			\$112.97	
	66418 (S)	\$67.10			\$69.92	
5 Pin Removable plug for 52-6 padlocks	66391 (P)	\$100.25			\$102.65	
	66391 (S)	\$57.20			\$59.60	

eCylinder Padlock Cylinders are available for many of the padlocks. Please check the eCylinder section for specific part numbers and pricing.

\*\*Refer to the eCylinder section for more detail on specific technologies available and pricing. Technologies are represented by the following letters:  
T = Medeco<sup>3</sup>, S = M<sup>3</sup> CLIQ, J = Medeco<sup>3</sup> BiLevel, W = Biaxial, V = Medeco Biaxial CLIQ, K = Medeco KM, N = Medeco X4, C = Classic CLIQ, M = Medeco X4 CLIQ,  
"." = Original, Z = Medeco Original KW CLIQ, G = Medeco XT \*\*\*See key section for surcharges for custom coined cut keys or special stamping requirements.  
**Note:** (P) refers to **Pinned** and (S) to **Sub-Assembled** at the end of each part string in the price book.

### Components

Description	Part Number	Price
Component Package for 54 Series Padlocks, NonKey Retaining. Includes CP-130510 Cylinder Extension/Actuator, Spring & Washer, CP-022030 Cylinder Retainer, CP-011511-000 Retainer Screw, CP-250140 Steel Ball Bearing	94-0199	\$12.90
Cylinder Retainer Sleeve (Fits over Cylinder Bible Chamber & holds cylinder in padlock body)	CP-022030	\$6.60
Retainer Screw, #6-32 UNC-2A x .312" length	CP-011511-000	\$0.61
Cylinder Extension/Actuator, Non Key Retaining, Spring & Washer for 54 Series Padlocks	CP-130510	\$5.60
Stainless Steel Ball Bearing for 54 Series Padlocks, .360" Diameter	CP-250140	\$0.61
Cylinder Extension/Actuator, Key Retaining, for 54 Series Padlocks	CP-200720	\$5.60
Chain Assembly for 50 Series Brass Padlocks	CP-280271	\$29.70
Case Cover for 50 Series Brass Padlocks	CP-170250	\$17.80
Shackle Spring for 50 Series Brass Padlocks	CP-030430	\$0.39
Actuator Adaptor for 50 Series Brass Padlocks	CP-130101	\$7.60
Locking Balls for 50 Series Brass Padlocks	CP-250040	\$1.50
3/16" Cylinder Retaining Ball for 50 Series Brass Padlocks	CP-250030	\$0.37
1/16" Hex Allen Wrench - Long Arm to use with 50 Series Brass Padlocks	94-0020	\$4.90
Package for Sub-assembled 50 Series Brass Padlock, Includes: Set screws, retaining ball, Brass Pin Chamber Cover	94-0052	\$14.50

### Shackles for Indoor/Outdoor Padlocks

Description	Boron Alloy Steel		Stainless Steel	
	Part Number	Price	Part Number	Price
Standard Shackle for 54-51 Indoor/Outdoor Padlock, 1-1/8" Shackle Clearance x 5/16" Diameter	CP-144120	\$9.70	CP-144180	\$14.50
Extra Length Shackle for 54-51 Indoor/Outdoor Padlock, 2-3/8" Shackle Clearance x 5/16" Diameter	CP-144130	\$11.70	CP-144190	\$16.30
Standard Shackle for 54-71 Indoor/Outdoor Padlock, 1-3/8" Shackle Clearance x 7/16" Diameter	CP-144150	\$11.70	CP-144210	\$16.30
Extra Length Shackle for 54-71 Indoor/Outdoor Padlock, 1-7/8" Shackle Clearance x 7/16" Diameter	CP-144160	\$12.90	CP-144220	\$17.80

### Shackles for Shrouded Padlocks

Description	Boron Alloy Steel		Stainless Steel	
	Part Number	Price	Part Number	Price
Standard Shackle for 54-52 Shrouded Padlock, 3/4" Shackle Clearance x 5/16" Diameter	CP-144110	\$9.70	CP-144170	\$14.50
Standard Shackle for 54-72 Shrouded Padlock, 3/4" Shackle Clearance x 7/16" Diameter	CP-144140	\$11.70	CP-144200	\$16.30

### Shackles for 50 Series Brass Padlocks

Description	Part Number	Price
2 1/4" Stainless Steel Shackle for 50 Series Brass Padlocks	CP-142543	\$51.50
2 1/4" Hardened Steel Shackle for 50 Series Brass Padlocks	CP-142043	\$48.10

# Hockey Puck Padlocks

Medeco® offers a variety of high security padlocks that are designed to accept both mechanical and eCylinders. The Medeco Hockey Puck style padlocks come with hardened, solid steel bodies, a shackle-less design for the highest level of protection against bolt cutter attacks, and patent protected key control. Every padlock cylinder is UL 437 Listed and can be keyed into any existing 10 series product. The Medeco<sup>3</sup> unique design provides triple locking action, making the locks virtually pick proof. All Medeco<sup>3</sup> keys and locks are protected under patent, trademark, and copyright laws. Medeco<sup>3</sup> keys may only be duplicated by Medeco or by a Medeco authorized sales outlet, and only at your request.



### Patented Key Control

Protects against unauthorized duplication of your keys.



### Protection From Physical Attack

Medeco<sup>3</sup> padlock cylinders are UL 437 listed and stand up to drilling, picking and other forms of physical attack. The Hockey Pucks shackle-less design provides the highest protection from bolt cutter attacks.



### Can Be Master Keyed

Medeco Hockey Puck Padlocks can be master keyed into existing Medeco 10 Series products.



### Available in eCylinder

Medeco's Hockey Puck Padlocks are also available with Medeco eCylinders for Loss & Liability control.



### Special Angle Cut Keys

Requires a special key cutting machine and access to Medeco specific blanks, available in a variety of restrictions to support every need.



### Picking and Bumping Protection

Medeco<sup>3</sup> cylinders use a sidebar that prevent the key from rotating until it is elevated, rotated and aligned in the correct position. This feature protects against bumping and picking attacks.

### Technical Features:

- Hardened steel body.
- 5 pin, key-in-knob cylinder.
- Requires a key to relock.
- Hardened solid steel, black chrome plated body.
- All Medeco cylinders are constructed of durable machined brass components, designed to last the life of your equipment.

### Applications:

Hockey Puck style padlocks can be used in a variety of different applications including vending, storage and transportation.

### Warranty:

Warranted for two (2) years against manufacturer's defects. See the Medeco® limited warranty for full details.

### Available Key Technologies:

#### Mechanical:

- Medeco<sup>3</sup>
- Medeco<sup>3</sup> BiLevel\*
- Medeco X4\*

#### eCylinder:

- Medeco XT

## 52-9 Series Hockey Puck Padlock

Description	Part Number	Medeco <sup>3</sup>	BiLevel	Medeco X4
Hockey Puck Padlock, With 5 Pin High Security or 6 Pin Medeco X4 Cylinder	5293000 (P)	\$165.00	\$118.50	\$151.90
	5293000 (S)	\$152.00	\$111.60	\$138.90
Hockey Puck Padlock, Non-Key Retaining, Less Cylinder	52930L0	\$70.00		

Hockey Puck uses unique cylinders and can be pinned to a door hardware key. Not available with LFIC or SFIC.



# G8R Padlocks

Medeco® offers a variety of High Security Padlocks that are designed to accept both mechanical and eCylinders. With its tough, weather resistant construction, this is the padlock of choice for extreme environments such as trailers, cargo containers, and gates. The Medeco® G8R body is constructed of solid stainless steel. You can choose from either a stainless steel shackle for maximum corrosion resistance, or hardened steel to withstand severe physical attack. Each padlock includes a weather seal cap attached by a cable. The Medeco® G8R will accept either an eCylinder or mechanical t-handle cylinder. The mechanical cylinders provide the benefit of patented key control and pick resistance. The eCylinder adds sophisticated audit and control features transforming the G8R into a portable access control system for extreme environments.

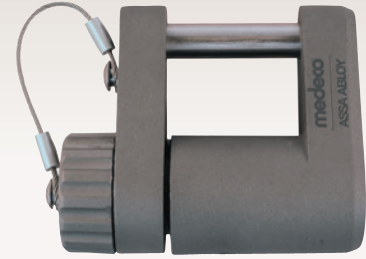

### Patented Key Control

Protects against unauthorized duplication of your keys.



### Protection From Physical Attack

Medeco<sup>3</sup> padlock cylinders are UL 437 listed and stand up to drilling, picking and other forms of physical attack. Available in either a hardened steel shackle to withstand severe physical attack or a stainless steel shackle for maximum corrosion resistance.



### Weather Resistant Construction

Uses a weather seal cap, attached by a cable, to provide protection from water and road grime.



### Available in eCylinder

Medeco G8R Padlocks are also available with Medeco eCylinders for Loss & Liability control.



### Special Angle Cut Keys

Requires a special key cutting machine and access to Medeco specific blanks, available in a variety of restrictions to support every need.



### Picking and Bumping Protection

Medeco<sup>3</sup> cylinders use a sidebar that prevent the key from rotating until it is elevated, rotated and aligned in the correct position. This feature protects against bumping and picking attacks.

### Technical Information:

- 300 series, cast stainless steel body.
- Padlock is sold less cylinder. Compatible with Medeco® mechanical and NEXGEN electronic t-handle cylinders.
- Padlocks are shipped with a weather seal cap attached by a steel cable. A finish plate is included for applications that do not require the weather seal cap.
- Sealed construction protects cylinders from water and road grime.
- Stainless steel body resists attack and corrosion.
- Shackles can be specified in stainless or hardened steel to fit your application.

### Applications:

- The G8R Series was designed for locking installations requiring weather resistance and strong physical security. Applications include: cargo containers, trailer doors, gates, vending machines.

### Warranty:

Warranted for two (2) years against manufacturer's defects. See the Medeco® limited warranty for full details

### Available Key Technologies:

#### Mechanical:

- Medeco<sup>3</sup>

#### eCylinder:

- Medeco XT
- Classic CLIQ
- Medeco Nexgen

## G8R Series Padlock

Description	Part Number	Price
G8R Weather-tight Padlock, 5/16" Stainless Steel Shackle, less pop-out cylinder	52110040	\$139.00
G8R Weather-tight Padlock, 5/16" Hardened Steel Shackle, less pop-out cylinder	52111040	\$139.00
G8R Weather-tight Padlock, 7/16" Stainless Steel Shackle, less pop-out cylinder	52120040	\$139.00
G8R Weather-tight Padlock, 7/16" Hardened Steel Shackle, less pop-out cylinder	52121040	\$139.00
G8R cap and seal kit	94-0213	\$25.20

G8R padlocks are sold less cylinder and use a cam lock style key with pop-out plug.

Keys are charged separately for this style cylinder.



# Cam, Cabinet & Switch Locks

FEATURES	Medeco <sup>3</sup>	CLIQ	Medeco XT
Easily integrated into existing cam lock master key systems	●	●	●
Easy installation	●	●	●
Completely serviceable and may be rekeyed in the event of a lost or stolen key	●	●	●
UL437 Listing on cylinder for high security	●		
Cam locks available in all standard lengths, flats, and rotations	●	●	●
Switch locks available in single or double switch models and momentary and maintained positions with silver or gold contacts (for low amperage applications) designed to accept quick connect leads	●	●	●

## Medeco<sup>3</sup> Premium High Security

For effective mechanical protection against most forms of attack as well as protection against unauthorized duplicate keys, Medeco<sup>3</sup> cylinders are recommended. Security features including hardened steel components, pins that must be elevated, rotated, and interact with both a sidebar and a slider, and additional pick resistant features make Medeco<sup>3</sup> the cylinder of choice to protect people, property and information.

## Intelligent Key Solutions

Many of the cylinders in this section are also available with an Intelligent Key solution. See the Intelligent Key section for more details.

# Cam Locks

## Cam Lock Installation Instructions & Op Codes

### Medeco Cam Lock Part Number Configurations

Model Number	Operation Code	Cylinder	Finish	Keyway	"Cam Lock Operation Code" – Describes the function of the lock: direction of key turn, rotation, key retaining or two key-pull.
XXXXXXXX	XXX	X	26	XX	

### Cam Lock Operation Codes – Fixed Core Cam Locks

*Describes the function of the lock*

Operation Code	Rotation Distance	Direction to Unlock	Key Retaining or 2 Key Pull
219	90°	Clockwise	Key Retaining
229	90°	Clockwise	2 Key Pull
239	90°	Counterclockwise	Key Retaining
249	90°	Counterclockwise	2 Key Pull
259	180°	Clockwise	Key Retaining
269	180°	Clockwise	2 Key Pull
279	180°	Counterclockwise	Key Retaining
289	180°	Counterclockwise	2 Key Pull

**Note:** Key Retaining – Key is removable in the locked position only.

2 Key Pull – Key is removable in both the locked and unlocked positions.

# Cam Locks

Medeco® High Security Cam Locks are recognized throughout the world as the standard for protection in a 3/4 inch diameter lock. Medeco Cam Locks utilize hardened, stainless steel inserts throughout the cylinder to provide the ultimate defense against drilling, pulling, and other forms of vandal attacks. Patented key control programs prevent the unauthorized duplication of keys and maintain system integrity. Keyed alike, keyed different, or master keyed, Medeco offers a complete line of cam locks in a wide variety of sizes and functions to meet your specific needs.



### Patented Key Control

Protects against unauthorized duplication of your keys.



### Available in eCylinder

Medeco cam locks are also available with Medeco eCylinders for loss & liability control.



### Can Be Master Keyed

Medeco cam locks can be keyed alike, keyed different or master keyed.



### Protection From Physical Attack

Medeco3 cam locks are UL 437 Listed and stand up to drilling, picking and other forms of physical attack.

## Benefits:

- All Medeco® cylinders are constructed of durable machined brass components.
- Hardened stainless steel inserts inside the cylinder provide the ultimate defense against drilling and other forms of physical attack.
- Unique elevating and rotating tumbler pin system is virtually pick proof.
- Patented Medeco<sup>3</sup> keys may only be duplicated by Medeco or an authorized Medeco service outlet, and only at your request.
- Locks can be keyed alike, keyed different, or master keyed depending on your specific needs.
- Available in various lengths and rotations.

## Technical Information:

- Four or five pin models available depending on size
- Available in three standard sizes, 1 1/16 inch, 7/8 inch and 1 1/8 inch
- Two flat models available, key retaining only
- Clockwise or counterclockwise rotation, 90 or 180 degrees
- Keyed alike, keyed different or master keyed

## Warranty:

Warranted for two (2) years against manufacturer's defects. See the Medeco® limited warranty for full details

## Finishes:

- 26 satin chrome finish standard
- Other finishes available, depending on volume

## Certification:

- UL437 Listed

## Applications:

Medeco® Cam Locks can be used in any standard 3/4 inch diameter application and a multitude of markets including:

- Safes
- Communication
- Alarm
- Access control
- Banking
- Utility
- Data Encryption
- Cabinet
- Transit
- Lockers

## Available Key Technologies:

### Mechanical:

- Medeco<sup>3</sup>

### eCylinder:

- Classic CLIQ
- Medeco XT

**Medeco<sup>3</sup> All-In-One Cam Lock Kits**

Description	Part Number	M <sup>3</sup>	BiLevel	X4	Biax/Orig	KeyMark
7/8" Length 5 Pin Cam Lock Kit	600350T KIT (P)	\$90.75			\$93.96	
	600350T KIT (S)	\$84.50			\$87.71	
11/8" Length 5 Pin Cam Lock Kit	600650T KIT (P)	\$90.75			\$93.96	
	600650T KIT (S)	\$84.50			\$87.71	
5/8" Length 5 Pin Cam Lock Kit	601150T KIT (P)	\$90.75			\$93.96	
	601150T KIT (S)	\$84.50			\$87.71	
11/2" 5 Pin Cam Lock Kit	601450T KIT (P)	\$94.55			\$97.92	
	601450T KIT (S)	\$88.30			\$91.67	

**Medeco X4 Cam Lock Kit**

Description	Part Number	M <sup>3</sup>	BiLevel	X4	Biax/Orig	KeyMark
1 1/8" length Medeco X4 7 pin cam lock kit with two cams, hex nut, lock washer, mounting washer and 1/4" spacer collar.	210503 (P)			\$86.40		\$89.48
	210503 (S)			\$73.40		\$76.48

There is a 6 piece minimum order quantity for high security cam locks.

All-in-One Cam Lock Kits include: CP-040500 pronged washer, CT-A05 flat cam, CT-D05 flat cam, CT-J01 offset cam, CT-H07 offset cam, CP-040451 90 degree stop washer, CP-040461 180 degree stop washer CP-050060 3/4" - 27 mounting nut and 2 keys.

Master keying is not available in a cam lock kit, but may be custom ordered with specific cam locks listed on the following pages.

\*\*Refer to the eCylinder section for more detail on specific technologies available and pricing. Technologies are represented by the following letters:  
T = Medeco<sup>3</sup>, S = M<sup>3</sup> CLIQ, J = Medeco<sup>3</sup> BiLevel, W = Biaxial, V = Medeco Biaxial CLIQ, K = Medeco KM, N = Medeco X4, C = Classic CLIQ, M = Medeco X4 CLIQ,  
"." = Original, Z = Medeco Original KW CLIQ, G = Medeco XT \*\*\*See key section for surcharges for custom coined cut keys or special stamping requirements.  
**Note:** (P) refers to **Pinned** and (S) to **Sub-Assembled** at the end of each part string in the price book.

## High Security Cam Locks

Description	Part Number	M <sup>3</sup>	BiLevel	X4	Biax/Orig	KeyMark
5 pin, 1 1/16" Cam lock	600250T (P)	\$119.45			\$122.66	
	600250T (S)	\$76.40			\$79.61	
5 pin, 7/8" Cam lock	600350T (P)	\$119.45			\$122.66	
	600350T (S)	\$76.40			\$79.61	
5 pin, 1" Cam lock	600450T (P)	\$119.45			\$122.66	
	600450T (S)	\$76.40			\$79.61	
4 pin, 7/8" Cam lock	600550T (P)	\$117.65			\$120.78	
	600550T (S)	\$74.60			\$77.73	
5 pin, 1 1/8" Cam lock	600650T (P)	\$119.45			\$122.66	
	600650T (S)	\$76.40			\$79.61	
4 pin, 1 1/16" Cam lock	600750T (P)	\$117.65			\$120.78	
	600750T (S)	\$74.60			\$77.73	
4 pin, 5/8" Cam lock	600850T (P)	\$117.65			\$120.78	
	600850T (S)	\$74.60			\$77.73	
5 pin, 3/4" Cam lock	600950T (P)	\$119.45			\$122.66	
	600950T (S)	\$76.40			\$79.61	
5 pin, 5/8" Cam lock	601150T (P)	\$119.45			\$122.66	
	601150T (S)	\$76.40			\$79.61	
3 pin, 7/16" Cam lock	601250T (P)	\$109.35			\$112.13	
	601250T (S)	\$66.30			\$69.08	
3 pin, 5/8" Cam lock	601251T (P)	\$109.35			\$112.13	
	601251T (S)	\$66.30			\$69.08	
5 pin, 1 1/2" Cam lock	601450T (P)	\$123.25			\$126.62	
	601450T (S)	\$80.20			\$83.57	
5 pin, 2" Cam lock	601452T (P)	\$126.45			\$129.95	
	601452T (S)	\$83.40			\$86.90	

You must specify the operation code to complete the part number. Pinned pricing includes two keys. Standard sizes described, contact Medeco customer service or [medeco.com](http://medeco.com) for variations not listed.

There is a 6 piece minimum order quantity for high security cam locks.

## Cam Lock Operation Codes

Description	Part Number
2 flat, 1 Keypull, Clockwise 90 degree	219
2 Flat, 2 Keypull, Clockwise 90 degree	229
2 Flat, 1 Keypull, Counterclockwise 90 degree	239
2 Flat, 2 Keypull, Counterclockwise 90 degree	249
2 Flat, 1 Keypull, Clockwise 180 degree	259
2 Flat, 2 Keypull, Clockwise 180 degree	269
2 Flat, 1 Keypull, Counterclockwise 180 degree	279
2 Flat, 2 Keypull, Counterclockwise 180 degree	289

\*\*Refer to the eCylinder section for more detail on specific technologies available and pricing. Technologies are represented by the following letters:  
T = Medeco<sup>3</sup>, S = M<sup>3</sup> CLIQ, J = Medeco<sup>3</sup> BiLevel, W = Biaxial, V = Medeco Biaxial CLIQ, K = Medeco KM, N = Medeco X4, C = Classic CLIQ, M = Medeco X4 CLIQ,  
"-" = Original, Z = Medeco Original KW CLIQ, G = Medeco XT \*\*\*See key section for surcharges for custom coined cut keys or special stamping requirements.

**Note:** (P) refers to **Pinned** and (S) to **Sub-Assembled** at the end of each part string in the price book.

# Removable Core Cam Locks

Medeco® cam locks are available with a removable core feature allowing cores to be changed out in seconds, to provide an entirely new keying combination. For applications that may require instantaneous re-keying due to lost or stolen keys, or where periodic re-keying is done as a matter of good business practice, Medeco removable core cam locks save valuable time and money. Removable core cam locks offer the same high security features of a Medeco cam lock with the convenience of a removable core.

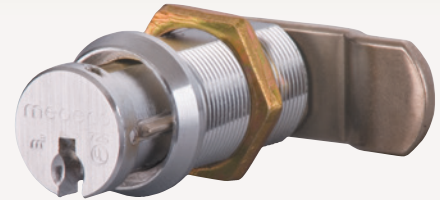

### Patented Key Control

Protects against unauthorized duplication of your keys.



### Quickly Change Cores

Medeco removable provide quick and easy cylinder changes in the event keys are lost or stolen.



### Protection From Physical Attack

Medeco<sup>3</sup> cam locks are UL 437 Listed and stand up to drilling, picking and other forms of physical attack.

## Benefits:

- Removable cores can be changed out in seconds to provide a new, secure keying combination.
- All Medeco cylinders are constructed of durable machined brass components.
- Hardened stainless steel inserts inside the cylinder provide the ultimate defense against drilling and other forms of physical attack.
- Unique elevating and rotating tumbler pin system is virtually pick proof.
- Patented Medeco<sup>3</sup> keys may only be duplicated by Medeco or an authorized Medeco service outlet, and only at your request.
- Locks can be keyed alike, keyed different, or master keyed depending on your specific needs.
- Available in various lengths and rotations.

## Technical Information:

- Four or five pin models available depending on size
- Available in three standard sizes, 11/16 inch, 7/8 inch and 1 1/8 inch
- Two flat models available, key retaining only
- Clockwise or counterclockwise rotation, 90 or 180 degrees
- Keyed alike, keyed different or master keyed

## Warranty:

Warranted for two (2) years against manufacturer's defects. See the Medeco® limited warranty for full details

## Finishes:

- 26 satin chrome finish standard
- Other finishes available, depending on volume

## Applications:

- Medeco® Removable Core Cam Locks can be used in any standard 3/4 inch diameter application and a multitude of markets including:
  - Safes
  - Utility
  - Communications
  - Data Encryption
  - Alarms
  - Cabinets
  - Access control
  - Transit
  - Banking
  - Lockers

## Available Key Technologies:

### Mechanical:

– Medeco<sup>3</sup>

## High Security Removable Core Cam Locks

Description	Part Number	M <sup>3</sup>	BiLevel	X4	Biax/Orig	KeyMark
4 pin, 1 1/16" Removable core camlock	607155XT (P)	\$133.75			\$137.56	
	607155XT (S)	\$90.70			\$94.51	
4 pin, 7/8" Removable core camlock	607255XT (P)	\$133.75			\$137.56	
	607255XT (S)	\$90.70			\$94.51	
4 pin, 1 1/8" Removable core camlock	607355XT (P)	\$133.75			\$137.56	
	607355XT (S)	\$90.70			\$94.51	
5 pin, 1 1/8" Removable core camlock	607455XT (P)	\$135.45			\$139.33	
	607455XT (S)	\$92.40			\$96.28	
5 pin, 7/8" Removable core camlock	607555XT (P)	\$135.45			\$139.33	
	607555XT (S)	\$92.40			\$96.28	
Plug for Removable Core Cam Locks. Cam locks are provided with plug, but additional plugs may be ordered separately. Keys not included in price.	66391 (P)	\$100.25			\$102.65	
	66391 (S)	\$57.20			\$59.60	

Pinned price includes 2 keys.

## X = Rotation for Removable Core Cam Lock

Description	Part Number
90 degree Clockwise	0
90 degree Counterclockwise	1
180 degree Clockwise	2
180 degree Counterclockwise	3

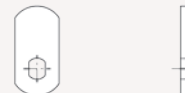

## A Series Flat Cams

Description	Part Number	Price
5/8" Flat Cam	CT-A00	\$2.60
3/4" Flat Cam	CT-A01	\$2.60
7/8" Flat Cam	CT-A02	\$2.60
1" Flat Cam	CT-A03	\$2.60
1 1/8" Flat Cam	CT-A04	\$2.60
1 1/4" Flat Cam	CT-A05	\$2.60
1 3/8" Flat Cam	CT-A06	\$2.60
1 1/2" Flat Cam	CT-A07	\$2.60
1 5/8" Flat Cam	CT-A08	\$2.60
1 3/4" Flat Cam	CT-A09	\$2.60
2" Flat Cam	CT-A11	\$2.60
2 1/8" Flat Cam	CT-A12	\$2.60
2 1/4" Flat Cam	CT-A13	\$2.60
2 3/8" Flat Cam	CT-A14	\$2.60
2 1/2" Flat Cam	CT-A15	\$2.60
2 5/8" Flat Cam	CT-A16	\$2.60
3" Flat Cam	CT-A19	\$2.60

\*\*Refer to the eCylinder section for more detail on specific technologies available and pricing. Technologies are represented by the following letters:  
 T = Medeco<sup>3</sup>, S = M<sup>3</sup> CLIQ, J = Medeco<sup>3</sup> BiLevel, W = Biaxial, V = Medeco Biaxial CLIQ, K = Medeco KM, N = Medeco X4, C = Classic CLIQ, M = Medeco X4 CLIQ,  
 ". = Original, Z = Medeco Original KW CLIQ, G = Medeco XT \*\*\*See key section for surcharges for custom coined cut keys or special stamping requirements.  
**Note:** (P) refers to Pinned and (S) to Sub-Assembled at the end of each part string in the price book.



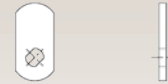

### C Series Flat Cams, 45° Tenon

Description	Part Number	Price
7/8" Flat Cam	CT-C02	\$2.60
1 1/8" Flat Cam	CT-C04	\$2.60
1 1/4" Flat Cam	CT-C05	\$2.60
1 5/8" Flat Cam	CT-C08	\$2.60
1 3/4" Flat Cam	CT-C09	\$2.60
2" Flat Cam	CT-C11	\$2.60

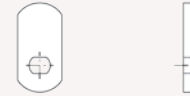

### D Series Flat Cams, Horizontal Tenon

Description	Part Number	Price
5/8" Flat Cam	CT-D00	\$2.60
3/4" Flat Cam	CT-D01	\$2.60
7/8" Flat Cam	CT-D02	\$2.60
1" Flat Cam	CT-D03	\$2.60
1 1/8" Flat Cam	CT-D04	\$2.60
1 1/4" Flat Cam	CT-D05	\$2.60
1 3/8" Flat Cam	CT-D06	\$2.60
1 1/2" Flat Cam	CT-D07	\$2.60
1 5/8" Flat Cam	CT-D08	\$2.60
1 3/4" Flat Cam	CT-D09	\$2.60
2" Flat Cam	CT-D11	\$2.60
2 1/8" Flat Cam	CT-D12	\$2.60
2 1/2" Flat Cam	CT-D15	\$2.60
3" Flat Cam	CT-D19	\$2.60



### H Series Offset Cam, Vertical Tenon

Description	Part Number	Price
1 1/4" Cam with 1/8" offset	CT-H00	\$2.70
1 1/8" Cam with 7/32" offset	CT-H07	\$2.70
1 1/8" Cam with 1/8" offset	CT-H09	\$2.70
1 1/2" Cam with 7/32" offset	CT-H14	\$2.70
1 1/4" Cam with 7/32" offset	CT-H15	\$2.70
1 1/8" Cam with 5/16" offset	CT-H16	\$2.70
1 1/4" Cam with 5/16" offset	CT-H17	\$2.70
1 3/4" Cam with 5/16" offset	CT-H19	\$2.70
2" Cam with 5/16" offset	CT-H20	\$2.70
7/8" Cam with 5/32" offset	CT-H27	\$2.70
1 3/4" Cam with 7/32" offset	CT-H30	\$2.70
1 1/2" Cam with 5/16" offset	CT-H32	\$2.70

\*\*Refer to the eCylinder section for more detail on specific technologies available and pricing. Technologies are represented by the following letters:  
 T = Medeco<sup>3</sup>, S = M<sup>3</sup> CLIQ, J = Medeco<sup>3</sup> BiLevel, W = Biaxial, V = Medeco Biaxial CLIQ, K = Medeco KM, N = Medeco X4, C = Classic CLIQ, M = Medeco X4 CLIQ,  
 “. ” = Original, Z = Medeco Original KW CLIQ, G = Medeco XT \*\*\*See key section for surcharges for custom coined cut keys or special stamping requirements.

**Note:** (P) refers to **Pinned** and (S) to **Sub-Assembled** at the end of each part string in the price book.



### J Series Offset Cam, Horizontal

Description	Part Number	Price
1 1/8" Cam with 7/32" offset	CT-J01	\$2.70
1" Cam with 1/8" offset	CT-J05	\$2.70
1 1/4" Cam with 1/8" offset	CT-J07	\$2.70
1 5/8" Cam with 1/8" offset	CT-J08	\$2.70
2 1/8" Cam with 1/8" offset	CT-J11	\$2.70
1 1/4" Cam with 7/32" offset	CT-J12	\$2.70
1 1/8" Cam with 5/16" offset	CT-J13	\$2.70
1 1/4" Cam with 5/16" offset	CT-J14	\$2.70
1 5/8" Cam with 5/16" offset	CT-J15	\$2.70
2 1/8" Cam with 5/16" offset	CT-J18	\$2.70
1 1/8" Cam with 5/32" offset	CT-J22	\$2.70
1 1/2" Cam with 5/16" offset	CT-J27	\$2.70
2 1/8" Cam with 7/32" offset	CT-J28	\$2.70
7/8" Cam with 5/32" offset	CT-J29	\$2.70

### 3/4" Removable Plug Lock

Description	Part Number	M <sup>3</sup>	BiLevel	X4	Biax/Orig	KeyMark
1 keypull, 3/4" Removable plug lock	640250T (P)	\$123.75			\$127.14	
	640250T (S)	\$80.70			\$84.09	
2 keypull, 3/4" Removable plug lock	640251T (P)	\$123.75			\$127.14	
	640251T (S)	\$80.70			\$84.09	

### 1 1/8" Removable Plug Lock

Description	Part Number	M <sup>3</sup>	BiLevel	X4	Biax/Orig	KeyMark
1 keypull, vertical flats, flush mount	640550T (P)	\$137.55			\$141.52	
	640550T (S)	\$94.50			\$98.47	
1 keypull, horizontal flats, flush mount	640550AT (P)	\$137.55			\$141.52	
	640550AT (S)	\$94.50			\$98.47	
2 keypull, vertical flats, surface mount with tapered bezel	640550FT (P)	\$137.55			\$141.52	
	640550FT (S)	\$94.50			\$98.47	

*Pinned price includes 2 keys.*

\*\*Refer to the eCylinder section for more detail on specific technologies available and pricing. Technologies are represented by the following letters:  
 T = Medeco<sup>3</sup>, S = M<sup>3</sup> CLIQ, J = Medeco<sup>3</sup> BiLevel, W = Biaxial, V = Medeco Biaxial CLIQ, K = Medeco KM, N = Medeco X4, C = Classic CLIQ, M = Medeco X4 CLIQ,  
 “. ” = Original, Z = Medeco Original KW CLIQ, G = Medeco XT \*\*\*See key section for surcharges for custom coined cut keys or special stamping requirements.  
**Note:** (P) refers to **Pinned** and (S) to **Sub-Assembled** at the end of each part string in the price book.

### Security Collars

Description	Part Number	Price
Cam lock security collar	CP-070501	\$8.70
Cam lock security collar	CP-070131	\$8.70
Cam lock security collar	CP-070161	\$8.70
Cam lock security collar	CP-070171	\$8.70
Cam lock security collar	CP-070441	\$8.70
Cam lock security collar	CP-070201	\$8.70
Cam lock security collar	CP-070111	\$8.70
Cam lock security collar	CP-070141	\$8.70
Cam lock security collar	CP-070181	\$8.70
Cam lock security collar	CP-070481	\$8.70

### Security Collars

Part Number	(H)	(I)	(J)	(K)	(L)
CP-070501	1.000"	.142"	.170"	.312"	1.290"
CP-070131	.885"	.142"	.170"	.312"	1.210"
CP-070161	.885"	.188"	.250"	.438"	1.356"
CP-070171	.885"	.200"	.238"	.438"	1.290"
CP-070441	.885"	.260"	.070"	.330"	1.210"
CP-070201	.885"	.262"	.050"	.312"	1.210"
CP-070111	.885"	.278"	.160"	.438"	1.290"
CP-070141	.885"	.325"	.050"	.375"	1.275"
CP-070181	1.000"	.450"	.050"	.500"	1.250"
CP-070481	1.000"	.638"	.050"	.688"	1.313"

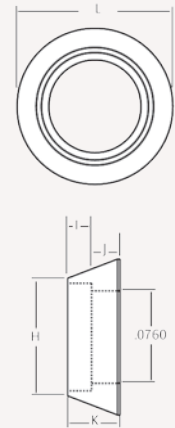

### Spacers

Description	Part Number	Price
Cam lock spacer, obtain specific part number from following dimension chart.	CP-160XXX	\$7.40

### Spacers

Part Number	(M)	(N)
CP-160051	.125"	.875"
CP-160101	.140"	.875"
CP-160071	.188"	.875"
CP-160111	.200"	.875"
CP-160081	.250"	.875"
CP-160091	.275"	.875"
CP-160301	.375"	.875"
CP-160121	.400"	.875"
CP-160061	.530"	.875"
CP-160271	.437"	.875"
CP-160541	.031"	.875"
CP-160551	.062"	.875"
CP-160571	.312"	.875"
CP-160591	.062"	.995"
CP-160601	.125"	.995"
CP-160611	.250"	.995"

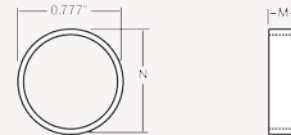

\*\*Refer to the eCylinder section for more detail on specific technologies available and pricing. Technologies are represented by the following letters: T = Medeco<sup>3</sup>, S = M<sup>3</sup> CLIQ, J = Medeco<sup>3</sup> BiLevel, W = Biaxial, V = Medeco Biaxial CLIQ, K = Medeco KM, N = Medeco X4, C = Classic CLIQ, M = Medeco X4 CLIQ, " " = Original, Z = Medeco Original KW CLIQ, G = Medeco XT \*\*\*See key section for surcharges for custom coined cut keys or special stamping requirements.  
**Note:** (P) refers to Pinned and (S) to Sub-Assembled at the end of each part string in the price book.

## Pop-Out, T-Handle Cylinder

Description	Part Number	M <sup>3</sup>	BiLevel	X4	Biax/Orig	KeyMark
5 pin, zinc deadbolt	640155CT (P)	\$109.95			\$112.76	
	640155CT (S)	\$66.90			\$69.71	
5 pin, zinc springbolt	640155T (P)	\$109.95			\$112.76	
	640155T (S)	\$66.90			\$69.71	
4 pin, zinc springbolt	640750ET (P)	\$111.65			\$114.53	
	640750ET (S)	\$68.60			\$71.48	
4 pin, zinc deadbolt	640750GT (P)	\$111.65			\$114.53	
	640750GT (S)	\$68.60			\$71.48	
4 pin, steel springbolt	640950T (P)	\$118.75			\$121.93	
	640950T (S)	\$75.70			\$78.88	
4 pin, steel deadbolt	640952T (P)	\$118.75			\$121.93	
	640952T (S)	\$75.70			\$78.88	
4 pin, steel springbolt, steel shell	641050T (P)	\$147.05			\$151.42	
	641050T (S)	\$104.00			\$108.37	
4 pin, steel deadbolt, steel shell	641051T (P)	\$147.05			\$151.42	
	641051T (S)	\$104.00			\$108.37	

*Pinned price includes two keys.*

\*\*Refer to the eCylinder section for more detail on specific technologies available and pricing. Technologies are represented by the following letters:  
T = Medeco<sup>3</sup>, S = M<sup>3</sup> CLIQ, J = Medeco<sup>3</sup> BiLevel, W = Biaxial, V = Medeco Biaxial CLIQ, K = Medeco KM, N = Medeco X4, C = Classic CLIQ, M = Medeco X4 CLIQ,  
“-” = Original, Z = Medeco Original KW CLIQ, G = Medeco XT \*\*\*See key section for surcharges for custom coined cut keys or special stamping requirements.  
**Note:** (P) refers to **Pinned** and (S) to **Sub-Assembled** at the end of each part string in the price book.

# Cabinet Locks

Medeco® cabinet locks are specifically designed for drawer or cabinet door applications where a conventional utility cam lock may not be suitable. Cabinet locks utilize heavy-duty bolts and multi-point attachment to the mounting surface in order to withstand the heavy use and higher physical security some applications may require. All Medeco cabinet locks feature solid brass and steel construction, available in either fixed or removable core. Patented key programs prevent the unauthorized duplication of keys and maintain system integrity. Keyed alike, keyed different, or master keyed, the Medeco cabinet lock is the perfect solution for your showcase security needs.



### Patented Key Control

Protects against unauthorized duplication of your keys.



### Available in eCylinder

Medeco cabinet locks are also available with Medeco eCylinders for loss & liability control.



### Protection From Physical Attack

Medeco<sup>3</sup> cabinet locks are UL 437 Listed and stand up to drilling, picking and other forms of physical attack.

## Benefits:

- Medeco high security cabinet locks are constructed of durable machined brass and solid steel components.
- Available in either fixed or removable core depending on your specific requirements.
- Available in either deadbolt or spring latch models.
- Unique elevating and rotating tumbler pin system is virtually pick proof.
- Patented Medeco<sup>3</sup> keys may only be duplicated by Medeco or an authorized Medeco service outlet, and only at your request.
- Medeco Cabinet Locks can be keyed in with other 60 Series products.
- Locks can be keyed alike, keyed different, or master keyed depending on your specific needs.

## Technical Information:

- Five pin models available in either deadbolt or spring latch versions.
- 7/8 inch diameter, surface mount, fixed or removable core available.
- Deadbolt fixed core available in non-key retaining.
- Keyed alike, keyed different, or master keyed.

## Warranty:

Warranted for two (2) years against manufacturer's defects. See the Medeco® limited warranty for full details.

## Finishes:

- 26 satin chrome finish standard.
- Other finishes available, depending on volume.

## Applications:

- Medeco cabinet locks are specifically designed for use in metal or wooden drawer and cabinet door applications including:
  - Medical and narcotics
  - Chests and cabinets
  - Showcases
  - Cash carts
  - Drawers

## Available Key Technologies:

### Mechanical:

– Medeco<sup>3</sup>

### eCylinder:

– Medeco XT

### High Security Cabinet Locks

Description	Part Number	M <sup>3</sup>	BiLevel	X4	Biax/Orig	KeyMark
Cabinet lock with deadbolt, single keypull	6210555T (P)	\$153.05				
	6210555T (S)	\$110.00				
Cabinet lock with deadbolt, double keypull	6212555T (P)	\$153.05				
	6212555T (S)	\$110.00				
Cabinet lock with spring bolt, single keypull	6211555T (P)	\$166.05				
	6211555T (S)	\$123.00				
Removable core cabinet lock with deadbolt, single keypull, less plug	6270515	\$73.50				
Removable core cabinet lock with spring bolt, single keypull, less plug	6271515	\$81.80				
Plug for removable plug cabinet lock	66391 (P)	\$100.25				
	66391 (S)	\$57.20				

*Pinned price includes two keys.*

### SFIC Cabinet Locks

Description	Part Number	Price
Cabinet lock with deadbolt for SFIC cylinder. Works with Medeco X4, Medeco XT SFIC, or Best style SFIC. SFIC ordered separately.	3307311	\$61.40
Cabinet lock with spring latch for SFIC cylinder. Works with Medeco X4, Medeco XT SFIC, or Best style SFIC. SFIC ordered separately.	3307321	\$61.40
File Cabinet Lock for SFIC cylinder. Works with Medeco X4, Medeco XT SFIC or Best style SFIC Cylinders . SFIC ordered separately.	3307350	\$61.40
Door/Drawer Lock for SFIC cylinder. Works with Medeco X4, Medeco XT SFIC, or best style SFIC. SFIC ordered separately.	3307331	\$61.40

\*\*Refer to the eCylinder section for more detail on specific technologies available and pricing. Technologies are represented by the following letters:  
 T = Medeco<sup>3</sup>, S = M<sup>3</sup> CLIQ, J = Medeco<sup>3</sup> BiLevel, W = Biaxial, V = Medeco Biaxial CLIQ, K = Medeco KM, N = Medeco X4, C = Classic CLIQ, M = Medeco X4 CLIQ,  
 “. ” = Original, Z = Medeco Original KW CLIQ, G = Medeco XT \*\*\*See key section for surcharges for custom coined cut keys or special stamping requirements.

**Note:** (P) refers to **Pinned** and (S) to **Sub-Assembled** at the end of each part string in the price book.

# Plunger Locks

Medeco® plunger locks are specifically designed for use in wooden or metal sliding doors. Complete with a spring loaded pop out cylinder, the Medeco plunger lock is ideal for security merchandise showcases, metal cabinets, and laboratory and office furniture. Plunger locks require no key when locking the device; simply push in on the cylinder to relock. Patented key programs prevent the unauthorized duplication of keys and maintain system integrity. Keyed alike, keyed different, or master keyed, the Medeco plunger lock is the perfect solution for your security needs.



### Patented Key Control

Protects against unauthorized duplication of your keys.



### Can Be Master Keyed

Medeco plunger locks can be keyed alike, keyed different or master keyed.



### Protection From Physical Attack

Medeco<sup>3</sup> plunger locks are UL 437 Listed and stand up to drilling, picking and other forms of physical attack.

### Benefits:

- Medeco plunger locks are constructed of durable machined brass and solid steel components
- Unique elevating and rotating tumbler pin system is virtually pick proof
- Patented Medeco<sup>3</sup> keys may only be duplicated by Medeco or an authorized Medeco service outlet, and only at your request
- Medeco plunger locks are completely serviceable, and can be re-keyed in case of lost or stolen keys
- Locks can be keyed alike, keyed different, or master keyed depending on your specific needs

### Technical Information:

- Four and five pin models available
- Non-key retaining cylinders
- 45 degree clockwise rotation to unlock
- Keyed alike, keyed different or master keyed

### Warranty:

Warranted for two (2) years against manufacturer's defects. See the Medeco limited warranty for full details.

### Finishes:

- 26 satin chrome finish standard.
- Other finishes available, depending on volume.

### Applications:

- Medeco Plunger Locks are specifically designed for use in metal or wooden sliding door applications including:
  - Jewelry and other merchandise showcases
  - Metal cabinets
  - Laboratory furniture
  - Office furniture

### Available Key Technologies:

- |                       |                   |
|-----------------------|-------------------|
| <b>Mechanical:</b>    | <b>eCylinder:</b> |
| – Medeco <sup>3</sup> | – Classic CLIQ    |

### Plunger Locks

Description	Part Number	M <sup>3</sup>	BiLevel	X4	Biax/Orig	KeyMark
Plunger lock, 5 pin round bolt	6221557T(P)	\$165.05			\$170.17	
	6221557T(S)	\$122.00			\$127.12	
Plunger lock, 5 pin glass mount	6261557T(P)	\$191.05			\$197.27	
	6261557T(S)	\$148.00			\$154.22	
Plunger lock, 4 pin round bolt	6221554T(P)	\$165.05			\$170.17	
	6221554T(S)	\$122.00			\$127.12	

Pinned price includes two keys.



# Micro Switch Locks

Medeco's 3/4" diameter, high security switch locks offer a wide range of electrical functions with the physical security and patented key control of a Medeco cylinder. Available in either single or double switch models, Medeco switch locks are ideally suited for applications requiring controlled access to electrically activated systems, including alarms, ATMs, time delay safes, encryption devices, heavy power equipment, control panels and electrically accessed doors and gates. The Medeco<sup>3</sup> unique design provides triple locking action, making the locks virtually pick proof. All Medeco<sup>3</sup> keys and locks are protected under patent, trademark and copyright laws. Medeco keys may only be duplicated by Medeco or by an authorized Medeco dealer, and only at your request.

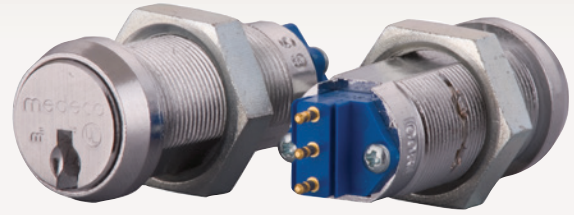

### Patented Key Control

Protects against unauthorized duplication of your keys.



### Can Be Master Keyed

Medeco switch locks can be keyed alike, keyed different or master keyed.



### Protection From Physical Attack

Medeco<sup>3</sup> switch locks are UL 437 Listed and stand up to drilling, picking and other forms of physical attack.

## Benefits:

- All Medeco cylinders are constructed of durable machined brass components, designed to last the life of your equipment.
- Available in single or double switch models, momentary and maintained positions.
- Silver or gold contacts (for low amperage applications) designed to accept quick connect leads.
- Hardened stainless steel inserts inside the cylinder provide the ultimate defense against drilling and other forms of physical attack.
- Unique elevating and rotating tumbler pin system is virtually pick proof.
- Patented Medeco<sup>3</sup> keys may only be duplicated by Medeco or an authorized Medeco service outlet, and only at your request.
- Medeco Switch Locks are completely serviceable, and can be re-keyed in case of lost or stolen keys.
- Locks can be keyed alike, keyed different, or master keyed depending on your specific needs.

## Certification:

- UL 437 Listed
- Switch - UL Registered, CSA Certified

## Applications:

- Medeco High Security Switch Locks can be used in any standard 3/4 inch diameter switch lock application and a multitude of markets including:
  - Heavy Power Machinery
  - Time Delay Safes
  - Material Handling Equipment
  - Construction Vehicles
  - Electrically Accessed Gates
  - Cash Control Systems
  - Encryption Devices
  - Alarms
  - Control Panels
  - ATMs

## Warranty:

Warranted for two (2) years against manufacturer's defects. See the Medeco<sup>®</sup> limited warranty for full details.

## Technical Information:

- Five pin, 3/4 inch double "D" mounting standard.
- Available in either single or double switch models with either silver or gold contacts.
- Rated at 7 amps resistive at 125/250 VAC.
- Contacts designed to accept quick connect leads (AMP connector number 60598-3)

## Finishes:

- 26 satin chrome finish standard.
- Other finishes available, depending on volume.

## Available Key Technologies:

### Mechanical:

- Medeco<sup>3</sup>

**Single Switch Locks**

Description	Part Number	M <sup>3</sup>	BiLevel	X4	Biax/Orig	KeyMark
1 switch, Maintained 1 Keypull	652150T 011 (P)	\$144.05			\$148.29	
	652150T 011 (S)	\$101.00			\$105.24	
1 switch, Maintained 2 Keypull	652150T 012 (P)	\$144.05			\$148.29	
	652150T 012 (S)	\$101.00			\$105.24	
1 switch, Momentary 1 Keypull	652150T 021 (P)	\$144.05			\$148.29	
	652150T 021 (S)	\$101.00			\$105.24	

*Pinned price includes two keys.*

**Double Switch Locks**

Description	Part Number	M <sup>3</sup>	BiLevel	X4	Biax/Orig	KeyMark
2 position, maintained, 1 keypull	652650T 101 (P)	\$220.05			\$227.48	
	652650T 101 (S)	\$177.00			\$184.43	
2 position, maintained, 2 keypull	652650T 102 (P)	\$220.05			\$227.48	
	652650T 102 (S)	\$177.00			\$184.43	
2 position, momentary, 1 keypull	652650T 111 (P)	\$220.05			\$227.48	
	652650T 111 (S)	\$177.00			\$184.43	
3 position, maintained, 1 keypull	652650T 131 (P)	\$220.05			\$227.48	
	652650T 131 (S)	\$177.00			\$184.43	
3 position, maintained, 2 keypull	652650T 132 (P)	\$220.05			\$227.48	
	652650T 132 (S)	\$177.00			\$184.43	
3 position, maintained, 3 keypull	652650T 133 (P)	\$220.05			\$227.48	
	652650T 133 (S)	\$177.00			\$184.43	

*Pinned price includes two keys.*

**Switch Lock Accessories for 652150 and 652650**

Description	Part Number	Price
Silver Sub Miniature Snap Action Switch. Double Pole/Double Throw	CP-150082	\$54.30
Gold Sub Miniature Snap Action Switch. Double Pole/Double Throw	CP-150102	\$72.20
Sleeve Kit. Includes chrome plated zinc sleeve with rubber grommet, plain washer, 1 pronged washer locks for mounting cam locks in harsh environments.	650003	\$40.70
Silver Sub Miniature Snap Action Switch. Single Pole-Single or Double Throw	CP-150142	\$27.40
Gold Sub Miniature Snap Action Switch. Single Pole-Single or Double Throw	CP-150152	\$39.10
4" Leadwire	CP-270511	\$1.90
6" Leadwire	CP-270521	\$2.20
12" Leadwire	CP-270531	\$2.80
18" Leadwire	CP-270541	\$3.50
24" Leadwire	CP-270551	\$7.50
36" Leadwire	CP-270561	\$7.50

\*\*Refer to the eCylinder section for more detail on specific technologies available and pricing. Technologies are represented by the following letters:  
 T = Medeco<sup>3</sup>, S = M<sup>3</sup> CLIQ, J = Medeco<sup>3</sup> BiLevel, W = Biaxial, V = Medeco Biaxial CLIQ, K = Medeco KM, N = Medeco X4, C = Classic CLIQ, M = Medeco X4 CLIQ,  
 ". = Original, Z = Medeco Original KW CLIQ, G = Medeco XT \*\*\*See key section for surcharges for custom coined cut keys or special stamping requirements.

**Note:** (P) refers to **Pinned** and (S) to **Sub-Assembled** at the end of each part string in the price book.

# Rotary Switch Locks

The Medeco® rotary switch lock is designed for use with most brands of rotary switches, providing maximum versatility in systems requiring multiple switch functions. Switch locks are available with a variety of key withdrawals at 45° increments. Positive stops are available to eliminate over-torquing of switch stops. Switch locks use a five pin cylinder to maximize keyed different and master keying capabilities. Medeco design and engineering resources are available to assist customers with special functional requirements. The Medeco<sup>3</sup> unique design provides triple locking action, making the locks virtually pick proof. All Medeco<sup>3</sup> keys and locks are protected under patent, trademark and copyright laws. Medeco<sup>3</sup> keys may only be duplicated by Medeco or by an authorized Medeco dealer, and only at your request.



### Patented Key Control

Protects against unauthorized duplication of your keys.



### Available in eCylinder

Medeco cabinet locks are also available with Medeco eCylinders for loss & liability control.



### Can Be Master Keyed

Medeco switch locks can be keyed alike, keyed different or master keyed.



### Protection From Physical Attack

Medeco<sup>3</sup> switch locks stand up to drilling, picking and other forms of physical attack.

## Benefits:

- All Medeco cylinders are constructed of durable machined brass components, designed to last the life of your equipment.
- Hardened stainless steel inserts inside the cylinder provide the ultimate defense against drilling and other forms of physical attack.
- Unique elevating and rotating tumbler pin system is virtually pick proof.
- Patented Medeco<sup>3</sup> keys may only be duplicated by Medeco or an authorized Medeco service outlet, and only at your request.
- Medeco switch locks are completely serviceable, and can be re-keyed in case of lost or stolen keys.
- Locks can be keyed alike, keyed different, or master keyed depending on your specific needs.

## Warranty:

Warranted for two (2) years against manufacturer's defects. See the Medeco limited warranty for full details.

## Technical Information:

- Five pin, 3/4 inch double "D" mounting standard.

## Finishes:

- 26 satin chrome finish standard.
- Other finishes available, depending on volume.

## Certification:

- Switch - UL Registered, CSA Certified

## Applications:

- Medeco Rotary Switch Locks can be used to retrofit many switch lock applications including:
  - Heavy Power Machinery
  - Time Delay Safes
  - Material Handline Equipment
  - Construction Vehicles
  - Electrically Accessed Gates
  - Cash Control Systems
  - Encryption Devices
  - Alarms
  - Control Panels
  - ATMs

## Available Key Technologies:

### Mechanical:

– Medeco<sup>3</sup>

### eCylinder:

– Medeco XT

**Double Switch Rotary**

Description	Part Number	M <sup>3</sup>	BiLevel	X4	Biax/Orig	KeyMark
2 position, 1 keypull A, maintained at B	6522560T 121 (P)	\$140.95			\$145.06	
	6522560T 121 (S)	\$97.90			\$102.01	
2 position, 2 keypull A&B, maintained	6522560T 122 (P)	\$140.95			\$145.06	
	6522560T 122 (S)	\$97.90			\$102.01	
3 position, 2 keypull A&B, maintained	6522560T 132 (P)	\$140.95			\$145.06	
	6522560T 132 (S)	\$97.90			\$102.01	
3 position, 3 keypull A, B&C, maintained	6522560T 133 (P)	\$140.95			\$145.06	
	6522560T 133 (S)	\$97.90			\$102.01	
3 position, 2 keypull A&C, maintained at B	6522560T 134 (P)	\$140.95			\$145.06	
	6522560T 134 (S)	\$97.90			\$102.01	
2 position, 1 keypull A, momentary at B	6522560T 221 (P)	\$140.95			\$145.06	
	6522560T 221 (S)	\$97.90			\$102.01	

*Pinned price includes two keys.*

\*\*Refer to the eCylinder section for more detail on specific technologies available and pricing. Technologies are represented by the following letters:  
T = Medeco<sup>3</sup>, S = M<sup>3</sup> CLIQ, J = Medeco<sup>3</sup> BiLevel, W = Biaxial, V = Medeco Biaxial CLIQ, K = Medeco KM, N = Medeco X4, C = Classic CLIQ, M = Medeco X4 CLIQ,  
“-” = Original, Z = Medeco Original KW CLIQ, G = Medeco XT \*\*\*See key section for surcharges for custom coined cut keys or special stamping requirements.  
**Note:** (P) refers to **Pinned** and (S) to **Sub-Assembled** at the end of each part string in the price book.

## Keying Charges

Description	Part Number	Price
Less Key Credit		-\$1.00
MK surcharge to pinned door hardware cylinders and IC cylinders except SFIC cylinders.		\$19.70
No MK surcharge is applied to the pinned cylinder price for Medeco X4 SFIC cylinders.		
MK surcharge to pinned cam lock type product (less keys)		\$4.15
Key Stamping (Standard Key Code Stamping at No Charge)		\$2.50
Lock Stamping (No charge for SFIC)		\$6.60
Surcharge - Medeco X4 Custom Coined Cut keys require a minimum of 100 keys and must be specified on the order. Non-custom coined cut keys are standard from the factory. The surcharge is added to the cut key price.		\$2.50
Surcharge - High Security Custom Coined Cut keys require a minimum of 100 keys and must be specified on the order. Non-custom coined cut keys are standard from the factory. The surcharge is added to the cut key price.		\$2.50
Sub-assembled deduct applied for door products		\$13.00
Sub-assembled deduct applied for Medeco X4 SFIC		\$13.00
Sub-assembled deduct applied for 60 Series products		\$43.05
Non-Masterkeyed cylinders (less keys)	RE-KEY	\$48.90
Masterkeyed Cylinders (5 and 6 pin, less keys)	RE-KEY-MK	\$58.70
Decode Key Service	DE-CODE-KEY	\$30.40
Decode Lock Service (not available for padlocks)	DE-CODE-LOK	\$30.90
Sharpen Cutter for Medeco <sup>3</sup> and Medeco X4 (exchange program; old cutter must be returned upon receipt with RGA)	KM-SHARP-CUT	\$193.00

## Cut Keys

Description	Part Number	Price
High Security Cut Keys for Cam Style Locks and for Door Hardware (Specify Keyway)	KYC 346600 XX XX	\$18.40
Medeco X4 Cut Keys (Specify Keyway)	KYC 326900 XXX XX	\$16.20
High Security Custom Coined Cut Keys (Minimum order 100)	KYC 355600 XX 99	\$20.90
Medeco X4 Custom Coined Cut Keys (Minimum order 100)	KYC 326900 XXX 99	\$18.70
Medeco <sup>B</sup> Cut Keys, A5 Bow (Specify Key way)	KYC A50000 AXX 00	\$11.70
Medeco <sup>B</sup> Cut Keys, A6 Bow (Specify Key way)	KYC A60000 AXX 00	\$13.30

Contact Customer Service for specific part number.

## Coining Dies

Description	Part Number	Price
Standard Coining Die-All keyway technologies	CN-DIES	\$527.00 (NET)
Laser Die	ST-LASER	\$127.00 (NET)

\*\*Refer to the eCylinder section for more detail on specific technologies available and pricing. Technologies are represented by the following letters:  
T = Medeco<sup>3</sup>, S = M<sup>3</sup> CLIQ, J = Medeco<sup>3</sup> BiLevel, W = Biaxial, V = Medeco Biaxial CLIQ, K = Medeco KM, N = Medeco X4, C = Classic CLIQ, M = Medeco X4 CLIQ,  
“.” = Original, Z = Medeco Original KW CLIQ, G = Medeco XT \*\*\*See key section for surcharges for custom coined cut keys or special stamping requirements.  
**Note:** (P) refers to **Pinned** and (S) to **Sub-Assembled** at the end of each part string in the price book.

## Key Code Cards

Description	Part Number	Price
Authorization Card for 6 Pin Key (Patriot, Liberty, Freedom, Gotham)	CARD 1 X XX	\$11.90
Authorization Card for 5 Pin Key (Patriot, Liberty, Freedom, Gotham)	CARD 2 X XX	\$11.90
Authorization Card for 5 Pin (60Series) Key (Patriot, Liberty, Freedom, Gotham)	CARD 6 X XX	\$11.90
Authorization Card with (2) 6 Pin Keys (Medeco KM Silver)	CARD KS XX 8E	\$36.80
Authorization Card with (2) 5 Pin Keys (Patriot, Liberty, GLD, DND, Freedom, Gotham)	CARD XX 56 XX	\$36.80
Authorization Card with (2) 6 Pin Keys (Patriot, Liberty, GLD, DND, Freedom, Gotham)	CARD XX 66 XX	\$36.80
Printed Key Code Tag For Dealer Keyways	CP-286131	\$1.00

## Code Books, Vouchers, & Paper

Description	Part Number	Price
Medeco <sup>3</sup> Code Book	CB-CODE-BIA	\$42.40 (NET)
Medeco Original Code Book	CB-CODE-BOK	\$42.40 (NET)
Patriot/Liberty/Freedom/Gotham USB card reader	94-0309	\$67.00 (NET)

## Sales Tools

Description	Part Number	Price
Smart SFIC Solutions Demo Kit (Includes Arrow, Medeco X4, and Medeco XT SFIC Cylinders)	94-0261	\$1,304.00
Medeco <sup>3</sup> Display Kit Includes Captive T-Turn Deadbolt Cut-away Cylinder, Cam Lock	94-0204	\$203.00 (NET)
Medeco X4 Presentation Kit includes: Std. Rim & Mortise Cylinders, SFIC Mortise, Key-In-Knob Cylinder, all LFIC cylinders in plastic case	94-0269	\$279.00 (NET)
6 Pin Medeco <sup>3</sup> BiLevel Cut-Away Cylinder	10400 CUT J	\$99.81 (NET)
6 Pin Medeco <sup>3</sup> Cut-Away Cylinder	10400 CUT T	\$168.70 (NET)
Cut-Away 5 Pin Profile Cylinder	23130 CUT	\$166.00 (NET)
Cut-Away Cam Lock Assembly – Biaxial only	600300 CUT W 219	\$96.39 (NET)
Plastic Display Sleeve for Maxum (lock not included)	90-0028	\$18.00 (NET)
XT Install/Demo Key (works cylinders not yet programmed to a system) – Industrial Style	EA-100111	\$212.00
XT Install/Demo Control Key (works IC cylinders not yet programmed to a system) – Industrial Style	EA-100110	\$212.00
XT Install/Demo Key – Slim Line (works cylinders not yet programmed to a system)	EA-100173	\$204.00
XT Install/Demo Control Key – Slim Line (works IC Cylinders not yet programmed to a system)	EA-100174	\$204.00

\*\*Refer to the eCylinder section for more detail on specific technologies available and pricing. Technologies are represented by the following letters:  
T = Medeco<sup>3</sup>, S = M<sup>3</sup> CLIQ, J = Medeco<sup>3</sup> BiLevel, W = Biaxial, V = Medeco Biaxial CLIQ, K = Medeco KM, N = Medeco X4, C = Classic CLIQ, M = Medeco X4 CLIQ,  
“.” = Original, Z = Medeco Original KW CLIQ, G = Medeco XT \*\*\*See key section for surcharges for custom coined cut keys or special stamping requirements.

**Note:** (P) refers to **Pinned** and (S) to **Sub-Assembled** at the end of each part string in the price book.

**Keyblanks for Cam Lock Style - Original, Medeco Biaxial, Medeco<sup>3</sup>**

Description	Part Number	Price
5 Pin Commercial Original Keyblank for 60 Series, Thick Head (Non Custom Coined)	KYB 115400 XX 00	\$8.90
5 Pin Commercial Original Keyblank for 60 Series, Thin Head (Non Custom Coined)	KYB 105400 XX 00	\$8.90
5 Pin Commercial Medeco Biaxial Keyblank for 60 Series, Thick Head (Non Custom Coined)	KYB 115400 S6 43	\$8.90
5 Pin Keyblank for 60 Series (Custom Coined)	KYB XX5400 XX 99	\$8.90

**Keyblanks for Door Hardware - Original, Medeco Biaxial, Medeco<sup>3</sup>**

Description	Part Number	Price
5 or 6 Pin Keyblank Round Bow (Non Custom Coined)	KYB 10X600 XX XX	\$8.90
5 or 6 Pin Keyblank for Medeco <sup>3</sup> (Small Bow, Custom Coined)	KYB 34X600 XX 99	\$8.60
5 or 6 Pin Keyblank for Medeco <sup>3</sup> (Large Bow, Custom Coined)	KYB 33X600 XX 99	\$8.60
5 or 6 Pin Keyblank for Medeco Biaxial Rectangular (Small Bow, Custom Coined)	KYB 12X600 XX 99	\$8.60
5 or 6 Pin Keyblank for Medeco Biaxial, Square (Large Bow, Custom Coined)	KYB 17X600 XX 99	\$8.60
5 or 6 Pin Keyblank for Thumbturn (blade only)	KYB 10X605 XX	\$11.20

**Keyblanks for Door Hardware - Medeco KM, Medeco X4 & Medeco<sup>B</sup>**

Description	Part Number	Price
6 or 7 Pin Keyblank for Medeco KM (Small Bow, Custom Coined)	KYB 32X600 XX 99	\$8.10
6 or 7 Pin Keyblank for Medeco KM (Large Bow, Custom Coined)	KYB 38X600 XX 99	\$8.10
6 or 7 Pin Keyblank for Medeco X4 (Small Bow, Custom Coined)	KYB 32X900 XX 99	\$8.10
6 or 7 Pin Keyblank for Medeco X4 (Large Bow, Custom Coined)	KYB 38X900 XX 99	\$8.10
6 or 7 Pin Keyblank for Medeco <sup>B</sup> , Alphabet & T Keyways	KYB A50000-AXX00	\$2.20
6 or 7 Pin Keyblank for Medeco <sup>B</sup> , W Family Keyway	KYB A60000-AXX00	\$3.80

\*\*Refer to the eCylinder section for more detail on specific technologies available and pricing. Technologies are represented by the following letters:  
T = Medeco<sup>3</sup>, S = M<sup>3</sup> CLIQ, J = Medeco<sup>3</sup> BiLevel, W = Biaxial, V = Medeco Biaxial CLIQ, K = Medeco KM, N = Medeco X4, C = Classic CLIQ, M = Medeco X4 CLIQ,  
“-” = Original, Z = Medeco Original KW CLIQ, G = Medeco XT \*\*\*See key section for surcharges for custom coined cut keys or special stamping requirements.  
**Note: (P)** refers to **Pinned** and **(S)** to **Sub-Assembled** at the end of each part string in the price book.



## Keys with Hybrid Heads – 125 kHz Proximity

Description	Part Number	Price
Original/Biaxial heads only	EA-300069-01-EL	\$17.30
Medeco <sup>3</sup> /Medeco X4, Medeco KM Heads only	EA-300070-01-EL	\$17.30
Medeco X4, Medeco KM/Medeco <sup>3</sup> dimpled blade	KYB 77663F NM XX	\$25.20
Original/Biaxial dimpled blade	KYB 74563F NM XX	\$25.20
5 pin Medeco <sup>3</sup> key blank	KYB 35563P XX 99	\$25.20
6 pin Medeco <sup>3</sup> key blank	KYB 35663P XX 99	\$25.20
5 pin Original/Biaxial key blank	KYB 74563P XX 99	\$25.20
6 pin Original/Biaxial key blank	KYB 74663P XX 99	\$25.20
6 pin Medeco KM key blank	KYB 77663P XX 99	\$24.70
7 pin Medeco KM key blank	KYB 77763P XX 99	\$24.70
6 pin Medeco X4 key blank	KYB 77693P XXX 99	\$24.70
7 pin Medeco X4 key blank	KYB 77793P XXX 99	\$24.70
5 pin Medeco <sup>3</sup> cut key	KYC 35563P XX 99	\$37.50
6 pin Medeco <sup>3</sup> cut key	KYC 35663P XX 99	\$37.50
5 pin Original/Biaxial cut key	KYC 74563P XX 99	\$37.50
6 pin Original/Biaxial cut key	KYC 74663P XX 99	\$37.50
6 pin Medeco KM cut key	KYC 77663P XX 99	\$35.30
7 pin Medeco KM cut key	KYC 77763P XX 99	\$35.30
6 pin Medeco X4 cut key	KYC 77693P XXX 99	\$35.30
7 pin Medeco X4 cut key	KYC 77793P XXX 99	\$35.30

Stamping is required on all restricted keyblanks .

Please see the eCylinder section for eCylinder key information.

\*\*Refer to the eCylinder section for more detail on specific technologies available and pricing. Technologies are represented by the following letters:  
T = Medeco<sup>3</sup>, S = M<sup>3</sup> CLIQ, J = Medeco<sup>3</sup> BiLevel, W = Biaxial, V = Medeco Biaxial CLIQ, K = Medeco KM, N = Medeco X4, C = Classic CLIQ, M = Medeco X4 CLIQ,  
"." = Original, Z = Medeco Original KW CLIQ, G = Medeco XT \*\*\*See key section for surcharges for custom coined cut keys or special stamping requirements.  
**Note:** (P) refers to **Pinned** and (S) to **Sub-Assembled** at the end of each part string in the price book.

### Keys with Hybrid 2k Bit Heads – 13.56 MHz iCLASS

Description	Part Number	Price
Original/Biaxial heads only	EA-300086-01-EL	\$21.70
Medeco <sup>3</sup> /Medeco X4 Heads only	EA-300087-01-EL	\$21.70
Original/Biaxial dimpled blade	KYB 74563H NM XX	\$28.70
Medeco X4/Medeco <sup>3</sup> dimpled blade	KYB 77663H NM XX	\$28.70
5 pin Medeco <sup>3</sup> key blank	KYB 35563K XX 99	\$28.70
6 pin Medeco <sup>3</sup> key blank	KYB 35663K XX 99	\$28.70
5 pin Original/Biaxial key blank	KYB 74563K XX 99	\$28.70
6 pin Original/Biaxial key blank	KYB 74663K XX 99	\$28.70
5 pin Medeco <sup>3</sup> cut key	KYC 35563K XX 99	\$41.00
6 pin Medeco <sup>3</sup> cut key	KYC 35663K XX 99	\$41.00
5 pin Original/Biaxial cut key	KYC 74563K XX 99	\$41.00
6 pin Original/Biaxial cut key	KYC 74663K XX 99	\$41.00
6 pin Medeco X4 cut key	KYC 77693K XXX 99	\$38.80
7 pin Medeco X4 cut key	KYC 77793K XXX 99	\$38.80

Stamping is required on all restricted keyblanks.

### Keys with Hybrid 16k Bit Heads – 13.56 MHz iCLASS

Description	Part Number	Price
Original/Biaxial heads only	EA-300088-01-EL	\$30.40
Medeco <sup>3</sup> /Medeco X4 heads only	EA-300089-01-EL	\$30.40
Original/Biaxial dimpled blade	KYB 74563N NM XX	\$37.00
Medeco X4/Medeco <sup>3</sup> dimpled blade	KYB 77663N NM XX	\$37.00
5 pin Medeco <sup>3</sup> key blank	KYB 35563J XX 99	\$37.00
6 pin Medeco <sup>3</sup> key blank	KYB 35663J XX 99	\$49.30
5 pin Original/Biaxial key blank	KYB 74563J XX 99	\$49.30
6 pin Original/Biaxial key blank	KYB 74663J XX 99	\$37.00
5 pin Medeco <sup>3</sup> cut key	KYC 35563J XX 99	\$49.30
6 pin Medeco <sup>3</sup> cut key	KYC 35663J XX 99	\$49.30
5 pin Original/Biaxial cut key	KYC 74563J XX 99	\$49.30
6 pin Original/Biaxial cut key	KYC 74663J XX 99	\$49.30
6 pin Medeco X4 cut key	KYC 77693J XXX 99	\$47.10
7 pin Medeco X4 cut key	KYC 77793J XXX 99	\$47.10

Stamping is required on all restricted keyblanks.

### Hybrid Dummy heads only

Description	Part Number	Price
Original/Biaxial (25 pack)	CP-286531-25-EL	\$54.90
Medeco X4/Medeco <sup>3</sup> (25 pack)	CP-286541-25-EL	\$54.90

\*\*Refer to the eCylinder section for more detail on specific technologies available and pricing. Technologies are represented by the following letters:  
 T = Medeco<sup>3</sup>, S = M<sup>3</sup> CLIQ, J = Medeco<sup>3</sup> BiLevel, W = Biaxial, V = Medeco Biaxial CLIQ, K = Medeco KM, N = Medeco X4, C = Classic CLIQ, M = Medeco X4 CLIQ,  
 “. ” = Original, Z = Medeco Original KW CLIQ, G = Medeco XT \*\*\*See key section for surcharges for custom coined cut keys or special stamping requirements.  
**Note:** (P) refers to **Pinned** and (S) to **Sub-Assembled** at the end of each part string in the price book.

### Hybrid Dummy heads with key blanks

Description	Part Number	Price
5 pin Medeco <sup>3</sup>	KYB 355640 XX 99	\$9.80
6 pin Medeco <sup>3</sup>	KYB 356640 XX 99	\$9.80
5 pin Original/Biaxial	KYB 745640 XX 99	\$9.80
6 pin Original/Biaxial	KYB 746640 XX 99	\$9.80
6 pin Medeco KM	KYB 776640 XX 99	\$9.30
7 pin Medeco KM	KYB 777640 XX 99	\$9.30
6 pin Medeco X4 key blank	KYB 776940 XXX 99	\$9.30
7 pin Medeco X4 key blank	KYB 777940 XXX 99	\$9.30

Stamping is required on all restricted key blanks.

### Hybrid Dummy heads with cut keys

Description	Part Number	Price
5 pin Medeco <sup>3</sup>	KYC 355640 XX 99	\$22.10
6 pin Medeco <sup>3</sup>	KYC 356640 XX 99	\$20.90
5 pin Original/Biaxial	KYC 745640 XX 99	\$22.10
6 pin Original/Biaxial	KYC 746640 XX 99	\$22.10
6 pin Medeco KM	KYC 776640 XX 99	\$19.90
7 pin Medeco KM	KYC 777640 XX 99	\$19.90
6 pin Medeco X4 cut key	KYC 776940 XXX 99	\$19.90
7 pin Medeco X4 cut key	KYC 777940 XXX 99	\$19.90

### Hybrid Blades only, no heads, key blanks

Description	Part Number	Price
5 pin Medeco <sup>3</sup>	KYB 355600 XX 99	\$8.60
6 pin Medeco <sup>3</sup>	KYB 356600 XX 99	\$8.60
5 pin Original/Biaxial	KYB 745600 XX 99	\$8.60
6 pin Original/Biaxial	KYB 746600 XX 99	\$8.60
6 pin Medeco KM	KYB 776600 XX 99	\$8.10
7 pin Medeco KM	KYB 777600 XX 99	\$8.10
6 pin Medeco X4 key blank	KYB 776900 XXX 99	\$8.10
7 pin Medeco X4 key blank	KYB 777900 XXX 99	\$9.30

Stamping is required on all restricted key blanks.

### Hybrid Blades only, no heads, cut keys

Description	Part Number	Price
5 pin Medeco <sup>3</sup>	KYC 355600 XX 99	\$20.90
6 pin Medeco <sup>3</sup>	KYC 356600 XX 99	\$20.90
5 pin Original/Biaxial	KYC 745600 XX 99	\$20.90
6 pin Original/Biaxial	KYC 746600 XX 99	\$20.90
6 pin Medeco KM	KYC 776600 XX 99	\$18.70
7 pin Medeco KM	KYC 777600 XX 99	\$18.70
6 pin Medeco X4 cut key	KYC 776900 XXX 99	\$18.70
7 pin Medeco X4 cut key	KYC 777900 XXX 99	\$18.70

\*\*Refer to the eCylinder section for more detail on specific technologies available and pricing. Technologies are represented by the following letters:  
 T = Medeco<sup>3</sup>, S = M<sup>3</sup> CLIQ, J = Medeco<sup>3</sup> BiLevel, W = Biaxial, V = Medeco Biaxial CLIQ, K = Medeco KM, N = Medeco X4, C = Classic CLIQ, M = Medeco X4 CLIQ,  
 “. ” = Original, Z = Medeco Original KW CLIQ, G = Medeco XT \*\*\*See key section for surcharges for custom coined cut keys or special stamping requirements.  
**Note:** (P) refers to **Pinned** and (S) to **Sub-Assembled** at the end of each part string in the price book.

**Medeco<sup>3</sup>/Biaxial Door Hardware Pin Kits**

Description	Part Number	Price
Medeco Biaxial 10 through 50 Series broached and milled pin combination (Door Hardware), Large Metal Box, 30 Each of Bottom, Master, Top Pins	.KW5005	\$909.00
Medeco Biaxial 10 Through 50 Series (Door Hardware), Large Metal Box, 100 Each of Bottom, Master, & Top Pins	.KW5006	\$1,985.00
Medeco Biaxial 10 Through 50 Series (Door Hardware), Small Metal Box, 10 Each of Bottom, Master & Top Pins	.KW5007	\$683.00
Medeco Biaxial Pin Kit with 30 ea. 53 Series (broached) Pins for Biaxial Cylinders with Sidebars Manufactured Prior to 2/2003	.KW5011	\$909.00
Medeco Biaxial Pin Kit with 100 ea. 53 Series (broached) Pins for Biaxial Cylinders with Sidebars Manufactured Prior to 2/2003	.KW5012	\$1,985.00
Medeco Biaxial Pin Kit for 32 Series LFIC Cylinders. 4, 5, and 6 Pins Only with 50 each 53 Series Pins	.KW5010	\$452.00
Medeco Biaxial/Medeco <sup>3</sup> Pin Kit for Medeco <sup>3</sup> CLIQ	.KW5401	\$685.00

**Medeco<sup>3</sup>/Biaxial Cam and Switch Lock Pin Kits**

Description	Part Number	Price
Medeco Biaxial 60 Series (Cam & Switch locks), 100 Each of Bottom Pins (Top Pins Not Used)	.K-9001	\$1,251.00
Medeco Biaxial 60 Series (Cam & Switch Locks), Small Metal Box, 10 Each of Bottom Pins (Top Pins Not Used)	.KW9003	\$400.00

**Medeco<sup>3</sup> BiLevel Pin Kits**

Description	Part Number	Price
Medeco <sup>3</sup> BiLevel Pin Kit (100 ea. BiLevel Top & Bottom Pins)	.KJ1501	\$796.00

**Medeco KM and X4 Pin Kits (Available in USA and Canada)**

Description	Part Number	Price
Medeco KM and X4 Pin Kit for SFIC; Large Wood Kit, 100 Each Bottom and Master/Top Pins. Springs, Caps, Spring Covers, Set Screws, Pinning Fixture, Capping Punch, Pin Ejector and Key Gauge Included.	.K-4001	\$1,059.00
Medeco KM and X4 mini Pin Kit for SFIC; Small Metal Pin Kit, 30 Each Bottom Pins, 60 Each Master/Top Pins. Springs, Caps, and Spring Covers included.	.K-4002	\$258.00
Medeco X4 Pin Kit for Conventional Cylinders (.511 plug), not SFIC; 100 Each Bottom and Master/Top Pins. Springs, Spring Covers, Set Screws, and Key Gauge included.	.K-4006	\$769.00

**Medeco KM and X4 Pin Kits (Available in Canada Only)**

Description	Part Number	Price
Medeco KM Pin Kit; (Classic Only) Large Wooden Pin Kit, 100 Each Bottom, Master & Top Pins. Spring, Caps, Spring Covers, Set Screws, Pinning Fixture, Capping Punch, Pin Ejector & Key Gauge also included	K-4003	\$1,091.00
Medeco KM Mini Pin Kit; (Classic Only) Small Metal Pin Kit, 30 Bottom Pins, 60 Each of Master & Top Pins, Springs, Caps, Spring Covers, & Set Screws also included.	K-4004	\$265.00

Contact Factory for LFIC Pinning Requirements.

\*\*Refer to the eCylinder section for more detail on specific technologies available and pricing. Technologies are represented by the following letters:  
 T = Medeco<sup>3</sup>, S = M<sup>3</sup> CLIQ, J = Medeco<sup>3</sup> BiLevel, W = Biaxial, V = Medeco Biaxial CLIQ, K = Medeco KM, N = Medeco X4, C = Classic CLIQ, M = Medeco X4 CLIQ,  
 “. ” = Original, Z = Medeco Original KW CLIQ, G = Medeco XT \*\*\*See key section for surcharges for custom coined cut keys or special stamping requirements.  
**Note:** (P) refers to **Pinned** and (S) to **Sub-Assembled** at the end of each part string in the price book.

**Medeco Original Door Hardware Pin Kits**

Description	Part Number	Price
Medeco Original Door Hardware Pins, Full Step, Metal Box, 30 Ea. of Bottom & Top Pins	.K-1001	\$412.00
Medeco Original Door Hardware Pins, Full Step, Metal Box, 100 Ea. of Bottom & Top Pins	.K-1002	\$1,204.00
Medeco Original Door Hardware Pins, Full Step, Plastic Box, 100 Ea. of Master Pins #1 - #5 Only	.K-1003	\$88.50
Medeco Original Door Hardware Pins, Small Metal Box, 10 Ea. of Bottom, Master, & Top Pins	.K-1005	\$410.00
Medeco Original Door Hardware Pins, 1/2 Step, Large Metal Box, 100 Ea. of Bottom, Master & Top Pins	.K-1006	\$1,991.00

**Medeco Original Cam & Switch Lock Pin Kits**

Description	Part Number	Price
Medeco Original Cam & Switch Type Pins, Full Step, Plastic Box, 100 Ea. of Bottom Pins (Top Pins Not Used)	.K-6001	\$997.00
Medeco Original Cam & Switch Style Pins, Full Step, Plastic Box, 100 Ea. of Master Pins (Top Pins Not Used)	.K-6002	\$1,166.00

**Pins (Sold in bags of 100)**

Description	Part Number	Price
Medeco Original Bottom Pins (.030" increment)	TP-F10-XX	\$1.10
Medeco Original Master Wafers (.030" increment)	TP-F10-XW	\$0.41
Mushroom driver	TP-F10-3M	\$0.71
Standard Driver	TP-F10-XT	\$0.43
Medeco <sup>3</sup> /Biaxial Bottom Pins (.025" increment)	TP-F50-XX	\$1.10
Medeco <sup>3</sup> /Biaxial Master Wafers (.025 increment)	TP-F50-XW	\$0.41
Original 60 Series Pins	TP-F60-XX	\$1.10
Medeco <sup>3</sup> /Biaxial 60 Series Pins (.025 increment)	TP-F90-XX	\$1.10
Medeco KM and X4 Bottom Pins, #0B-9B (qty of 100 pack) Note: Medeco X4 SFIC only	TP-K40-XX-BH	\$11.40
Medeco KM and X4 Top Pins #02-19T (qty of 100 in pack)	TP-K40-XX-TH	\$10.30
Medeco X4 Bottom Pins for Conventional Cylinders #00-09	TP-K43-XX-BH	\$16.70
Medeco BiLevel Top Pins	TP-F15-XT	\$0.42
Medeco BiLevel Bottom Pins (.025 increment)	TP-F15-XB	\$0.52
Medeco <sup>3</sup> /Medeco Biaxial Broached Bottom Pins (.025" increment)	TP-F53-XX	\$1.10
KM Offset Top Pin	TP-K42-Z9	\$1.10

\*\*Refer to the eCylinder section for more detail on specific technologies available and pricing. Technologies are represented by the following letters:  
T = Medeco<sup>3</sup>, S = M<sup>3</sup> CLIQ, J = Medeco<sup>3</sup> BiLevel, W = Biaxial, V = Medeco Biaxial CLIQ, K = Medeco KM, N = Medeco X4, C = Classic CLIQ, M = Medeco X4 CLIQ,  
"." = Original, Z = Medeco Original KW CLIQ, G = Medeco XT \*\*\*See key section for surcharges for custom coined cut keys or special stamping requirements.  
**Note: (P)** refers to **Pinned** and **(S)** to **Sub-Assembled** at the end of each part string in the price book.

**Caps (Sold in bags of 100)**

Description	Part Number	Price
Medeco X4 I/C Pin Spring Caps (Stamped) (for rekeying)	CP-170430	\$5.40
Medeco X4 I/C Pin Spring Caps (Machined) (for new cylinder)	CP-170440	\$5.40
Spring Covers for Medeco LFIC, Corbin (7 pin) LFIC, and Yale LFIC (6 and 7 pin), Brass, 1.010" Length	CP-170011	\$0.50
5 Pin Spring Covers for Medeco 32 Series I/C, Cam and Switch Lock Plugs, Brass, .840" Length	CP-170021	\$0.50
3 Pin Spring Covers for Cam and Switch Lock Plugs, Brass, .500" Length	CP-170031	\$0.50
4 Pin Spring Covers for Cam and Switch Lock Plugs, Brass, .670" Length	CP-170041	\$0.50
6 Pin Spring Covers for Medeco and Medeco X4 20 Series Key-in-Knob Cyls (Old Style), Schlage LFIC, Stainless Steel, .980" Length	CP-170051	\$0.50
5 Pin Spring Covers for Medeco 20 Series Key-in-Knob Cyls (Old Style), Stainless Steel, .810" Length	CP-170061	\$0.50
6 Pin Spring Covers for Medeco <sup>3</sup> 32*0202 Removable Cylinder for 50 Series Brass Body Padlocks, Brass, 1.010" Length (Notch in cover for steel ball bearing retainer)	CP-170271	\$0.50
6 Pin Spring Covers for Medeco & Medeco X4 20 Series Key-in-Knob Cylinders & Medeco X4 Schlage Style LFIC	CP-170730-6	\$0.57
5 Pin Spring Covers for Medeco 20 Series Key-in-Knob Cylinders	CP-170730-5	\$0.57
6 Pin Spring Cover for Corbin and Sargent LFIC	CP-170481	\$0.50

**Springs (Sold in bags of 100)**

Description	Part Number	Price
Tumbler Springs, 10 Series Door Hardware	CP-030001	\$0.09
Tumbler Springs, 60 Series Cam & Switch Locks	CP-030017	\$0.09
Sidebar Springs	CP-030018	\$0.09
Tumbler Springs, 32 Series (stainless steel)	CP-030042	\$0.10
Medeco <sup>3</sup> Slider Springs	CP-030910	\$0.10
Medeco X4 Springs (Bag of 300)	CP-030590	\$17.30

\*\*Refer to the eCylinder section for more detail on specific technologies available and pricing. Technologies are represented by the following letters:  
T = Medeco<sup>3</sup>, S = M<sup>3</sup> CLIQ, J = Medeco<sup>3</sup> BiLevel, W = Biaxial, V = Medeco Biaxial CLIQ, K = Medeco KM, N = Medeco X4, C = Classic CLIQ, M = Medeco X4 CLIQ,  
"." = Original, Z = Medeco Original KW CLIQ, G = Medeco XT \*\*\*See key section for surcharges for custom coined cut keys or special stamping requirements.

**Note:** (P) refers to **Pinned** and (S) to **Sub-Assembled** at the end of each part string in the price book.

**Screws (Sold in bags of 100)**

Description	Part Number	Price
#2-56 x 3/16" Flat Head Cam Screw for 10-0100 Cylinder	CP-010203-030	\$0.21
#2-56 x 1/4" Flat Head Screw for 32 Series I/C Housing	CP-010103-040	\$0.59
#2-56 x 5/16" Flat Head Phillips, Nylon Patch Cam Screw for Mortise Cylinders	CP-010203-050	\$0.21
#2-56 x 1/4" Pan Head Screw for 20-0901 and Other Lazy Motion Retainers	CP-010503-040	\$0.33
#8-32 x 1/8" Allen Set Screw Cone for Pin Chambers (10 Series Rim & Mortise)	CP-011013-020	\$0.26
#8-32 x 1/4" Allen Set Screw Cone for Pin Chambers (23 Series Profile Cylinders)	CP-011013-040	\$0.37
Set Screw for non-I/C Medeco X4 Rim & Mortise Cylinders	CP-011011-020	\$0.22

**Misc. Components**

Description	Part Number	Price
5 Pin Sidebar Assembly .123" for Door Hardware Cylinders	CP-084571	\$7.20
6 Pin Sidebar Assembly .123" for Door Hardware Cylinders	CP-084671	\$7.20
Medeco <sup>3</sup> Slider and Spring Package	94-0174-XX	\$12.00
Medeco BiLevel Slider and Spring Package	94-0227-XX	\$12.00
Medeco X4 Conventional Slider and Spring Package	94-0255-XX	\$12.00
Medeco X4 SFIC Slider and Spring Package	94-0256-XX	\$12.00
Medeco X4 Conventional Locking Pin	CP-064231	\$4.10
Medeco X4 Conventional Locking Pin Spring (Pack of 100)	CP-031170	\$0.32
Medeco X4 SFIC Locking Pin	CP-064701	\$11.90
Medeco X4 SFIC Locking Pin Spring (Pack of 100)	CP-031480	\$0.32

**Cam & Tailpiece Kit**

Description	Part Number	Price
10 and 20 Series Tailpieces (Plastic Box, Assorted Cams and Tailpieces for 10 & 20 Series) Includes: CT-Y02, CT-Y08, CT-Y24, CTY32, CT-Y49, CT-Y52, CT-Y53, CT-Z00, CT-Z01, CT-Z02, CT-Z04, CT-Z06, CT-Z07, CT-Z08, CTZ09, CT-Z16	.K-1099	\$551.00

**Empty Pin Boxes - Any Technology**

Description	Part Number	Price
Large Latched Metal Pin Box (Empty) 60 Assorted Size Compartments. Overall Measurements 1.875" Deep, 13.56" wide, 9.75 front to back.	CP-282460	\$219.00
Small Latched Metal Pin Box (Empty) 67 Assorted Size Compartments, Overall .688" Deep, 8.876" Wide, 5.875" Front to Back	CP-282470	\$132.00

**Pin Hole Covers for 60 Series (sold in bags of 100)**







Description	Part Number	Price
5 Pin, Pin Hole Covers-Brass	CP-170021	\$0.50
4 Pin, Pin Hole Covers-Brass	CP-170041	\$0.50
3 Pin, Pin Hole Covers-Brass	CP-170031	\$0.50

\*\*Refer to the eCylinder section for more detail on specific technologies available and pricing. Technologies are represented by the following letters:  
 T = Medeco<sup>3</sup>, S = M<sup>3</sup> CLIQ, J = Medeco<sup>3</sup> BiLevel, W = Biaxial, V = Medeco Biaxial CLIQ, K = Medeco KM, N = Medeco X4, C = Classic CLIQ, M = Medeco X4 CLIQ,  
 ".-" = Original, Z = Medeco Original KW CLIQ, G = Medeco XT \*\*\*See key section for surcharges for custom coined cut keys or special stamping requirements.

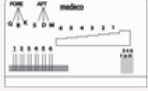
**Note:** (P) refers to **Pinned** and (S) to **Sub-Assembled** at the end of each part string in the price book.



## Tools &amp; Fixtures

Description	Part Number	Price
Spanner Wrench for Rim Cylinder Tailpiece Nut	90-0001	\$3.30
 Medeco³/Biaxial Key Gauge/Decoder	94-0298	\$30.30
Installation Tool for Key-in-Knob capping	94-0207	\$1.80 (NET)
 5 Pin Staking Tool, 60 Series Cam/ Switch Locks and 32 Series LFIC	CP-282430	\$121.00
 Holding Block Assembly (use with 10, 20, 32, & 60 Series Cylinders)	CP-282451	\$878.00
 Switch Lock Tool (Facilitates spring insertion on momentary function)	T-7155	\$26.90
 Medeco X4 I/C Pinning Block (6 or 7 Pin)	CP-282500	\$183.00
 Medeco X4 I/C Pin Ejector	CP-282530	\$44.80
 Medeco X4 I/C Hand Capping Punch	CP-282540	\$29.00
Medeco X4 Key Decoder	CP-286350	\$33.10

## Lubricants

Description	Part Number	Price
Fluid Film (2.25oz.) Spray	PX-KYLUBE-02	\$17.30
Fluid Film (11.75oz.) Spray	PX-KYLUBE-11	\$27.60

\*\*Refer to the eCylinder section for more detail on specific technologies available and pricing. Technologies are represented by the following letters:  
T = Medeco³, S = M³ CLIQ, J = Medeco³ BiLevel, W = Biaxial, V = Medeco Biaxial CLIQ, K = Medeco KM, N = Medeco X4, C = Classic CLIQ, M = Medeco X4 CLIQ,  
“-” = Original, Z = Medeco Original KW CLIQ, G = Medeco XT \*\*\*See key section for surcharges for custom coined cut keys or special stamping requirements.  
**Note:** (P) refers to **Pinned** and (S) to **Sub-Assembled** at the end of each part string in the price book.

## Key Machines

Description	Part Number	Price
Key Machine, Original, 115V	95-M11000	\$12,612.00
Key Machine, Biaxial, 115V	95-M23000	\$12,612.00
Key Machine, Universal, 115V	95-M34000	\$13,422.00
Key Machine, KM, 115V	95-M45000	\$12,612.00
Key Machine, Medeco X4, 115V	95-M55000	\$12,612.00
Key Machine, Medeco X4 A2/A4, 115V	95-M56000	\$13,062.00
Medeco KM Key Punch Machine	95-000200	\$3,434.00
Medeco X4 Key Punch Machine	95-001100	\$3,434.00

Power Key Machines are also available in 220V versions. Ask your customer service representative for details.  
Note: Key Machines do not include keyway specific clamps. Must order from clamps shown below.



## Key Machine Parts

Description	Part Number	Price
Clamp Kit (Clamp, Handle, Plunger, QC Pin) -XX / Keyway	95-210100-XX	\$719.00
Clamp Kit (Clamp, Handle, Plunger, QC Pin) - MED3 / Medeco <sup>3</sup>	95-210100-MED3	\$719.00
Clamp Kit (Clamp, Handle, Plunger, QC Pin) - UNIV / Universal (Selected Biax)	95-210100-UNIV	\$719.00
Clamp Retrofit Kit (Clamp, Handle, Plunger) - XX / Keyway	95-210130-XX	\$647.00
Clamp Retrofit Kit (Clamp, Handle, Plunger) - MED3 / Medeco <sup>3</sup>	95-210130-MED3	\$647.00
Clamp Retrofit Kit (Clamp, Handle, Plunger) - UNIV / Universal (Selected Biax)	95-210130-UNIV	\$647.00

## Key Machine Cutters

Description	Part Number	Price
Cutter for all High Security technologies	95-100400	\$511.00
Cutter for Medeco X4 key machine	95-100070	\$511.00
Re-Sharpener Cutter – Must provide cutter for re-sharpening exchange	KM-SHARP-CUT	\$193.00

## Key Wizard® Key Management Software

Description	Part Number	Price
Key Wizard Key Management Software Yearly Support, Upgrade, and Maintenance Fee **PRICE SHOWN IS NET**	SW-500001	\$159.00 (NET)
Key Wizard Key Management Software Single-User Version*	SW-600001	\$1,229.00
Key Wizard Key Management Software Network Version*	SW-600201	\$1,444.00
Key Wizard Key Management Software Single User Upgrade To Network Version*	SW-600401	\$742.00

Note: Visit [www.keywizard.net](http://www.keywizard.net) for more information.

\*\*Refer to the eCylinder section for more detail on specific technologies available and pricing. Technologies are represented by the following letters:  
T = Medeco<sup>3</sup>, S = M<sup>3</sup> CLIQ, J = Medeco<sup>3</sup> BiLevel, W = Biaxial, V = Medeco Biaxial CLIQ, K = Medeco KM, N = Medeco X4, C = Classic CLIQ, M = Medeco X4 CLIQ,  
“.” = Original, Z = Medeco Original KW CLIQ, G = Medeco XT \*\*\*See key section for surcharges for custom coined cut keys or special stamping requirements.  
**Note: (P)** refers to **Pinned** and **(S)** to **Sub-Assembled** at the end of each part string in the price book.

Product No.	Page	Product No.	Page	Product No.	Page	Product No.	Page
12286	140	50047341	41	100700 C	49	105100 (S)	65
12288	140	50048321	41	100702 (P)	90	105100 C	49
13327	140	50048341	41	100702 (S)	90	105100 G	27
13346	140	50762011	42	100903 (P)	68	105104 (P)	65
13365	140	50762014	42	100903 (S)	68	105104 (S)	65
13375	140	50762111	42	100909 (P)	68	105200	37
120280	155	50762114	42	100909 (S)	68	105200 (P)	65
120290	155	50772011	42	1012040 (P)	88	105200 (S)	65
123620	155	50772014	42	1012040 (S)	88	105200 C	49
124340	155	50772111	42	101350 (P)	67	105300 (P)	65
200503	39	50772114	42	101350 (S)	67	105300 (S)	65
200901	37, 40	52110040	173	101355 (P)	71	105400	37
200902	37, 40	52120040	173	101355 (S)	71	105400 (P)	65
200904	40	100100 (P)	65	1014500 (P)	66	105400 (S)	65
310100	39	100100 (S)	65	1014500 (S)	66	105400 C	49
320201	39, 42	100101 (P)	65	1014501 (P)	66	105500 (P)	65
500020	41	100101 (S)	65	1014501 (S)	66	105500 (S)	65
510600	41	100200	37	1014502 (P)	66	105500 C	49
526000	169	100200 (P)	65	1014502 (S)	66	105600 (P)	65
526002	169	100200 (S)	65	1014503 (P)	66	105600 (S)	65
526010	169	100200A (P)	68	1014503 (S)	66	105700 (P)	65
526012	169	100200A (S)	68	1014504 (P)	66	105700 (S)	65
526100	169	100202 (P)	68	1014504 (S)	66	105700 C	49
526102	169	100202 (S)	68	1014505 (P)	66	105800 (P)	65
526110	169	100300H (P)	71	1014505 (S)	66	105800 (S)	65
526112	169	100300H (S)	71	1014506 (P)	66	105900 (P)	65
526200	168	100300V (P)	71	1014506 (S)	66	105900 (S)	65
526202	168	100300V (S)	71	1014507 (P)	66	105901 (P)	65
526210	168	100305H (P)	71	1014507 (S)	66	105901 (S)	65
526212	168	100305H (S)	71	1014508 (P)	66	105902 (P)	65
526302	168	100305V (P)	71	1014508 (S)	66	105902 (S)	65
526310	168	100305V (S)	71	1014509 (P)	66	105903 (P)	65
526312	168	100400H	37	1014509 (S)	66	105903 (S)	65
650003	189	100400H (P)	71	1014600 (P)	66	105904 (P)	65
940010	71	100400H (S)	71	1014600 (S)	66	105904 (S)	65
940174	91	100400H C	49	1014601 (P)	66	1065140 (P)	87
940219	130	100400H G	27	1014601 (S)	66	1065140 (S)	87
940227	91	100400V	37	1014602 (P)	66	1065154 (P)	89
940243	130	100400V (P)	71	1014602 (S)	66	1065154 (S)	89
940261	35	100400V (S)	71	1014603 (P)	66	1065244 (P)	87
940264	35	100400V C	49	1014603 (S)	66	1065244 (S)	87
940279	130	100400V G	27	1014604 (P)	66	1065254 (P)	89
1202800	151	100403H	37	1014604 (S)	66	1065254 (S)	89
1202900	151	100403H (S)	71	1014605 (P)	66	1066154 (P)	89
2020000	38, 41	100403H C	49	1014605 (S)	66	1066154 (S)	89
2020049	38	100403V	37	1014607 (P)	66	1066254 (P)	89
2020052	41	100403V (P)	71	1014607 (S)	66	1066254 (S)	89
2020073	38	100403V (S)	71	1014608 (P)	66	1075127 (P)	87
2020074	41	100403V C	49	1014608 (S)	66	1075127 (S)	87
2020078	39	100500	37	1014609 (P)	66	108001 (P)	67
2020097	39	100500 (P)	65	1014609 (S)	66	108001 (S)	67
2021173	38	100500 (S)	65	10400 CUT J	193	108002 (P)	67
2080147	39	100500 C	49	10400 CUT T	193	108002 (S)	67
2080148	39	100500 G	27	104001 (P)	67	11-0018	152
3307311	186	100500H (P)	67	104001 (S)	67	11-0092	152
3307321	186	100500H (S)	67	104003 (P)	67	11-0A10	152
3307331	186	100501 (P)	67	104003 (S)	67	11-0A12	152
3307350	186	100501 (S)	67	104207 (P)	68	11-0A14	152
5004732	41	100600 (P)	71	104207 (S)	68	11-0A16	152
5004734	41	100600 (S)	71	104207A (P)	68	11-0A17	152
5004832	41	100602 (P)	90	104207A (S)	68	11-0A18	152
5004834	41	100602 (S)	90	104407HA (P)	71	11-0A20	152
6270515	186	100700	37	104407HA (S)	71	11-0A21	152
6271515	186	100700 (P)	71	105100	37	11-0A22	152
50047321	41	100700 (S)	71	105100 (P)	65	11-0A23	152

Product No.	Page	Product No.	Page	Product No.	Page	Product No.	Page
110A00 (P)	151	11C326 (S)	149	11C622 (P)	148	11C721	150
110A00 (S)	151	11C32L (P)	149	11C622 (S)	148	11C722	150
110A01 (P)	151	11C32L (S)	149	11C623	40	11C723	150
110A01 (S)	151	11C341 (P)	145	11C623 (P)	148	11C724	150
110A02 (P)	151	11C341 (S)	145	11C623 (S)	148	11C725	150
110A02 (S)	151	11C342 (P)	145	11C624	40	11C726	150
110A03 (P)	151	11C342 (S)	145	11C624 (P)	148	11C801 (P)	146
110A03 (S)	151	11C391 (P)	145	11C624 (S)	148	11C801 (S)	146
110A04 (P)	151	11C391 (S)	145	11C625	40	11C802 (P)	146
110A04 (S)	151	11C392 (P)	145	11C625 (P)	148	11C802 (S)	146
110A05 (P)	151	11C392 (S)	145	11C625 (S)	148	11C803 (P)	146
110A05 (S)	151	11C401	145	11C626	40	11C803 (S)	146
110A06 (P)	151	11C402	145	11C626 (P)	148	11C804 (P)	146
110A06 (S)	151	11C405	145	11C626 (S)	148	11C804 (S)	146
110A07 (P)	151	11C406	145	11C62L	40	11C805 (P)	146
110A07 (S)	151	11C421	149	11C62L (P)	148	11C805 (S)	146
110A08L	151	11C422	149	11C62L (S)	148	11C806 (P)	146
110A09L	151	11C425	149	11C631 (P)	148	11C806 (S)	146
110A1911	151	11C426	149	11C631 (S)	148	11C811 (P)	146
110A1912	151	11C601	40	11C631T (P)	148	11C811 (S)	146
110A1913	151	11C601 (P)	144	11C631T (S)	148	11C812 (P)	146
110A1921	151	11C601 (S)	144	11C632 (P)	148	11C812 (S)	146
110A1922	151	11C601 C	53	11C632 (S)	148	11C813 (P)	146
110A1923	151	11C602	40	11C632T (P)	148	11C813 (S)	146
11C281	144	11C602 (P)	144	11C632T (S)	148	11C814 (P)	146
11C282	144	11C602 (S)	144	11C633 (P)	148	11C814 (S)	146
11C301 (P)	145	11C602 C	53	11C633 (S)	148	11C815 (P)	147
11C301 (S)	145	11C603	40	11C633T (P)	148	11C815 (S)	147
11C302 (P)	145	11C603 (P)	144	11C633T (S)	148	11C816 (P)	147
11C302 (S)	145	11C603 (S)	144	11C634 (P)	148	11C816 (S)	147
11C303 (P)	145	11C603 C	53	11C634 (S)	148	11C821 (P)	150
11C303 (S)	145	11C604	40	11C634T (P)	148	11C821 (S)	150
11C304 (P)	145	11C604 (P)	144	11C634T (S)	148	11C822 (P)	150
11C304 (S)	145	11C604 (S)	144	11C635 (P)	148	11C822 (S)	150
11C305 (P)	145	11C604 C	53	11C635 (S)	148	11C823 (P)	150
11C305 (S)	145	11C605	40	11C635T (P)	148	11C823 (S)	150
11C306 (P)	145	11C605 (P)	144	11C635T (S)	148	11C824 (P)	150
11C306 (S)	145	11C605 (S)	144	11C636 (P)	148	11C824 (S)	150
11C30L (P)	145	11C605 C	53	11C636 (S)	148	11C825 (P)	150
11C30L (S)	145	11C606	40	11C636T (P)	148	11C825 (S)	150
11C311 (P)	145	11C606 (P)	144	11C636T (S)	148	11C826 (P)	150
11C311 (S)	145	11C606 (S)	144	11C63L (P)	148	11C826 (S)	150
11C312 (P)	145	11C606 C	53	11C63L (S)	148	11C841 (P)	147
11C312 (S)	145	11C60L	40	11C63LT (P)	148	11C841 (S)	147
11C313 (P)	145	11C60L (P)	144	11C63LT (S)	148	11C842 (P)	147
11C313 (S)	145	11C60L (S)	144	11C641 (P)	144	11C842 (S)	147
11C314 (P)	145	11C60L C	53	11C641 (S)	144	11C891 (P)	147
11C314 (S)	145	11C611 (P)	144	11C642 (P)	144	11C891 (S)	147
11C315 (P)	145	11C611 (S)	144	11C642 (S)	144	11C892 (P)	147
11C315 (S)	145	11C612 (P)	144	11C691 (P)	144	11C892 (S)	147
11C316 (P)	145	11C612 (S)	144	11C691 (S)	144	11C901 (P)	147
11C316 (S)	145	11C613 (P)	144	11C692 (P)	144	11C901 (S)	147
11C31L (P)	145	11C613 (S)	144	11C692 (S)	144	11C902 (P)	147
11C31L (S)	145	11C614 (P)	144	11C701	146	11C902 (S)	147
11C321 (P)	149	11C614 (S)	144	11C702	146	11C903 (P)	147
11C321 (S)	149	11C615 (P)	144	11C703	146	11C903 (S)	147
11C322 (P)	149	11C615 (S)	144	11C704	146	11C904 (P)	147
11C322 (S)	149	11C616 (P)	144	11C705	146	11C904 (S)	147
11C323 (P)	149	11C616 (S)	144	11C706	146	11C905 (P)	147
11C323 (S)	149	11C61L (P)	144	11C711	146	11C905 (S)	147
11C324 (P)	149	11C61L (S)	144	11C712	146	11C906 (P)	147
11C324 (S)	149	11C621	40	11C713	146	11C906 (S)	147
11C325 (P)	149	11C621 (P)	148	11C714	146	11C911 (P)	147
11C325 (S)	149	11C621 (S)	148	11C715	146	11C911 (S)	147
11C326 (P)	149	11C622	40	11C716	146	11C912 (P)	147

Product No.	Page	Product No.	Page	Product No.	Page	Product No.	Page
11C912 (S)	147	11R623 (S)	155	2001851 (S)	87	2020070 (P)	82
11C913 (P)	147	11R624	40	200500 (P)	86	2020070 (S)	77
11C913 (S)	147	11R624 (P)	155	200500 (S)	86	2020070 (S)	82
11C914 (P)	147	11R624 (S)	155	200503 (P)	86	2020070 C	50
11C914 (S)	147	11R625	40	200503 (S)	86	2020071 (P)	77, 81
11C915 (P)	147	11R626	40	200503 C	51	2020071 (S)	77, 81
11C915 (S)	147	11R62L	40	200503 G	30	2020072 (P)	81
11C916 (P)	147	11R633 (P)	155	200700 (P)	85	2020072 (S)	81
11C916 (S)	147	11R633 (S)	155	200700 (S)	85	2020073 (P)	77,81,82,85,86
11C921 (P)	150	11R634 (P)	155	200701 (P)	85	2020073 (S)	77,81,82,85,86
11C921 (S)	150	11R634 (S)	155	200701 (S)	85	2020073 C	50
11C922 (P)	150	11R67L	155	200801 (P)	87, 88	2020073 G	29, 30
11C922 (S)	150	11R6DL	155	200801 (S)	87, 88	2020074 (P)	91
11C923 (P)	150	1200100 T	72	200802 (P)	87, 88	2020074 (S)	91
11C923 (S)	150	12001002 -	72	200802 (S)	87, 88	2020074 C	52
11C924 (P)	150	12001006 W	72	200802 (S)	88	2020078 (P)	82
11C924 (S)	150	1200500 T	68	200807 (P)	88	2020078 (S)	82
11C925 (P)	150	12005002 -	68	200807 (S)	88	2020078 C	51
11C925 (S)	150	12005006 W	68	200808 (P)	88	2020097 (P)	85
11C926 (P)	150	1202000 T	68	200808 (S)	88	2020097 (S)	85
11C926 (S)	150	12020002 -	68	200901 (P)	87, 88	2020097 G	30
11C941 (P)	147	12020006 W	68	200901 (S)	87, 88	20200A1	37
11C941 (S)	147	1202100 T	68	200901 C	53	20200A1 (P)	77
11C942 (P)	147	12021002 -	68	200902 (P)	87, 88	20200A1 (S)	77
11C942 (S)	147	12021006 W	68	200902 (S)	87, 88	20200A1 C	50
11C991 (P)	147	1203000 T	72	200902 C	53	20200A1 G	29
11C991 (S)	147	12030002 -	72	200903 (P)	81, 88, 90	20200F1	38
11C992 (P)	147	12030006 W	72	200903 (S)	81, 88, 90	20200F1 (P)	81
11C992 (S)	147	12126002 -	91	200904 (P)	89	20200F1 (S)	81
11R503 (P)	155	12126156 W	91	200904 (S)	89	20200F1 G	30
11R503 (S)	155	1212633 T	91	200904 C	53	20200H1 (P)	77, 85
11R504 (P)	155	1238900 J	72	200907 (P)	88	20200H1 (S)	77, 85
11R504 (S)	155	1239000 J	68	200907 (S)	88	20200L1	38
11R523 (P)	155	1239100 J	68	200908 (P)	88	20200L1 (P)	82
11R523 (S)	155	1251200 J	72	200908 (S)	88	20200L1 (S)	82
11R524 (P)	155	1251300 J	68	201006 (P)	82	20200L1 C	50
11R524 (S)	155	2000400 (P)	85	201006 (S)	82	20200L1 G	30
11R533 (P)	155	2000400 (S)	85	201006 G	131	20200S1	39
11R533 (S)	155	2000700 (P)	85	20110039 (P)	77	20200S1 (P)	78, 83, 86
11R534 (P)	155	2000700 (S)	85	20110039(S)	77	20200S1 (S)	78, 83, 86
11R534 (S)	155	2000800 (P)	89	20112B1 G	131	20200S1 C	51
11R57L	155	2000800 (S)	89	2020000 (P)	90	20200S1 G	30
11R5DL	155	2000827 (P)	83, 84	2020000 (S)	90	20200V0	38
11R601	40	2000827 (S)	84, 84	2020000 C	50, 52	20200V0	38, 39
11R601 C	53	2000854 (S)	89	2020000 G	30	20200V0 (P)	80, 83
11R602	40	2000900 (P)	89	2020049	38	20200V0 (S)	80, 83
11R602 C	53	2000900 (S)	89	2020049 (P)	77,78,80,81,85	20200V0 C	50, 51
11R603	40	2000954	39	2020049 (S)	77,78,80,81,85	20200V0 G	30
11R603 (P)	155	2000954 (P)	83, 87, 89	2020049 C	50	20200V1	38, 39
11R603 (S)	155	2000954 (S)	83, 87, 89	2020049 G	29	20200V1 (P)	77
11R603 C	53	2000S4 (P)	89	2020051 (P)	81, 85	20200V1 (P)	78, 80, 82, 83
11R604	40	200104 J	91	2020051 (S)	81, 85	20200V1 (S)	78, 80, 82, 83
11R604 (P)	155	2001200 (P)	78	2020051 G	30	20200V1 C	49
11R604 (S)	155	2001200 (S)	78	2020052 (P)	85, 91	20200V1 C	50, 51
11R604 C	53	2001300 (P)	78	2020052 (S)	85, 91	20200V1 G	29
11R605	40	2001300 (S)	78	2020052 C	52	20200V1 G	30
11R605 C	53	2001400 (P)	85	2020053 (P)	85	20200V2	39
11R606	40	2001400 (S)	85	2020053 (S)	85	20200V2 (P)	84
11R606 C	53	200155 K	91	2020054 (P)	81	20200V2 (S)	84
11R60L	40	200156 N	91	2020054 (S)	81	20200V2 C	51
11R60L C	53	2001600 (P)	170	2020058 (P)	81	20200V2 G	30
11R621	40	2001600 (S)	170	2020058 (S)	81	20200V3	38
11R622	40	2001700 (P)	85	2020068 (P)	81	20200V3 (P)	81
11R623	40	2001700 (S)	85	2020068 (S)	81	20200V3 (S)	81
11R623 (P)	155	2001851 (P)	87	2020070 (P)	77	20200V3 G	30

Product No.	Page	Product No.	Page	Product No.	Page	Product No.	Page
20200V9	38	2080148 (S)	84	2313026 X12 (P)	138	2324D21	113
20200V9 (P)	79	2080700 (P)	77, 86	2313026 X12 (S)	138	2324D25	113
20200V9 (S)	79	2080700 (S)	77, 86	2313035 X00 (P)	137	2324H01	113
20200V9 C	50	210503 (P)	177	2313035 X00 (S)	137	2324H05	113
20200V9 G	29	210503 (S)	177	2313036 X00 (P)	137	2324S12X	113
2020149 (P)	84	2301016 (P)	139	2313036 X00 (S)	137	2324S15X	113
2020149 (S)	84	2301016 (S)	139	2313045 X00 (P)	137	2324S52X	113
2020169 (P)	82	23010168 (P)	139	2313045 X00 (S)	137	2325005 C	55
2020169 (S)	82	23010168 (S)	139	2313046 X00 (P)	137	2325025 C	55
2020170 (P)	84	2303016A (P)	139	2313046 X00 (S)	137	2326D21	113
2020170 (S)	84	2303015 G	33, 131	2313055 X00 (P)	137	2326H01	113
2020173 (P)	84	2304005 (P)	139	2313055 X00 (S)	137	2326S12X	113
2020173 (S)	84	2304005 (S)	139	2313056 X00 (P)	137	31-0153H	103
2020249 (P)	77, 82, 83, 86	2304006 (P)	139	2313056 X00 (S)	137	31-0153V	103
2020249 (S)	77, 82, 83, 86	2304006 (S)	139	2313065 X00 (P)	137	31-0175	101
2020249 C	50, 51	2304015 (P)	139	2313065 X00 (S)	137	31-0175A	101
2020349 (P)	84	2304015 (S)	139	2313066 X00 (P)	137	31-0375H	103
2020349 (S)	84	2304016 (P)	139	2313066 X00 (S)	137	31-0375S	103
2020575 (P)	79	2304016 (S)	139	2314003 (P)	139	31-0375V	103
2020575 (S)	79	2304025 (P)	139	2314003 (S)	139	31-5375	101
2020777 (P)	79	2304025 (S)	139	2315005 (P)	139	310100 (P)	98
2020777 (S)	79	2304026 (P)	139	2315005 (S)	139	310100 (S)	98
2021173 C	50	2304026 (S)	139	2316004 (P)	139	310100 G	29
20211730 (P)	79	2305016 (P)	139	2316004 (S)	139	310100A	39
20211730 (S)	79	2305016 (S)	139	2317016 (P)	139	310100A (P)	98
203000 (P)	84	2305015 G	131	2317016 (S)	139	310100A (S)	98
203000 (S)	84	2306016 (P)	139	2320016 (P)	139	310100A G	29
205003 (P)	79	2306016 (S)	139	2320016 (S)	139	310100CC BI R1	98
205003 (S)	79	23070165 (P)	139	2322015 300	130	310101 (P)	100
205004 (P)	79	23070165 (S)	139	2322015 301	130	310101 (S)	100
205004 (S)	79	23080166 (P)	139	2322016 300	130	310101A (P)	100
205005 (P)	79	23080166 (S)	139	2322016 300 S	42, 131	310101A (S)	100
205005 (S)	79	2309016 (P)	139	2322016 301	130	310102H	102
205005 C	50	2309016 (S)	139	2322016 301 S	42, 131	310102H (S)	102
205006 (P)	79	2310016 (P)	139	2322017 300 N	130	310102V (P)	102
205006 (S)	79	2310016 (S)	139	2322015 300 G	33, 131	310102V (S)	102
205008 (P)	79	23130 CUT	193	2322015 301 G	33, 131	310104H (P)	102
205008 (S)	79	2313005 X00 (P)	137	2322015 302 G	33, 131	310104H (S)	102
2051027 (P)	87, 90	2313005 X00 (S)	137	2322025 300 G	33	310104V (P)	102
2051027 (S)	87, 90	2313006 X00 (P)	137	2322025 301 G	33	310104V (S)	102
2051100 (P)	80	2313006 X00 (S)	137	2322025 302 G	33	32-0175	101
2051100 (S)	80	2313015 800 (P)	138	23220X5 300	131	32-0275	101
2051200 (P)	80	2313015 800 (S)	138	23220X5 302	131	32-0375H	103
2051200 (S)	80	2313015 801 (P)	138	23220X6 300	131	32-0375V	103
2051500 (P)	82	2313015 801 (S)	138	23220XS 300	131	32-0475H	103
2051500 (S)	82	2313016 800 (P)	138	232212SX 300 G	131	32-0475V	103
2052000 (P)	80	2313016 800 (S)	138	232212SX 301 G	131	32-0477H	103
2052000 (S)	80	2313016 801 (P)	138	232222SX 302 G	131	32-0675	103
206005 (P)	88, 90	2313016 801 (S)	138	2323016 800 S	42	32-0775	103
206005 (S)	88, 90	2313025 X00 (P)	138	2323016 801 S	42	32-1375	101
206100 (P)	88, 90	2313025 X00 (S)	138	2323015 800 G	33, 130	32-5275	101
206100 (S)	88, 90	2313025 X01 (P)	138	2323015 801 G	33, 130	32-5375	101
207001 (P)	90	2313025 X01 (S)	138	2323015T 800 G	33, 130	32-5475	101
207001 (S)	90	2313025 X02 (P)	138	2323025 X00	130	32-5575	101
208005 (P)	84	2313025 X02 (S)	138	2323026 X00	130	32-5675	101
208005 (S)	84	2313025 X11 (P)	138	23230E5 X00 G	33, 130	32-5775	101
208006 (P)	84	2313025 X11 (S)	138	23230E5 X11 G	130	320100 (P)	100
208006 (S)	84	2313025 X12 (P)	138	23230E6 X00 S	42, 130	320100 (S)	100
208007 (P)	84	2313025 X12 (S)	138	23230X5 X00	130	320101 (P)	98
208007 (S)	84	2313026 X00 (P)	138	23230X6 X00	130	320101 (S)	98
208008 (P)	77	2313026 X00 (S)	138	23230X6 X00 S	42, 130	320101H (P)	98
208008 (S)	77	2313026 X01 (P)	138	23230X7 500	130	320101H (S)	98
2080147 (P)	84	2313026 X01 (S)	138	23230X7 511	130	320200 (P)	100
2080147 (S)	84	2313026 X02 (P)	138	23230XS X00 G	33, 130	320200 (S)	100
2080148 (P)	84	2313026 X02 (S)	138	23230XS X11 G	33, 130	320200B (P)	68



Product No.	Page	Product No.	Page	Product No.	Page	Product No.	Page
320200B (S)	68	33-076048	109	490214 (P)	68	510600 (S)	170
320201 (P)	98, 150, 170	33-07604H	109	490214 (S)	68	510600 C	52
320201 (S)	98, 150, 170	33-076051	109	490258 (P)	84	510600 G	31
320201CC BIR1	98	33-076061	109	490258 (S)	84	526001 (P)	169
320201H (P)	98	33-6B010 (P)	106	490357 T	91	526001 (S)	169
320201H (S)	98	33-6B010 (S)	106	490358 C	54	526011 (P)	169
320202 (P)	170	33-6B01W (P)	106	490359 G	32	526011 (S)	169
320202 (S)	170	33-6B01W (S)	106	490361 C	54	526101 (P)	169
320300H (P)	102	33-7B010 (P)	106	490366 C	54	526101 (S)	169
320300H (S)	102	33-7B010 (S)	106	490366 G	32	526111 (P)	169
320300V (P)	102	33-7B01W (S)	106	490368 C	54	526111 (S)	169
320300V (S)	102	33-7B01W(P)	106	490375 T	91	526201 (P)	168
320400H (P)	102	33600006 (P)	106, 150	490423 G	28	526201 (S)	168
320400H (S)	102	33600006 (S)	106, 150	490426 G	28	526211 (P)	168
320400V (P)	102	33600006 BI CC K	106	50-74201	170	526211 (S)	168
320400V (S)	102	33600007 K (P)	106	50-74211	170	526301 (P)	168
320405H (P)	102	33600007 K (S)	106	50-75201	170	526301 (S)	168
320405H (S)	102	3360000R (P)	113	50-75211	170	526311 (P)	168
320600 (P)	102	3360000R (S)	113	50-81732	159	526311 (S)	168
320600 (S)	102	33602012 (P)	108	50-817321	159	5293000 (P)	172
320700 (P)	102	33602012 (S)	108	50-81734	159	5293000 (S)	172
320700 (S)	102	33602013 K (P)	108	50-817341	159	5293000 G	31
321200 (P)	100	33602013 K (S)	108	50-81832	159	52930L0	172
321200 (S)	100	33602032 (P)	107	50-818321	159	5431500 (P)	163
321201 (P)	98	33602032 (S)	107	50-81834	159	5431500 (S)	163
321201 (S)	98	33602033 K (P)	107	50-818341	159	54315K0	163
321201D (P)	98	33602033 K (S)	107	500020 (P)	159	54315L0	163
321201D (S)	98	33602042 (P)	107	500020 (S)	159	54315R0 (P)	163
321350 (P)	100	33602042 (S)	107	5002201 (P)	170	54315R0 (S)	163
321350 (S)	100	33602043 K (P)	107	5002201 (S)	170	5431F00 (P)	163
322201 (P)	99	33602043 K (S)	107	5002211 (P)	170	5431F00 (S)	163
322201 (S)	99	33602052 (P)	108	5002211 (S)	170	5431FK0	163
322201 C	52	33602052 (S)	108	5003201 (P)	170	5431FLO	163
322201 G	29	33602053 K (P)	108	5003201 (S)	170	5431FR0 (P)	163
322301 (P)	99	33602053 K (S)	108	5003211 (P)	170	5431FR0 (S)	163
322301 (S)	99	33602062 (P)	108	5003211 (S)	170	5432500 (P)	166
322401 (P)	99	33602062 (S)	108	5004732 (P)	159	5432500 (S)	166
322401 (S)	99	33602063 K (P)	108	5004732 (S)	159	54325K0	166
322801 (P)	99	33602063 K (S)	108	5004732 G	31	54325L0	166
322801 (S)	99	33700006 (P)	106, 150	50047321 (P)	159	54325R0 (P)	166
324200 (P)	100	33700006 (S)	106, 150	50047321 (S)	159	54325R0 (S)	166
324200 (S)	100	33700007 K (P)	106	5004734 (P)	159	5433500 (P)	163
324201 (P)	98	33700007 K (S)	106	5004734 (S)	159	5433500 (S)	163
324201 (S)	98	3370000R (P)	113	5004734 G	31	54335R0 (P)	163
325200 (P)	100	3370000R (S)	113	50047341 (P)	159	54335R0 (S)	163
325200 (S)	100	3370000S (P)	106	50047341 (S)	159	5433F00 (P)	163
325300 (P)	100	3370000S (S)	106	5004832 (P)	159	5433F00 (S)	163
325300 (S)	100	33702022 (P)	108	5004832 (S)	159	5433FR0 (P)	163
325400 (P)	100	33702022 (S)	108	50048321 (P)	159	5433FR0 (S)	163
325400 (S)	100	33702023 K (P)	108	50048321 (S)	159	5434500 (P)	166
325500 (P)	100	33702023 K (S)	108	5004834 (P)	159	5434500 (S)	166
325500 (S)	100	33702042 (P)	107	5004834 (S)	159	54345R0 (P)	166
325600 (P)	100	33702042 (S)	107	50048341 (P)	159	54345R0 (S)	166
325600 (S)	100	33702043 K (P)	107	50048341 (S)	159	5441500 (P)	165
325700 (P)	100	33702043 K (S)	107	5008201 (P)	170	5441500 (S)	165
325700 (S)	100	337020B2 (P)	107	5008201 (S)	170	54415K0	165
32G2301	29	337020B2 (S)	107	5008211 (P)	170	54415L0	165
32G2401	29	337020C2 (P)	108	5008211 (S)	170	54415R0 (P)	165
32G2801	29	337020C2 (S)	108	5009201 (P)	170	54415R0 (S)	165
33-07340	109	337020E2 (P)	108	5009201 (S)	170	5441F00 (P)	165
33-076011	109	337020E2 (S)	108	5009211 (P)	170	5441F00 (S)	165
33-076021	109	490078 (P)	67	5009211 (S)	170	5441FK0	165
33-076025	109	490078 (S)	67	510600 (P)	91	5441FLO	165
33-076028	109	490079 (P)	67	510600 (S)	170	5441FR0 (P)	165
33-07603H	109	490079 (S)	67	510600 (S)	91	5441FR0 (S)	165



Product No.	Page	Product No.	Page	Product No.	Page	Product No.	Page
5442500 (P)	167	54625X0	41	600750T (S)	178	640550T (P)	182
5442500 (S)	167	5471500 (P)	164	600850T (P)	178	640550T (S)	182
54425K0	167	5471500 (S)	164	600850T (S)	178	640750ET (P)	184
54425L0	167	5471500 G	31	600950T (P)	178	640750ET (S)	184
54425R0 (P)	167	54715K0	164	600950T (S)	178	640750GT (P)	184
54425R0 (S)	167	54715L0	164	601150T (P)	178	640750GT (S)	184
5443500 (P)	165	54715R0 (P)	164	601150T (S)	178	640950T (P)	184
5443500 (S)	165	54715R0 (S)	164	601150T KIT (P)	177	640950T (S)	184
54435R0 (P)	165	54715R0 G	31	601150T KIT (S)	177	640952T (P)	184
54435R0 (S)	165	54715X0	41	601250T (P)	178	640952T (S)	184
5443F00 (P)	165	5471F00 (P)	164	601250T (S)	178	641050T (P)	184
5443F00 (S)	165	5471F00 (S)	164	601251T (P)	178	641050T (S)	184
5443FR0 (P)	165	5471F00 G	31	601251T (S)	178	641051T (P)	184
5443FR0 (S)	165	5471FK0	164	601450T (P)	178	641051T (S)	184
5444500 (P)	167	5471FL0	164	601450T (S)	178	641200 C	52, 55
5444500 (S)	167	5471FR0 (P)	164	601450T KIT (P)	177	641200D C	55
54445R0 (P)	167	5471FR0 (S)	164	601450T KIT (S)	177	641201 C	52, 55
54445R0 (S)	167	5471FR0 G	31	601452T (P)	178	641201D C	55
5451500 (P)	162	5471FX0	41	601452T (S)	178	652150T 011 (P)	189
5451500 (S)	162	5472500 (P)	167	60300 CUT W 219	193	652150T 011 (S)	189
5451500 G	31	5472500 (S)	167	607155XT (P)	180	652150T 012 (P)	189
54515K0	162	5472500 G	31	607155XT (S)	180	652150T 012 (S)	189
54515L0	162	54725K0	167	607255XT (P)	180	652150T 021 (P)	189
54515R0 (P)	162	54725L0	167	607255XT (S)	180	652150T 021 (S)	189
54515R0 (S)	162	54725R0 (P)	167	607355XT (P)	180	6522560 G -121-XX	32
54515R0 G	31	54725R0 (S)	167	607355XT (S)	180	6522560 G -122-XX	32
54515X0	41	54725R0 G	31	607455XT (P)	180	6522560T 121 (P)	191
5451F00 (P)	162	54725X0	41	607455XT (S)	180	6522560T 121 (S)	191
5451F00 (S)	162	5481500 (P)	164	607555XT (P)	180	6522560T 122 (P)	191
5451F00 G	31	5481500 (S)	164	607555XT (S)	180	6522560T 122 (S)	191
5451FK0	162	54815K0	164	60810 XXX C	54	6522560T 132 (P)	191
5451FL0	162	54815L0	164	60810D XXX C	54	6522560T 132 (S)	191
5451FR0 (P)	162	54815R0 (P)	164	60820 XXX C	54	6522560T 133 (P)	191
5451FR0 (S)	162	54815R0 (S)	164	60820D XXX C	54	6522560T 133 (S)	191
5451FR0 G	31	54815X0	41	6210555 G XX	32	6522560T 134 (P)	191
5451FX0	41	5481F00 (P)	164	6210555T (P)	186	6522560T 134 (S)	191
5452500 (P)	165	5481F00 (S)	164	6210555T (S)	186	6522560T 221 (P)	191
5452500 (S)	165	5481FK0	164	6211555 G XX	32	6522560T 221 (S)	191
5452500 G	31	5481FL0	164	6211555T (P)	186	652650T 101 (P)	189
54525K0	165	5481FR0 (P)	164	6211555T (S)	186	652650T 101 (S)	189
54525L0	165	5481FR0 (S)	164	6212555 G XX	32	652650T 102 (P)	189
54525R0 (P)	165	5481FX0	41	6212555T (P)	186	652650T 102 (S)	189
54525R0 (S)	165	5482500 (P)	167	6212555T (S)	186	652650T 111 (P)	189
54525R0 G	31	5482500 (S)	167	6221554T (P)	187	652650T 111 (S)	189
54525X0	41	54825K0	167	6221554T (S)	187	652650T 131 (P)	189
5461500 (P)	162	54825L0	167	6221557T (P)	187	652650T 131 (S)	189
5461500 (S)	162	54825R0 (P)	167	6221557T (S)	187	652650T 132 (P)	189
54615K0	162	54825R0 (S)	167	6261557T (P)	187	652650T 132 (S)	189
54615L0	162	54825X0	41	6261557T (S)	187	652650T 133 (P)	189
54615R0 (P)	162	600250T (P)	178	6280550 G	32	652650T 133 (S)	189
54615R0 (S)	162	600250T (S)	178	6280550 G -XX	32	66391 (P)	170, 180, 186
54615X0	41	600350T (P)	178	6282550 G	32	66391 (S)	170, 180, 186
5461F00 (P)	162	600350T (S)	178	6282550 G -XX	32	66418 (P)	170
5461F00 (S)	162	600350T KIT (P)	177	640155CT (P)	184	66418 (S)	170
5461FK0	162	600350T KIT (S)	177	640155CT (S)	184	90-0001	202
5461FL0	162	600450T (P)	178	640155T (P)	184	90-0028	193
5461FR0 (P)	162	600450T (S)	178	640155T (S)	184	94-0020	171
5461FR0 (S)	162	600550T (P)	178	640250T (P)	182	94-0029	152
5461FX0	41	600550T (S)	178	640250T (S)	182	94-0030	152
5462500 (P)	166	600650269 G -XX	32	640251T (P)	182	94-0034	95
5462500 (S)	166	600650T (P)	178	640251T (S)	182	94-0035	95
54625K0	166	600650T (S)	178	640550AT (P)	182	94-0036	95
54625L0	166	600650T KIT (P)	177	640550AT (S)	182	94-0051	95
54625R0 (P)	166	600650T KIT (S)	177	640550FT (P)	182	94-0052	171
54625R0 (S)	166	600750T (P)	178	640550FT (S)	182	94-0058-MED	151

Product No.	Page	Product No.	Page	Product No.	Page	Product No.	Page
94-0059	151	960358 (S)	170	CP-063220	134, 136	CP-160601	183
94-0061	95	CARD 1 X XX	193	CP-064231	201	CP-160611	183
94-0067	95	CARD 2 X XX	193	CP-064490	91	CP-160661-50	136
94-0098	95	CARD 6 X XX	193	CP-064701	201	CP-160661-55	136
94-0174-XX	71, 72, 201	CARD KS XX 8E	193	CP-070011	73	CP-160691	170
94-0188-XX	73	CARD XX 56 XX	193	CP-070111	183	CP-170011	200
94-0199	171	CARD XX 66 XX	193	CP-070131	183	CP-170021	200, 201
94-0203	134	CB-CODE-BIA	193	CP-070141	183	CP-170031	200, 201
94-0204	193	CB-CODE-BOK	193	CP-070161	183	CP-170041	200, 201
94-0207	134, 199	CN-DIES	192	CP-070171	183	CP-170051	200
94-0208	134	CP-010103-040	201	CP-070181	183	CP-170061	200
94-0210	152	CP-010203-030	201	CP-070201	183	CP-170250	171
94-0212	152	CP-010203-050	71, 91, 201	CP-070441	183	CP-170271	200
94-0213	173	CP-010234-320	152	CP-070451	73	CP-170430	200
94-0221	134	CP-010235-120-XX	152	CP-070481	183	CP-170440	200
94-0222	134	CP-010503-040	91, 201	CP-070501	183	CP-170481	200
94-0223	134	CP-011011-020	71, 72, 201	CP-070691	152	CP-170730-5	134, 200
94-0227-XX	71, 72, 201	CP-011013-020	71, 72, 140, 201	CP-070701	152	CP-170730-6	134, 200
94-0239	34	CP-011013-040	140, 201	CP-070711	153	CP-170930	35, 47, 56
94-0249	56	CP-011511-000	171	CP-070721	153	CP-171011	159
94-0255-XX	201	CP-011751	152	CP-070731	153	CP-171021	159
94-0256-XX	201	CP-011753	152	CP-070741	153	CP-171031	159
94-0261	193	CP-011754	152	CP-084571	71, 72, 201	CP-180021	73
94-0269	193	CP-011757	152	CP-084671	71, 72, 201	CP-180031	72
94-0271	34	CP-011762	152	CP-100111	140	CP-180041	73
94-0272	95	CP-011763	152	CP-100761	140	CP-180061	153
94-0283	131	CP-011764	152	CP-100771-Z00	28	CP-200720	171
94-0285	134	CP-011767	152	CP-100771-Z01	28	CP-200751-10	132, 136
94-0287	130	CP-012409-030	140	CP-100771-Z02	28	CP-200751-15	132, 136
94-0288	130	CP-012411-030	140	CP-100771-Z20	28	CP-200751-20	132, 136
94-0289	130	CP-012411-040	140	CP-100771-Z34	28	CP-200751-25	132, 136
94-0290	35	CP-012917-000	72	CP-100781-Z00	28	CP-200751-30	132, 136
94-0291	35	CP-020010	72	CP-100781-Z01	28	CP-200751-40	132
94-0292	35	CP-020020	91	CP-100781-Z02	28	CP-200751-45	132
94-0294	35	CP-020031	140	CP-100781-Z20	28	CP-200751-50	132
94-0295	35	CP-020040	91	CP-100781-Z34	28	CP-200751-55	132
94-0296	35	CP-020100	91	CP-130101	171	CP-200751-60	132
94-0298	199	CP-020240	140	CP-130510	171	CP-200751-65	132
94-0304-MOP	45	CP-021011	71	CP-142043	171	CP-200751-70	132
94-0304-MBP	45	CP-021031	91	CP-142543	171	CP-200751-75	132
94-0305-MOP	45	CP-021121	72	CP-144110	171	CP-200751-80	132
94-0305-MBP	45	CP-021130	91	CP-144120	171	CP-200751-85	132
94-0306	34	CP-021370	91	CP-144130	171	CP-200751-90	132
94-0307	34	CP-021400	140	CP-144140	171	CP-200761-05	132
94-0309	193	CP-021490	140	CP-144150	171	CP-200761-10	132
94-0312	44	CP-021651	91	CP-144160	171	CP-200761-15	132
95-000200	203	CP-022030	171	CP-150082	189	CP-200761-20	132
95-001100	203	CP-030001	140, 200	CP-150102	189	CP-200761-25	132
95-100070	203	CP-030017	200	CP-150142	189	CP-200761-30	132
95-100400	203	CP-030018	71, 72, 200	CP-150152	189	CP-200761-40	132
95-210100-MED3	203	CP-030024	140	CP-160051	183	CP-200761-45	132
95-210100-UNIV	203	CP-030025	140	CP-160061	183	CP-200761-50	132
95-210100-XX	203	CP-030042	200	CP-160071	183	CP-200761-55	132
95-210130-MED3	203	CP-030430	171	CP-160081	183	CP-200761-60	132
95-210130-UNIV	203	CP-030590	200	CP-160091	183	CP-200761-65	132
95-210130-XX	203	CP-030670	91	CP-160101	183	CP-200761-70	132
95-M11000	203	CP-030860	136, 140	CP-160111	183	CP-200761-75	132
95-M23000	203	CP-030910	200	CP-160121	183	CP-200761-80	132
95-M34000	203	CP-031030	140	CP-160180	73	CP-200761-85	132
95-M45000	203	CP-031170	201	CP-160271	183	CP-200761-90	132
95-M55000	203	CP-031480	201	CP-160301	183	CP-200771-05	133, 136
95-M56000	203	CP-041200	91	CP-160541	183	CP-200771-10	133, 136
960357 (P)	170	CP-050120	71	CP-160551	183	CP-200771-15	133, 136
960357 (S)	170	CP-060106	136	CP-160571	183	CP-200771-20	133, 136
960358 (P)	170	CP-060203	72	CP-160591	183	CP-200771-25	133, 136

Product No.	Page	Product No.	Page	Product No.	Page	Product No.	Page
CP-200801-00	133	CP-282430	199	CT-F37	92	CT-Y71	94
CP-200801-02	133	CP-282451	199	CT-F38	92	CT-Y72	94
CP-200801-04	133	CP-282460	201	CT-F40	92	CT-Y73	94
CP-200801-06	133	CP-282470	201	CT-F42	153	CT-Y74	94
CP-200801-08	133	CP-282500	199	CT-F43	153	CT-Y75	94
CP-200801-0A	133	CP-282530	199	CT-F44	153	CT-Y76	140
CP-200801-12	136	CP-282540	199	CT-H00	181	CT-Y77	94
CP-200801-14	136	CP-285901	135, 140	CT-H07	181	CT-Y78	94
CP-200801-16	136	CP-285921-500	135, 140	CT-H09	181	CT-Y97	94
CP-200801-18	136	CP-285931	135, 140	CT-H14	181	CT-Z00	69
CP-200801-1A	136	CP-285951-500	135, 140	CT-H15	181	CT-Z01	69
CP-200801-22	133	CP-285961	135, 140	CT-H16	181	CT-Z02	69
CP-200801-24	133	CP-285981-500	135, 140	CT-H17	181	CT-Z04	69
CP-200801-26	133	CP-285991	135, 140	CT-H19	181	CT-Z05	69
CP-200801-28	133	CP-286011-500	135, 140	CT-H20	181	CT-Z06	69
CP-200801-2A	133	CP-286021	135	CT-H27	181	CT-Z07	69
CP-200801-44	133	CP-286041-500	135, 140	CT-H30	181	CT-Z08	69
CP-200801-46	133	CP-286051	135	CT-H32	181	CT-Z09	69
CP-200801-48	133	CP-286071-500	135	CT-J01	182	CT-Z16	69
CP-200801-4A	133	CP-286131	193	CT-J05	182	CT-Z17	69
CP-200801-66	133	CP-286180	35	CT-J07	182	CT-Z18	69
CP-200801-68	133	CP-286350	199	CT-J08	182	CT-Z19	69
CP-200801-6A	133	CP-286531-25-EL	196	CT-J11	182	CT-Z20	69
CP-200801-88	133	CP-287260	35, 47, 56	CT-J12	182	CT-Z21	69
CP-200801-8A	133	CP-301290	35	CT-J13	182	CT-Z22	70
CP-200801-AA	133	CT-A00	180	CT-J14	182	CT-Z26	140
CP-200830	136	CT-A01	180	CT-J15	182	CT-Z29	140
CP-200851-10	133	CT-A02	180	CT-J18	182	CT-Z34	70
CP-200851-15	133	CT-A03	180	CT-J22	182	CT-Z45	70
CP-200851-20	133	CT-A04	180	CT-J27	182	CT-Z47	70
CP-200851-25	133	CT-A05	180	CT-J28	182	CT-Z48	70
CP-200851-30	133	CT-A06	180	CT-J29	182	CT-Z50	134
CP-200851-45	133	CT-A07	180	CT-V00	92	CT-Z50	140
CP-200851-55	133	CT-A08	180	CT-V01	92	CT-Z51	134
CP-200851-60	133	CT-A09	180	CT-V02	92	CT-Z51	140
CP-200851-65	133	CT-A11	180	CT-V03	92	CT-Z55	70
CP-200851-70	133	CT-A12	180	CT-V19	92	CT-Z56	70
CP-200851-75	133	CT-A13	180	CT-V35	92	CT-Z57	70
CP-200851-80	133	CT-A14	180	CT-V39	92	CT-Z58	70
CP-200851-85	133	CT-A15	180	CT-V40	92	CT-Z59	70
CP-200851-90	133	CT-A16	180	CT-Y02	73	CT-Z61	70
CP-220071	134, 140	CT-A19	180	CT-Y08	73, 92	CT-Z69	70
CP-220090	134, 140	CT-C02	181	CT-Y24	93	CT-Z70	70
CP-220120	140	CT-C04	181	CT-Y27	93	CT-Z84	70
CP-220201	140	CT-C05	181	CT-Y28	93	CT-Z87	70
CP-230081	140	CT-C08	181	CT-Y29	93	CT-Z88	136
CP-230091	140	CT-C09	181	CT-Y31	93	CT-Z88	140
CP-240761-500	135	CT-C11	181	CT-Y32	73	CT-Z98	130
CP-240771-5P	134	CT-D00	181	CT-Y35	93	CT-Z98	140
CP-240771-6P	134	CT-D01	181	CT-Y37	93	CT-Z99	70
CP-250010	153	CT-D02	181	CT-Y46	93	CT-ZA2	140
CP-250020	153	CT-D03	181	CT-Y47	93	DE-CODE-KEY	192
CP-250030	171	CT-D04	181	CT-Y49	93	DE-CODE-LOK	192
CP-250040	171	CT-D05	181	CT-Y52	93	E23230E5 X11 G	33
CP-250140	171	CT-D06	181	CT-Y53	93	EA-100088	35
CP-270511	189	CT-D07	181	CT-Y54	93	EA-100107	34
CP-270521	189	CT-D08	181	CT-Y55	93	EA-100108	29
CP-270531	189	CT-D09	181	CT-Y57	93	EA-100109	35
CP-270541	189	CT-D11	181	CT-Y58	94	EA-100110	193
CP-270551	189	CT-D12	181	CT-Y60	153	EA-100111	193
CP-270561	189	CT-D15	181	CT-Y61	153	EA-100117	110
CP-280261	140	CT-D19	181	CT-Y67	94	EA-100121	56
CP-280271	42, 171	CT-F34	92	CT-Y68	94	EA-100125	35
CP-280330	134	CT-F35	92	CT-Y69	94	EA-100126	47
CP-280620	153	CT-F36	92	CT-Y70	94	EA-100138	35

Product No.	Page	Product No.	Page	Product No.	Page	Product No.	Page
EA-100142	47	.KW5011	198	KYB 74563P XX 99	195	KYC 77793K XXX 99	196
EA-100145	56	.KW5012	198	KYB 745640 XX 99	197	KYC 77793P XXX 99	195
EA-100148	110	.KW5401	47	KYB 746600 XX 99	197	KYC 777940 XXX 99	197
EA-100149	110	.KW5401	130	KYB 74663J XX 99	196	KYC A50000 AXX 00	192
EA-100154	110	.KW5401	198	KYB 74663K XX 99	196	KYC A60000 AXX 00	192
EA-100156	34	.KW9003	198	KYB 74663P XX 99	195	PK-KYLUBE-02	35
EA-100158	35	KEB 47600C	45	KYB 746640 XX 99	197	PK-KYLUBE-11	35
EA-100159	56	KEB 48600C	45	KYB 776600 XX 99	197	PX-KYLUB203	199
EA-100160	47	KEC 42602B	56	KYB 77663F NM XX	195	PX-KYLUBL-50	199
EA-100167	56	KEC 42603B	56	KYB 77663H NM XX	196	RE-KEY	192
EA-100168	47	KEC 4260CR	56	KYB 77663N NM XX	196	RE-KEY-MK	192
EA-100173	34, 193	KEC 426P2B	56	KYB 77663P XX 99	195	ST-LASER	192
EA-100174	34, 193	KEC 426P3B	56	KYB 776900 XXX 99	197	SW-500001	203
EA-100177	34	KEC 47X002	45	KYB 77693P XXX 99	195	SW-500101-1	46
EA-100178	34	KEC 47X003	45	KYB 776940 XXX 99	197	SW-500101-3	46
EA-100179	47	KEC 47X013	45	KYB 777600 XX 99	197	SW-500101-5	46
EA-100180	47	KEC 47X023	45	KYB 77763P XX 99	195	SW-500121-0	44
EA-100181	47	KEC 47XB03	43	KYB 777900 XXX 99	197	SW-500121-1	44
EA-100182	47	KEC 47XP02	45	KYB 77793P XXX 99	195	SW-500121-1R	44
EA-100192	25	KEC 47XP03	45	KYB 777940 XXX 99	197	SW-500130	21
EA-100197-016	24	KEC 48X002	45	KYB A50000-AXX00	194	SW-500301-1	22
EA-100197-032	24	KEC 48X003	45	KYB A60000-AXX00	194	SW-500301-1R	22
EA-100197-064	24	KEC 48X013	45	KYB XX5400 XX 99	194	SW-500301-2	21
EA-100206	26	KEC 48X023	45	KYB XX6605	153	SW-500301-3	21
EA-100207	26	KEC 48XB03	43	KYB XX6611	98	SW-500301-4	21
EA-100208	26	KEC 48XP02	45	KYB XX6620 XX 05	99	SW-600001	203
EA-100221	26	KEC 48XP03	45	KYB XX6X31	99	SW-600201	203
EA-100222	44	KEC 49X002	45	KYB XX7X11	98	SW-600401	203
EA-100224	44	KEC 49X003	45	KYB XX7X31	99	SW-600801	57
EA-100230	44	KEC 49X013	45	KYC 326900 XXX 99	192	SW-600801-6	46
EA-200058	35	KEC 49XB03	43	KYC 326900 XXX XX	192	SW-600801-6R	46
EA-250050	35	KEC 49XP02	45	KYC 346600 XX XX	192	SW-600801-6R	57
EA-250059	35	KEC 49XP03	45	KYC 355600 XX 99	192, 197	SW-600901	22
EA-300069-01-EL	195	KM KYB 776640 XX 99	197	KYC 35563J XX 99	196	SW-600901-1	22
EA-300070-01-EL	195	KM KYB 777640 XX 99	197	KYC 35563K XX 99	196	SW-600901-1R	22
EA-300086-01-EL	196	KM-SHARP-CUT	192, 203	KYC 35563P XX 99	195	SW-600901-R	22
EA-300087-01-EL	196	KYB 105400 XX 00	194	KYC 355640 XX 99	197	SW-601101	22
EA-300088-01-EL	196	KYB 10X600 XX XX	194	KYC 356600 XX 99	197	SW-601101-R	22
EA-300089-01-EL	196	KYB 10X605 XX	194	KYC 35663J XX 99	196	SW500101-1	57
EA-350084	45	KYB 115400 S6 43	194	KYC 35663K XX 99	196	SW500101-3	57
EA-500054-M0P	45	KYB 115400 XX 00	194	KYC 35663P XX 99	195	SW500101-5	57
EA-500054-MBP	45	KYB 12X600 XX 99	194	KYC 356640 XX 99	197	SW600801-6	57
EN-150002-XXX (Op Code)	32	KYB 17X600 XX 99	194	KYC 745600 XX 99	197	T-7155	199
EN-150003-XXX (Op Code)	32	KYB 32X600 XX 99	194	KYC 74563J XX 99	196	TP-F10-2W (.060")	135
EV-8501D	31, 33	KYB 32X900 XX 99	194	KYC 74563K XX 99	196	TP-F10-3M	199
EV-8501S	31, 33	KYB 33X600 XX 99	194	KYC 74563P XX 99	195	TP-F10-3W (.090")	135
K-1001	199	KYB 34X600 XX 99	194	KYC 745640 XX 99	197	TP-F10-4T (.180")	135
K-1002	199	KYB 355600 XX 99	197	KYC 746600 XX 99	197	TP-F10-4W-6T (.120")	135
K-1003	199	KYB 35563J XX 99	196	KYC 74663J XX 99	196	TP-F10-5T (.150")	135
K-1005	199	KYB 35563K XX 99	196	KYC 74663K XX 99	196	TP-F10-XT	199
K-1006	199	KYB 35563P XX 99	195	KYC 74663P XX 99	195	TP-F10-XW	199
K-1099	201	KYB 355640 XX 99	197	KYC 746640 XX 99	197	TP-F10-XX	199
K-4001	198	KYB 356600 XX 99	197	KYC 776600 XX 99	197	TP-F15-XB	199
K-4002	198	KYB 35663J XX 99	196	KYC 77663P XX 99	195	TP-F15-XT	199
K-4003	198	KYB 35663K XX 99	196	KYC 776640 XX 99	197	TP-F50-XW	199
K-4004	198	KYB 35663P XX 99	195	KYC 776900 XXX 99	197	TP-F50-XX	199
K-4006	198	KYB 356640 XX 99	197	KYC 77693K XXX 99	196	TP-F53-XX	199
K-6001	199	KYB 38X600 XX 99	194	KYC 77693P XXX 99	195	TP-F60-XX	199
K-6002	199	KYB 38X900 XX 99	194	KYC 77693P XXX 99	196	TP-F90-XX	199
K-9001	198	KYB 745600 XX 99	197	KYC 776940 XXX 99	197	TP-H10-9W (.135")	135
.KJ1501	198	KYB 74563F NM XX	195	KYC 777600 XX 99	197	TP-K40-XX-BH	199
.KW5005	198	KYB 74563H NM XX	196	KYC 77763P XX 99	195	TP-K40-XX-TH	199
.KW5006	198	KYB 74563J XX 99	196	KYC 777640 XX 99	197	TP-K42-Z9	199
.KW5007	198	KYB 74563K XX 99	196	KYC 777900 XXX 99	197	TP-K43-XX-BH	199
.KW5010	198	KYB 74563N NM XX	196	KYC 77793J XXX 99	196		

## Finishes Available - Commercial & Industrial Locks



**05**  
**(US03)**  
**Bright Brass**

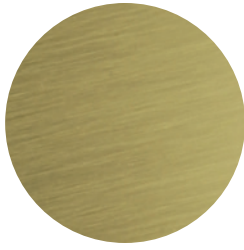

**06**  
**(US04)**  
**Satin Brass**



**09**  
**(US5)**  
**Antique Brass**



**10**  
**Satin Brass**  
**Blackened**

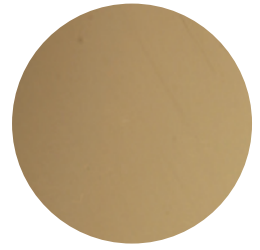

**11**  
**(US9)**  
**Bright Bronze**



**12**  
**(US10)**  
**Satin Bronze**



**13**  
**(US10B)**  
**Dark Bronze/  
Oil Rubbed**

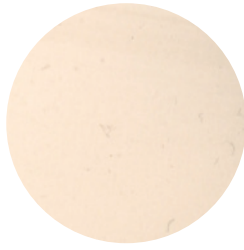

**18**  
**(US14)**  
**Bright Nickel**



**19**  
**(US15)**  
**Satin Nickel**

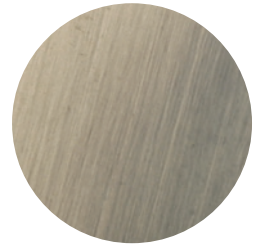

**20**  
**(US15A)**  
**Antique Nickel**



**22**  
**(US19)**  
**Flat Black**

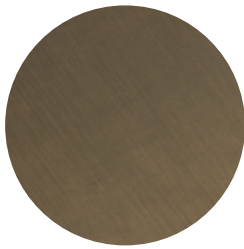

**24**  
**(US20A)**  
**Dark Bronze/  
Clear Coat**

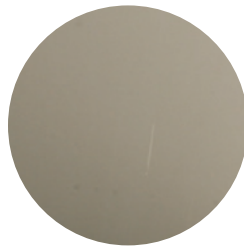

**25**  
**(US26)**  
**Bright Chrome**



**26**  
**(US26D)**  
**Satin Chrome**

*Note: Product appearance may differ from this chart as a result of the differences in plated versus printed materials.*







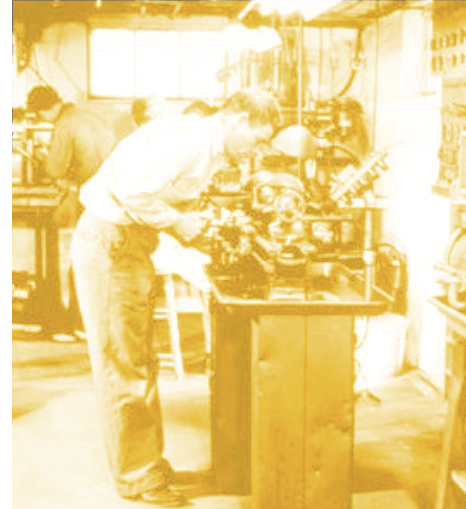

# medeco®

---

## ASSA ABLOY

ASSA ABLOY is the global leader in door opening solutions, dedicated to satisfying end-user needs for security, safety and convenience

### MEDECO USA

3625 Alleghany Drive  
Salem, Virginia 24153-0330  
Customer Service  
**1.877.633.3261**

### MEDECO CANADA

160 Four Valley Drive  
Vaughan, ON L4K 4T9 CANADA  
Customer Service  
**1.888.633.3264**

    @MEDECOLOCKS

### MEDECO.COM

Medeco is a brand associated with ASSA ABLOY High Security Group, Inc., an ASSA ABLOY Group company. Copyright © 2019, ASSA ABLOY High Security Group, Inc. All rights reserved. Reproduction in whole or in part without the express written permission of ASSA ABLOY High Security Group, Inc. is prohibited. LT-922119 REV 13