

**Notes:**

1. Do not scale drawing.
2. Right hand shown.
3. Suitable reinforcing by others.
4. Maximum degree of opening 180°, trim permitting.
5. All dimensions are in inches.  
Metric = 25.4 x inch.
6. Minimum two M190 Intermediate Pivots required. Add more for taller doors.
7. Place 1st Intermediate Pivot as close as possible to top of door.
8. Place other Intermediate Pivot equidistant.

**547 Pivot Set  
 3/4" Offset  
 For Use With Arch Top Doors  
 Or Overhead Concealed Closers**

**RIXSON<sup>®</sup>**  
**ASSA ABLOY**

www.rixson.com

TEMPLATE NUMBER	REV	DATE
<b>IS-547</b>	<b>3</b>	<b>05-24</b>

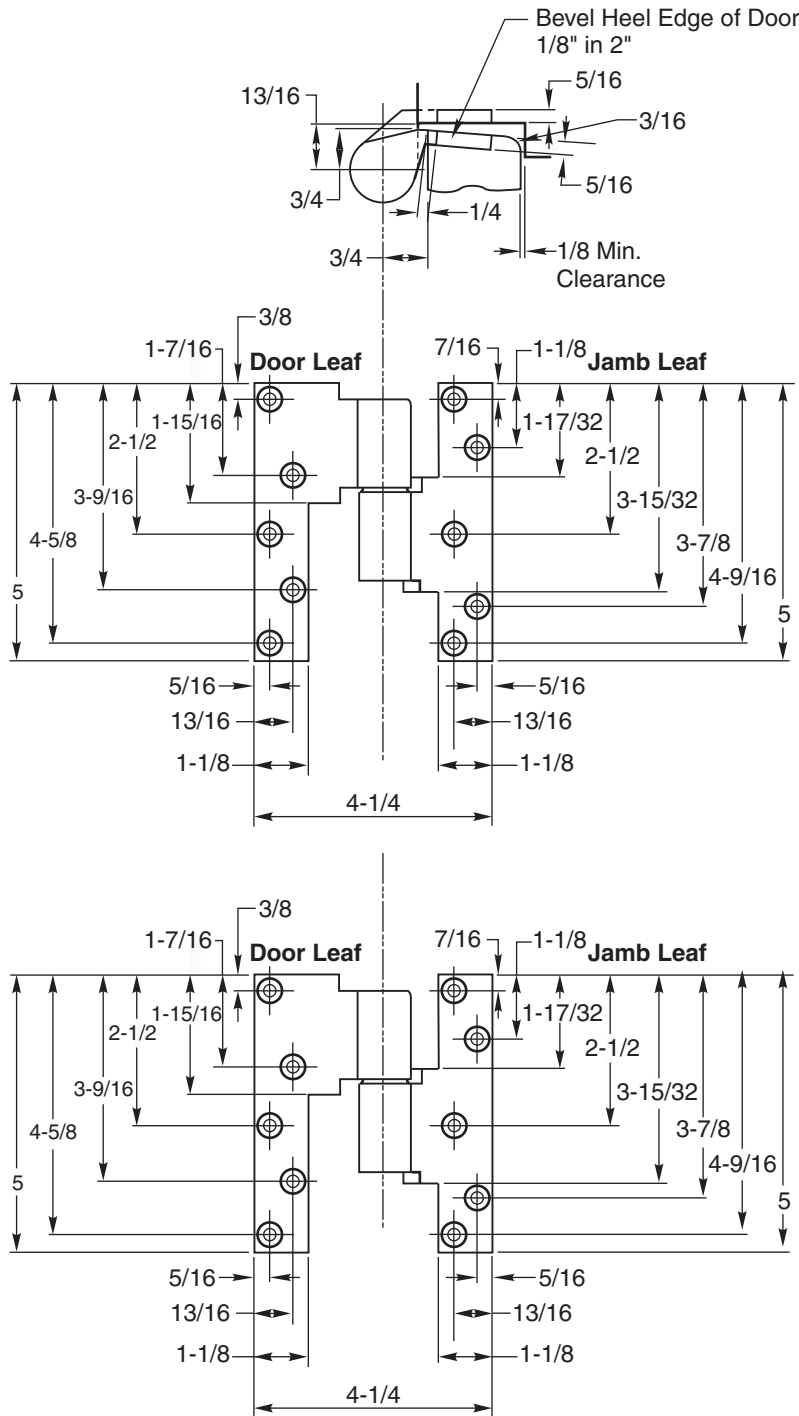

**Notes:**

1. Do not scale drawing.
2. Right hand shown.
3. Suitable reinforcing by others.
4. Maximum degree of opening 180°, trim permitting.
5. All dimensions are in inches.  
Metric = 25.4 x inch.
6. Minimum two M190 Intermediate Pivots required. Add more for taller doors.
7. Place 1st Intermediate Pivot as close as possible to top of door.
8. Place other Intermediate Pivot equidistant.

**547 Pivot Set  
 3/4" Offset  
 For Use With Arch Top Doors  
 Or Overhead Concealed Closers**

**RIXSON<sup>®</sup>**  
**ASSA ABLOY**

www.rixon.com

TEMPLATE NUMBER	REV	DATE
<b>IS-547</b>	<b>3</b>	<b>05-24</b>

# 547 Pivot Set

1.  Mortise door & frame for pivots & bottom arm per template on reverse side.

2.  Affix jamb portion of first intermediate pivot.

3.  Drop plumb line to find position of bottom pivot. (See diagram)

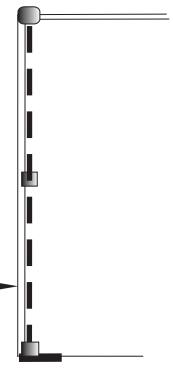

4. Place bottom pivot & verify plumb bob is 13/16" from jamb.

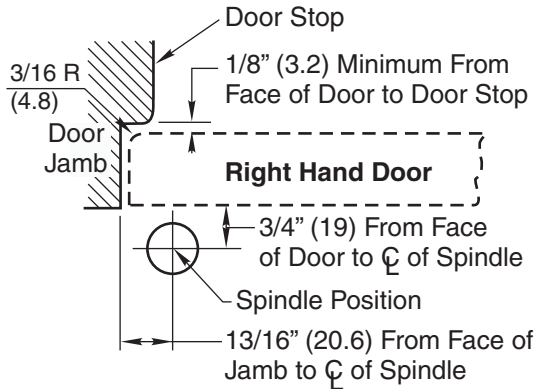

5. Level bottom plate. Attach to floor.

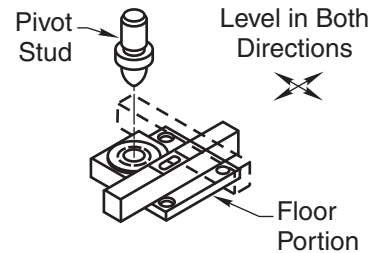

6. Install arm in under side of door.

7. Install door portion of intermediate pivots.

8. Put door on bottom pivot. Do not tighten arm screw.

9. Install frame portion of first intermediate pivot.

10. Install frame portion of second intermediate pivot.

**547 Pivot Set**  
**3/4" Offset**  
**For Use With Arch Top Doors**  
**Or Overhead Concealed Closers**

**RIXSON**  
**ASSA ABLOY**

www.rixon.com

TEMPLATE NUMBER	REV	DATE
IS-547	3	05-24



11. Remove hex caps from both intermediate pivots.



12. Turn adjusting screw clockwise, on both side jamb pivots. This will raise the door on the bottom spindle.

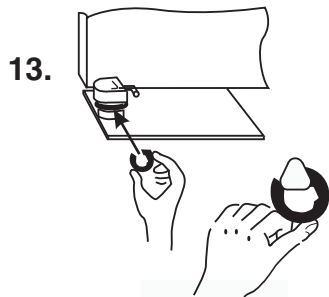

13. Using shims furnished with bottom arm, fill gap between arm and base.

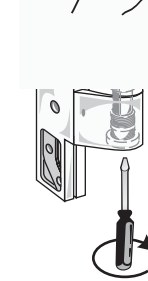

14. Turn stud screw counterclockwise until door rests on shims. Do this for both intermediate pivots.



15. Tighten arm screw on spindle. Open and close door several times re-tighten arm screw.

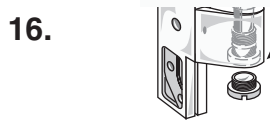

16. Replace hex cap.



17. Put decorative arm cap on bottom arm.

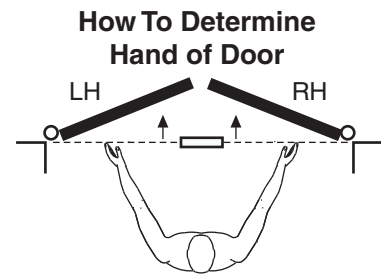

Face a door swinging open away from you. If it opens to the right, it is right hand. If it opens to the left, it is left hand.

**547 Pivot Set**  
**3/4" Offset**  
**For Use With Arch Top Doors**  
**Or Overhead Concealed Closers**

**RIXSON**  
**ASSA ABLOY**

www.rixon.com

TEMPLATE NUMBER	REV	DATE
IS-547	3	05-24