

- NOTES:**
- Dimensions shown in inches / (mm) unless specified otherwise.
 - Electrical requirements:
 - Power input of 120VAC, 5Amp minimum
 - Accessories circuit for activation to operator and low voltage
 - For initial set up, doors must be un-latched and free to move
 - For additional installation instructions, see instruction sheet 80-9360-1040-020. Visit www.NortonRixson.com
 - Refer to page 2 for proper handling of product

**6051 Series Template
 for 36"-48" wide door shown with up to 5" Butt Hinges
 Reveal of 1/8" to 3" Maximum Opening of 110°**

Approved 2023-07-12

Page 1



ASSA ABLOY

TEMPLATE NUMBER	REV	DATE
7360-1048	2	05/23

Single Push Side

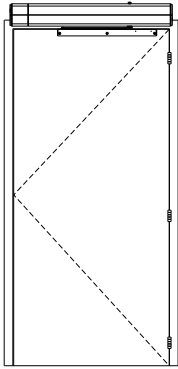

NOTE:

- All illustrations on this page shown with 36" (914mm) wide doors

Left Hand Door
(view from below)

Right Hand Door
(view from below)

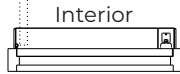
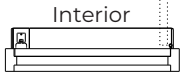

Double Door Push Side

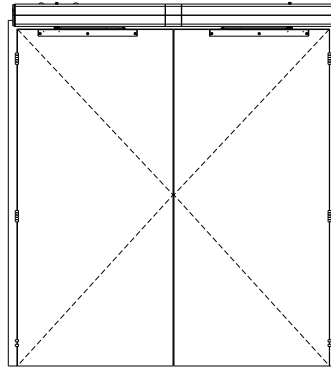

Right Hand Door
(view from below)

Left Hand Door
(view from below)

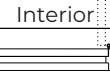

Double Door Double Egress Left Hand

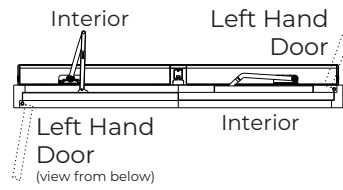
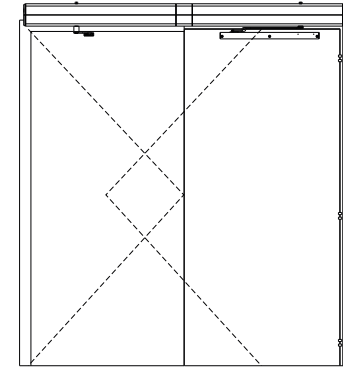

Single Pull Side

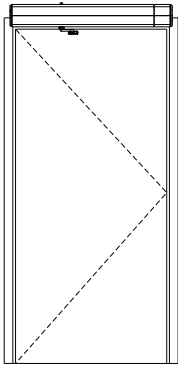

Exterior
Right Hand Door
(view from below)

Exterior
Left Hand Door
(view from below)

Double Door Pull Side

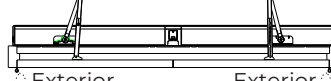
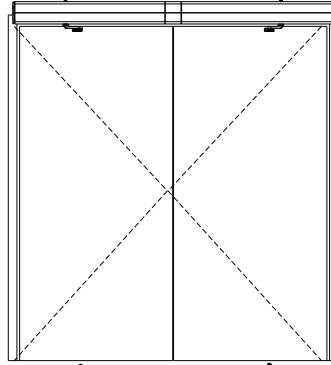

Left Hand Door
(view from below)

Right Hand Door
(view from below)

Double Door Double Egress Right Hand

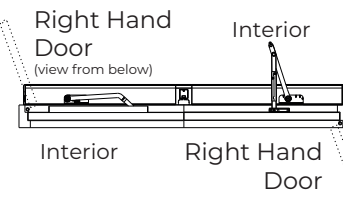
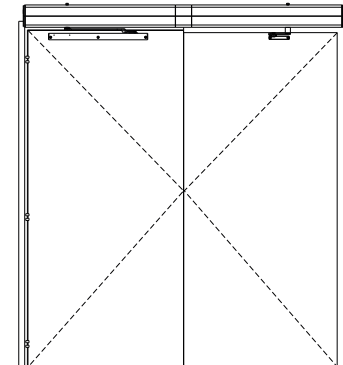

6051 Series Template
for 36"-48" wide door shown with up to 5" Butt Hinges
Reveal of 1/8" to 3" Maximum Opening of 110°

Approved 2023-07-12

Page 2



ASSA ABLOY

TEMPLATE NUMBER

7360-1048

REV DATE

2 05/23

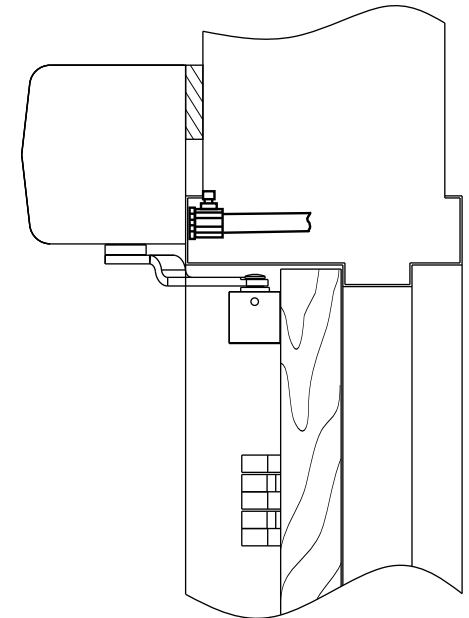
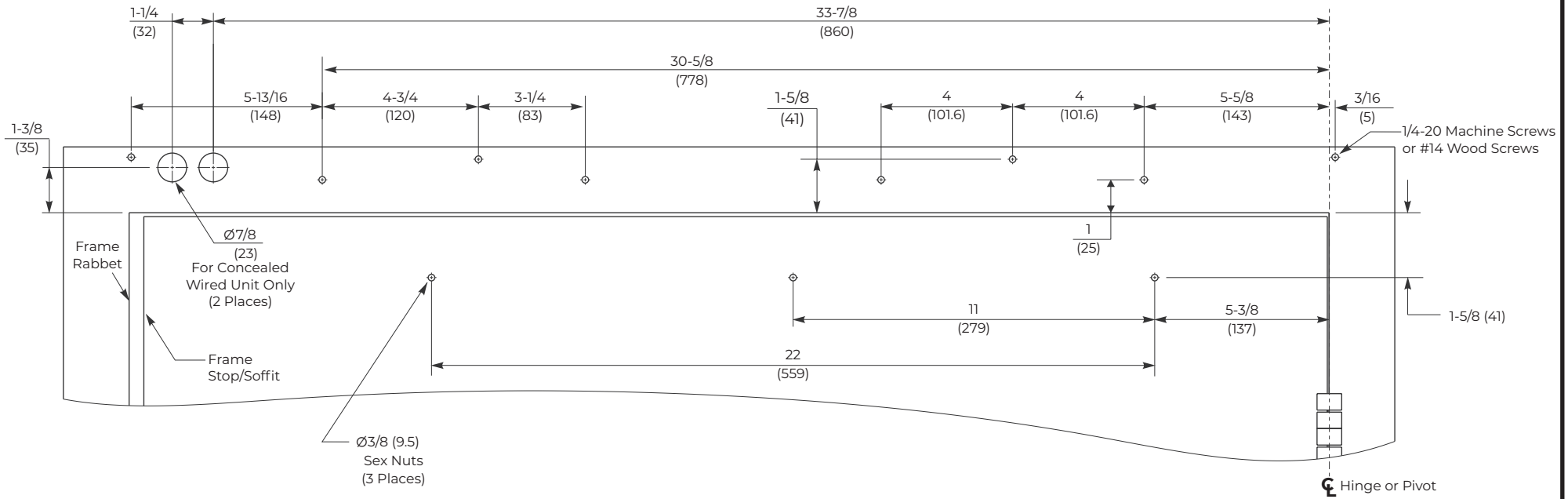

NOTES:

- Do not scale drawing.
- Left hand door shown for pull side.
- All dimensions are given in inches and millimeters.
- Recommended thickness for reinforcements in hollow-metal doors and frames should provide a combined material thickness of .164 (4.2) MIN.
- This template information based upon use of 5 (127) maximum width butt hinges or 3/4 (19) offset pivots.

**6051 Series Template
 for 36"-48" wide door shown with up to 5" Butt Hinges
 Reveal of 1/8" to 3" Maximum Opening of 110°**

Page 3



ASSA ABLOY

TEMPLATE NUMBER	REV	DATE
7360-1048	2	05/23

Approved 2023-07-12