

	Door Leaf Width	OAL (Overall Length)	Dim A	Dim B	Dim D
D6011-36	36 (914)	74-1/4 (1886)	5-9/16 (141)	30-9/16 (776)	30-9/16 (776)
D6011-38	38 (965)	78-1/4 (1988)	7-9/16 (192)	32-9/16 (827)	32-9/16 (827)
D6011-40	40 (1016)	82-1/4 (2089)	9-9/16 (243)	34-9/16 (878)	34-9/16 (878)
D6011-42	42 (1067)	86-1/4 (2191)	11-9/16 (294)	36-9/16 (929)	36-9/16 (929)
D6011-44	44 (1118)	90-1/4 (2292)	13-9/16 (344)	38-9/16 (979)	38-9/16 (979)
D6011-46	46 (1168)	94-1/4 (2394)	15-9/16 (395)	40-9/16 (1030)	40-9/16 (1017)
D6011-48	48 (1219)	98-1/4 (2496)	17-9/16 (446)	42-9/16 (1081)	42-9/16 (1081)

**NOTES:**

- Dimensions shown in inches / (mm) unless specified otherwise.
- Electrical requirements:
  - Power input of 120VAC, 5Amp minimum
  - Accessories circuit for activation to operator and low voltage
- For initial set up, doors must be un-latched and free to move
- For additional installation instructions, see instruction sheet 80-9360-1044-020. Visit [www.NortonRixson.com](http://www.NortonRixson.com)
- Refer to page 2 for proper handling of product

**D6011 Series Template**  
 shown on pairs of 36", 38", 40", 42", 44", 46", and 48" frames  
 shown with up to 5" Butt Hinges  
 Maximum reveal of 1/8"

Page 1



TEMPLATE NUMBER	REV	DATE
7360-1051	3	05/23

Single Pull Side

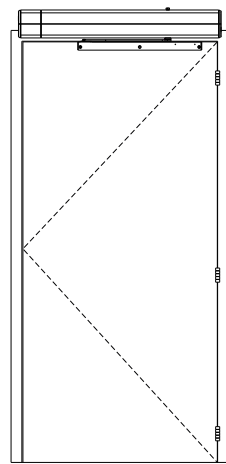

**NOTE:**  
 - All illustrations on this page  
 shown with 36" (914mm) wide  
 doors

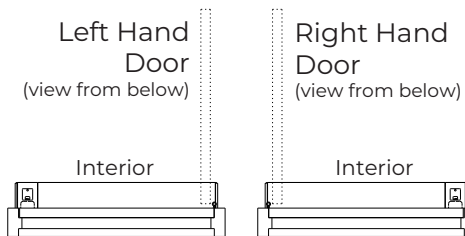

Double Door Pull Side

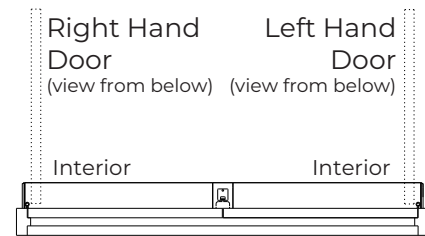
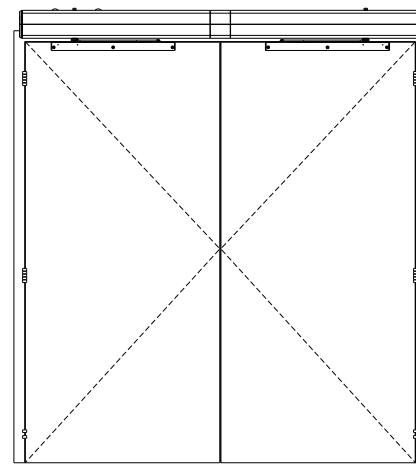

Double Door Double Egress Left Hand

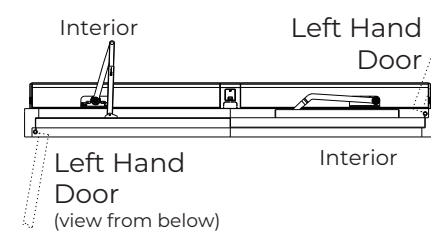
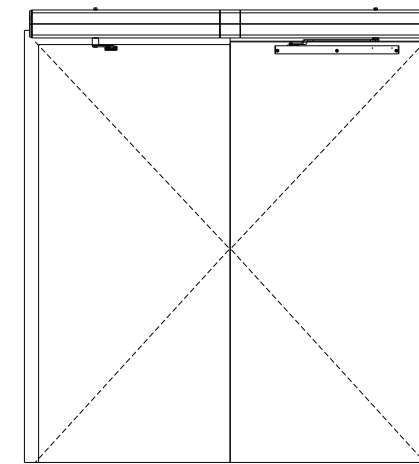

Single Push Side

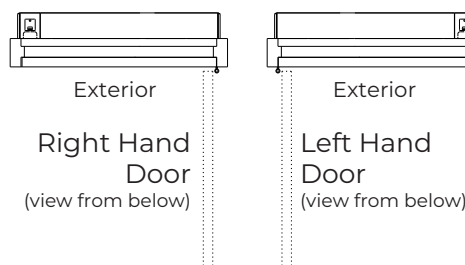
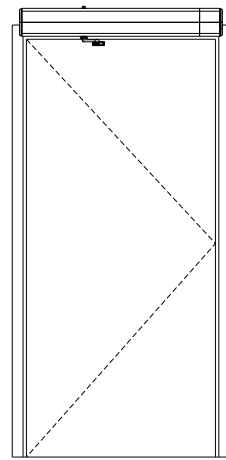

Double Door Push Side

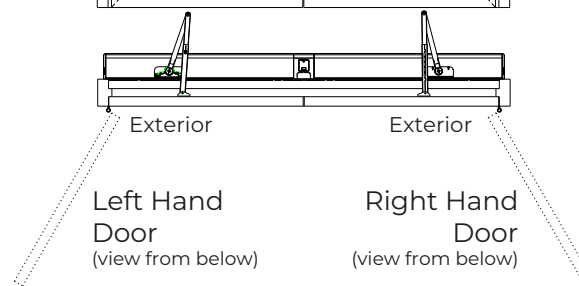
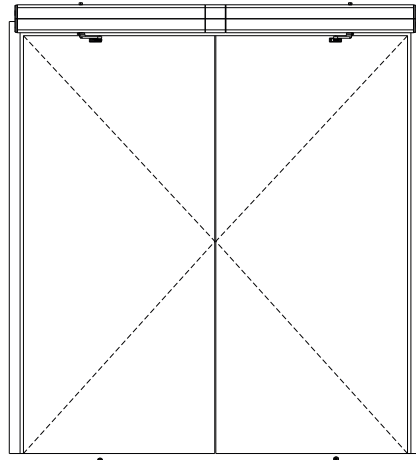

Double Door Double Egress Right Hand

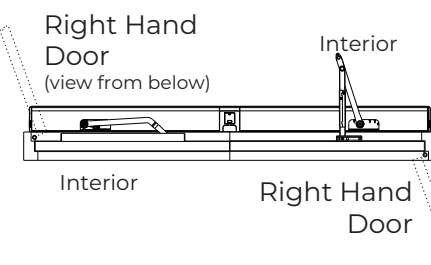
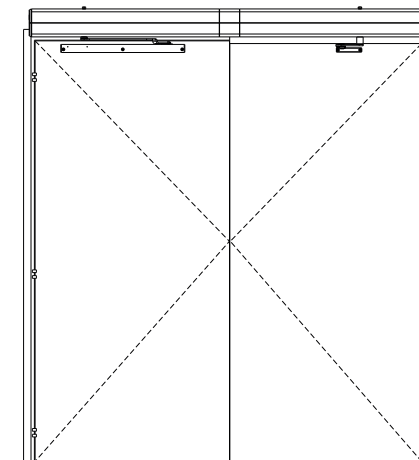

**D6011 Series Template**  
 shown on pairs of 36", 38", 40", 42", 44", 46", and 48" frames  
 shown with up to 5" Butt Hinges  
 Maximum reveal of 1/8"

Page 2



TEMPLATE NUMBER	REV	DATE
7360-1051	3	05/23

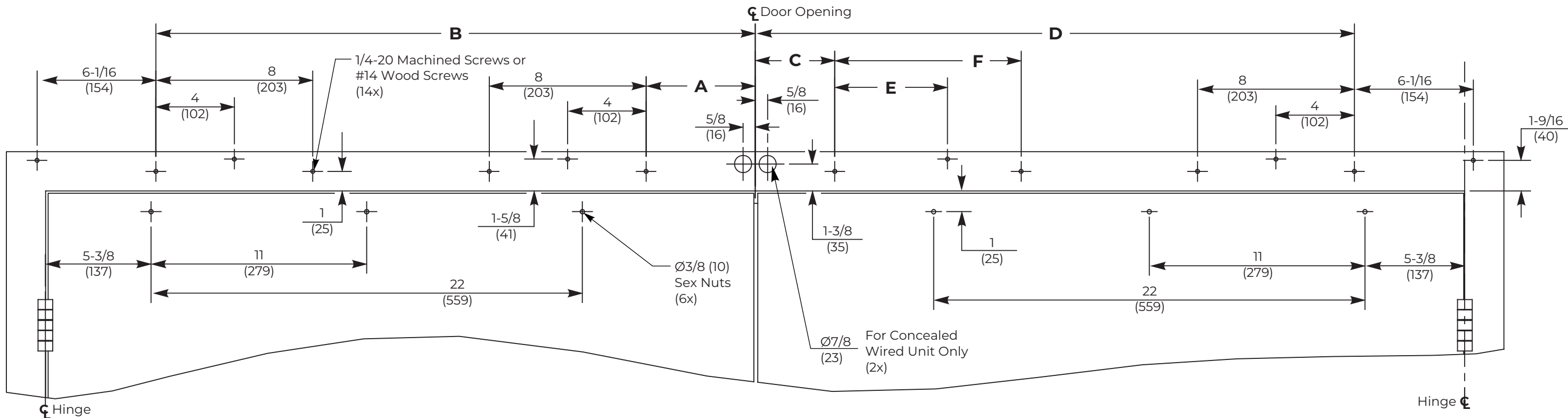

	Dim A	Dim B	Dim C	Dim D	Dim E	Dim F
D6011-36	5-9/16 (141)	30-9/16 (776)	4-1/16 (103)	30-9/16 (776)	5-3/4 (146)	9-1/2 (241)
D6011-38	7-9/16 (192)	32-9/16 (827)	4-1/16 (103)	32-9/16 (827)	7-3/4 (197)	11-1/2 (292)
D6011-40	9-9/16 (243)	34-9/16 (878)	9-9/16 (243)	34-9/16 (878)	4 (102)	8 (203)
D6011-42	11-9/16 (294)	36-9/16 (929)	10-1/16 (256)	36-9/16 (929)	5-3/4 (146)	9-1/2 (241)
D6011-44	13-9/16 (344)	38-9/16 (979)	12-1/16 (306)	38-9/16 (979)	5-3/4 (146)	9-1/2 (241)
D6011-46	15-9/16 (395)	40-9/16 (1030)	14-1/16 (356)	40-9/16 (1017)	5-3/4 (146)	9-1/2 (241)
D6011-48	17-9/16 (446)	42-9/16 (1081)	16-1/16 (408)	42-9/16 (1081)	5-3/4 (146)	9-1/2 (241)

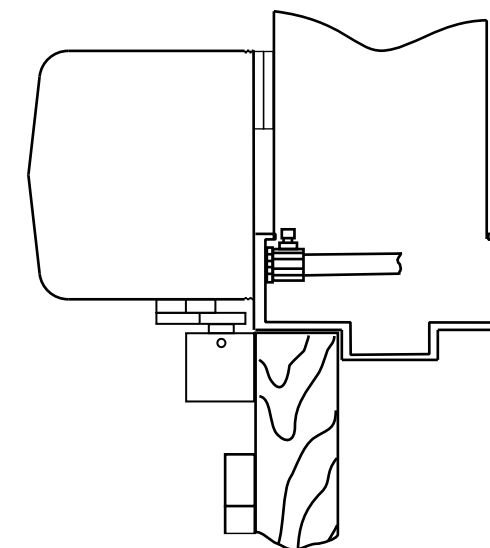
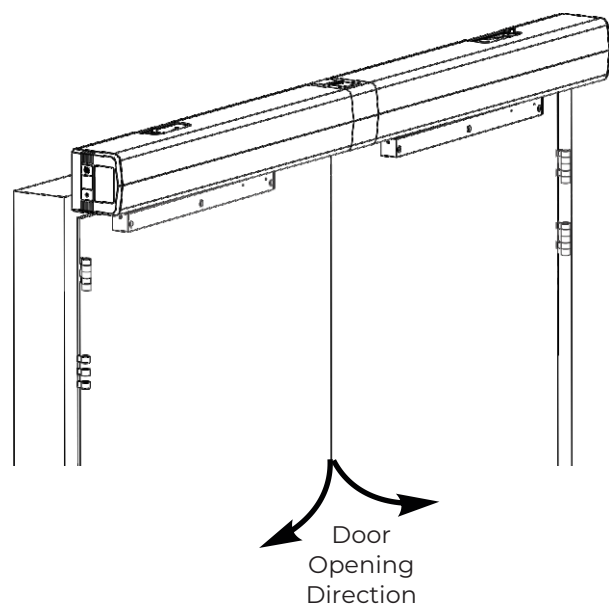

**NOTES:**

- Do not scale drawing.
- Operator shown for pull side double door application.
- All dimensions are given in inches and millimeters.
- Recommended thickness for reinforcements in hollow-metal doors and frames should provide a combined material thickness of .164 (4.2) MIN.
- This template information based upon use of 5 (127) maximum width butt hinges or 3/4 (19) offset pivots.

**D6011 Series Template**  
 shown on pairs of 36", 38", 40", 42", 44", 46", and 48" frames  
 shown with up to 5" Butt Hinges  
 Maximum reveal of 1/8"

Page 3



TEMPLATE NUMBER	REV	DATE
7360-1051	3	05/23