

D6011/D6051 Series

Double Unit Pull Side Power Operator Installation Instructions

⚠ WARNING

This product can expose you to lead which is known to the state of California to cause cancer and birth defects or other reproductive harm. For more information go to: www.P65warnings.ca.gov.

Pour la version française voir NortonRixson.com.
READ AND FOLLOW ALL INSTRUCTIONS.
SAVE THESE INSTRUCTIONS.

D6011 Pull Side Max 1/8" (3mm) reveal

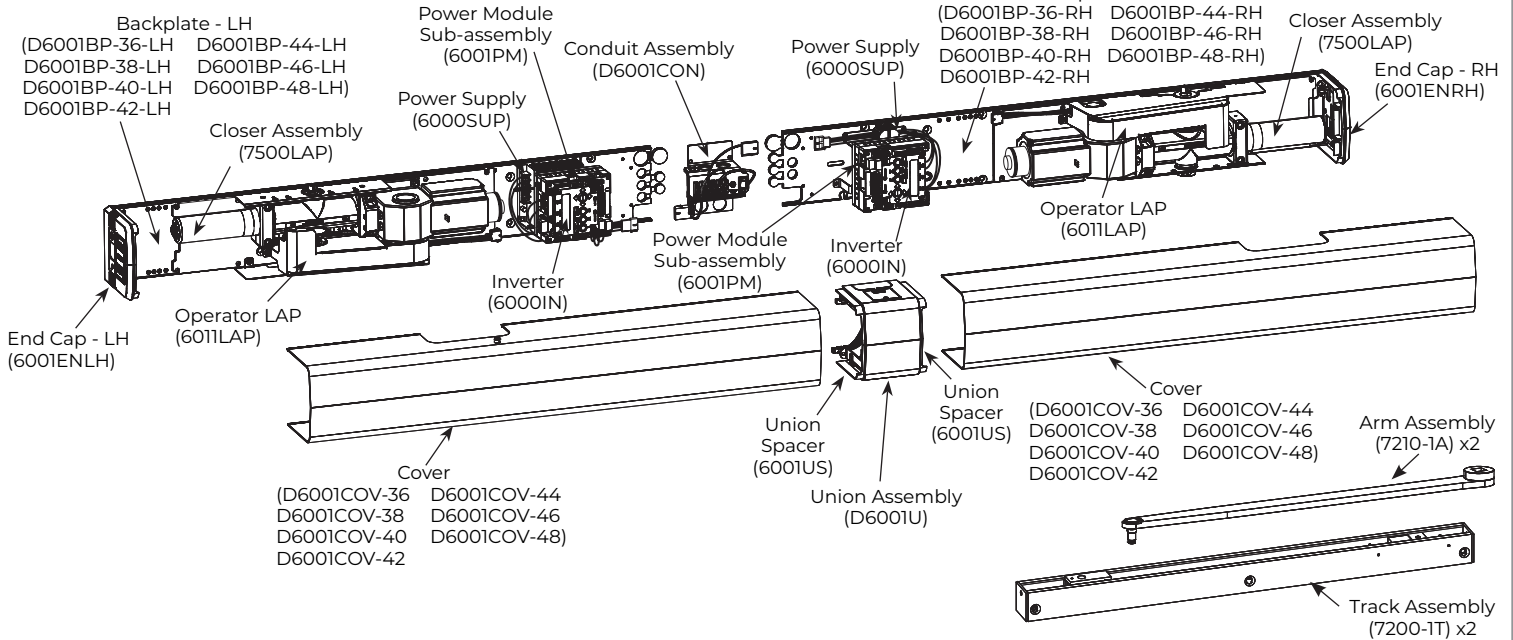

D6051 Pull Side (Handed) 1/8" to 3" (3mm to 76mm) reveal

All components above with 7250-1(R or L) instead of 7210-1A arm

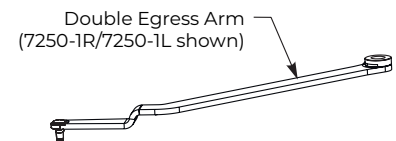

Tools Needed

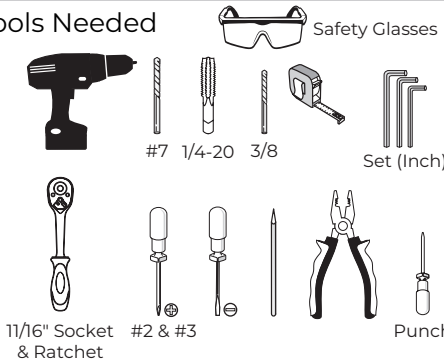

Supplied Fasteners per Operator

NOTE: Fasteners shown are for this specific installation. (Fasteners for other installations are included in the package)

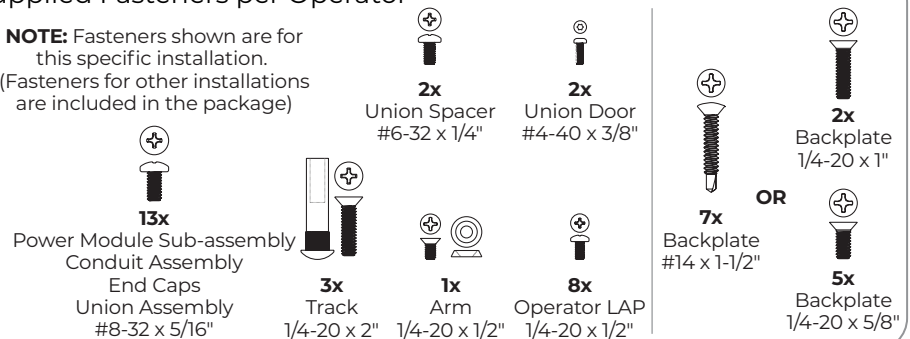

The table below provides a list of documents associated with this product. These documents are available for download from www.nortonrixson.com. If additional information or assistance is needed, contact Technical Product Support.

Document Title	Document Number
6000 Series Double Door Installation Programming Instructions	80-9360-1049-020
Template for installing conduit holes above frame (into wall)	80-7360-1043-020
D6011 Series Template	80-7360-1051-020
D6051 Series Template	80-7360-1054-020

Contents

Certifications and Standards.....	2
Product Safety Warnings	2
General Information	3
Before You Begin	4
Technical Data	4
Prepare Frame and Door.....	5
Install Operator	8
Install Track and Arm	11
Adjustments	12
Connect Sync Cable.....	13
Finalize Installation	13
General Electrical Information	14
Troubleshooting Guide	14

Certifications and Standards

- ETL Certified: Operator conforms to ANSI/UL standard 325 for automatic closing doors and UL10C Positive Pressure Fire Test for Door Assemblies.
- ANSI A156.19: These products are designed to conform to this specification “for power assist and low energy power operated doors.” These products are designed to exceed all the requirements for “Low Energy Power Operated Door”.
- Americans with Disabilities Act (A.D.A.): These door operators can be installed and adjusted to conform with A.D.A. regulations.
- ANSI A117.1: These door controls permit door assemblies to conform to the requirements of this specification “for buildings and facilities - providing accessibility and usability for physically handicap people”.

Product Safety Warnings

WARNING: To reduce risk of injury to person, use this operator only with Pedestrian Swing doors. FOR INDOOR USE ONLY

1. READ AND FOLLOW ALL INSTRUCTIONS.
2. Install only on a properly operating and balanced door. A door that is operating improperly could cause severe injury. Have qualified service personnel make repairs to any hardware before installing the operator.
3. Remove, or make inoperative, all locks (unless mechanically and/or electrically interlocked to the power unit) that are connected to the door before installing the operator.
4. Do not connect the door operator to the source power until instructed to do so.
5. Never let children operate or play with door controls. Keep remote control (when provided) away from children.
6. Personnel should keep away from a moving door in motion.
7. Test door’s features at least once a month. After adjusting either force or limit of travel, retest door operator’s features. Failure to adjust operator properly may cause severe injury or death.
8. KEEP DOOR PROPERLY OPERATING. An improperly operating door could cause severe injury or death.
9. SAVE THESE INSTRUCTIONS.

General Information

Operation:

Your Low Energy Operator can be configured in three variations to meet the standards:

1. Push plates, Wave-to-open switches, etc. are available to activate the operator.
2. Push & Go can be enabled. In this mode, your door is pushed (or pulled) slowly 15° manually, and then automatically opens to full open position.
3. Door can be used as a manual door. The door will work and act like a standard door closer, with or without power, when pushed or pulled open manually. If Push & Go is enabled and door is opened quickly, door will function as a manual door (energy save feature). Push plates are still active.

If desired, overhead presence devices can be provided for an extra level of protection. Consult local authority having jurisdiction. These are not required by current ANSI/BHMA A156.19 standards.

Opening:

When an opening signal is received by the control unit, the door opens to the fully open position. The open position is held by the motor and is adjustable from 0 to 30 seconds. If the door is obstructed while opening, the door will stop; the operator will sense obstruction (obstruction time is adjustable from 0 to 5 seconds) and the door will close.

NOTE: Door must be visible by person operating activation switch(s). Switch(s) to comply with ANSI/BHMA requirements. Auxiliary door stop (by others) required.

Closing:

When the hold open time has elapsed, the door closer will close the door automatically. The door will slow to low speed at latch before it reaches the fully closed position. The door is kept closed by spring force of the closer. If the door is obstructed while closing, the door will stop against the obstruction; the operator will sense obstruction and reopen to fully open position after obstruction time has been reached. Once the hold open time has elapsed a second time, the door closer will close the door automatically. If the door is obstructed during this second closing cycle, the door will stop and rest against the obstruction using only the force of the closer spring. To reset, allow door to fully close and re-activate push plates to test operation.

Infinite Hold Open:

An optional feature to be used if door is desired to be held open for more than 30 seconds.

Set selector mode switch on underside of union assembly to hold open. Door will immediately begin to open to the fully open position. Once door is fully open, brake on end of motor energizes holding door in open position. To release from hold open, if door is set up for executive operation (see Programming Instructions, document #80-9360-1049-020 for executive wiring instructions), door can be closed with activation device. A pull on the door will also allow the unit to be taken out of hold open. Once door has closed, the door will reopen to fully open position unless activation device is pressed or selector mode switch is changed from hold open position.

NOTE: Door must be visible by person operating activation switch(s). Switch(s) to comply with ANSI/BHMA requirements. Auxiliary door stop (by others) required.



WARNING: Make sure (120V, 60Hz) input power is turned OFF at facility's main circuit breaker before proceeding with installation

Before You Begin

- All dimensions are given in inches. DO NOT scale drawings.
- Thickness recommended for reinforcements in hollow metal doors and frames is charted.
- This template information based upon use of 5" maximum width butt hinges.
- Maximum frame reveal is 1/8" for D6011 units and 1/8" up to 3" maximum for D6051 units.
- Before beginning the installation, verify that the door frame is properly reinforced and is well anchored in the wall. Frame header must be straight - without warp or bow.
- Unreinforced hollow metal frames and aluminum frames should be prepared and fitted with 1/4-20 blind rivet nuts, furnished by others.
- Concealed electrical conduit and concealed switch or sensor wires should be pulled to the frame before proceeding.

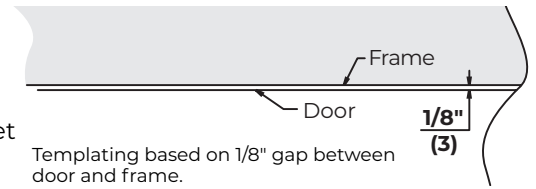

Fasteners for Frame:

- 1/4-20 Machine screws for hollow metal and aluminum.
- #14 x 2-3/4" (70mm) long sheet metal screws for wood.

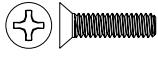
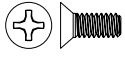

Templating based on 1/8" gap between door and frame.

Hollow Metal Door Frame Reinforcing		
Frame Material	Reinforcing	
	Recommended	Min. Required
12 Ga. .105 (2.66)	12 Ga. .105 (2.66)	18 Ga. .048 (1.21)
14 Ga. .075 (1.90)	10 Ga. .134 (3.41)	12 Ga. .105 (2.66)
16 Ga. .060 (1.52)	10 Ga. .134 (3.41)	12 Ga. .105 (2.66)
18 Ga. .048 (1.21)	8 Ga. .164 (4.18)	10 Ga. .134 (3.41)

Mounting Hardware	Door or Frame	Drill
 Backplate: 14 x 1-1/2 Oval Head Self Drilling Screw	Wood	3/16" (4.76mm)
 Backplate: 1/4-20 x 1 Flat Head Machine Screw	Metal	Drill #7 (.201 dia. or 5.10mm) Tap 1/4-20
 Backplate: 1/4-20 x 5/8 Flat Head Machine Screw		
 Track: Sex Nut and Bolt (SNB) (optional)	Hollow Metal	9/32" (7.00mm) thru 3/8" (9.50mm) door face opposite to closer
	Aluminum or Wood	3/8" (9.50mm) thru

Technical Data

Input power:	120VAC, 60Hz
Power consumption:	.9 amps
Circuit breaker:	3 amps
Power supply:	24 V DC, max. 2.2 amp.
Door width:	36" - 48" (91-122 cm)
Door weight:	100-250 lb. (43-113 kg)
Door opening angle:	up to 110° with reveal of 3" (7.6 cm) max
Hold open time:	0-30 seconds (A.D.A. 5 seconds min.) Indefinite for optional Infinite Hold Open

NOTES:

- Permanent wiring is to be implemented as required by local codes.
- Activation devices: push plates, access control, mats, touchless wall switches, etc.
- Maximum wire size is:
 - 12AWG at terminals LINE and NEUTRAL (120VAC; 60Hz) on Power Input Terminal mounted on inside of end cap.
 - 14AWG at all other terminals
- Rate of operation shall not exceed 300 cycles of opening and closing per hour.

Prepare Frame and Door

Become familiar with operator components and fasteners. It is recommended that components remain in boxes until installed. Verify there is minimum ceiling clearance for operator installation before proceeding. (Figure 1)

A. Prepare frame.

1. Determine if push or pull installation. (Figure 2)

NOTE: These instructions are for Pair of Doors, PULL only. See 80-9360-1045-020 instructions for D6021/D6031 or 80-9360-1046-020 instructions for D6061/D6071 Push installation.

2. Frame header MUST be flat / without twists. Backplates can be used as reference.

NOTE: If frame is not flat or is twisted, additional steel back plates or shimming is required. Failure to mount units properly can result in improper function of operator or inability to snap on covers.

3. Mark center of opening on frame header between jambs.

4. Using chart, mark from center of opening to **left**. (Figure 3)

NOTE: Template available for download from www.nortonrixson.com.

5. Measure 1" up from bottom of frame header and mark at Dim A and Dim B locations.

6. Drill holes.

7. Using supplied backplate screw pack in Box 1, insert screws into prepared mounting holes.

For Metal Frame: Use two (2) 1/4-20 x 1" flat head machine screws.

For Wood Frame: Use two (2) #14 x 1-1/2" oval head self-drilling screws.

NOTE: Do not tighten mounting screws at this time. Leave 5/16" minimum (thickness of backplate) between frame face and back of screw head.

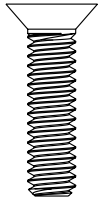

OR

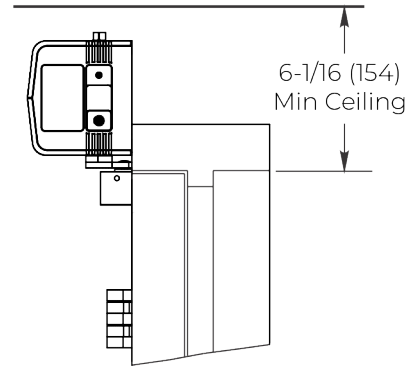
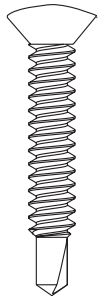

Figure 1

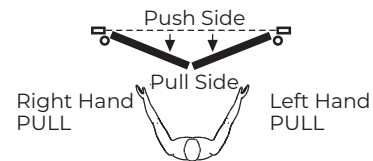
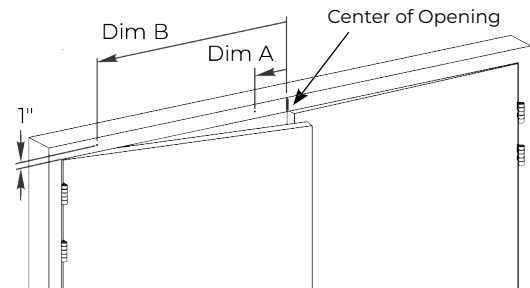

Figure 2



Door Size	Dim A	Dim B
Pair of 36" doors:	5-9/16" (141mm)	30-9/16" (776mm)
Pair of 38" doors:	7-9/16" (192mm)	32-9/16" (827mm)
Pair of 40" doors:	9-9/16" (243mm)	34-9/16" (878mm)
Pair of 42" doors:	11-9/16" (294mm)	36-9/16" (929mm)
Pair of 44" doors:	13-9/16" (344mm)	38-9/16" (979mm)
Pair of 46" doors:	15-9/16" (395mm)	40-9/16" (1030mm)
Pair of 48" doors:	17-9/16" (446mm)	42-9/16" (1081mm)

Figure 3

B. Mount Backplates.

1. Select backplate with 2 “fingers” for interlocking plates and marked **“Mount This Plate First”** from Box 1. (This is LEFT backplate.)
2. Slide left backplate over mounting screws. (Figure 4)
3. Use level in backplate to align then tighten mounting screws. (Figure 4)
4. Interlock right backplate (3 “fingers”) from Box 2 with left backplate. (Figure 5)
5. Use level on right backplate to ensure proper alignment. (Figure 5)
6. Using backplate as template, mark conduit slot and Dim D mounting hole. (Figure 5)
7. Drill hole for mounting screw at Dim D.
8. Using supplied backplate screw pack in Box 2, insert screw into prepared mounting hole. (Figure 6)

NOTE: Left backplate conduit slot is ALWAYS at bottom of plate and toward center of opening.

NOTE: Right backplate conduit slot is ALWAYS at bottom of plate and center of opening.

NOTE: Dim D should be 1" up from bottom of frame header if backplate is properly aligned.

For Metal Frame: Use one (1)
1/4-20 x 1" flat head machine screw.

For Wood Frame: Use one (1)
#14 x 1-1/2" oval head self-drilling screw.

NOTE: Do not tighten mounting screw at this time. Leave 5/16" minimum (thickness of backplate) between frame face and back of screw head.

9. Using countersunk holes in backplates as a template, drill/tap remaining eleven (11) mounting holes: 1/4-20 for steel frame or #14 for wood frame. (Figure 6)

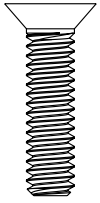

OR

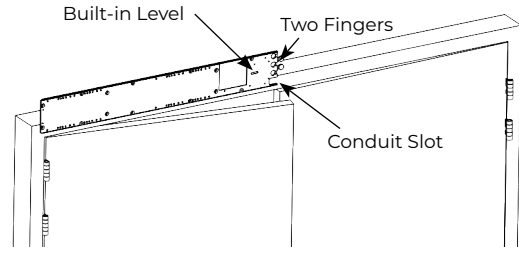
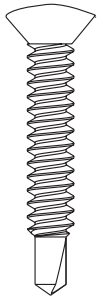

Figure 4

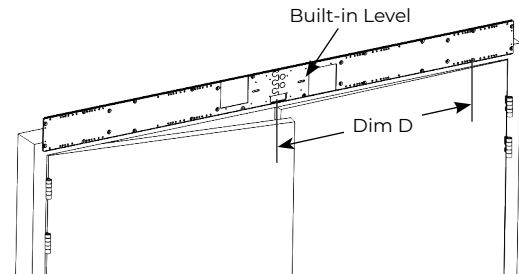

Figure 5

Door Size	Dim D
Pair of 36" doors:	30-9/16" (776mm)
Pair of 38" doors:	32-9/16" (827mm)
Pair of 40" doors:	34-9/16" (878mm)
Pair of 42" doors:	36-9/16" (929mm)
Pair of 44" doors:	38-9/16" (979mm)
Pair of 46" doors:	40-9/16" (1030mm)
Pair of 48" doors:	42-9/16" (1081mm)

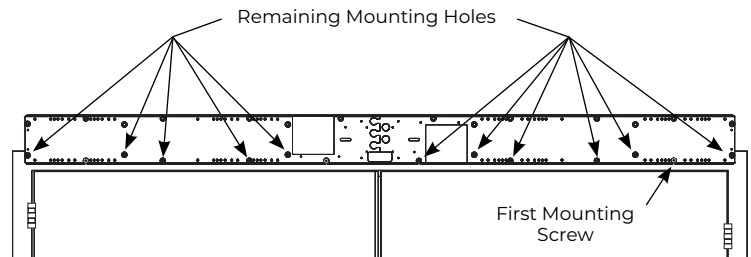

Figure 6

C. Secure Backplates.

- Secure backplates to frame using eleven (11): 1/4-20 x 5/8" machine screws or 1/4 x 1-1/2" self-drilling screws from screw packs in Boxes 1 and 2 (Figure 7).



NOTE: It is important to properly secure top edge of backplate. Use of blocking (supplied by others) or shims (provided) to fill gap between backplate and wall above header is HIGHLY recommended. Material must comply with local codes. Failure to properly secure top of backplate could result in operator being allowed to 'rock' during operation. This could result in damage to operator and diminish operator function. (Figure 7)

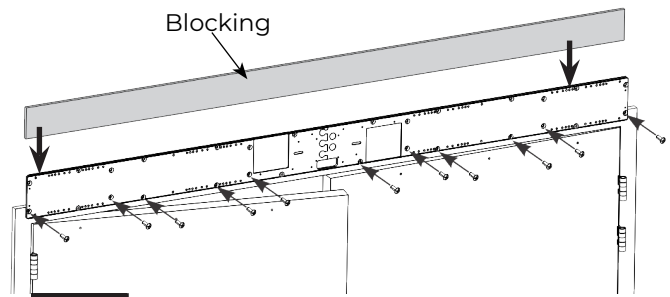
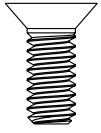
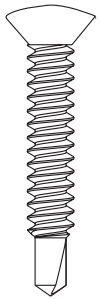

Figure 7



OR



D. Prepare doors for Tracks.

- Locate and prepare track holes in doors. (Figure 8)

NOTE: Template available for download from www.nortonrixson.com.

- Drill 3/8" (9.5mm) through (6 places) for sex bolts.

Dim A	Operator Model
1-1/16" (27mm)	6011
1-11/16" (43mm)	6051

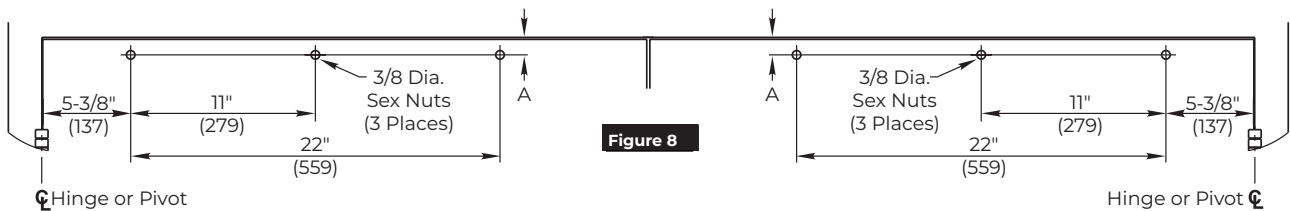

Figure 8

Install Operator

A. Install End Caps.



1. Secure end caps to each end of connected backplates using four (4) (two each) #8-32 x 5/16" Phillips pan head screws. (Figure 9)

NOTE: Orient end caps so that text on labels is legible when observed from ground.

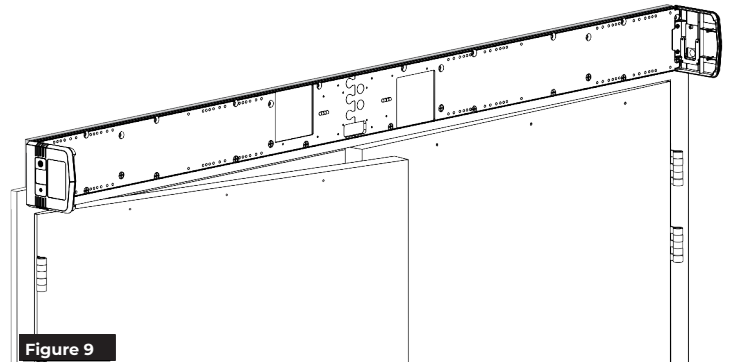
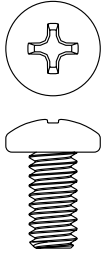

Figure 9

B. Install Operator LAP.

NOTE: Backplates are printed with text to assist installation.



1. With backplates mounted to frame, use text to locate holes along bottom of backplates that correspond to your specific closer installation. (Figure 10)
2. Insert two (2) 1/4-20 x 1/2" Phillips pan head screws on each backplate into appropriate engraved locations. Leave a 5/16" minimum gap between backplate and underside of screw head.
3. On each backplate, orient LAP so spring tube of closer is pointed toward closest hinge edge of frame. Slide each LAP over two (2) screws and tighten. (Figure 11)

NOTE: When properly oriented, spring tube is at bottom on left hand backplate (Figure 11) and at top on right hand backplate.

4. For each LAP, use six (6) 1/4-20 x 1/2" Phillips head screws to secure. (Figure 12)

NOTES:

- Holes in LAP align with threaded holes in backplate.
- Screws to be torqued to 80 in-lb minimum.

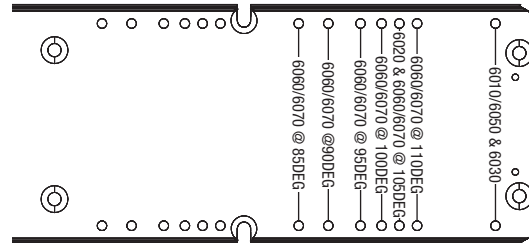
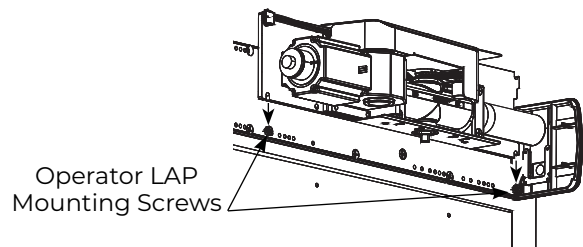

Figure 10



Operator LAP
Mounting Screws

Figure 11 Left Hand LAP shown

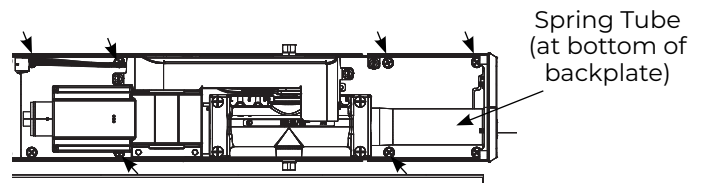

Figure 12 Remaining LAP Mounting Screws - Left Hand View

C. Install Conduit Assembly and wire to building.

1. Orient conduit assembly so two (2) conduit holes are at bottom and text on wire input label is legible. (Figure 13)

2. Secure assembly to backplate using four (4) #8-32 x 5/16" Phillips head screws. (Figure 13)

WARNING: BUILDING POWER MUST BE OFF BEFORE PROCEEDING!

3. Secure conduits to conduit assembly (surface or concealed conduit). (Figure 14)

4. Wire building 120VAC to conduit assembly – LINE, NEUTRAL, and GROUND. (See General Electrical Information on page 14.)

5. Wire 24VDC for accessories to conduit assembly 24VDC +/- as required. (See General Electrical Information on page 14.)

WARNING: DO NOT TURN ON BUILDING POWER UNTIL DIRECTED TO DO SO! RISK OF INJURY OR DEATH!

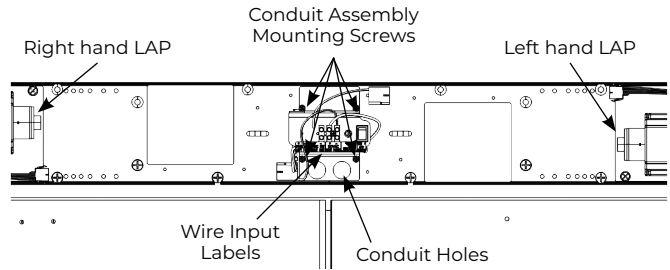

Figure 13

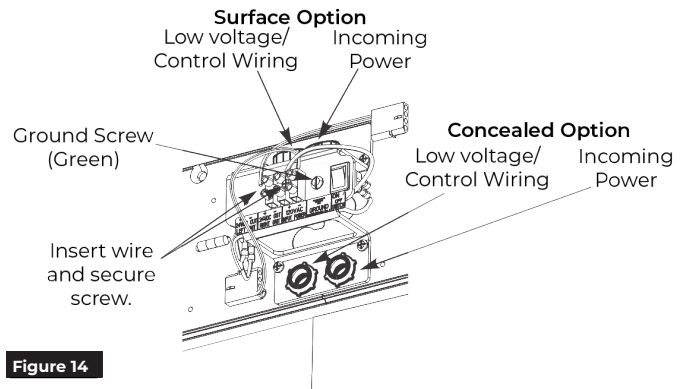

Figure 14

D. Install Power Module Sub-assemblies.

1. Using three (3) #8-32 x 5/16" Phillips screws per assembly, secure power module sub-assemblies to backplate at location marked on backplates. (Figure 15)

NOTE: Orient assemblies so LCD screens on inverters are toward corresponding closer assemblies. (Figure 15)

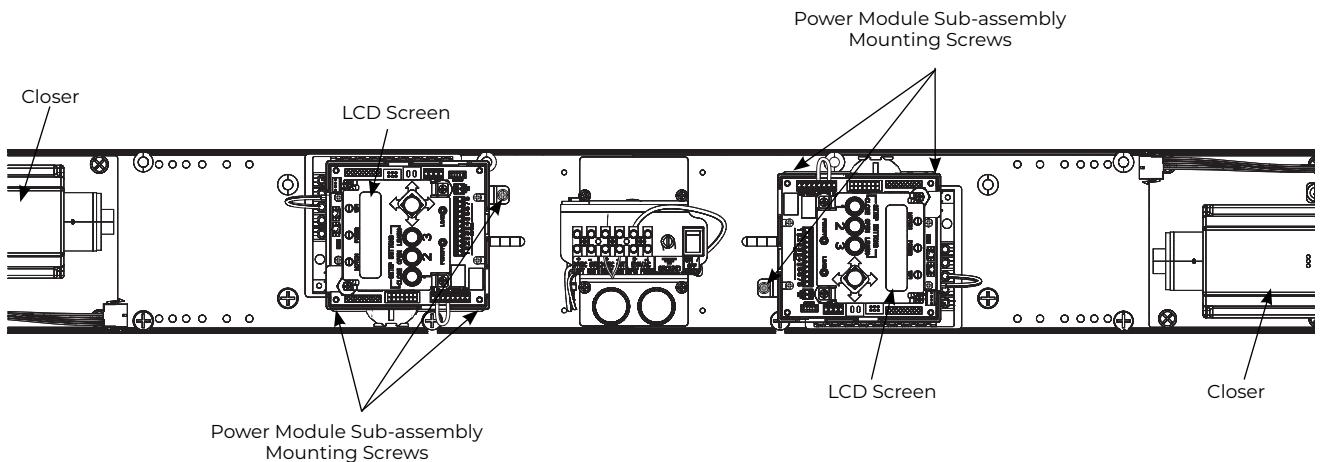
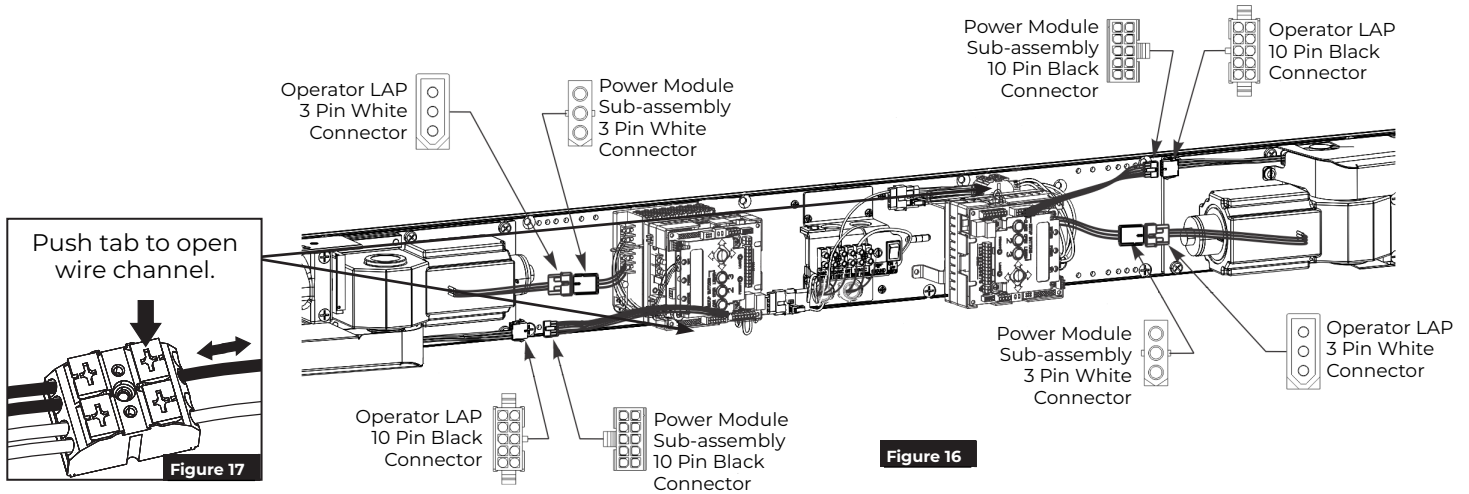

Figure 15 Wiring Removed From View

E. Connect Power Module Sub-assemblies to LAPS.

⚠ Power module wiring may loosen during shipping. Gently tug each wire on the connector. If a wire is loose, push the connector tab and reinsert wire. Release tab and verify the wiring is secure. (Figure 17)

1. Attach 10-pin black connectors between each power module sub-assembly and its operator LAP. (Figure 16)
- NOTE:** Connectors are keyed and only attach one way.
2. Attach 3-pin white connectors between each power module sub-assembly and its operator LAP. (Figure 16)



F. Install Union Assembly.

1. Orient union assembly so access door covering selector mode switches faces floor. (Figure 18)
2. Secure union assembly to backplate using four (4) #8-32 x 5/16" Phillips pan head screws. (Figure 18)
3. Connect 4-pin black square connector from power module sub-assembly to 4-pin black connector from union assembly for each operator. (Figure 19)

NOTE: Connectors are keyed and only assembly one way.

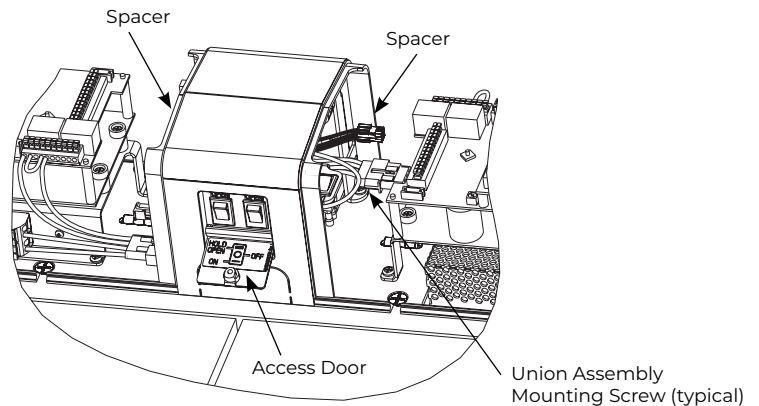

Figure 18 Union Assembly - View From Floor

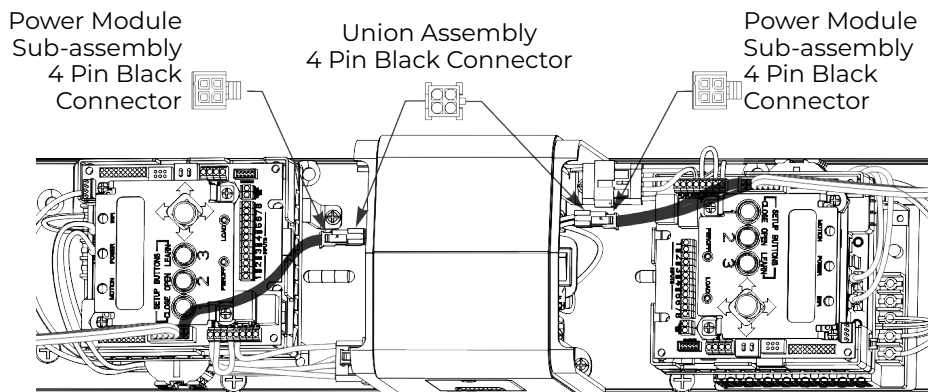

Figure 19

Install Track and Arm

A. Mount Tracks to doors.



- Using previously prepared holes in doors, install three (3) 1/4-20 x 1-5/8" screws through each track and into sex bolts. (Figure 20)

NOTES: (Figure 21)

- Opening of track is toward top of door.
- Adjustable bumper stop is toward hinge edge of door.

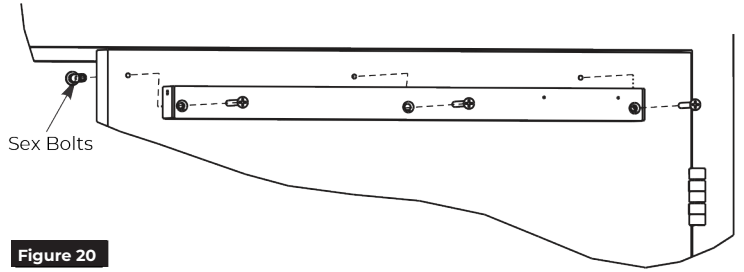

Figure 20

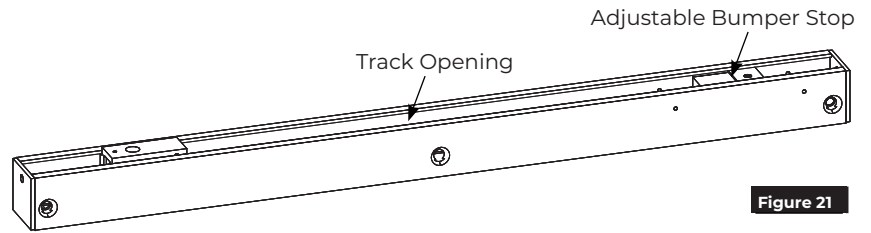
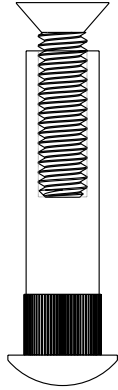

Figure 21



B. Install Arm Assemblies To Tracks.

- Open door of your choosing.
- Using an adjustable wrench, rotate top pinion 45 degrees toward door hinge. You will feel resistance from spring. (Figure 22)
- While holding pinion at 45 degrees**, slide arm on bottom pinion parallel to frame as shown. (Figure 22)

NOTE: Pinion flat should be aligned as shown. (Figure 23)

- Secure arm to pinion with 1/4-20 x 1/2" screw and countersunk patch washer. (Figure 22)
- Insert stud on arm into slider in track by pressing clip on backside of slider onto stud. (Figure 24)

- To adjust track stop:

- Use allen wrench to loosen set screw in bumper stop.
- Open door to full open position.
- Slide bumper stop until it just touches end of slider.
- Tighten set screw in bumper stop so bumper will stay in position. (Figure 25)

- Repeat on second door.

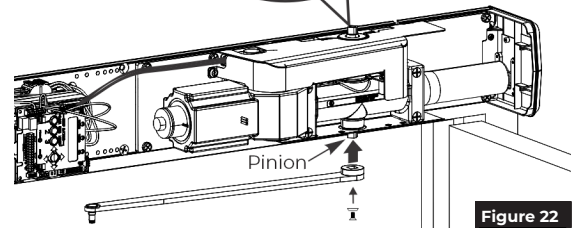
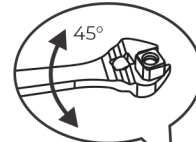

Figure 22

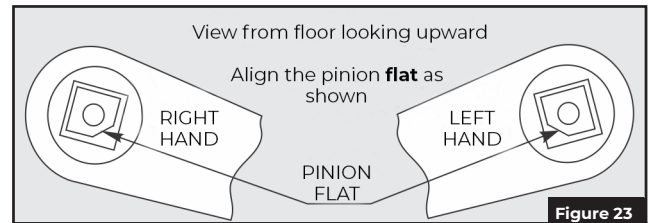
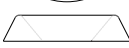
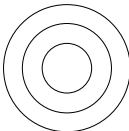

Figure 23

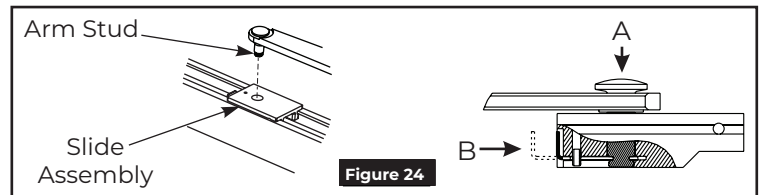

Figure 24

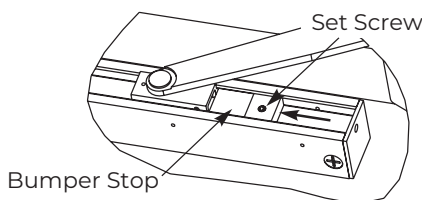

Figure 25

Adjustments

A. Adjust mechanical closer features on each operator.

NOTES:

- Make necessary mechanical adjustments so unit functions as a standard surface mounted door closer before adjusting spring force, applying power, adding accessories or making electrical/programming adjustments.
- Valve location S/D is not adjustable.
- Chain protection plate cutouts allow access to valves. Use hex wrench to make adjustments. (Figure 26)

⚠ Do not remove valves from closer. Hydraulic oil will escape.

1. Closing Speed Controls (Figure 26)
 - Valve "S" controls Sweep Range from full open to 10°.
 - Valve "L" controls Latch Range from 10° to closed.
2. Opening Cycle (Figure 26)
 - Valve "B" controls strength of cushioning in Backcheck Range.

⚠ NOTE: NEVER close Backcheck valve completely – it is not to provide a positive stop.

- Valve "P" adjusts angle that backcheck is felt in open cycle. Factory preset is typically acceptable.

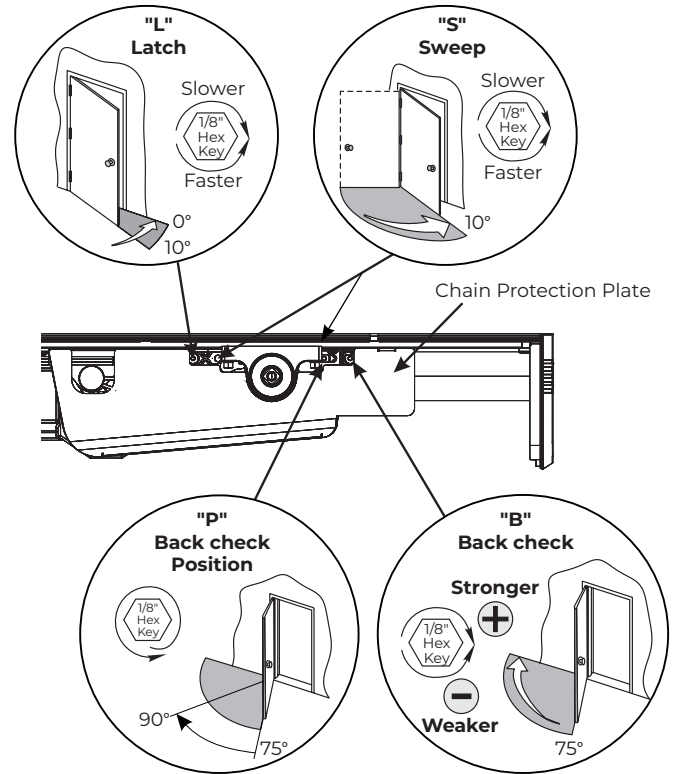

Figure 26 View of Left Hand operator from ceiling looking down

B. Adjust spring force on each operator.

NOTES:

- The amount of effort to manually open or close a door is called force and is controlled by the operator's closer spring.
- Make necessary mechanical adjustments described in "A" above.
- A closer set to ADA required 5 lbs opening force may not be strong enough to close door due to latching hardware, air pressure, or frame issues.

1. Remove the small torx head screw from end cap.
2. Slide the End Cap Access door, exposing the spring adjustment nut.
3. Using a ratchet with an 11/16" socket, turn the nut in end of closer body tube clockwise to increase or counterclockwise to decrease force until the desired setting is reached. (Figure 27)
4. Once the desired force has been set:
 - Remove the ratchet.
 - Slide the end cap access door closed.
 - Replace the end cap screw

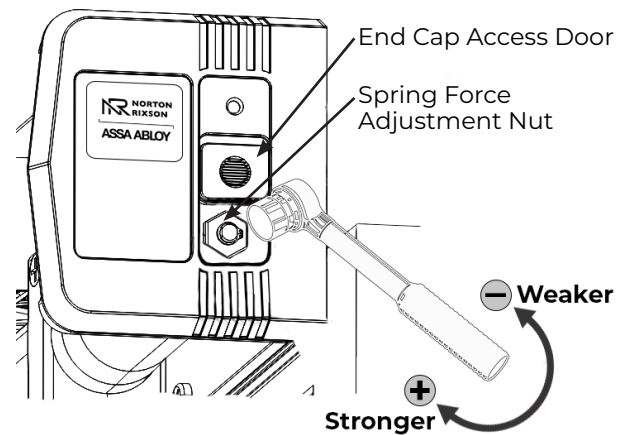

Figure 27 View of Right Side Operator

Connect Sync Cable

1. Determine which door will be Master.
2. Run Sync Cable between operators.
 - Attach end of Sync Cable marked "M" to 4-pin connector on top of inverter board on unit selected as Master Door.
 - Attach other end of Sync Cable marked "F" to 4-pin connector on top of inverter board selected as Follower Door.

NOTE: Connectors are keyed and only attach one way.

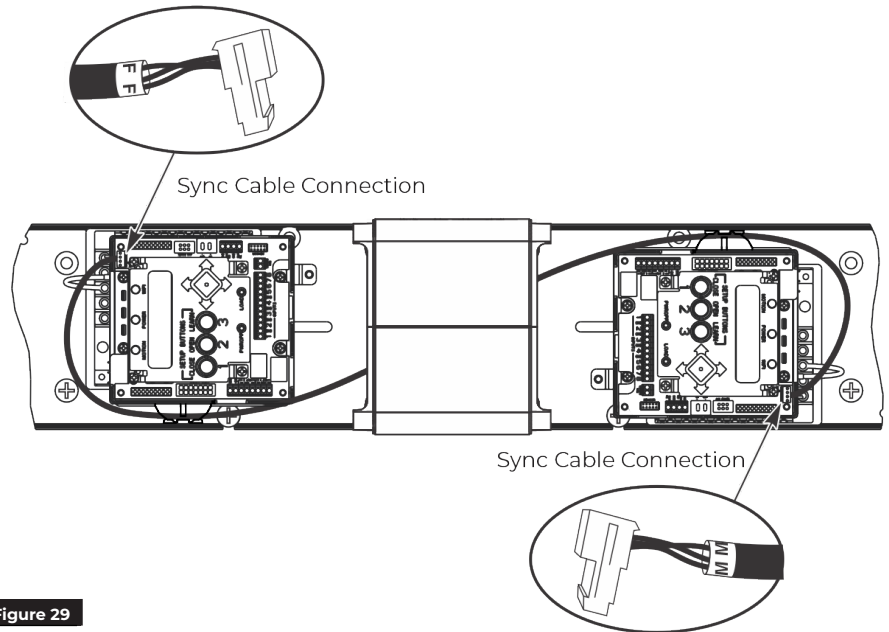

Figure 29

Finalize Installation

Adjust covers to finalize installation

1. Align cut-outs in each cover to corresponding pinion shafts.
2. Slide covers onto units using end caps and union spacers as guides.

NOTE: Verify all wiring and sheet metal guards are inside cover.
3. Snap covers securely to backplates. Pull on covers to verify they are secure.

NOTE: If cover will not securely snap onto backplate, verify backplate is not warped or twisted. Additional support or shimming may be required. See Sections A & B under Prepare Frame and Door.

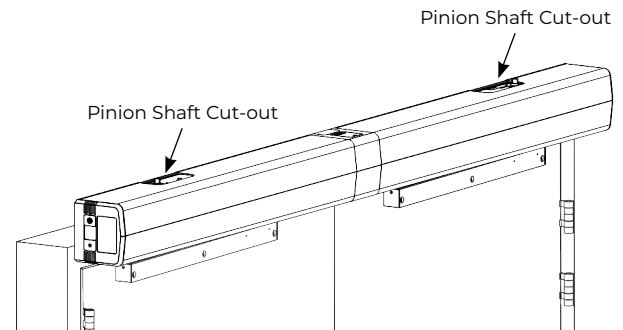

Figure 28



WARNING: Make sure no wiring is loose or can be caught by cover when it is snapped into place.

The **D6011 or D6051 PULL SIDE Low Energy Operator** has now been installed.
Continue with separate Programming Manual 80-9360-1049-020
for operator setup and adjustments.

This page intentionally left blank.

The ASSA ABLOY Group is the global leader in access solutions. Every day we help people feel safe, secure and experience a more open world.



ASSA ABLOY

This page intentionally left blank.

Technical Product Support:
Monroe, NC 28112 USA
Phone: 877.974.2255 ext: 2
Techsupport.NortonRixson@assaabloy.com
NortonRixson.com

Norton Rixson is a brand associated with ASSA ABLOY Accessories and Door Controls Group, Inc., an ASSA ABLOY Group company. Copyright © 2023, 2024, ASSA ABLOY Accessories and Door Controls Group, Inc. All rights reserved. Reproduction in whole or in part without the express written permission of ASSA ABLOY Accessories and Door Controls Group, Inc. is prohibited.

Approved 2024-02-13

80-9360-1044-020 Rev 2 01/24