

Notes:

- Dimensions shown in inches / (mm) unless specified otherwise.
- Electrical requirements:
 - Power input of 120VAC, 5Amp minimum
 - Accessories circuit for activation to operator and low voltage
- For initial set up, doors must be un-latched and free to move
- For additional installation instructions, see instruction sheet 80-9360-1027-020. Visit www.nortondoорcontrols.com
- Refer to page 2 for proper handling of product

6021 Series Template
shown on 36" and 42" frames
shown with up to 5" Butt Hinges
Maximum reveal of 6-7/8" and
Maximum of 110 degrees of opening

Single Push Side

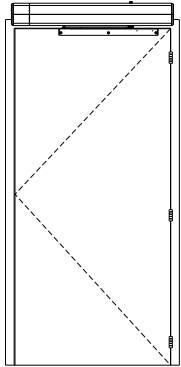

NOTE:
- All illustrations on this page shown with 36" (914mm) wide doors

Left Hand Door
(view from below)

Right Hand Door
(view from below)

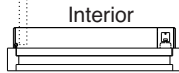
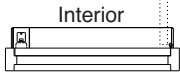

Double Door Push Side

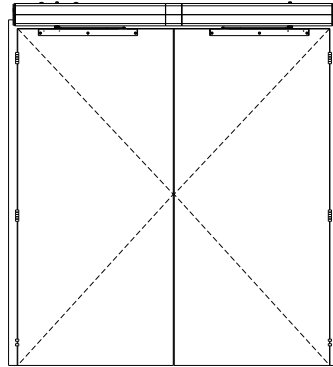

Right Hand Door
(view from below)

Left Hand Door
(view from below)

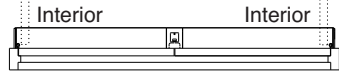

Double Door Double Egress Left Hand

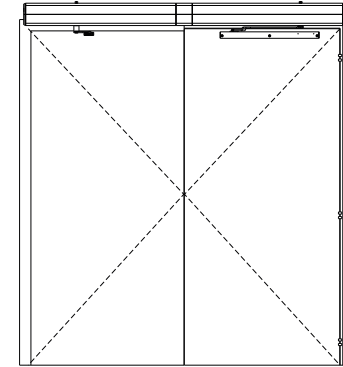

Interior

Left Hand Door



Left Hand Door
(view from below)

Interior

Single Pull Side

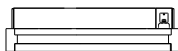
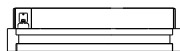
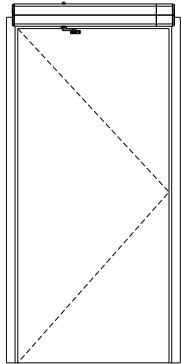

Exterior

Exterior

Right Hand Door
(view from below)

Left Hand Door
(view from below)

Double Door Pull Side

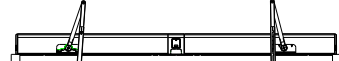
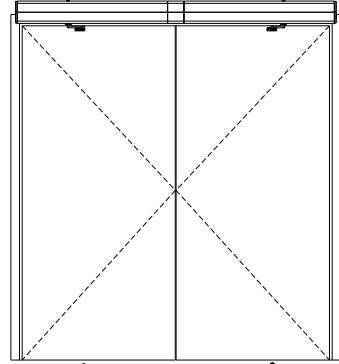

Exterior

Exterior

Left Hand Door
(view from below)

Right Hand Door
(view from below)

Double Door Double Egress Right Hand

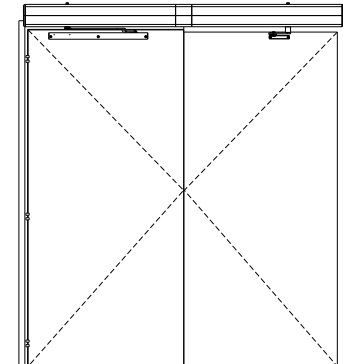

Right Hand Door
(view from below)

Interior



Interior

Right Hand Door

6021 Series Template
shown on 36" and 42" frames
shown with up to 5" Butt Hinges
Maximum reveal of 6-7/8" and
Maximum of 110 degrees of opening

Page 2

Norton[®]

ASSA ABLOY

www.nortondoortcontrols.com

TEMPLATE NUMBER	REV	DATE
80-7360-1046-020	1	06/20

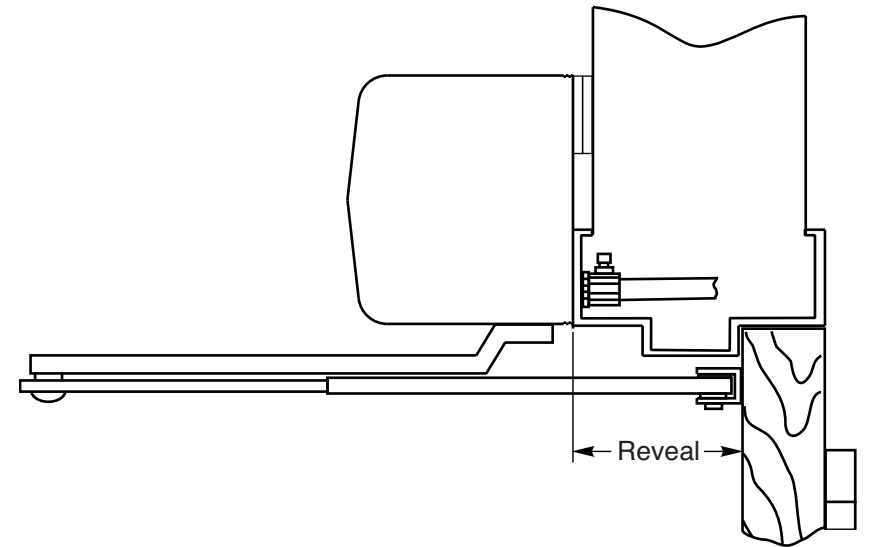
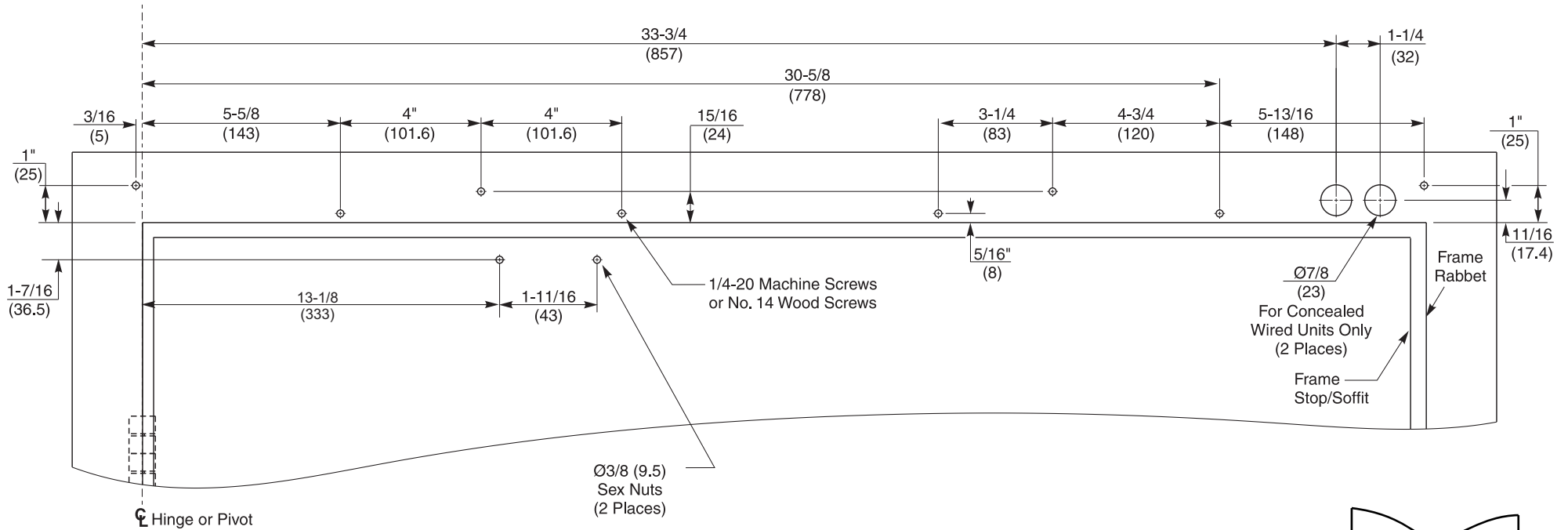

Notes:

- Do not scale drawing.
- Left hand door shown for push side.
- All dimensions are given in inches and millimeters.
- Recommended thickness for reinforcements in hollow-metal doors and frames should provide a combined material thickness of .164 (4.2) MIN.
- This template information based upon use of 5 (127) maximum width butt hinges or 3/4 (19) offset pivots.

6021 Series Template
shown on 36" and 42" frames
shown with up to 5" Butt Hinges
Maximum reveal of 6-7/8" and
Maximum of 110 degrees of opening

Page 3

Norton®

ASSA ABLOY

www.nortondoorcontrols.com

TEMPLATE NUMBER	REV	DATE
80-7360-1046-020	1	06/20