

	Door Leaf Width	OAL (Overall Length)	Dim A	Dim B	Dim D
D6021-36	36 (914)	74-1/4 (1886)	5-9/16 (141)	30-9/16 (776)	30-9/16 (776)
D6021-38	38 (965)	78-1/4 (1988)	7-9/16 (192)	32-9/16 (827)	32-9/16 (827)
D6021-40	40 (1016)	82-1/4 (2089)	9-9/16 (243)	34-9/16 (878)	34-9/16 (878)
D6021-42	42 (1067)	86-1/4 (2191)	11-9/16 (294)	36-9/16 (929)	36-9/16 (929)
D6021-44	44 (1118)	90-1/4 (2292)	13-9/16 (344)	38-9/16 (979)	38-9/16 (979)
D6021-46	46 (1168)	94-1/4 (2394)	15-9/16 (395)	40-9/16 (1030)	40-9/16 (1017)
D6021-48	48 (1219)	98-1/4 (2496)	17-9/16 (446)	42-9/16 (1081)	42-9/16 (1081)

Notes:

- Dimensions shown in inches / (mm) unless specified otherwise.
- Electrical requirements:
  - Power input of 120VAC, 5Amp minimum
  - Accessories circuit for activation to operator and low voltage
- For initial set up, doors must be un-latched and free to move
- For additional installation instructions, see instruction sheet 80-9360-1030-020. Visit [www.nortondoorcontrols.com](http://www.nortondoorcontrols.com)
- Refer to page 2 for proper handling of product

D6021 Series Template  
 shown on pairs of 36", 38", 40", 42", 44", 46", and 48" frames  
 shown with up to 5" Butt Hinges  
 Maximum reveal of 6-7/8" and  
 Maximum of 110 degrees of opening

Single Pull Side

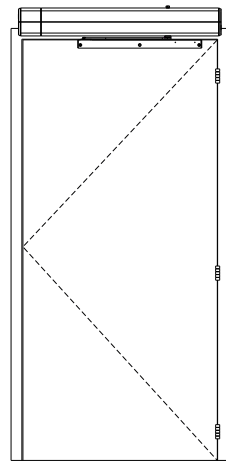

NOTE:  
- All illustrations on this page shown  
with 36" (914mm) wide doors

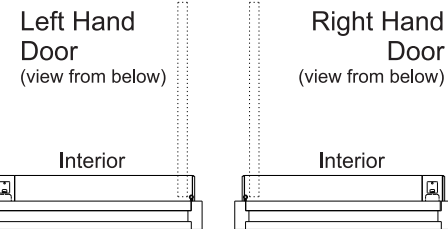

Double Door Pull Side

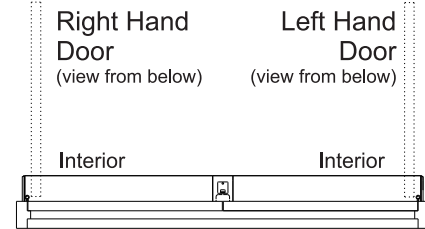
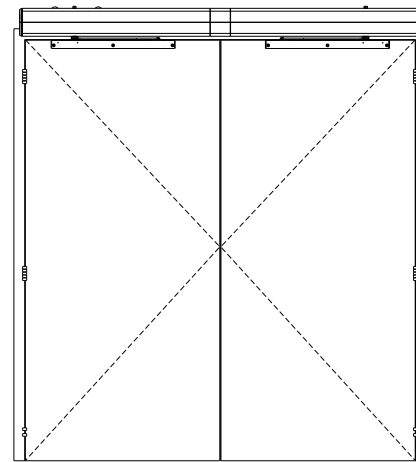

Double Door Double Egress Left Hand

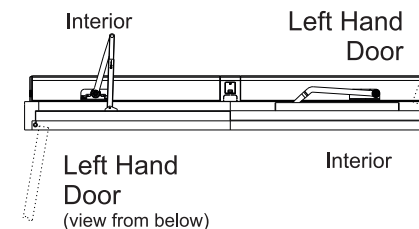
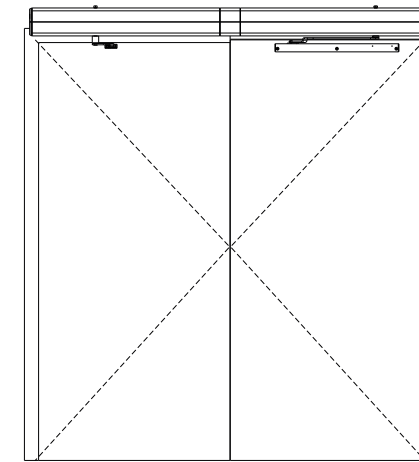

Single Push Side

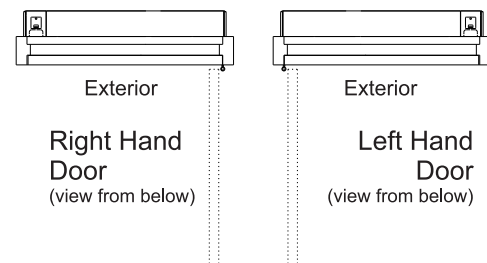
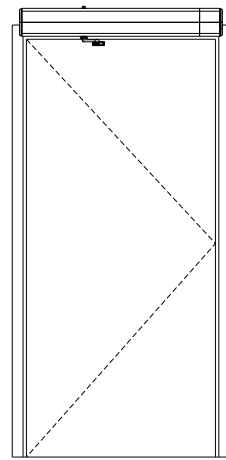

Double Door Push Side

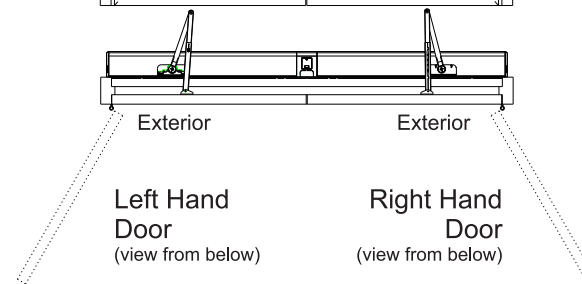
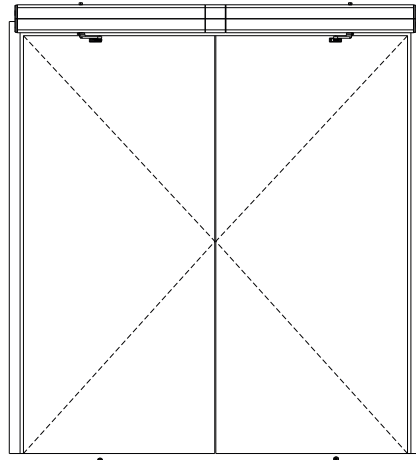

Double Door Double Egress Right Hand

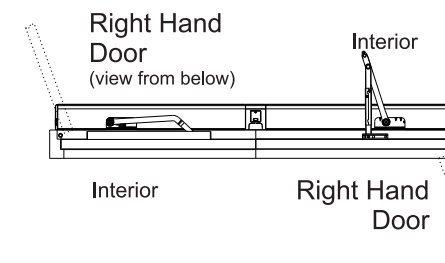
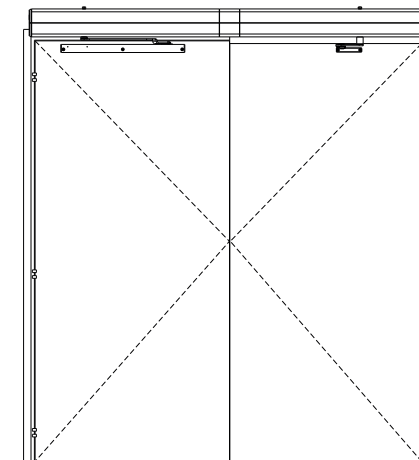

D6021 Series Template  
shown on pairs of 36", 38", 40", 42", 44", 46", and 48" frames  
shown with up to 5" Butt Hinges  
Maximum reveal of 6-7/8" and  
Maximum of 110 degrees of opening

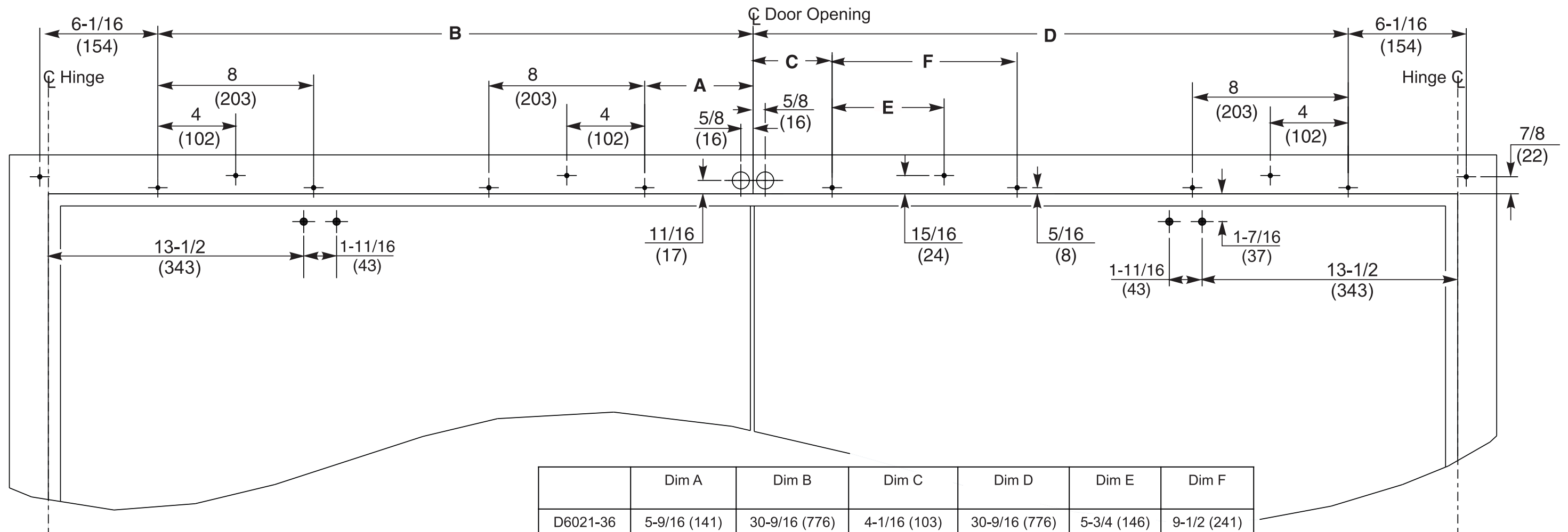

	Dim A	Dim B	Dim C	Dim D	Dim E	Dim F
D6021-36	5-9/16 (141)	30-9/16 (776)	4-1/16 (103)	30-9/16 (776)	5-3/4 (146)	9-1/2 (241)
D6021-38	7-9/16 (192)	32-9/16 (827)	4-1/16 (103)	32-9/16 (827)	7-3/4 (197)	11-1/2 (292)
D6021-40	9-9/16 (243)	34-9/16 (878)	9-9/16 (243)	34-9/16 (878)	4 (102)	8 (203)
D6021-42	11-9/16 (294)	36-9/16 (929)	10-1/16 (256)	36-9/16 (929)	5-3/4 (146)	9-1/2 (241)
D6021-44	13-9/16 (344)	38-9/16 (979)	12-1/16 (306)	38-9/16 (979)	5-3/4 (146)	9-1/2 (241)
D6021-46	15-9/16 (395)	40-9/16 (1030)	14-1/16 (356)	40-9/16 (1017)	5-3/4 (146)	9-1/2 (241)
D6021-48	17-9/16 (446)	42-9/16 (1081)	16-1/16 (408)	42-9/16 (1081)	5-3/4 (146)	9-1/2 (241)

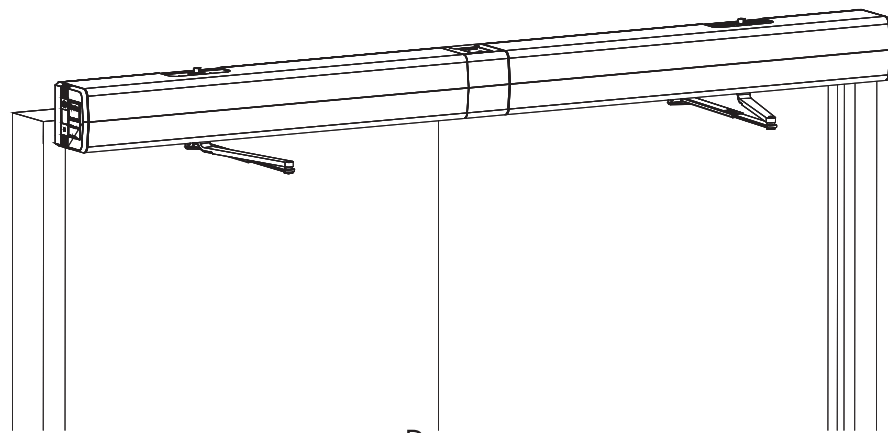

Doors  
Open  
Into Page

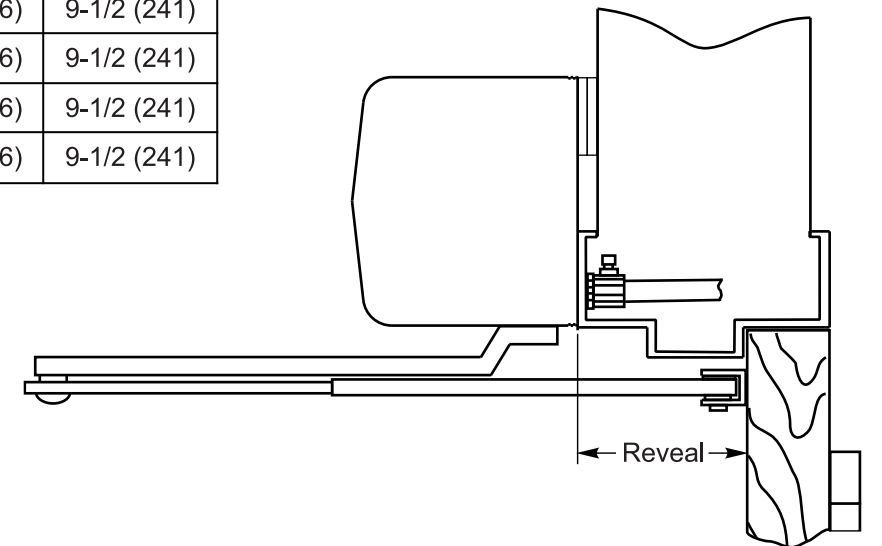

- Notes:
- Do not scale drawing.
  - Operator shown for push side double door application.
  - All dimensions are given in inches and millimeters.
  - Recommended thickness for reinforcements in hollow-metal doors and frames should provide a combined material thickness of .164 (4.2) MIN.
  - This template information based upon use of 5 (127) maximum width butt hinges or 3/4 (19) offset pivots.

**D6021 Series Template**  
 shown on pairs of 36", 38", 40", 42", 44", 46", and 48" frames  
 shown with up to 5" Butt Hinges  
 Maximum reveal of 6-7/8" and  
 Maximum of 110 degrees of opening