

	Door Leaf Width	OAL (Overall Length)	Dim A	Dim B	Dim D
D6031-36	36 (914)	74-1/4 (1886)	5-9/16 (141)	30-9/16 (776)	30-9/16 (776)
D6031-38	38 (965)	78-1/4 (1988)	7-9/16 (192)	32-9/16 (827)	32-9/16 (827)
D6031-40	40 (1016)	82-1/4 (2089)	9-9/16 (243)	34-9/16 (878)	34-9/16 (878)
D6031-42	42 (1067)	86-1/4 (2191)	11-9/16 (294)	36-9/16 (929)	36-9/16 (929)
D6031-44	44 (1118)	90-1/4 (2292)	13-9/16 (344)	38-9/16 (979)	38-9/16 (979)
D6031-46	46 (1168)	94-1/4 (2394)	15-9/16 (395)	40-9/16 (1030)	40-9/16 (1017)
D6031-48	48 (1219)	98-1/4 (2496)	17-9/16 (446)	42-9/16 (1081)	42-9/16 (1081)

Notes:

- Dimensions shown in inches / (mm) unless specified otherwise.
- Electrical requirements:
 - Power input of 120VAC, 5Amp minimum
 - Accessories circuit for activation to operator and low voltage
- For initial set up, doors must be un-latched and free to move
- For additional installation instructions, see instruction sheet 80-9360-1030-020. Visit www.nortondoorcontrols.com
- Refer to page 2 for proper handling of product

D6031 Series Template
 shown on pairs of 36", 38", 40", 42", 44", 46", and 48" frames
 shown with up to 5" Butt Hinges
 Maximum reveal of 6-7/8" and
 Maximum of 180 degrees of opening

Single Pull Side

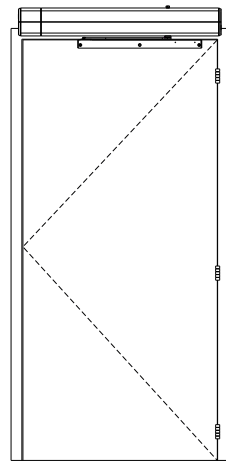

NOTE:
- All illustrations on this page shown
with 36" (914mm) wide doors

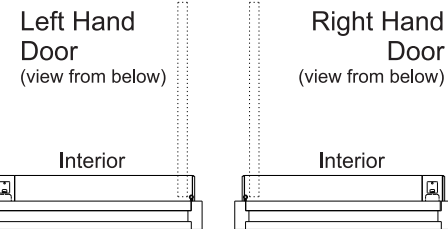

Double Door Pull Side

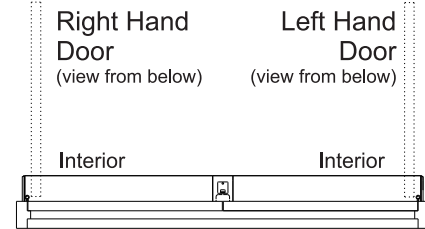
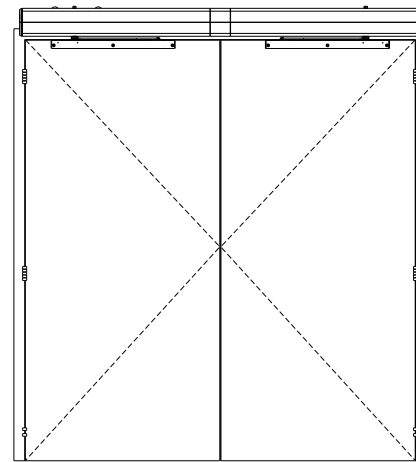

Double Door Double Egress Left Hand

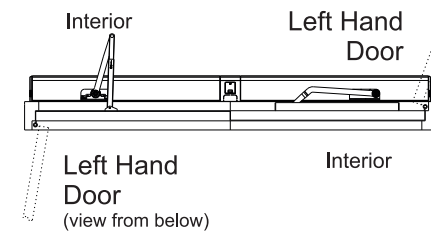
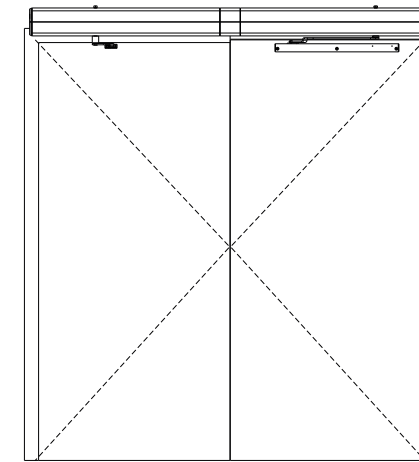

Single Push Side

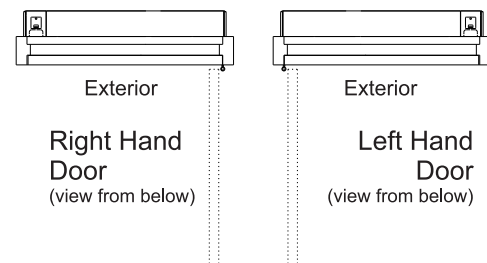
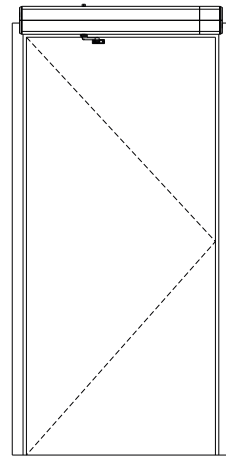

Double Door Push Side

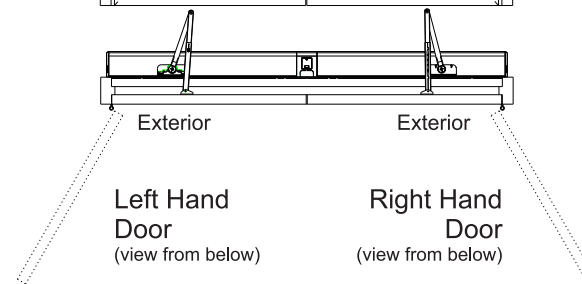
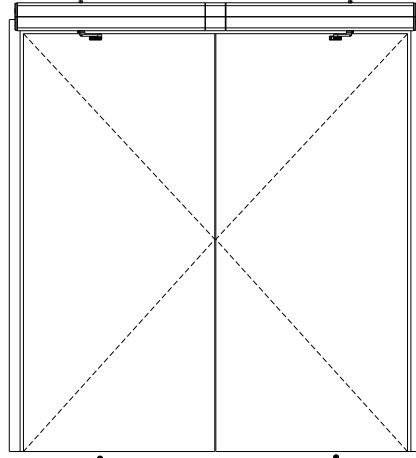

Double Door Double Egress Right Hand

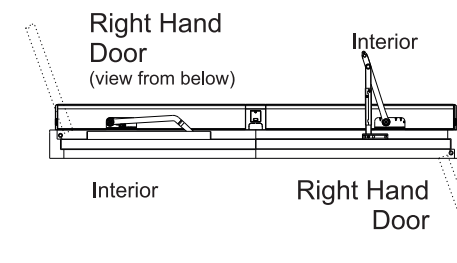
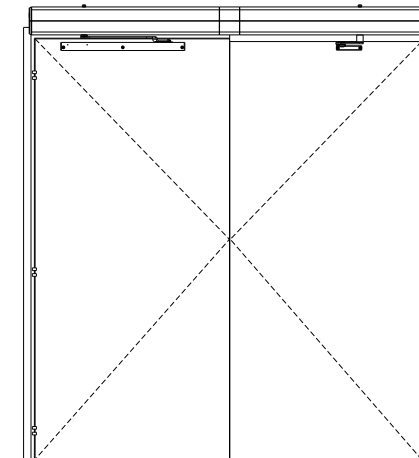

D6031 Series Template
shown on pairs of 36", 38", 40", 42", 44", 46", and 48" frames
shown with up to 5" Butt Hinges
Maximum reveal of 6-7/8" and
Maximum of 180 degrees of opening

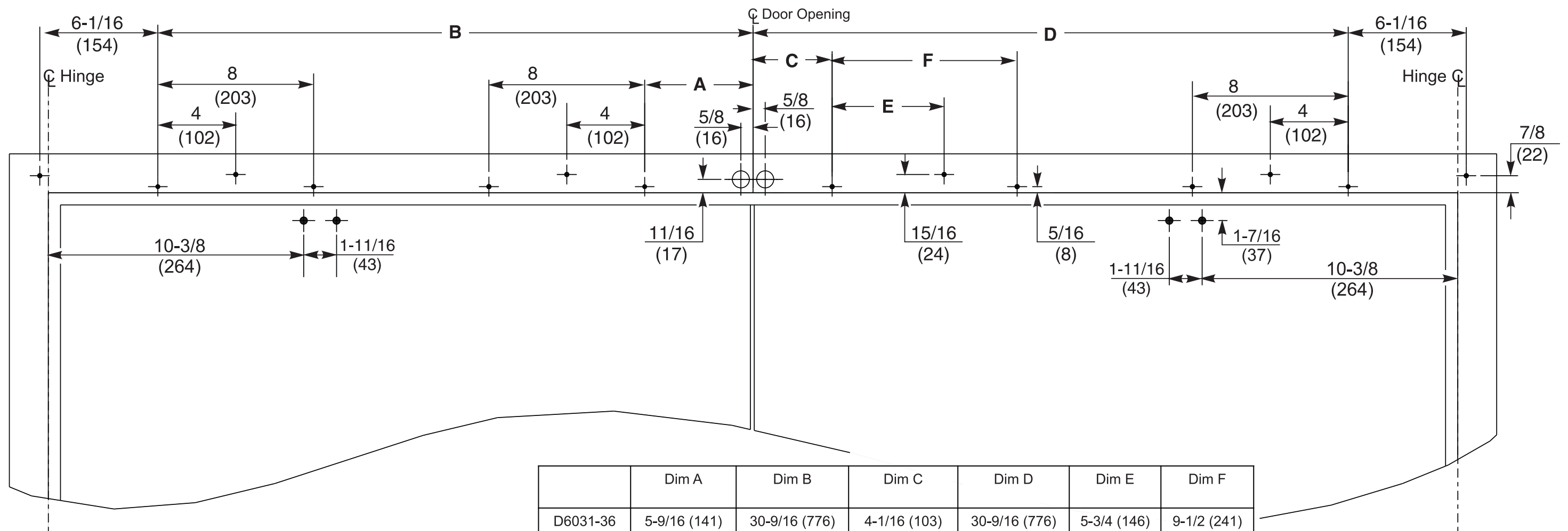

	Dim A	Dim B	Dim C	Dim D	Dim E	Dim F
D6031-36	5-9/16 (141)	30-9/16 (776)	4-1/16 (103)	30-9/16 (776)	5-3/4 (146)	9-1/2 (241)
D6031-38	7-9/16 (192)	32-9/16 (827)	4-1/16 (103)	32-9/16 (827)	7-3/4 (197)	11-1/2 (292)
D6031-40	9-9/16 (243)	34-9/16 (878)	9-9/16 (243)	34-9/16 (878)	4 (102)	8 (203)
D6031-42	11-9/16 (294)	36-9/16 (929)	10-1/16 (256)	36-9/16 (929)	5-3/4 (146)	9-1/2 (241)
D6031-44	13-9/16 (344)	38-9/16 (979)	12-1/16 (306)	38-9/16 (979)	5-3/4 (146)	9-1/2 (241)
D6031-46	15-9/16 (395)	40-9/16 (1030)	14-1/16 (356)	40-9/16 (1017)	5-3/4 (146)	9-1/2 (241)
D6031-48	17-9/16 (446)	42-9/16 (1081)	16-1/16 (408)	42-9/16 (1081)	5-3/4 (146)	9-1/2 (241)

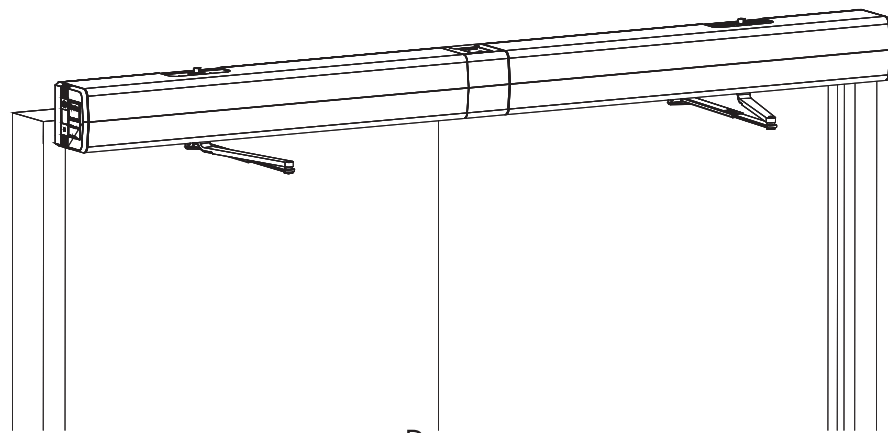

Doors
Open
Into Page

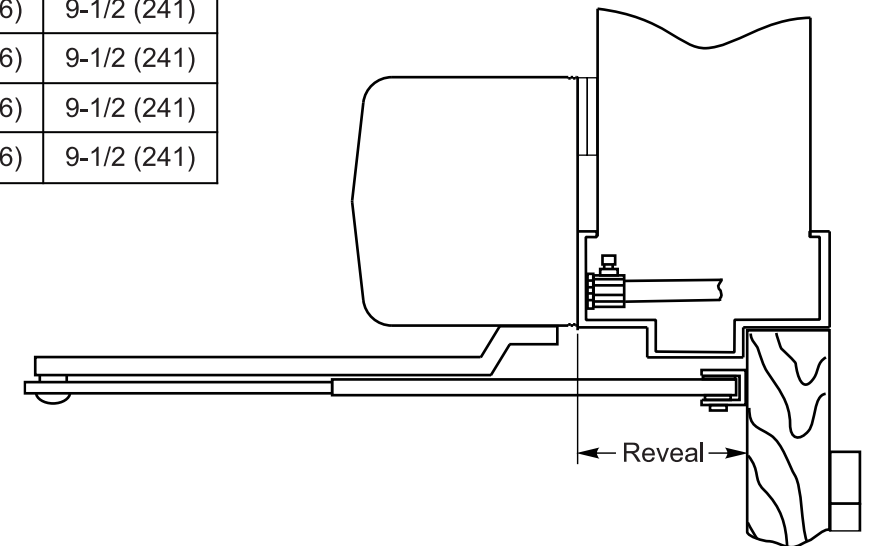

- Notes:
- Do not scale drawing.
 - Operator shown for push side double door application.
 - All dimensions are given in inches and millimeters.
 - Recommended thickness for reinforcements in hollow-metal doors and frames should provide a combined material thickness of .164 (4.2) MIN.
 - This template information based upon use of 5 (127) maximum width butt hinges or 3/4 (19) offset pivots.

D6031 Series Template
 shown on pairs of 36", 38", 40", 42", 44", 46", and 48" frames
 shown with up to 5" Butt Hinges
 Maximum reveal of 6-7/8" and
 Maximum of 180 degrees of opening