

# DCR SERIES

## R Series: 3/4" Cam Lock

**ANSI/BHMA Grade 1**  
**E07261 | E07271**  
**Woodwork Institute (WI)**  
**acknowledged product**

### SPECIFICATIONS

**Keying:** Can be keyed together with other R Series locks  
**Cylinder length:** DCR1 =1", DCR2=1-1/8", DCR3=1-3/8" and DCR4=1-3/4"  
**Rekeyable:** Easily rekeyable via cylinder retainer clip  
**ANSI/BHMA:** Passed ANSI/BHMA A156.11 Grade 1 performance requirements. Equivalent to E07261 / E07271.  
**US Patent Nos:** 5,038,589; 5,737,950  
**Body:** Zinc die cast  
**Cylinder:** Zinc die cast, pin tumbler  
**Standard function:** Key removable in locked or unlocked position.  
**Key retaining function:** Alternate key-retaining shifters are available separately for key removable in locked position only.  
**Cams:** 2 reversible cams work in all positions  
**Face:** 1" face covers splintering, no additional trim ring required  
**Finish:** 26D or US3  
**Packaged:** Packed 10 per box

**KEYING INFORMATION**  
**Keyway:** R Series (equivalent to CCL R1 system)  
**Keys:** Includes 2 keys per lock  
**Stock keying:** KD/KA - 5 pin standard  
**Stock KA#:** 4T21579, 4T37526  
**Masterkeyed:** 5 pin standard  
**Grand masterkeyed:** Available  
**Keyblank 5-pin:** KBR-5-NP (equivalent to CO106, 1003A)

### INCLUDED ACCESSORIES

See below.

### OPTIONAL ACCESSORIES

Alternate cams  
 Key retaining drawer cam shifter #DCNP-200-KR  
 Key retaining door cam shifter #DCNP-200-KDR

### DCR

**Keyway:** R Series, CCL R1 Keyway  
**Handing:** Includes 2 cams that work all handings (door or drawer)

### DCR SERIES FEATURES

- Non-handed—Field reversible locking positions: right-hand, left-hand, vertical and inverted
- Only 2 cams required—Ships with reversible straight and offset cams that meet requirements of all locking positions
- Easy rekeyability—Allows for a quick installation and increased productivity



- Anti-rotation plate—Eliminates lock rotation, prevents loosening of fixing nut, and provides additional security in particleboard applications

### AVAILABLE FINISHES

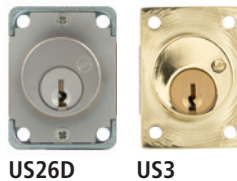

US26D

US3

### INCLUDED CAMS

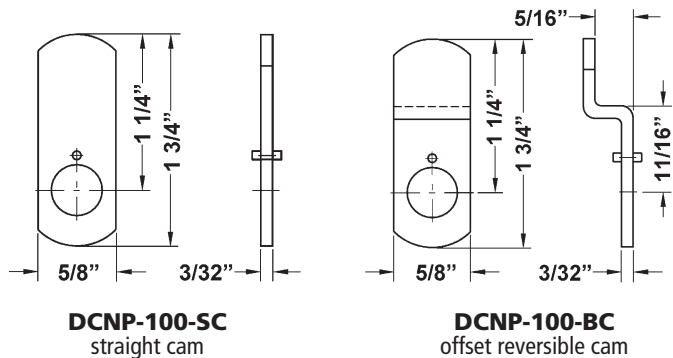

**WARNING:** This product can expose you to chemicals including chromium, which is known to the State of California to cause cancer and birth defects or other reproductive harm. For more information go to [www.P65Warnings.ca.gov](http://www.P65Warnings.ca.gov).



# DCR SERIES

## R Series: 3/4" Cam Lock

ANSI/BHMA Grade 1  
E07261 | E07271

Woodwork Institute (WI)  
acknowledged product

**OPTIONAL ACCESSORIES** - See our website for a complete list of optional components.

### Other Accessories

#### Key-retaining cam shifters

- For door function: DCNP-200-KDR
- For Drawer function: DCNP-200-KR

#### Washers

- Pronged wood washer: DCNP-SPW
- Self-adhesive clear plastic washer for mounting lock on glass: DCNP-GW

#### Finger Pull

- Finger pull: DCNP-300-FP

#### Number Plates

- T37DC-NP number plate

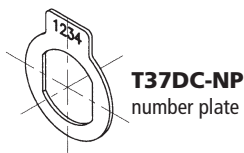

**DCNP-SPW**  
pronged wood washer



**DCNP-GW**  
self-adhesive clear plastic washer for mounting lock on glass

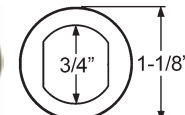

**DCNP-300-FP**

### TRB7 Series Trim Collars

Finish: US26D

**TRB7-18-26D**  
Spacer collar, 1/8"

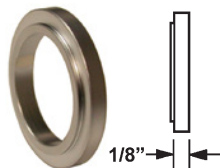

**TRB7-14-26D**  
Spacer collar, 1/4"

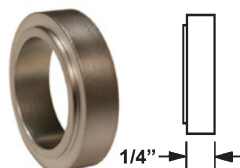

**TRB7-12-26D**  
Spacer collar, 1/2"

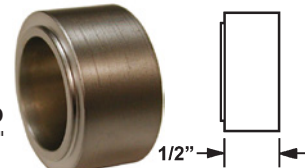

### Optional Cams

Note: Offset cams are reversible and can be used in either the inbent or outbent position.

Item	Description / Packed Each
DCNP-HD-875	7/8" long straight cam
DCNP-HD-1	1" long straight cam
DCNP-100-SC	1-1/4" long straight cam
DCNP-100-SC2	1-3/4" long straight cam
DCNP-100-SC3	1-1/2" long straight cam
DCNP-100-LC	3" long straight cam

Item	Description / Packed Each
DCNP-100-BC	1-1/4" long cam, 5/16" offset
DCNP-100-BC5	1-1/4" long cam, 1/2" offset
DCNP-100-HC1	1-1/2" long hook cam, 5/16" offset
DCNP-100-HD	1-7/16" long cam, 1/2" offset
DCNP-100-HD2	1-3/4" long cam, 5/16" offset
DCNP-100-HD3	1-1/8" long cam, 5/16" offset
DCNP-100-LBC	1-1/2" long cam, 5/16" offset

Item	Description / Packed Each
DCNP-100-B1	Straight cam with oval cutout
DCNP-100-B2	U-shaped cam
DCNP-100-B3	Straight hook cam
DCNP-100-WB	Short cam / 90° offset arm

>> Visit our website [www.olympuslock.com](http://www.olympuslock.com) for complete dimension and descriptions of available optional cams.

### DIMENSIONS | TYPICAL INSTALLATION

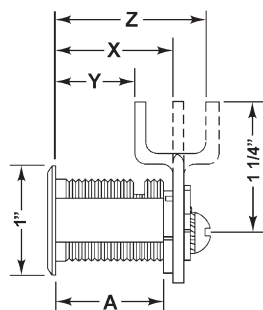

#### DIMENSIONS

	For Mat. Thickness	Straight Cam (X)	Inbent Cam (Y)	Outbent Cam (Z)	Cylinder Length (A)
DCR1	3/4"	1-1/16"	3/4"	1-3/8"	1"
DCR2	7/8"	1-3/16"	7/8"	1-1/2"	1-1/8"
DCR3	1-1/8"	1-7/16"	1-1/8"	1-3/4"	1-3/8"
DCR4	1-1/2"	1-13/16"	1-1/2"	2-1/8"	1-3/4"

#### MOUNTING CUTOUT

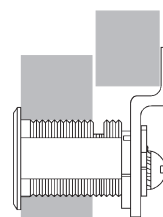
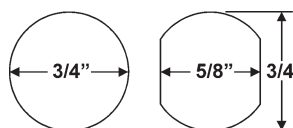

Overlay

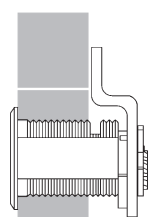

Flush

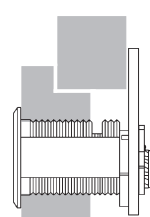

Lipped/Overlay