

DCN SERIES

N Series: 3/4" Cam Lock

ANSI/BHMA Grade 1
E07261 | E07271
Woodwork Institute (WI)
acknowledged product

SPECIFICATIONS

Keying: Can be keyed together with other N Series locks
Cylinder length: DCN1 =1", DCN2=1-1/8", DCN3=1-3/8" and DCN4=1-3/4"
Rekeyable: Easily rekeyable via cylinder retainer clip
ANSI/BHMA: Passed ANSI/BHMA A156.11 Grade 1 performance requirements. Equivalent to E07261 / E07271.
US Patent Nos: 5,038,589; 5,737,950
Body: Zinc die cast
Cylinder: Zinc die cast, pin tumbler
Standard function: Key removable in locked or unlocked position.
Key retaining function: Alternate key-retaining shifters are available separately for key removable in locked position only.
Cams: 2 reversible cams work in all positions
Face: 1" face covers splintering, no additional trimming required
Finish: 26D, US3, 10B or US19
Packaged: Packed 10 per box

KEYING INFORMATION

Keyway: N Series (equivalent to National D4291 4-pin or D4292 5-pin system)
Keys: Includes 2 keys per lock
Stock keying: KD/KA - 4 pin standard
Stock KA#: 101, 103, 107, 915, 51001, 51002, 51003, 51004
Masterkeyed: 5 pin standard
Grand masterkeyed: Available
Keyblank 4-pin: KBN-4-NP (equivalent to NA14, 1069L)
Keyblank 5-pin: KBN-5-NP (equivalent to NA12, 1069LA)
INCLUDED ACCESSORIES
 See page 2.
OPTIONAL ACCESSORIES
 Alternate cams
 Key retaining drawer cam shifter #DCNP-200-KR
 Key retaining door cam shifter #DCNP-200-KDR

DCN

Keyway: N Series, National Keyway
Handing: Includes 2 cams that work in all handings (door or drawer)

DCN SERIES FEATURES

- Non-handed—Field reversible locking positions: right-hand, left-hand, vertical and inverted
- Only 2 cams required—Ships with reversible straight and offset cams that meet requirements of all locking positions
- Easy rekeyability—Allows for a quick installation and increased productivity
- Anti-rotation plate—Eliminates lock rotation, prevents loosening of fixing nut, and provides additional security in particleboard applications



AVAILABLE FINISHES



INCLUDED CAMS

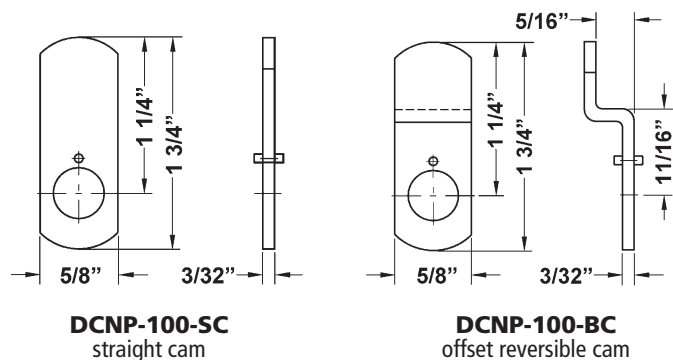

WARNING: This product can expose you to chemicals including chromium, which is known to the State of California to cause cancer and birth defects or other reproductive harm. For more information go to www.P65Warnings.ca.gov.



DCN SERIES

N Series: 3/4" Cam Lock

ANSI/BHMA Grade 1
E07261 | E07271

Woodwork Institute (WI)
acknowledged product

OPTIONAL ACCESSORIES - See our website for a complete list of optional components.

Other Accessories

Key-retaining cam shifters

- For door function: DCNP-200-KDR
- For Drawer function: DCNP-200-KR

Washers

- Pronged wood washer: DCNP-SPW
- Self-adhesive clear plastic washer for mounting lock on glass: DCNP-GW

Finger Pull

- Finger pull: DCNP-300-FP

Number Plates

- T37DC-NP number plate

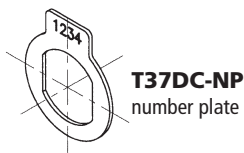

DCNP-SPW
pronged wood washer



DCNP-GW
self-adhesive clear plastic washer for mounting lock on glass

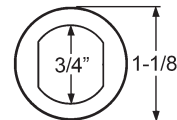

DCNP-300-FP

TRB7 Series Trim Collars

Finish: US26D

TRB7-18-26D
Spacer collar, 1/8"

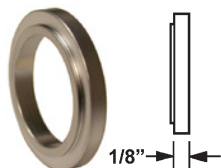

TRB7-14-26D
Spacer collar, 1/4"

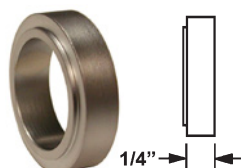

TRB7-12-26D
Spacer collar, 1/2"

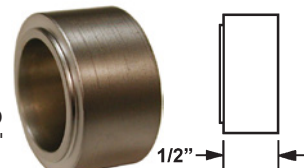

Optional Cams

Note: Offset cams are reversible and can be used in either the inbent or outbent position.

Item	Description / Packed Each
DCNP-HD-875	7/8" long straight cam
DCNP-HD-1	1" long straight cam
DCNP-100-SC	1-1/4" long straight cam
DCNP-100-SC2	1-3/4" long straight cam
DCNP-100-SC3	1-1/2" long straight cam
DCNP-100-LC	3" long straight cam

Item	Description / Packed Each
DCNP-100-BC	1-1/4" long cam, 5/16" offset
DCNP-100-BC5	1-1/4" long cam, 1/2" offset
DCNP-100-HC1	1-1/2" long hook cam, 5/16" offset
DCNP-100-HD	1-7/16" long cam, 1/2" offset
DCNP-100-HD2	1-3/4" long cam, 5/16" offset
DCNP-100-HD3	1-1/8" long cam, 5/16" offset
DCNP-100-LBC	1-1/2" long cam, 5/16" offset

Item	Description / Packed Each
DCNP-100-B1	Straight cam with oval cutout
DCNP-100-B2	U-shaped cam
DCNP-100-B3	Straight hook cam
DCNP-100-WB	Short cam / 90° offset arm

>> Visit our website www.olympuslock.com for complete dimension and descriptions of available optional cams.

DIMENSIONS | TYPICAL INSTALLATION

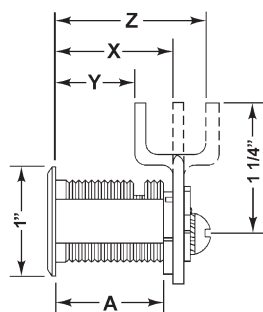

DIMENSIONS

	For Mat. Thickness	Straight Cam (X)	Inbent Cam (Y)	Outbent Cam (Z)	Cylinder Length (A)
DCN1	3/4"	1-1/16"	3/4"	1-3/8"	1"
DCN2	7/8"	1-3/16"	7/8"	1-1/2"	1-1/8"
DCN3	1-1/8"	1-7/16"	1-1/8"	1-3/4"	1-3/8"
DCN4	1-1/2"	1-13/16"	1-1/2"	2-1/8"	1-3/4"

MOUNTING CUTOUT

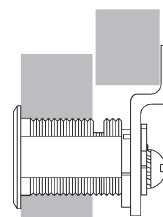
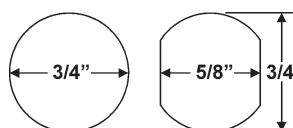

Overlay

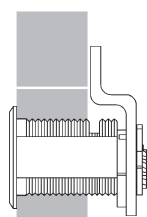

Flush

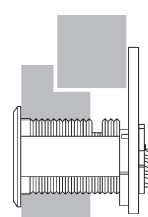

Lipped/Overlay