

SPACERS

For 1-1/8" diameter cabinet locks

SPECIFICATIONS

Material: White plastic

Function: To space the lock farther into the cabinet so that the lock face is flush with the face of the cabinet.

Thickness: 3/32", 1/4" or 1/2"

For use with: 725RD,
725RL, CR1125



WP725
1/8" thickness

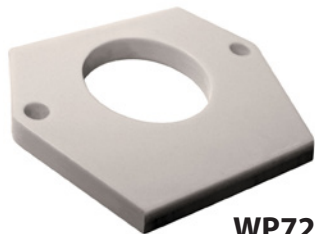

WP726
1/4" thickness

For use with: 700, 721, 754, 777, 800, 850,
854, 888, 931, 950, L72, L92

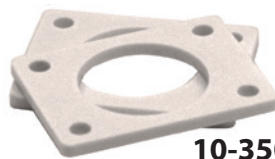

10-350
1/8" thickness

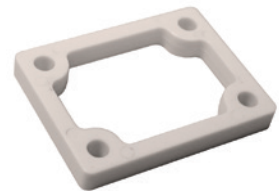

10-348
1/4" thickness



10-349
1/2" thickness

For use with: L78

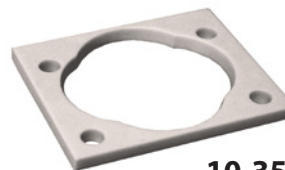

10-351
1/8" thickness

See back for product dimensions.



**OLYMPUS
LOCK**
INC.

SPACERS

For 1-1/8" diameter cabinet locks

DIMENSIONS

10-350

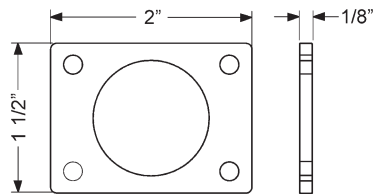

10-348

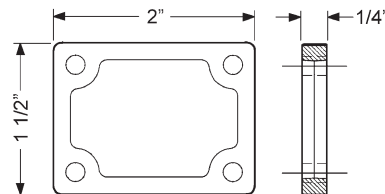

10-349

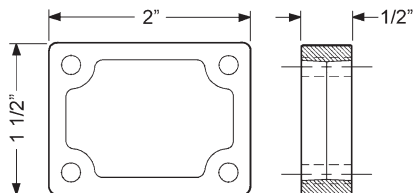

10-351

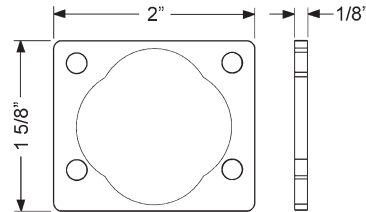

WP725

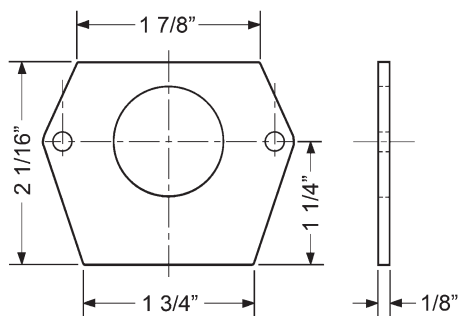

WP26

