

Pulse PRO



Features

Keypad

Red LED
Buzzer
Keypad test
Automatic DST
Battery compartment
Battery level test
Buzzer silencing function
12 function keys
Compatible with digital locks
Compatible with analog locks

Power

- 9V alkaline battery
- large battery box
- power supply

Locks

2 Masters
3 Managers
49 users
10 Time delay override users
Codes expiry
Time delay 1-99 minutes
Open window 1-19 minutes
Silent alarm
Remote disable opening
Remote time delay override
Door open alarm
Bolt status output
Penalty
Dallas Keys
Dual code mode
Audit trail with time and date
(up to 5500 events)
Pre-programmed configurations
(more than 80)
Fully configurable by keypad
Hotel mode
Master reset
Hardware reset
ERC – Emergency Rescue Code

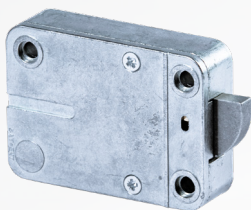

RotoBolt

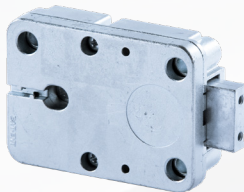

StraightBolt

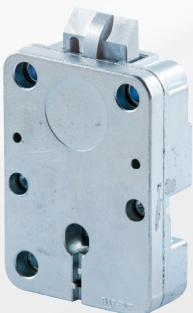

SpringBolt



MotorLock



Motor SpringBolt

Pulse PRO

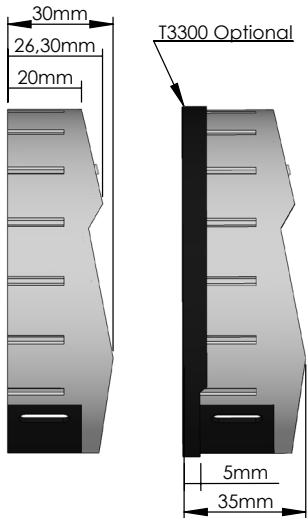
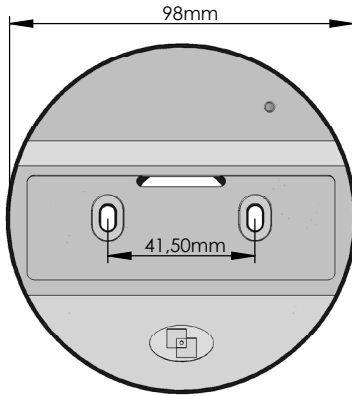

RotoBolt

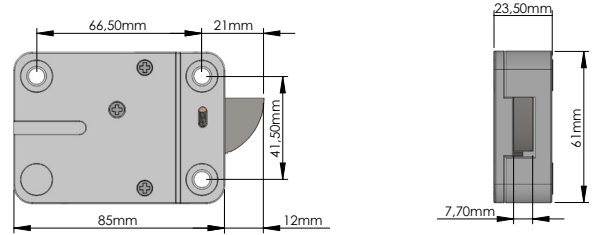

StraightBolt

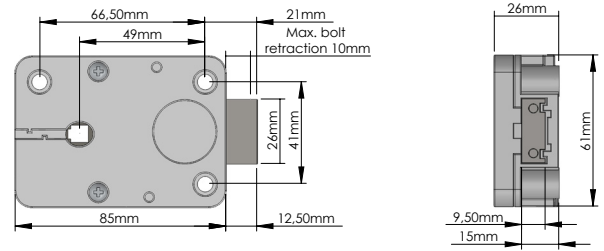

SpringBolt

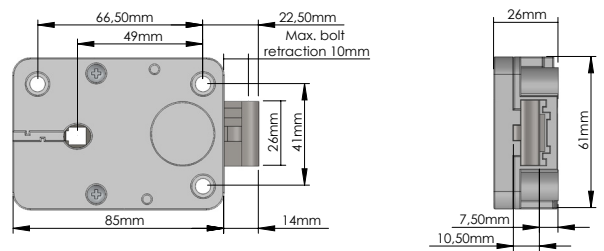

MotorLock

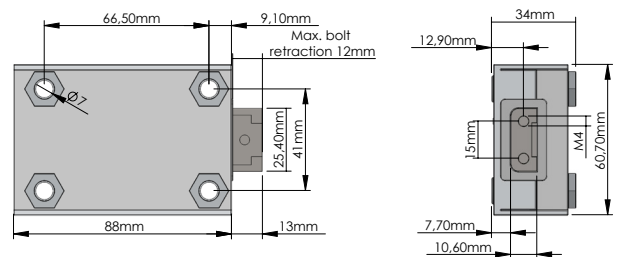

Motor SpringBolt

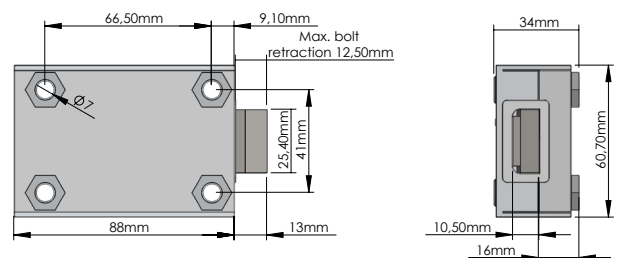

GLOBAL HEADQUARTERS

Tecnosicurezza
Via C. Battisti, 276
37057 S.Giovanni Lup.(VR)
ITALY
info@tecnosicurezza.it
www.tecnosicurezza.it

USA HEADQUARTERS

Tecnosicurezza
50, Thomas Lane
Versailles, KY 40383
USA
info@usatecno.com
www.usatecno.com

SPAIN HEADQUARTERS

Tecnosicurezza
C/Menor, 4 - Nave 10, Pol Ind. "La Miña"
28770 Colmenar Viejo
SPAIN
info@tecnosicurezza.es
www.tecnosicurezza.es