



Electric Strike Installation Instructions 2420 Series

ROFU Security International Corp.

6818 S 220th ST

Kent, WA 98032

(253) 922-1828

www.ROFU.com

OrderEntry@ROFU.com

2420 series of electric strikes are designed for use with cylindrical locksets and accommodate latchbolts up to 9/16" throw. The strikes can be configured to fail-safe or fail-secure on site.

Model	Latch Monitor	Endurance (Cycles)	Body Construction	Frame	Latch Throw
2420	—	250,000	Zinc Alloy	Hollow Metal	9/16" (15mm)
2420LM	●	250,000			

Operating Voltage	12/24VDC
Current Draw	300mA/12VDC, 150mA/24VDC
Operating Temperature	For indoor use: + 14°F to + 120°F (-10°C to + 49°C) For outdoor use: -31°F to +151°F (-35°C to + 66°C)
Humidity	0% to 85% Non-condensing
Latch Throw	9/16" (15mm) maximum
Keeper Width	1 7/16" (36mm)
Static Strength	1500 lbs (680Kg)
Dynamic Strength	70 ft-lbs

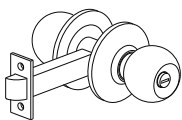
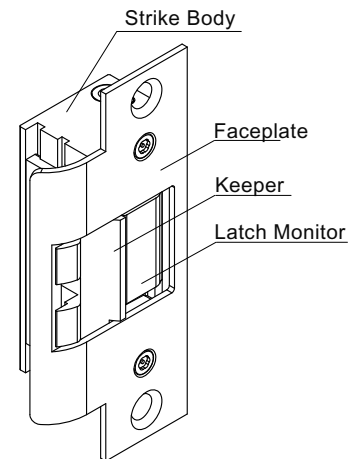
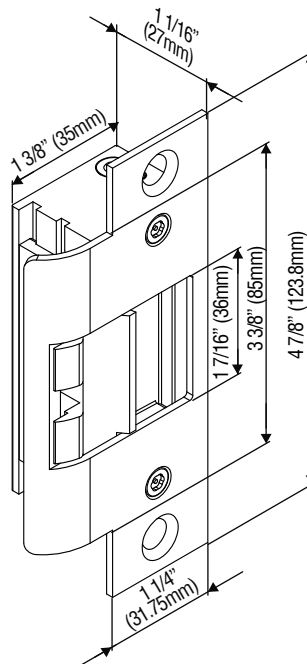

Cylindrical Knob Lockset

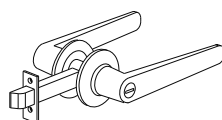

Cylindrical Lever Lockset

Wiring Diagrams

Dual Voltage (12V/24V)

For 12VDC Operation:

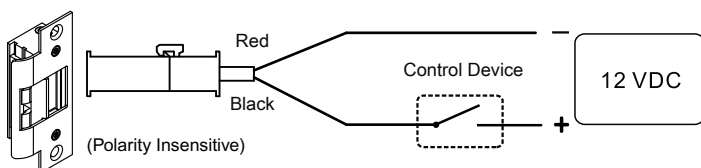

For 24VDC Operation:

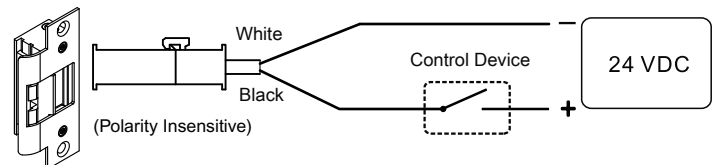

Installation on Wood and Hollow Metal Frame:

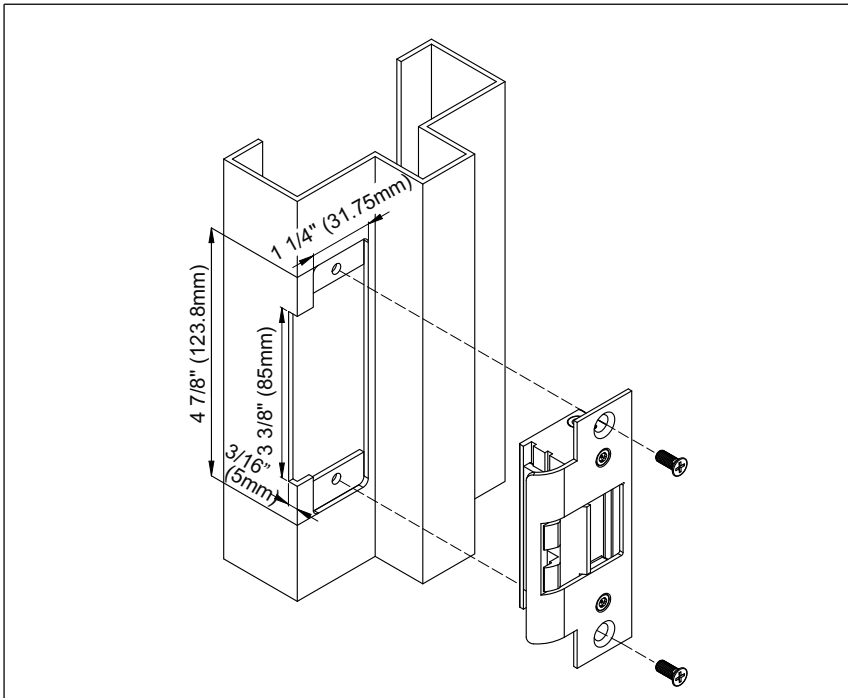

Installing the Crimp Connectors

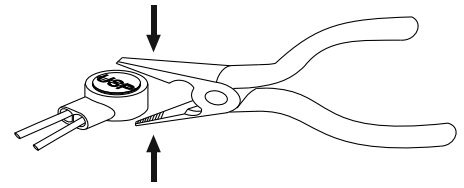

Place the wire inside the connector and use pliers to press down on the head of the connector evenly.

Fail-Safe / Fail-Secure Reversible

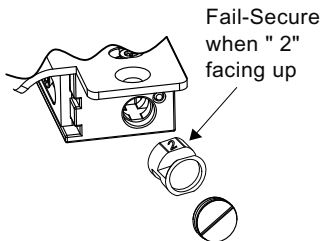

1. Remove the plug and take out the round screw.

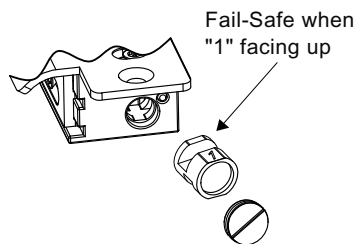

2. Reverse the round screw.

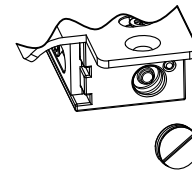

3. Put back the round screw and plug.

*Factory default setting is Fail-Secure.

Installation Steps

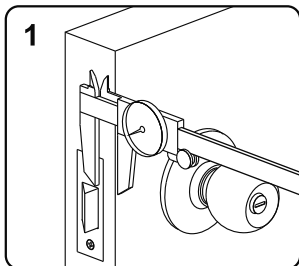

1 Measure the vertical and horizontal position of the latch bolt on the door leaf

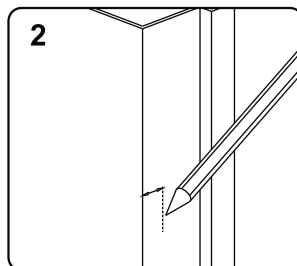

2 Mark the position of the latch bolt on the door jamb as shown in figure

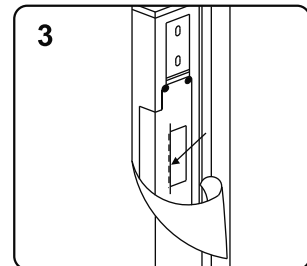

3 Align the installation template to the marked line

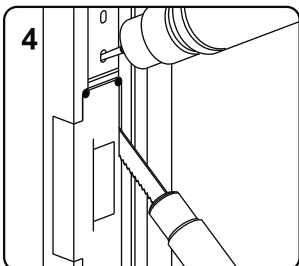

4 Drill and cut the frame according to the template

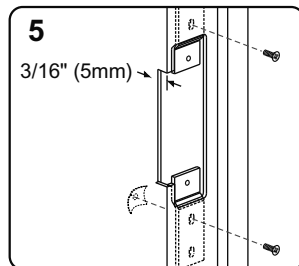

5 Install the mounting tabs

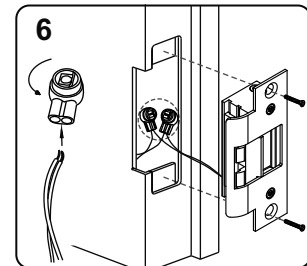

6 Connect to the power and test the electric strike before finally mounting the unit



Note

Please ensure that there is no back pressure on the keeper from the latch. As with most strikes this may cause the strike to bind and malfunction. It could also cause undo pressure on the solenoid and eventual failure of the strike.