



Installation Instructions ROFU Micro & Mini Magnetic Locks

8403M,F,S and 8406M

***See page 3 for model specifications**

ROFU 8403 Micro Series Maglock with 300lbs of holding power and is designed for the application of a compact, specialized electromagnetic lock provides a higher level of security. Easy installation in small cabinets, drawers, lockers or restricted spaces. 8403M-12 is recommended for medicine cabinet or sliding door mortise installation. 8403F-12 is recommended for cash drawer standard top or front mount installation. 8403S-12 is standard surface mount which mounts like a standard magnet using a supplied mounting plate (#20918) and it is recommended for cabinet or gun safes standard top installation.

ROFU 8406M Mini Series Maglock is a compact mortise maglock with 600lbs of holding power with a steel housing. It is ideal for securing sliding or swinging, manual or automatic doors. Its durability for high frequency use and the lock mortised in the frame and the armature in the door, it secures the door in a closed position. When power is cut the lock releases instantly.

8403S-12 Installations For Outswing Doors

Note: Installation varies but intended for exterior usage, mounting holes thru the front of the magnetic lock.

1

Template

Find the paper installation template included with the magnet (you will need this).

Fold it on the dotted line.

2

Frame

Door

Place the folded template in the proper position on the door/jamb and mark the holes you will cut for your magnet and armature plate. (Using tape will help)

3

Frame

Door

Drill the holes according to the marks you made.

(Check Twice! Drill Once!)

4 Armature Plate

The actual dimensions of the holes are illustrated below.

Hollow Metal Door

1/2" 5/16"

Solid Door

1 7/16" 5/16"

Drill a 5/16" (8mm) hole through the door for the armature side.

For the sexnut side (secure side), enlarge the hole to 1/2" (12.7mm) for the width of the sexnut.

On wood doors the depth of the sexnut is 1 7/16" (36mm).

5

Mounting plate #20918

Attach the mounting plate to the jamb with the included Philips screws. Then use the thru-bolts to tighten the magnet to the mounting plate.

6

Power

Outswing Door

Connect the power and test the unit. Insert the anti-tamper caps into the screw holes in the magnet.

Installing the Crimp Connectors

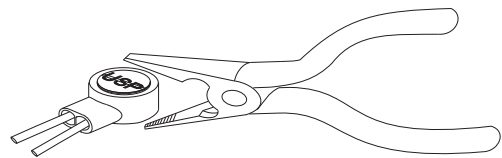

Place the wire inside the connector and use pliers to press down on the head of the connector evenly.

20925 Armature Bracket for 8406M Maglock







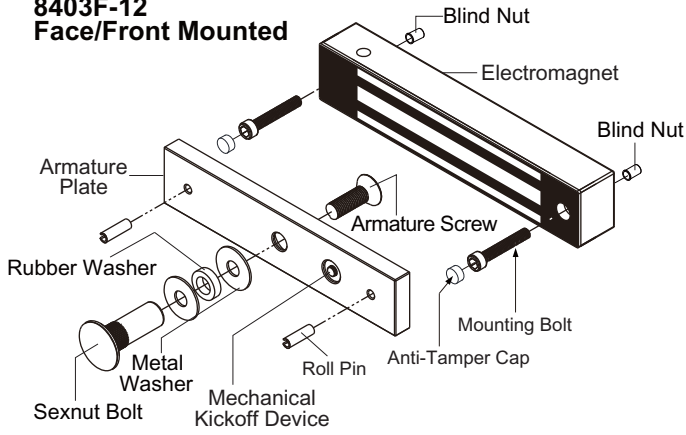

Mounting bracket #20925 is available for mounting armature plate to wood door.

Installation Diagram & Screw Pack Components

8403F-12 Face/Front Mounted





Screw Package Components:

Roll Pin	Hexagon Key (Allen Wrench)	Rubber Washer
		
5/32" x 5/8" x 2	5/32" and 3/16" x 1	3/8" x 9/16" x 3/16" x 1
Metal Washer	Anti-Tamper Cap	Thru-bolt (Hex Screw)
		
5/16" x 5/8" x 2	3/8" x 2	3/16" x 1 3/16" x 1
Blind Nut Assembly	Blind Nut	Allen Flat Head Screw
		
3/16" x 1 3/16" x 1	3/16" x 1	5/16" x 1" x 1

Installing Blind Nuts

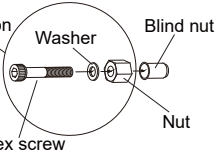
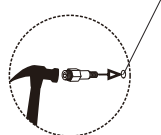
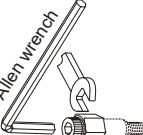
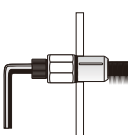





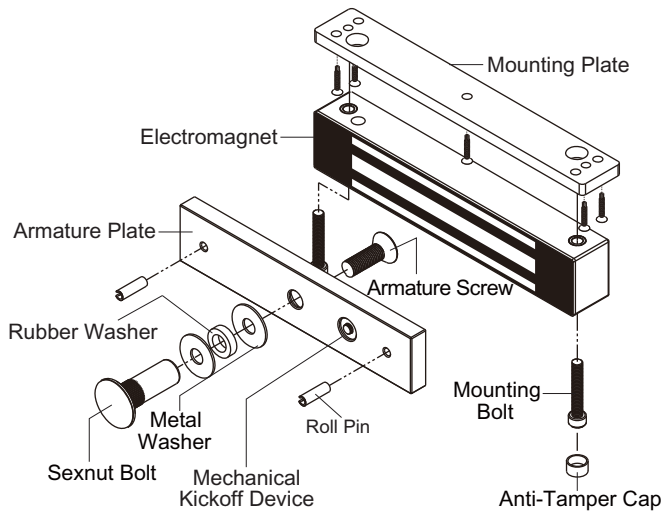

9.4mm holes for M6 Blind Nuts.
7mm holes for M5 Blind Nuts.

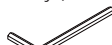
- 1** Blind Nut Assembly

- 2** Drill a 1/4" (7mm) hole and hammer the blind nut assembly into the hole.

- 3** Use a wrench or vice-grip to tightly hold the nut. Then use the included Allen wrench to slowly tighten the screw until it does not turn any further.

- 4** This compresses the blind nut so that it remains permanently fixed in the hole.

- 5** Remove the installation tool from the blind nut. Repeat step 2 through 4 for the other blind nut.

8403S-12 Surface/Standard Mounted



Screw Package Components:



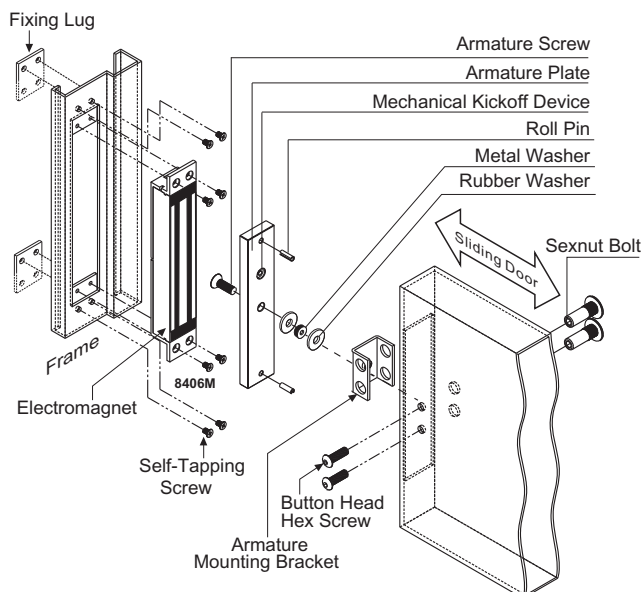

Roll Pin	Hexagon Key (Allen Wrench)	Rubber Washer
		
5/32" x 5/8" x 2	5/32" and 3/16" x 1	3/8" x 9/16" x 3/16" x 1
Phillips Flat Head Screw	Allen Flat Head Screw	Metal Washer
		
3/16" x 1" x 6	5/16" x 1" x 1	5/16" x 5/8" x 2
Anti-Tamper Cap	Thru-bolt (Hex Screw)	Sexnut Bolt
		
3/8" x 2	3/16" x 1" x 2	1/2" x 1 5/8" x 1

8403M-12 and 8406M for Sliding Doors





Screw Package Components:



For 8403M-12 & 8406M:

Roll Pin	Hexagon Key (Allen Wrench)	Rubber Washer
		
5/32" x 5/8" x 2	3/16" x 1	3/8" x 9/16" x 3/16" x 1
Allen Flat Head Screw	Button Head Hex Screw	
		
5/16" x 1" x 1	5/16" x 1" x 2	

For 8403M-12 Only:

Fixing Lug	Phillips Flat Head Screw
	
1 3/8" x 1 1/4" x 1/16" x 2	3/16" x 1/4" x 8

For 8406M Only:

Fixing Lug	Phillips Flat Head Screw	Metal Washer
		
1 5/8" x 1 1/2" x 2	3/16" x 5/16" x 10	5/16" x 7/8" x 2

Specifications

Model	8403F-12	8403S-12	8403M-12	8406M	
Holding Force	300lbs	300 lbs	300 lbs	600lbs	
Operating Voltage	12VDC	12VDC	12 VDC	12/24VDC	
Current Draw	300mA/12VDC, 260mA/24VDC	300mA/12VDC, 260mA/24VDC	300mA/12VDC, 260mA/24VDC	500mA/12VDC, 250mA/24VDC	
Operating Temperature	14°F~131°F (-10°C~55°C)				
Dimensions	Magnet	6 11/16"(L) x 1 1/4"(H) x 15/16"(W) (170 x 32 x 23.7mm)	6 11/16"(L) x 1 1/4"(H) x 15/16"(W) (170x 32x 23.7mm)	7 7/8"(L) x 1 1/4"(H) x 15/16"(W) (200 x 32 x 24mm)	9 1/16"(L) x 1 1/2"(H) x 1 1/16"(W) (230 x 38 x 27mm)
	Armature Plate	6"(L) x 1 1/4"(H) x 3/8"(W) (152 x 32 x 10mm)	6"(L) x 1 1/4"(H) x 3/8"(W) (152 x 32 x 10mm)	6"(L) x 1 1/4"(H) x 3/8"(W) (152 x 32 x 10mm)	7 1/4"(L) x 1 1/2"(H) x 1/2"(W) (185 x 38 x 12mm)
Frame	Wood, Hollow Metal				
Finish	US32D Brushed Stainless Steel			US28 Satin Aluminum	
Installation	Indoor use, Face/Front mounted	Indoor use, Surface/Standard mounted	Indoor use, Mortise mounted, For sliding doors	Indoor use, Mortise mounted, For sliding doors	

Model Changes to ROFU Special Micro & Mini Magnetic Locks

Wiring Diagram for 8406M

8 4 0 X X - 12

12 VDC

M = Mortise mount
S = Surface/Standard mount
F = Face/Front mount

Holding Force: 3 = 300lbs (Micro)
6 = 600lbs (Mini)

4 = Special Micro & Mini Magnetic Locks

MAGLOCK SERIES

12VDC operation

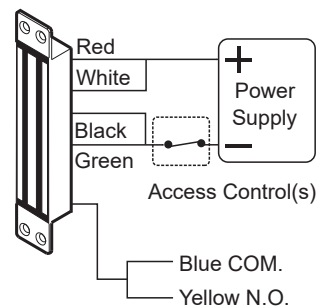

24VDC operation

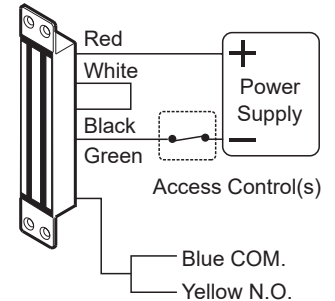

Applications

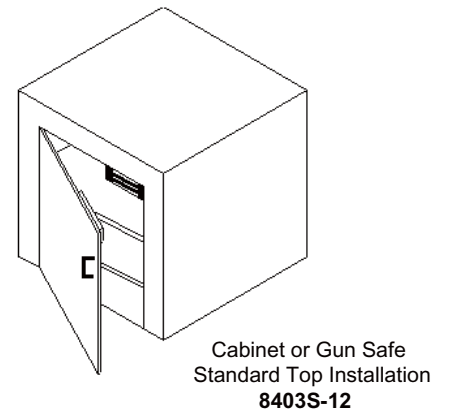
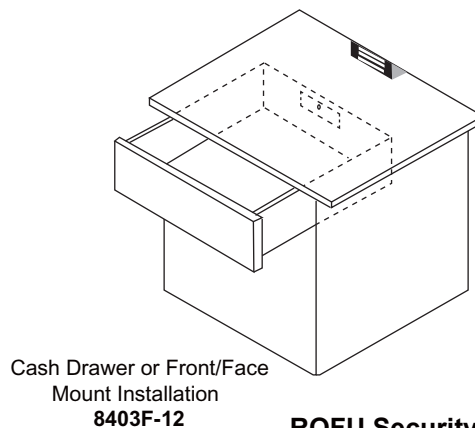
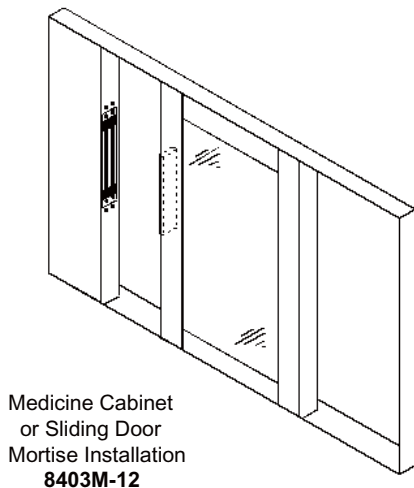

ROFU Security International Corp.

6818 S 220th ST
Kent, WA 98032
(253) 922-1828

www.ROFU.com

OrderEntry@ROFU.com