

Template

IMPORTANT

Specify Wood or Machine Screws for Jamb
Specify Wood or Machine Screws for Door or Gate
Specify thickness of Door or Gate

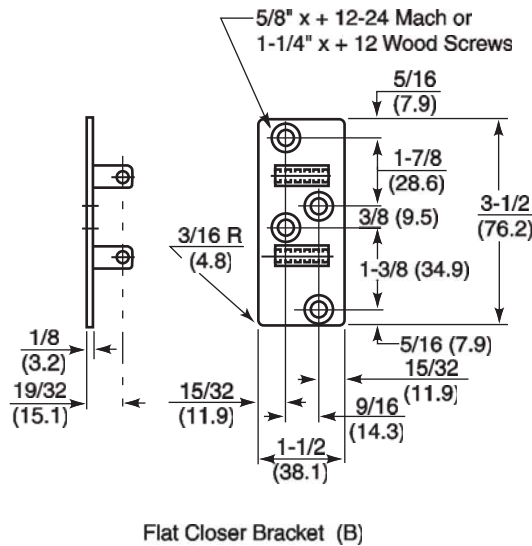
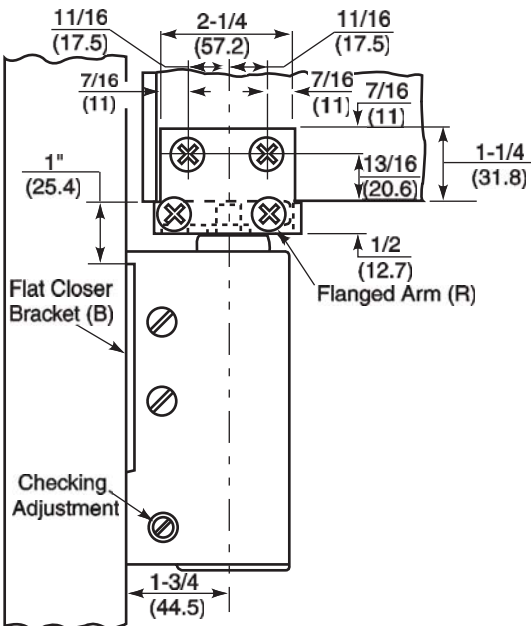
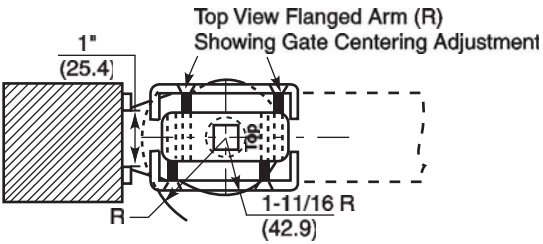
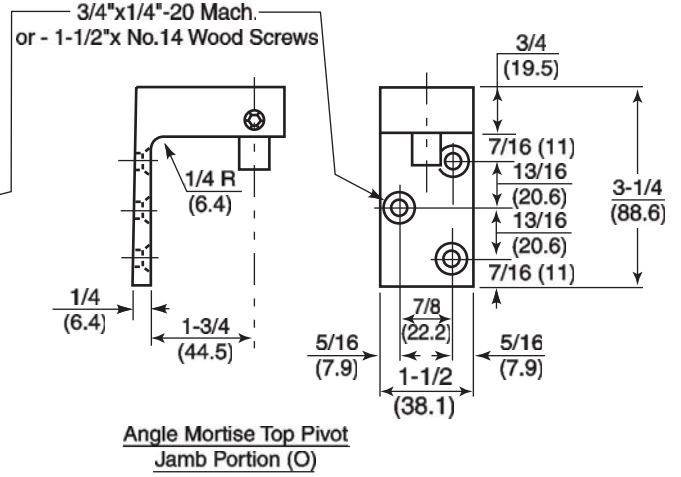
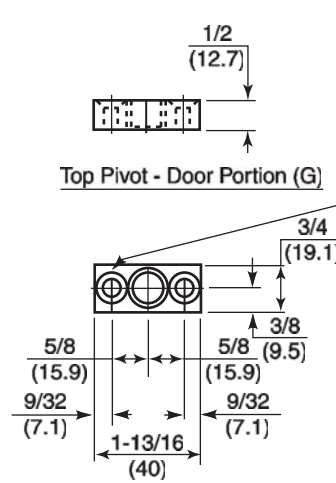
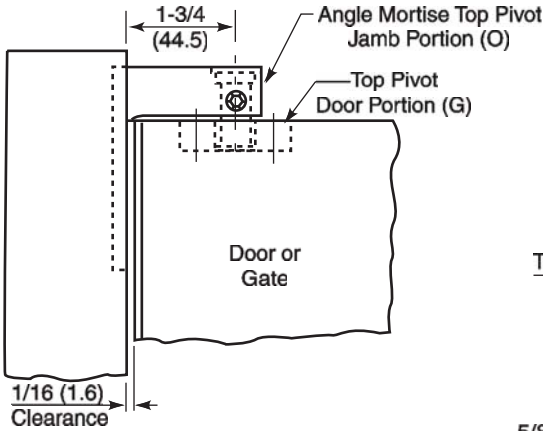

DO NOT SCALE DRAWING
Dimensions given in inches (mm).

How To Determine Hand of Door

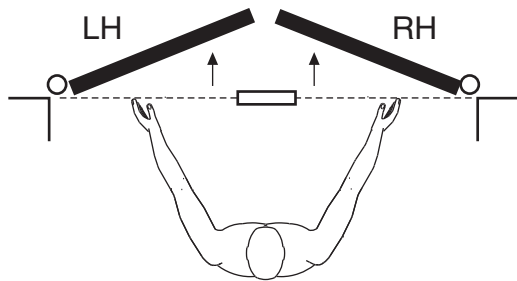

Face a door swinging open away from you. If it opens to the right, it is right hand. If it opens to the left, it is left hand.

Installation Instructions

- Step 1.** Secure the flat Check Bracket "B" on the jamb or gate post.
- Step 2.** If Angle Surface Top Pivot "N" is used, mount to the surface of the jamb or gate post as shown.
- Step 3.** Flanged Arm "R" may be placed on the Closer Spindle in a position to hold the door open at 90° or to close the door. The four screws at the bottom of the flanges are for use in centering a double acting door and for pulling a single acting door toward the door stop to insure full closing.
- Step 4.** THE ARM CLAMPING SCREWS MUST BE TIGHT. Use wrench supplied.
- Step 5.** The door is then hung, the last operation being to screw the arm tightly to the bottom of the door.

Double Acting Doors: If the door does not center properly in the opening, LOOSEN THE ARM CLAMPING SCREW until the door swings free on the knurled bushing on the Closer Spindle. Move the door to the desired position and TIGHTEN THE CLAMPING SCREWS. (BE SURE THEY ARE VERY TIGHT.)

Single Acting Door: Adjust the closing speed of the door with the valve located near the bottom of the Closer to allow the door to close quickly without slamming.

Double Acting Door: Adjust the valve so door is dampened (no "flip-flop") at the closed position.

