

*** For Wiring
See Note 3**

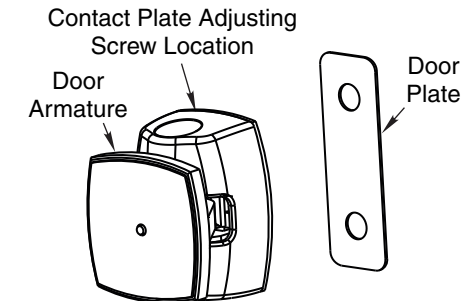
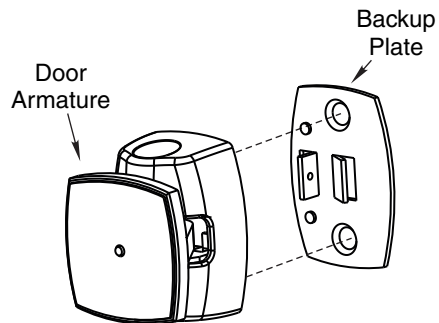
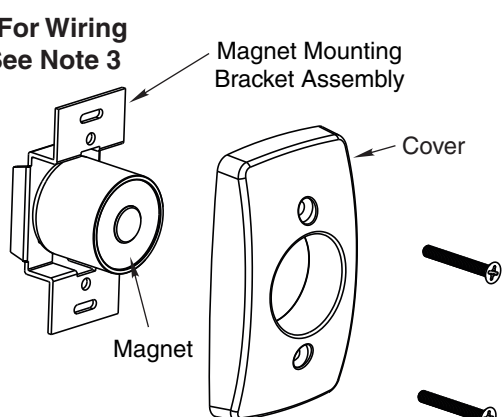

CAUTION: Nicks and scratches on the magnet surface will lessen or diminish the holding force of the magnet. Do not remove protective cap, if present, until last steps of installation.

Surface Applied Concealed Mounting
Recommended for Solid Wood Doors Only

Thru Bolt Mounting
Recommended for Hollow Metal, Hollow Core or Composite Type Wood Doors

5/32" x 3/8" (4 x 9.5) Slot for 2" x 4" (51 x 102) Electric Box (2 Places)

10-32 x 1-1/2 Self Tapping

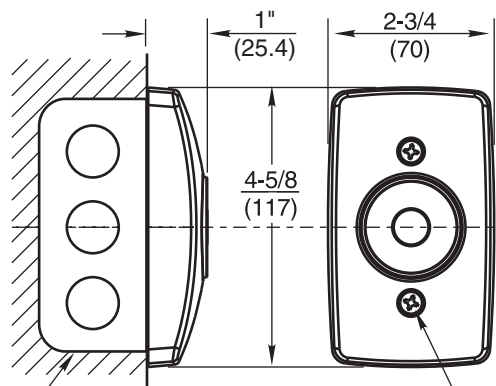
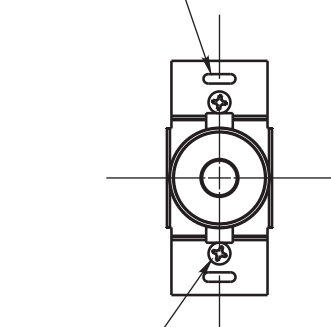

10-32 Self-tapping Screw (2 Places)
2" x 4" x 1-1/2" (51 x 102 x 38) Single Gang Electric Box (by others)

10-32 x 1-1/2" Flat Head Self-Tapping Screws (2 Places)

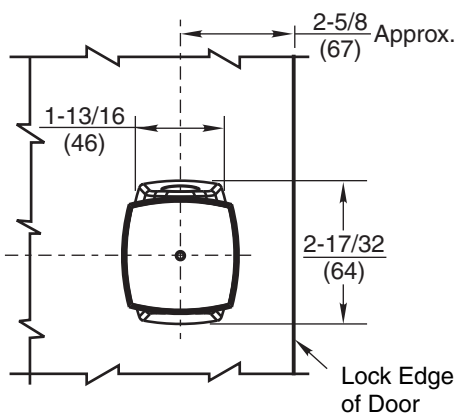

Lock Edge of Door

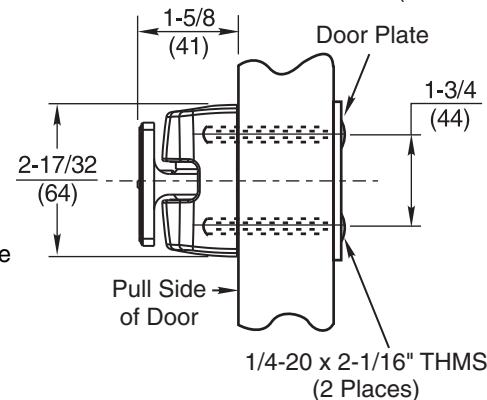
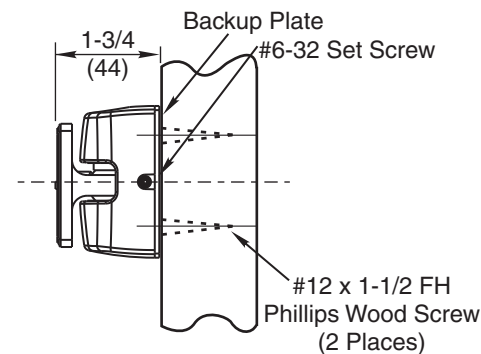

Notes:

1. Do not scale drawing.
2. Total projection 2-5/8" (67mm). (Includes electromagnet and armature assembly.)
3. Non-tri voltage magnets have two non-polarized wires to be connected. Tri voltage magnets are connected using a terminal strip on back of magnet. One wire in common and one wire in the appropriate voltage terminal (non-polarized). Ground assembly to earth ground per state and local regulations.
4. See step 1 of sheet 2 for Electric Box location. Anchor Electric Box to withstand a

5. minimum 50 lb. pull. Electric Box shown installed in a vertical position.
5. Door closing mechanism should have a 3 lb. closing force at the degree of door opening where door armature and electromagnet engage.
6. Door hardware must not project more than 2-1/4" (57mm) on pull side of door.
7. Mounting of Electric Box should be reinforced to withstand shock of door opening. Failure to do so will cause box anchors to work loose.
8. All dimensions given in inches (mm).
9. See sheet 2 for more details.

997M Door Release

RIXSON
ASSA ABLOY

www.rixson.com

SHEET	TEMPLATE NUMBER	Rev
1 of 2	DR100265	1

1. Use table to locate Electric Box.

2. Determine door width (Dim "B"). Measure pivot centerline to wall (Dim. "A"). Find dimension "C" in table.

Example: Pivot centerline to wall ("A") = 10" (254mm)
 Door Width ("B") = 36" (914mm)
 Electric Box Centerline ("C") = 33" (838mm)

3. If "A" or "B" falls between the numbers listed in table, allow for difference.

Example: Pivot centerline to wall ("A") = 7" (178mm)
 Door Width ("B") = 36" (914mm)
 Electric Box Centerline ("C") = 33-5/8" (854mm)

4. If dimensions "A" and "B" intersect in shaded area of table DO NOT INSTALL ELECTRIC BOX. The degree of door opening will not permit proper alignment between armature and wall magnet.

5. Height to be determined by others. Suggested height is 2' to 4' (610mm to 1219mm) from floor and/or not over 6' (1829mm).

6. Check degree of door opening in table and coordinate with door closers and other door hardware.

Location of Electric Box

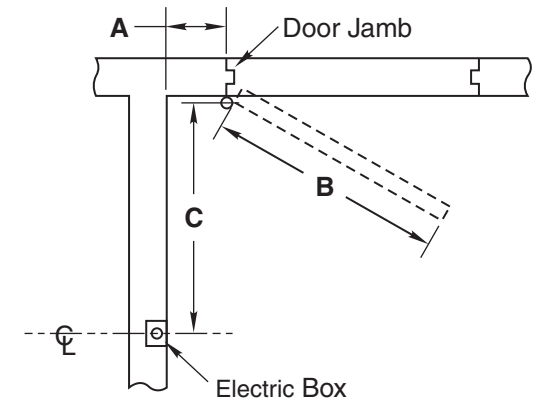

"A" – Pivot Centerline to Wall
 "B" – Door Width
 "C" – Pivot Centerline to Electric Box Centerline

Dim. "A"	Door Width "B"																					
	28" (711)		30" (762)		32" (813)		34" (864)		36" (914)		38" (965)		40" (1016)		42" (1067)		44" (1118)		46" (1168)		48" (1219)	
	"C"	Deg.	"C"	Deg.	"C"	Deg.	"C"	Deg.	"C"	Deg.	"C"	Deg.	"C"	Deg.	"C"	Deg.	"C"	Deg.	"C"	Deg.	"C"	Deg.
2" (51)	26" (660)	92°	28" (711)	92°	29-7/8 (759)	92°	32" (813)	93°	34-1/8 (867)	93°	36" (914)	92°	37-7/8 (962)	92°	40" (1016)	93°	42" (1067)	93°	43-7/8 (1114)	92°	45-5/8 (1159)	92°
4" (102)	26" (660)	97°	28" (711)	96°	29-7/8 (759)	96°	32" (813)	95°	34-1/8 (867)	95°	36" (914)	95°	37-7/8 (962)	95°	40" (1016)	95°	42" (1067)	95°	43-7/8 (1114)	94°	45-5/8 (1159)	94°
6" (152)	25-5/8 (651)	102°	27-5/8 (702)	101°	29-5/8 (752)	101°	31-3/4 (806)	99°	33-3/4 (857)	98°	35-3/4 (908)	97°	37-3/4 (959)	97°	39-7/8 (1012)	97°	41-7/8 (1063)	97°	43-3/4 (1111)	97°	45-1/2 (1155)	97°
8" (203)	25-1/8 (638)	106°	27-1/4 (692)	105°	29-1/4 (743)	104°	31-3/8 (797)	103°	33-1/2 (851)	102°	35-1/2 (902)	101°	37-3/8 (949)	101°	39-1/2 (1003)	101°	41-1/2 (1054)	101°	43-3/8 (1102)	100°	45-1/4 (1149)	99°
							31 (787)	105°	33" (838)	106°	35" (889)	105°	37" (940)	104°	39-1/8 (994)	104°	41-1/8 (1045)	104°	43-1/8 (1095)	103°	45 (1143)	102°
																			42-5/8 (1082)	105°	44-1/2 (1130)	104°

Dimensions given in inches (mm).

997M Door Release Location Sheet

RIXSON

ASSA ABLOY

www.rixson.com

SHEET	TEMPLATE NUMBER	Rev
2 of 2	DR100265	1