

Architectural Door Accessories

ASSA ABLOY

VRT24/VRT24C for Corbin Russwin ED5200 Series Exit Devices

The global leader in
door opening solutions

Complete this form and email to: orders.rockwood@assaabloy.com / or fax to: 800-922-9212

Customer Information

Company Name: _____ Date: _____
 Account #: _____ Phone/Fax: _____ / _____
 Email: _____ PO #: _____ Line #: _____

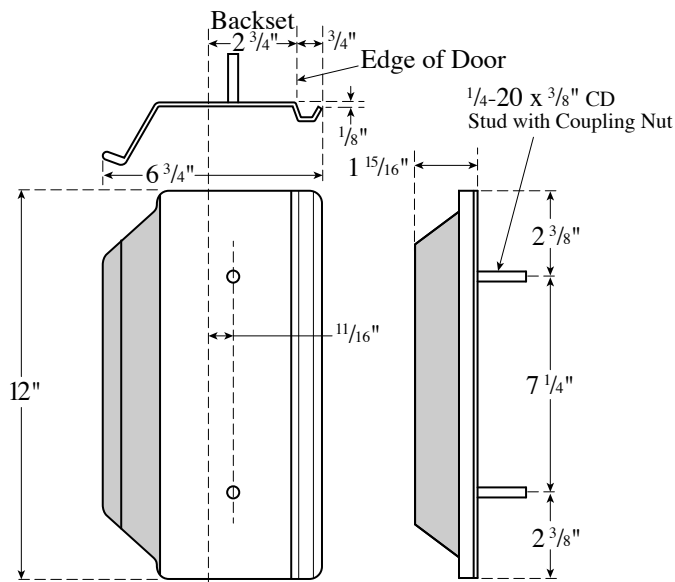

LHR: QTY _____ Finish _____

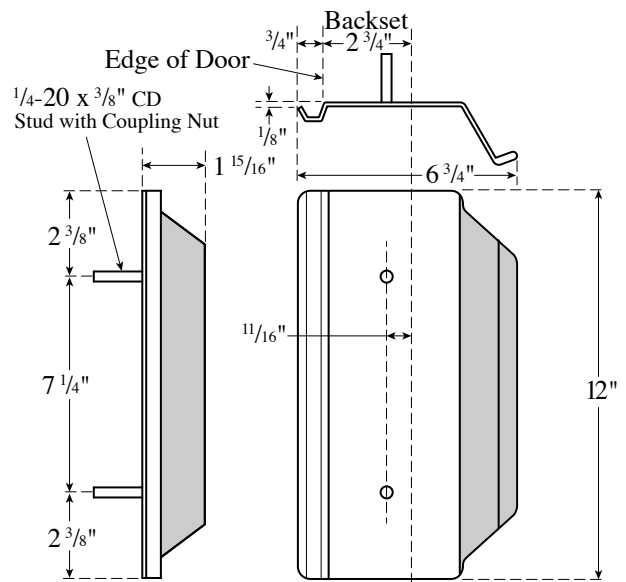

RHR: QTY _____ Finish _____

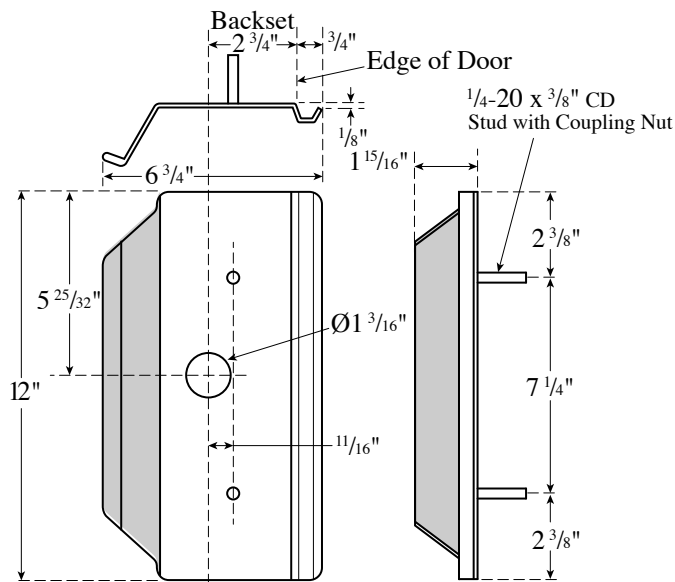

LHR: QTY _____ Finish _____

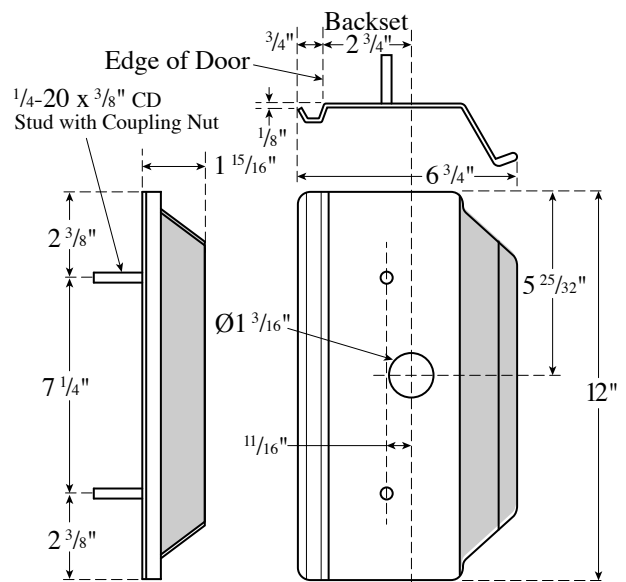

RHR: QTY _____ Finish _____

Note: If custom dimension please provide further information.

300 Main Street
 Rockwood, Pennsylvania 15557
 P: 800.458.2424 | F: 800.922.9212
www.assaabloydooraccessories.us | orders.rockwood@assaabloy.com

Copyright © 2018, ASSA ABLOY Accessories and Door Controls Group, Inc. All rights reserved. Reproduction in whole or in part without the express written permission of ASSA ABLOY Accessories and Door Controls Group, Inc. is prohibited.