

Architectural Door Accessories

ASSA ABLOY

VRT24/VRT24C for Precision 2100A Series Exit Devices

The global leader in
door opening solutions

Complete this form and email to: orders.rockwood@assaabloy.com / or fax to: 800-922-9212

Customer Information

Company Name: _____ Date: _____

Account #: _____ Phone/Fax: _____ / _____

Email: _____ PO #: _____ Line #: _____

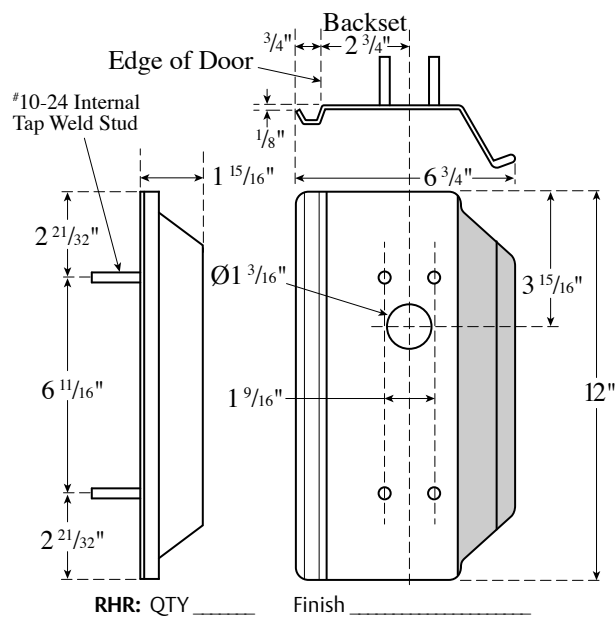
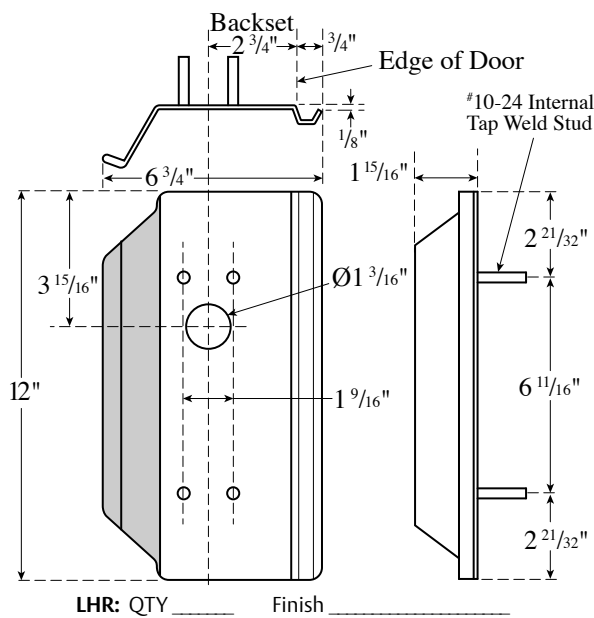
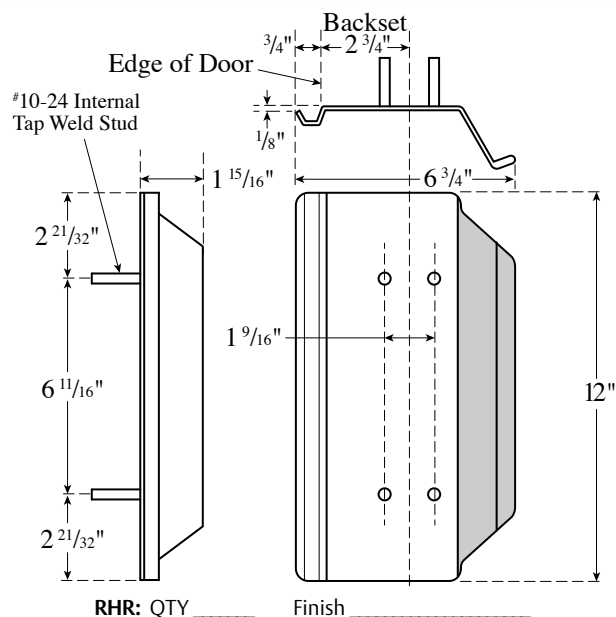
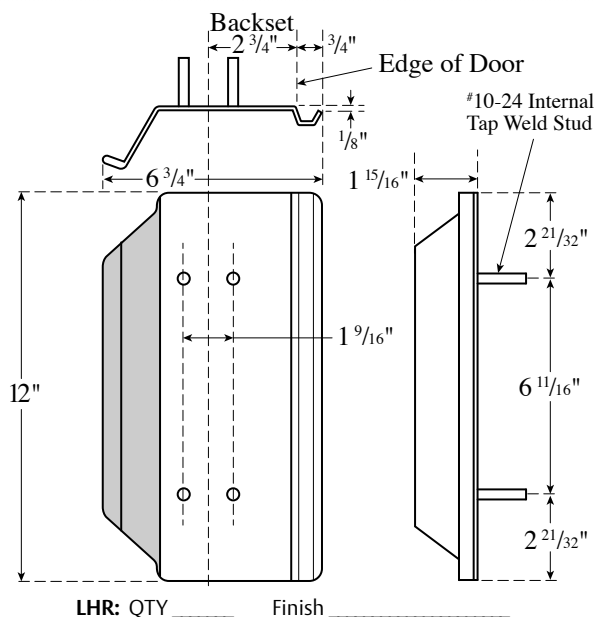

Note: If custom dimension please provide further information.

300 Main Street
Rockwood, Pennsylvania 15557
P: 800.458.2424 | F: 800.922.9212
www.assaabloydooraccessories.us | orders.rockwood@assaabloy.com

Copyright © 2018, ASSA ABLOY Accessories and Door Controls Group, Inc. All rights reserved. Reproduction in whole or in part without the express written permission of ASSA ABLOY Accessories and Door Controls Group, Inc. is prohibited.